

C1608NP01H562J080AA

TDK Item Description : C1608NP01H562JT****



Application & Main Feature

Commercial Grade (High Temperature Application)

Series

C1608 [EIA 0603]

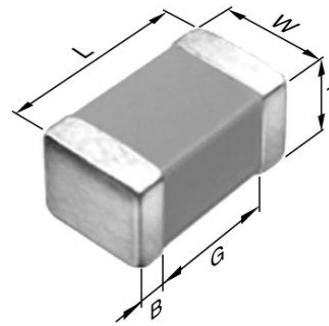

Dimensions

L	1.60mm ±0.10mm
W	0.80mm ±0.10mm
T	0.80mm ±0.10mm
B	0.20mm Min.
G	0.30mm Min.

Temperature Characteristic

NP0 (-55 to 150 degC 0+/-30ppm/degC)

Rated Voltage

1H(50Vdc)

Capacitance

5.6nF

Capacitance Tolerance

J (±5%)

Q Factor

1000 Min.

Insulation Resistance

10Gohm Min

AEC-Q200

Not Applicable

|Z|, ESR vs. Freq. Characteristics

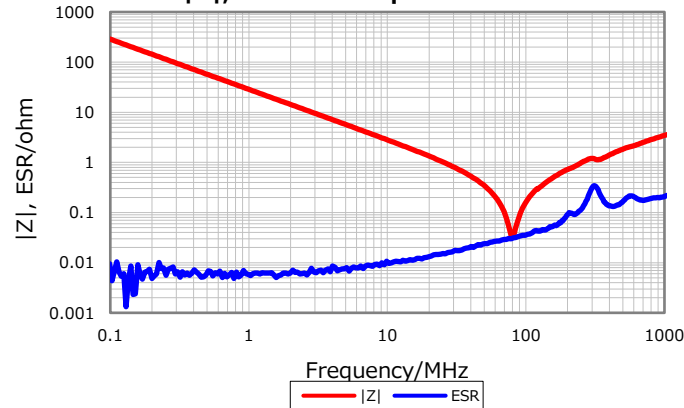

Cap. vs. Freq. Characteristic

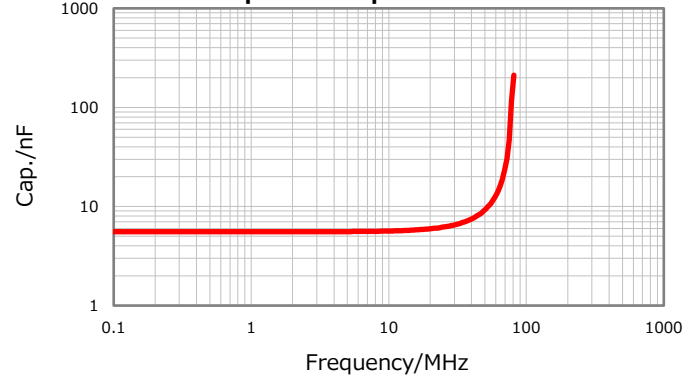

DC Bias Characteristic

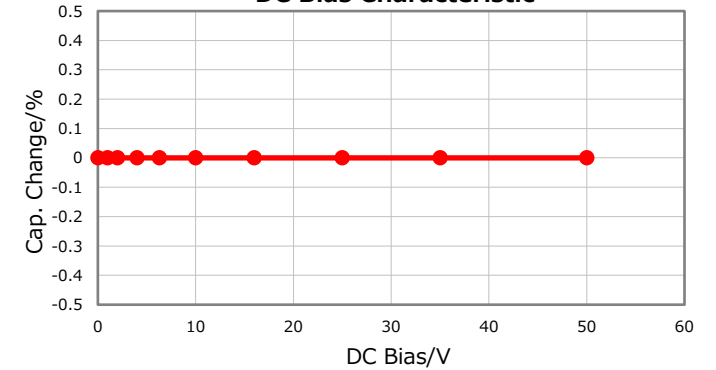

Temperature Characteristics

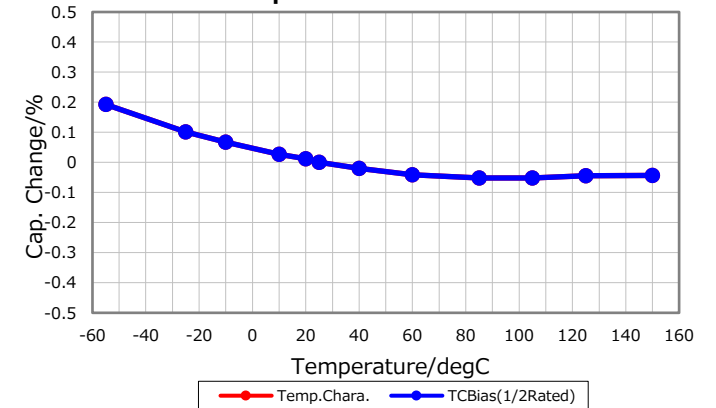

Ripple Temperature Rise Characteristics

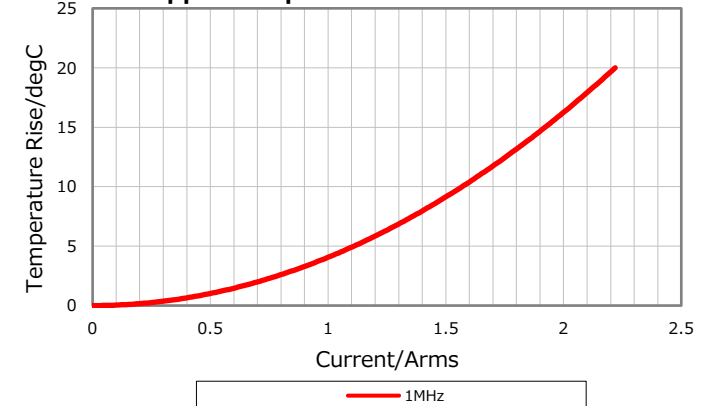

Characterization Sheet (Multilayer Ceramic Chip Capacitors)



All specifications are subject to change without notice.

May 21, 2019