

External LTE + Wi-Fi + GNSS COMBO ANTENNA



AECW0801C03

Request Samples



Check Inventory



Ø 81.3 x 16.3 mm
RoHS/RoHS II Compliant
MSL Level = 1

Features

- 3 cabled combo antenna
 - 1x 4G LTE
 - 1x Wi-Fi 2.4/5 GHz
 - 1x Active GNSS/GPS/GLONASS/BeiDou/QZSS
- Global 4G cellular band coverage including CAT M and NB-IoT
- IP67 rated
- Easy installation using Screw
- Fully customizable RF cable and connector options

Applications

- IoT
- M2M
- Smart City
- Telematics
- Transportation
- Smart Agriculture
- Geolocation and Tracking

Product Image



External LTE + Wi-Fi + GNSS COMBO ANTENNA



AECW0801C03

Request Samples



Check Inventory



Ø 81.3 x 16.3 mm
RoHS/RoHS II Compliant
 MSL Level = 1

Part Number Builder

AECW0801C03 □ - □□□□□

Color / UV Coating	
Code	Description
S (Standard)	Black without UV coating
A	Black with UV Coating
B	White without UV Coating
C	White with UV Coating

Cable length in 'mm'	
Maximum cable length supported : RG-174 (up to 3000 mm) LMR-100 (up to 5000 mm)	
Code	Description
3000 (Standard)	3000 mm
Other Examples :	
0200	200 mm
2000	2000 mm

Cable Type & Connector Type				
Code	Cable Type	Connector Type		
		LTE	GNSS	Wi-Fi
S (Standard)	RG-174	SMA (M)	SMA (M)	-
	LMR-100	-	-	SMA (M)
A	LMR-100	SMA (M)	SMA (M)	SMA (M)
B	LMR-100	SMA (M)	FAKRA C (F)	SMA (M)
C	LMR-100	FAKRA D (F)	SMA (M)	SMA (M)
D	LMR-100	FAKRA D (F)	FAKRA C (F)	SMA (M)
E	RG-174	SMA (M)	FAKRA C (F)	-
	LMR-100	-	-	SMA (M)
F	RG-174	FAKRA D (F)	SMA (M)	-
	LMR-100	-	-	SMA (M)
G	RG-174	FAKRA D (F)	FAKRA C (F)	-
	LMR-100	-	-	SMA (M)

Example Configurations :

Part Number	UV Protection Coating / Color	Cable length	Cable Type / Connector Type
AECW0801C03 S-3000S	No / Black	3000 mm	2xRG-174 with 1xSMA (M) for LTE + 1xSMA (M) for GNSS + 1xLMR-100 with 1xSMA (M) for Wi-Fi (Standard)
AECW0801C03 A-1000A	Yes / Black	1000 mm	3xLMR-100 with 1xSMA (M) for LTE + 1xSMA (M) for GNSS + 1xSMA (M) for Wi-Fi
AECW0801C03 B-5000G	No / White	5000 mm	2xRG-174 with 1xFAKRA D (F) for LTE + 1xFAKRA C (F) for GNSS + 1xLMR-100 with 1xSMA (M) for Wi-Fi

Note :

- For the standard part number (AECW0801C03**S-3000S**), please refer to the packaging at the end of the document
- For additional configuration (AECW0801C03□- □□□□□), MOQs, pricing and packaging changes may be applicable

External LTE + Wi-Fi + GNSS COMBO ANTENNA



AECW0801C03

Request Samples



Check Inventory



Ø 81.3 x 16.3 mm
RoHS/RoHS II Compliant
 MSL Level = 1

Electrical Specifications

Parameter	Specification			Unit
	Min	Typ	Max	
GNSS Antenna				
Frequency	1561		1602	MHz
Gain			2.0	dBiC
VSWR			1.5	
Impedance		50		Ω
Polarization	RHCP			
Axial Ratio			3.0	dB
LNA				
Noise Figure			1.5	dB
Gain	26	28	30	dB
VSWR			2.0	
Supply Voltage	2.2		5.0	V
Current Consumption			15.0	mA
LTE Antenna				
Frequency	698		960	MHz
	1710		2690	
VSWR			3.0	
Gain			2.0	dBi
Impedance		50		Ω
Polarization	Linear			
Wi-Fi Antenna				
Frequency	2400		2483.5	MHz
	4900		5825	
VSWR			2.5	
Gain			2.0	dBi
Impedance		50		Ω
Polarization	Linear			

Mechanical Specifications

Parameter	Specification
Antenna Dimension	Ø 81.3 x 16.3 mm
Material	ABS
Mounting Type	Screw
RF Connector	3x SMA (M)
RF Cable	2x RG-174 (LTE,GNSS) + 1x LMR-100 (Wi-Fi)
Cable Length	3 m



5101 Hidden Creek Ln Spicewood TX 78669
 Phone: 512-371-6159 | Fax: 512-351-8858
 For terms and conditions of sales, please visit:
www.abracon.com

REVISED: 05-08-20

ABRACON IS
 ISO9001-2015
 CERTIFIED

External LTE + Wi-Fi + GNSS COMBO ANTENNA



AECW0801C03

Request Samples



Check Inventory



Ø 81.3 x 16.3 mm
RoHS/RoHS II Compliant
MSL Level = 1

Environmental Specification

Parameter	Specification
Operating Temperature	-40°C to +85°C
Storage Temperature	-40°C to +85°C
Relative Humidity	Up to 95%
RoHS Compliance	Yes
PB Free	Yes
MSL	1
ESD Sensitive	Yes
Vibration	10 ~ 55 Hz with 1.5 mm amplitude 2 hrs
Ingress Protection	IP67 (excluding cable outlet)
UL rating	UL-94 HB

Product Dimension

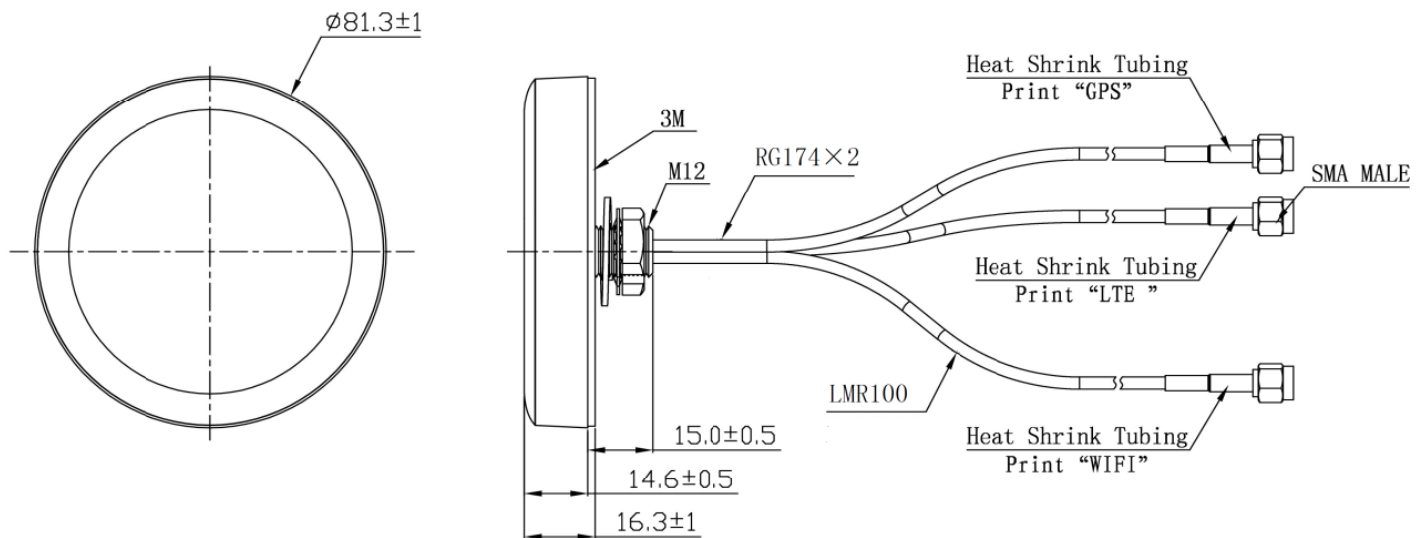

Unit: mm



5101 Hidden Creek Ln Spicewood TX 78669
 Phone: 512-371-6159 | Fax: 512-351-8858
 For terms and conditions of sales, please visit:
www.abracon.com

REVISED: 05-08-20

ABRACON IS
 ISO9001-2015
 CERTIFIED

External LTE + Wi-Fi + GNSS COMBO ANTENNA



AECW0801C03

Request Samples



Check Inventory



Ø 81.3 x 16.3 mm
RoHS/RoHS II Compliant
MSL Level = 1

Test Measurement - VSWR

GNSS Antenna

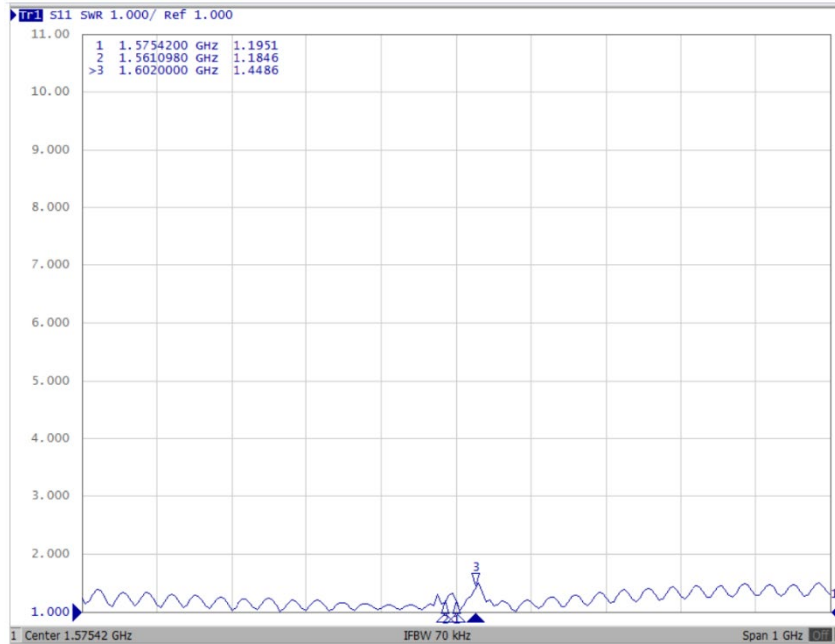

LTE Antenna

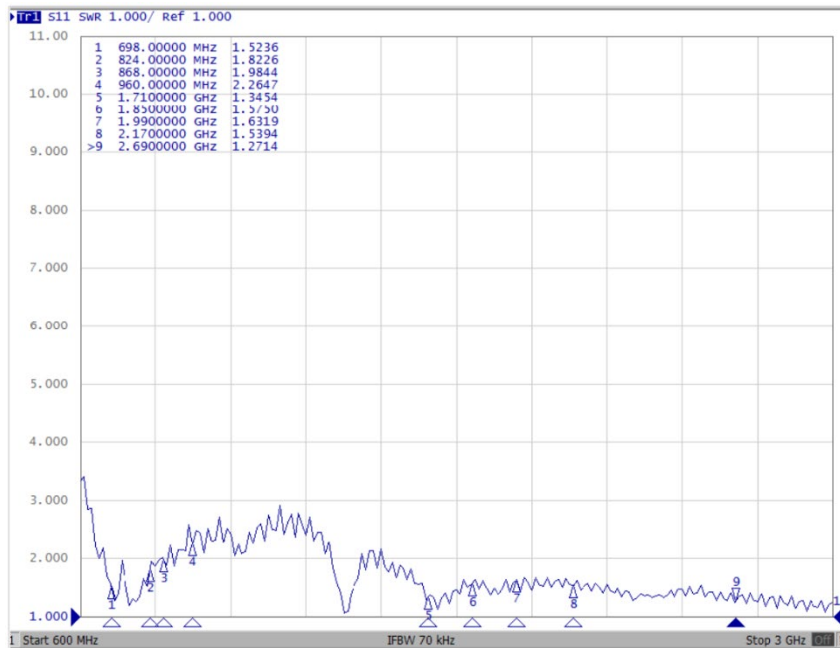

External LTE + Wi-Fi + GNSS COMBO ANTENNA



AECW0801C03

Request Samples



Check Inventory



Ø 81.3 x 16.3 mm
RoHS/RoHS II Compliant
MSL Level = 1

Wi-Fi Antenna

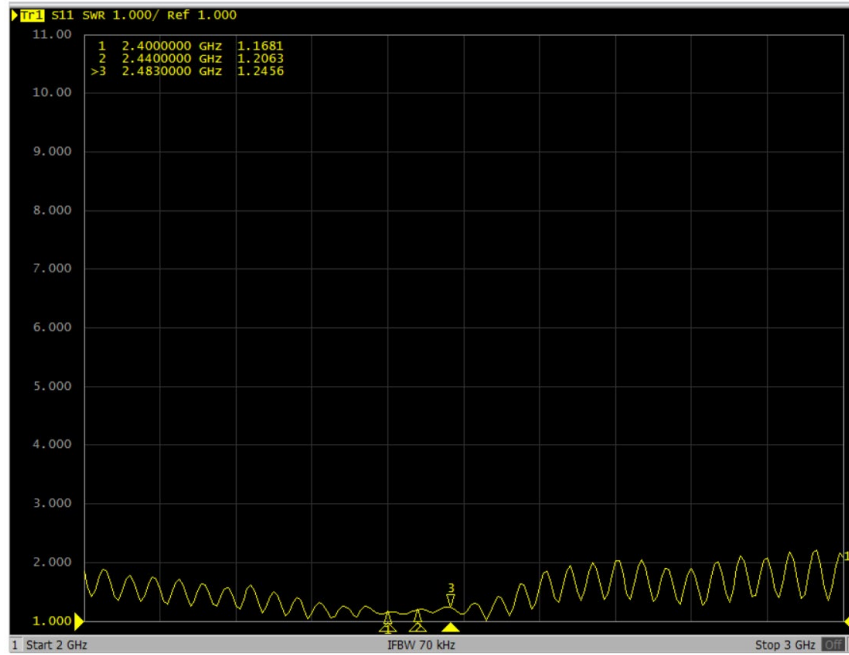

External LTE + Wi-Fi + GNSS COMBO ANTENNA



AECW0801C03

Request Samples



Check Inventory



Ø 81.3 x 16.3 mm
RoHS/RoHS II Compliant
MSL Level = 1

Radiation Characteristics

2D Pattern

GNSS

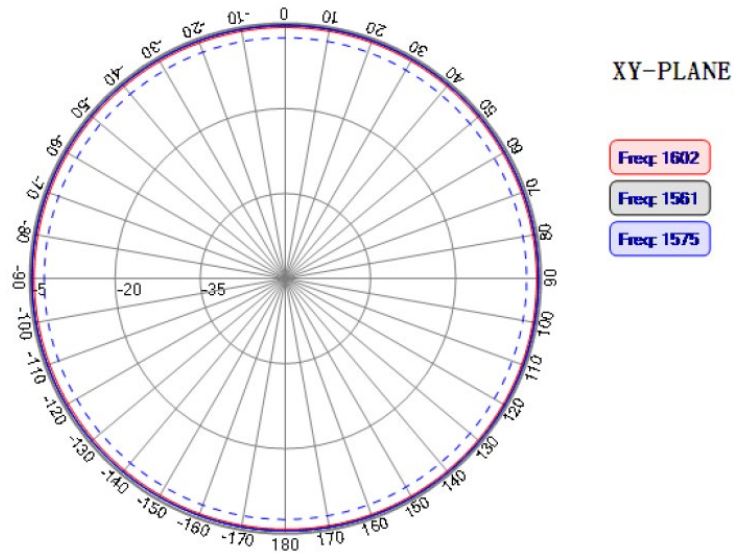

XZ-PLANE

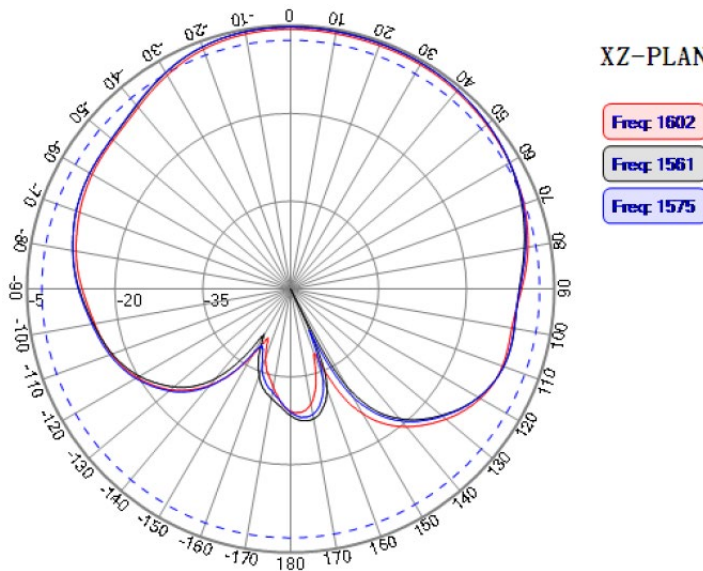

YZ-PLANE

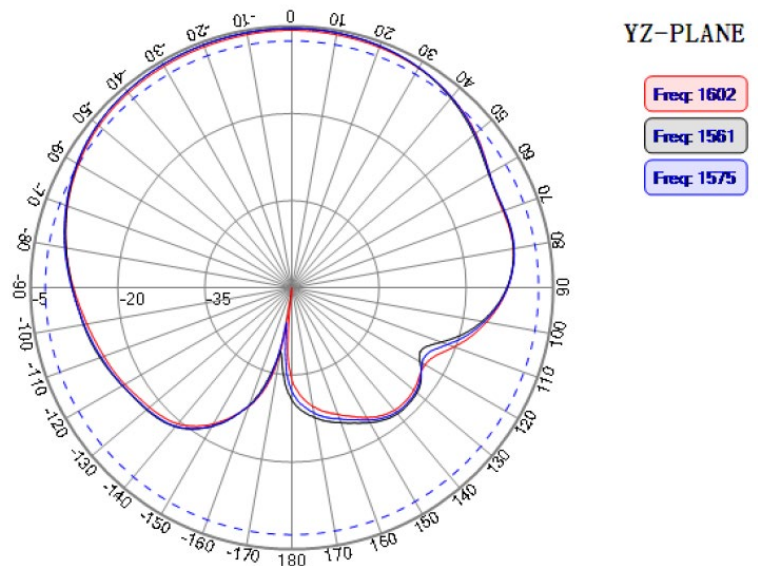

5101 Hidden Creek Ln Spicewood TX 78669
Phone: 512-371-6159 | Fax: 512-351-8858
For terms and conditions of sales, please visit:
www.abracon.com

REVISED: 05-08-20

ABRACON IS
ISO9001-2015
CERTIFIED

External LTE + Wi-Fi + GNSS COMBO ANTENNA



AECW0801C03

Request Samples



Check Inventory



Ø 81.3 x 16.3 mm
RoHS/RoHS II Compliant
MSL Level = 1

LTE

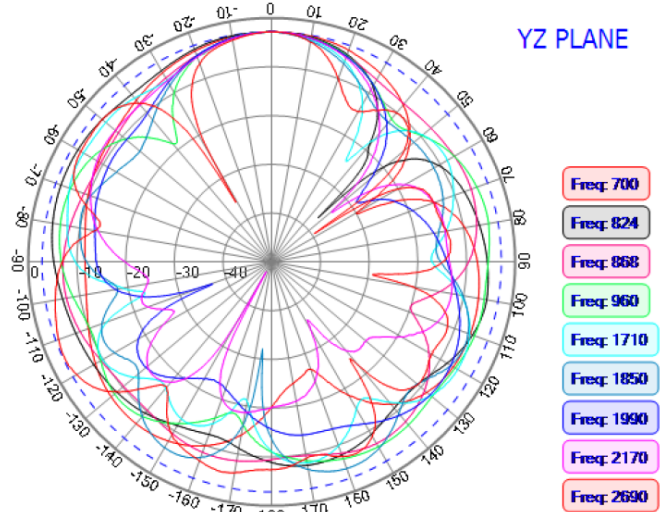
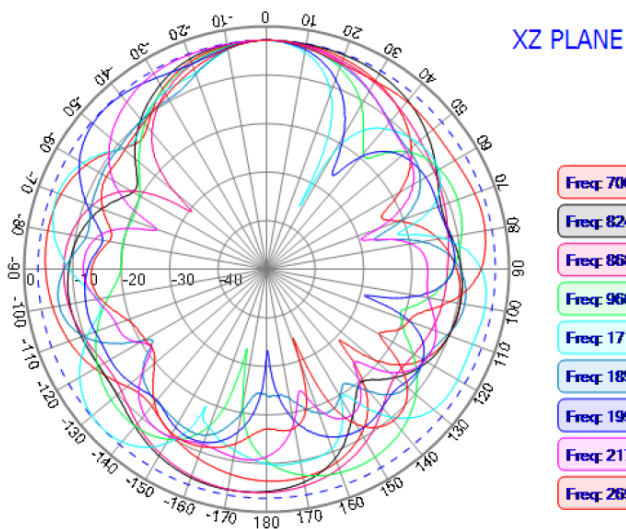
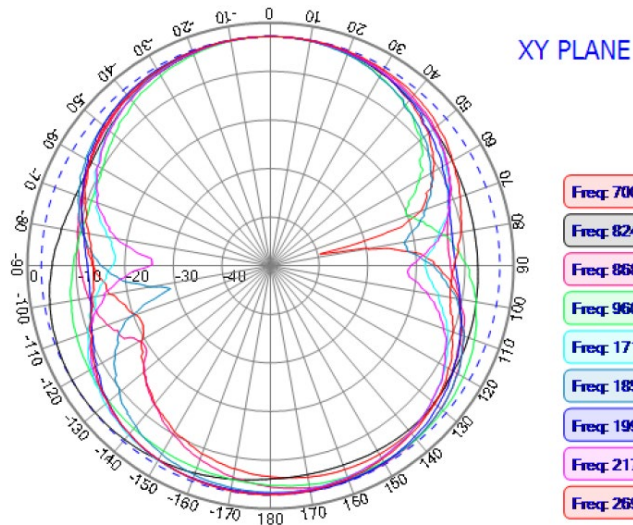

5101 Hidden Creek Ln Spicewood TX 78669
Phone: 512-371-6159 | Fax: 512-351-8858
For terms and conditions of sales, please visit:
www.abracon.com

REVISED: 05-08-20

ABRACON IS
ISO9001-2015
CERTIFIED

External LTE + Wi-Fi + GNSS COMBO ANTENNA



AECW0801C03

Request Samples



Check Inventory



Ø 81.3 x 16.3 mm
RoHS/RoHS II Compliant
MSL Level = 1

Wi-Fi

2400~2483.5 MHz

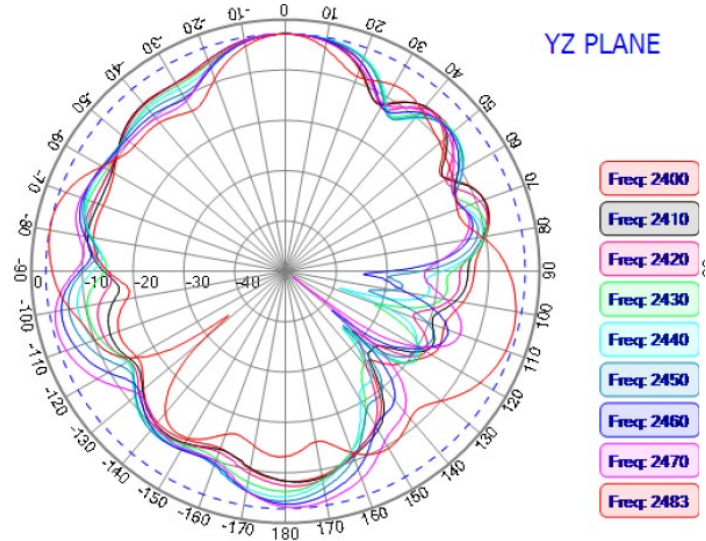
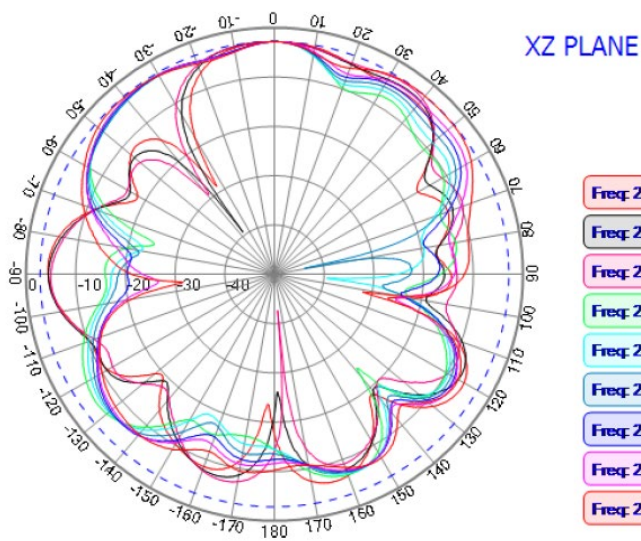
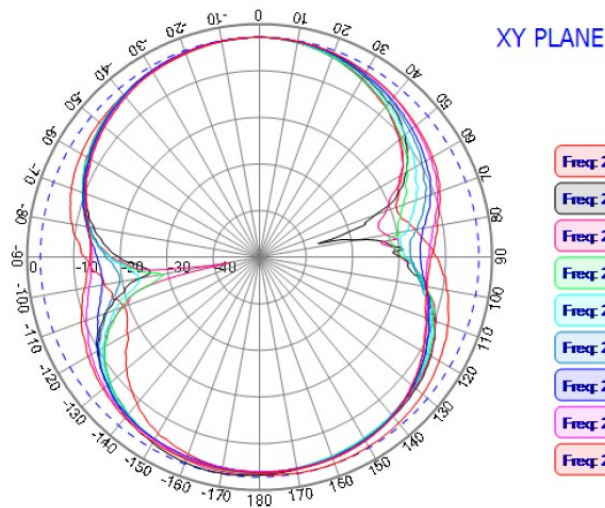

5101 Hidden Creek Ln Spicewood TX 78669
Phone: 512-371-6159 | Fax: 512-351-8858
For terms and conditions of sales, please visit:
www.abracon.com

REVISED: 05-08-20

ABRACON IS
ISO9001-2015
CERTIFIED

External LTE + Wi-Fi + GNSS COMBO ANTENNA



AECW0801C03

Request Samples



Check Inventory



Ø 81.3 x 16.3 mm
RoHS/RoHS II Compliant
MSL Level = 1

4900~5800 MHz

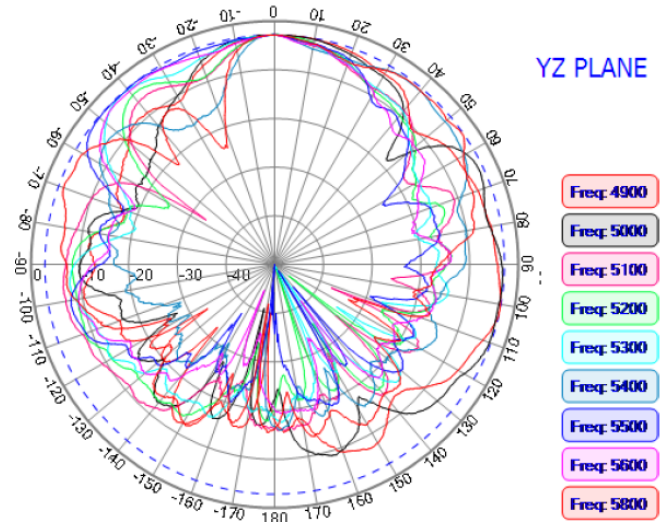
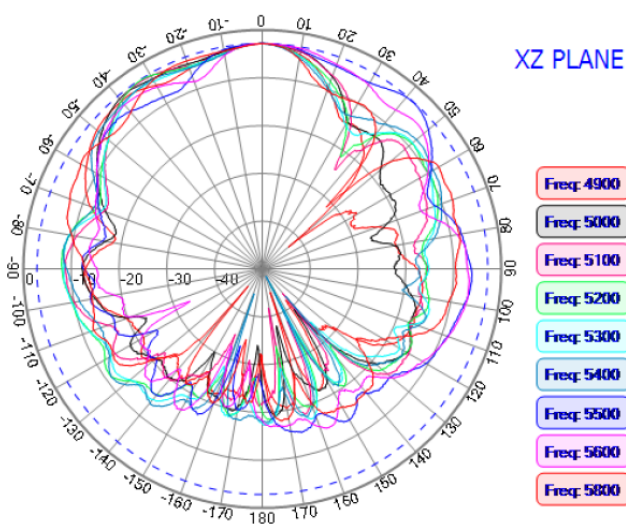
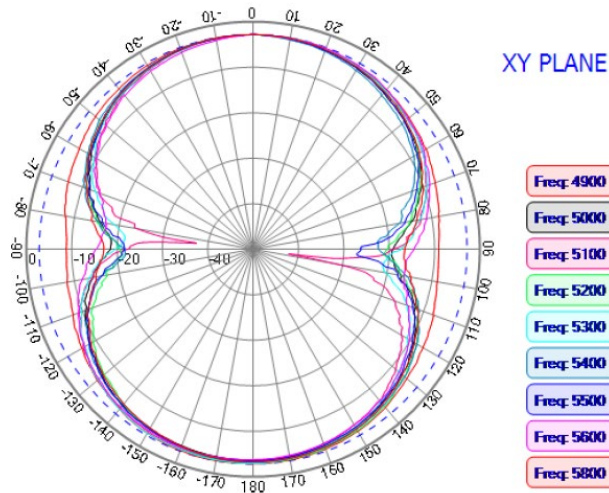

5101 Hidden Creek Ln Spicewood TX 78669
Phone: 512-371-6159 | Fax: 512-351-8858
For terms and conditions of sales, please visit:
www.abracon.com

REVISED: 05-08-20

ABRACON IS
ISO9001-2015
CERTIFIED

External LTE + Wi-Fi + GNSS COMBO ANTENNA



AECW0801C03

Request Samples



Check Inventory



Ø 81.3 x 16.3 mm
RoHS/RoHS II Compliant
MSL Level = 1

3D Pattern

GNSS

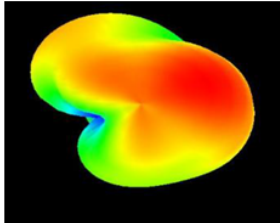

1561 MHz

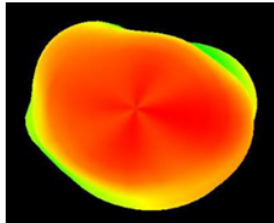

1575 MHz

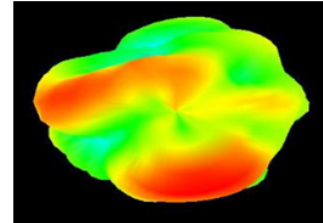

1602 MHz

LTE

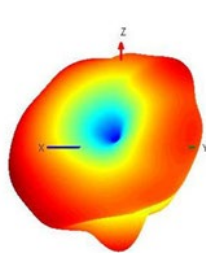

LTE 698 MHz

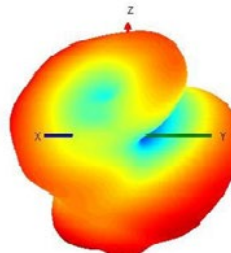

LTE 824 MHz

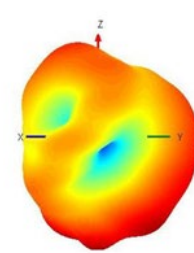

LTE 868 MHz

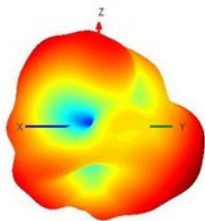

LTE 960 MHz

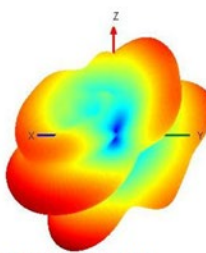

LTE 1710 MHz

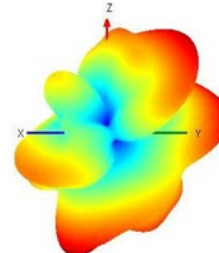

LTE 1850 MHz

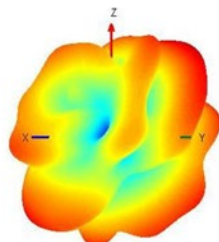

LTE 1990 MHz

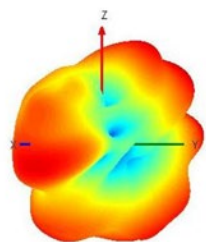

LTE 2170 MHz

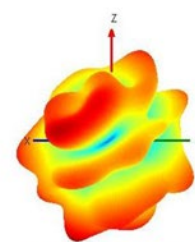

LTE 2690 MHz

External LTE + Wi-Fi + GNSS COMBO ANTENNA



AECW0801C03

Request Samples



Check Inventory



Ø 81.3 x 16.3 mm
RoHS/RoHS II Compliant
MSL Level = 1

Wi-Fi

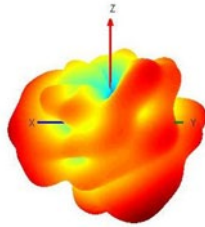

WiFi 2400 MHz

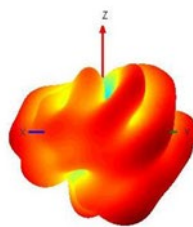

WiFi 2440 MHz

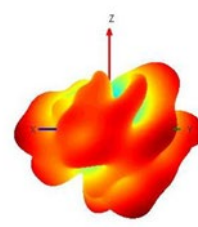

WiFi 2483 MHz

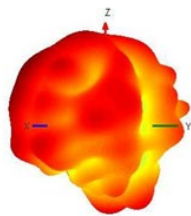

WiFi 4900 MHz

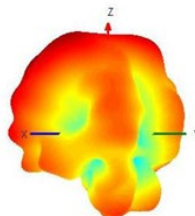

WiFi 5200 MHz

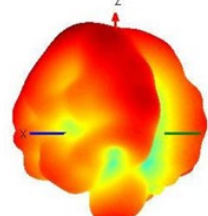

WiFi 5400 MHz

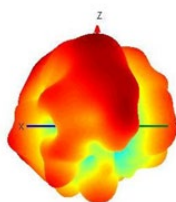

WiFi 5600 MHz

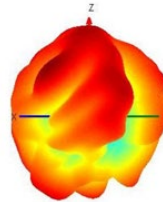

WiFi 5825 MHz

External LTE + Wi-Fi + GNSS COMBO ANTENNA



AECW0801C03

Request Samples



Check Inventory



Ø 81.3 x 16.3 mm
RoHS/RoHS II Compliant
MSL Level = 1

Gain and Efficiency

Frequency (MHz)	Gain (dBi)	Efficiency
698	1.73	0.69
824	1.28	0.58
868	1.32	0.55
960	1.1	0.54
1710	2.11	0.57
1850	0.32	0.52
1990	0.75	0.57
2170	1.97	0.59
2690	1.94	0.58
2400	2.11	0.52
2440	1.59	0.52
2483	1.93	0.54
4900	-0.15	0.54
5200	-2.23	0.48
5400	-1.81	0.49
5600	0.48	0.47
5825	0.53	0.47

Packaging Information

Number of Antenna/ Carton : 50
Dimension of the Carton : 700 x 320 x 155 mm
Weight of 1pc of antenna : 220 g
Weight of the carton : 12 kg

ATTENTION: Abracon LLC's products are COTS – Commercial-Off-The-Shelf products; suitable for Commercial, Industrial and, where designated, Automotive Applications. Abracon's products are not specifically designed for Military, Aviation, Aerospace, Life-dependent Medical applications or any application requiring high reliability where component failure could result in loss of life and/or property. For applications requiring high reliability and/or presenting an extreme operating environment, written consent and authorization from Abracon LLC is required. Please contact Abracon LLC for more information.



5101 Hidden Creek Ln Spicewood TX 78669
Phone: 512-371-6159 | Fax: 512-351-8858
For terms and conditions of sales, please visit:
www.abracon.com

REVISED: 05-08-20

ABRACON IS
ISO9001-2015
CERTIFIED