

NON-ISOLATED DC/DC CONVERTERS

4.5 Vdc - 13.8 Vdc Input 0.591 Vdc - 5.1 Vdc/20 A Output

Apr. 16, 2010

Bel Power Inc., a subsidiary of Bel Fuse Inc.

xRP1-20E1A0

RoHS Compliant

Rev. I

- Non-Isolated
- High Efficiency
- Fixed Switching Frequency
- Low Cost
- Excellent Thermal Performance
- Wide Input Voltage Range
- Wide Output Trim Range
- Output Over-Voltage Shutdown
- OCP/SCP
- Low Output Ripple
- Power Good Signal
- Remote On/Off



Description

The xRP1-20E1A0 is a non-isolated dc/dc converter that operates over a wide range of input voltage ($V_{in} = 4.5 \text{ Vdc} \sim 13.8 \text{ Vdc}$). This unit can provide a precisely regulated output voltage from 0.591 Vdc to 5.1 Vdc and can deliver up to 20 A of output current. This unit is designed to be highly efficient and low cost. The converter is provided in an industry standard package.

Part Selection

Output Voltage	Input Voltage	Max. Output Current	Max. Output Power	Typical Efficiency ($V_o=5.0 \text{ Vdc}$)	Model Number Active High
0.591 Vdc - 5.1 Vdc	4.5 Vdc - 13.8 Vdc	20 A	100 W	94%	VRP1-20E1A0
0.591 Vdc - 5.1 Vdc	4.5 Vdc - 13.8 Vdc	20 A	100 W	94%	ORP1-20E1A0

- Notes:**
1. The part number first letter "V" indicate Vertical mount and "O" indicate Horizontal mount.
 2. All part numbers above indicate RoHS 6. Change the second letter "R" to "7" for RoHS 5 part numbers.
 3. Add "G" suffix at the end of the model numbers listed above to indicate "Tray Packaging".

Absolute Maximum Ratings

Parameter	Min	Typ	Max	Notes
Input Voltage (continuous)	-0.3 V	-	15 V	
Output Enable Terminal Voltage	-0.3 V	-	15 V	
Ambient Temperature	0 °C	-	70 °C	
Storage Temperature	-40 °C	-	125 °C	

Input Specifications

Parameter	Min	Typ	Max	Notes	
Input Voltage	$V_o < 3.45 \text{ V}$ $V_o \geq 3.45 \text{ V}$	4.5 V $1.3 \cdot V_o$	12 V 12 V	13.8 V 13.8 V	
Input Current (full load)	-	-	20 A	An input line fuse must always be used.	
Input Current (No load)	-	150 mA	300 mA		
Remote Off Input Current	-	50 mA	-		
Input Reflected Ripple Current (pk-pk)	-	50 mA	100 mA	Use a 1000uF AL-Cap on the input.	
Input Reflected Ripple Current (rms)	-	20 mA	40 mA		
I^2t Inrush Current Transient	-	-	1 A ² s		
Turn-on Voltage Threshold	-	4.2 V	-	A 30.1K resistor is connected from Enable to Vin	
Turn-off Voltage Threshold	-	3.9 V	-		

Note: All specifications are typical at 25 °C unless otherwise stated.

NON-ISOLATED DC/DC CONVERTERS

4.5 Vdc - 13.8 Vdc Input 0.591 Vdc - 5.1 Vdc/20 A Output



Apr. 16, 2010

Bel Power Inc., a subsidiary of Bel Fuse Inc.

Output Specifications

Parameter	Min	Typ	Max	Notes
Output Voltage Set Point Accuracy	-1.5 % Vo	-	+1.5 % Vo	Vin=12 V, Iout=half load
Load Regulation	-	-	1% Vo	
Line Regulation	-	-	0.5% Vo	
Regulation Over Temperature (0 °C to +70 °C)	-	-	1% Vo	
Output Current	0 A	-	20 A	
Current Limit Threshold	-	150% Iomax	-	
Output Ripple and Noise (pk-pk)	-	40 mV	80 mV	Test conditions: 0-20MHz BW, with a 1µF ceramic capacitor and a 10uF Tantalum cap at output.
Output Ripple and Noise (rms)	-	20 mV	40 mV	
Short Circuit Surge Transient	-	1 A ² s	3 A ² s	
Turn On Time	-	2 mS	10 mS	
Overshoot at Turn on and off	-	-	5%	
Output Capacitance	0 uF	-	1000 uF	
Transient Response				
50% ~ 75% Max Load	Vo=All	-	200 mV	Test conditions: di/dt = 2.5 A/uS; Vin =12 V; with 10 uF tantalum cap and 1 uF ceramic at the output, Ta=25 °C
Settling Time		-	50 uS	
75% ~ 50% Max Load		-	200 mV	
Settling Time		-	50 uS	

Note: All specifications are typical at 25 °C unless otherwise stated.

General Specifications

Parameter	Min	Typ	Max	Notes
Efficiency Vo=5.0 V Vo=3.3 V Vo=2.5 V Vo=1.5 V Vo=0.591 V	- - - - -	94% 92% 90% 85% 70%	- - - - -	Measured at Vin=12 V, full load.
Switching Frequency	-	500 kHz	-	
Output Voltage Trim Range	0.591 V	-	5.1 V	
Remote Sense Compensation	-	-	0.2 V	Vin=12 V, Io=full load.
MTBF	TBD			Calculated Per Bell Core SR-332 (Io = 80%Iomax; Vin=12 V; Ta = 25 °C)
Dimensions Inches (L x W x H) Millimeters (L x W x H)	1.45 x 0.61 x 0.40 36.83 x 15.49 x 10.15			VRP1-20E1A0
Dimensions Inches (L x W x H) Millimeters (L x W x H)	1.45 x 0.61 x 0.50 36.83 x 15.49 x 12.69			ORP1-20E1A0
Weight	-	9.7 g	-	

Note: All specifications are typical at 25 °C unless otherwise stated.

NON-ISOLATED DC/DC CONVERTERS

4.5 Vdc - 13.8 Vdc Input 0.591 Vdc - 5.1 Vdc/20 A Output



Apr. 16, 2010

Bel Power Inc., a subsidiary of Bel Fuse Inc.

Control Specifications

Parameter	Min	Typ	Max	Notes
Remote On/Off (Active High)				
Signal Low (Unit Off)	-0.3 V	-	0.4 V	Remote On/Off pin is open, unit is off.
Signal High (Unit On)	2 V	-	5.5 V	
PwGood (PowerGood)				
PwGood = High = Power Good	2.4 V	-	6 V	
	-	-	2 mA	
PwGood = Low = Power Not Good	0 V	-	0.35 V	
	-	-	5 mA	

Output Trim Equation

The Rtrim resistor should be connected between the Trim pin and GND pin.

$$R_{trim} = \left[\frac{1.182}{V_o - 0.591} \right] \text{ k}\Omega$$

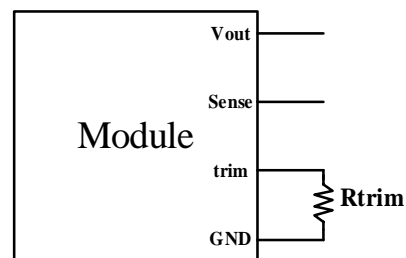

NON-ISOLATED DC/DC CONVERTERS

4.5 Vdc - 13.8 Vdc Input 0.591 Vdc - 5.1 Vdc/20 A Output



Apr. 16, 2010

Bel Power Inc., a subsidiary of Bel Fuse Inc.

Efficiency Data

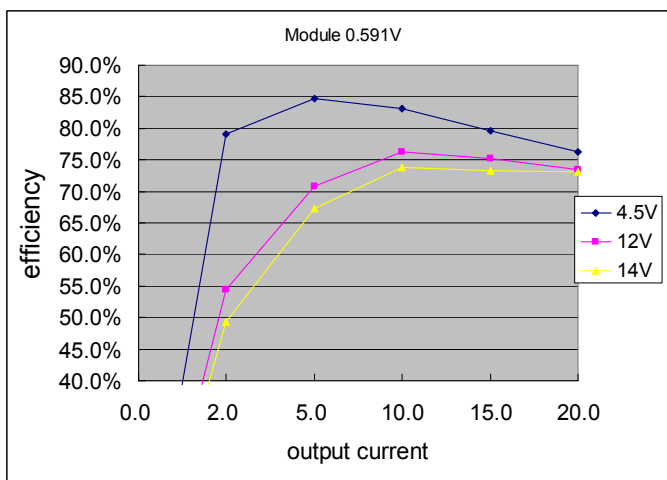
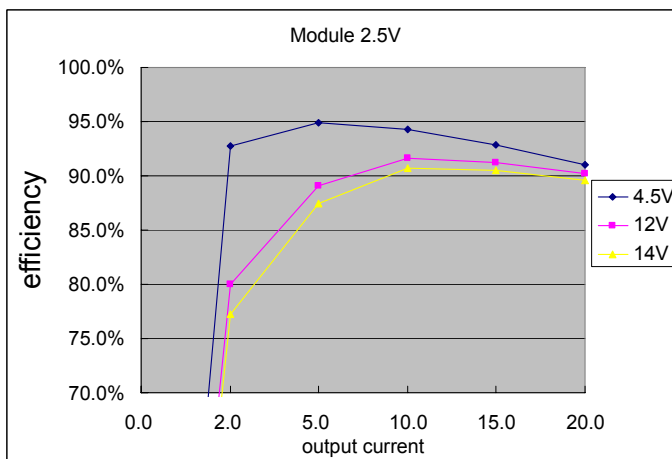
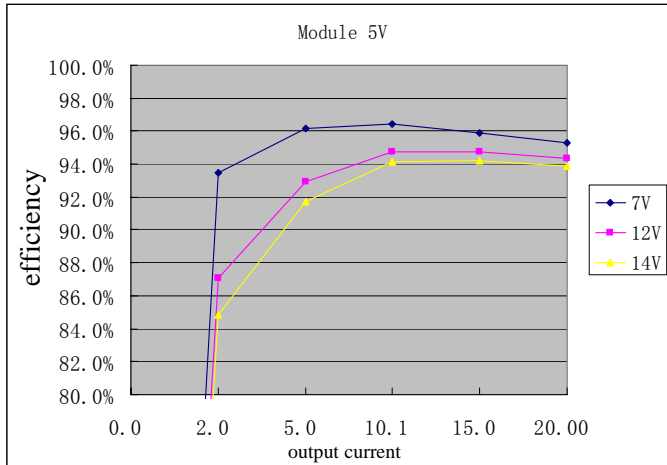

NON-ISOLATED DC/DC CONVERTERS

4.5 Vdc - 13.8 Vdc Input 0.591 Vdc - 5.1 Vdc/20 A Output



Apr. 16, 2010

Bel Power Inc., a subsidiary of Bel Fuse Inc.

Thermal Derating Curves

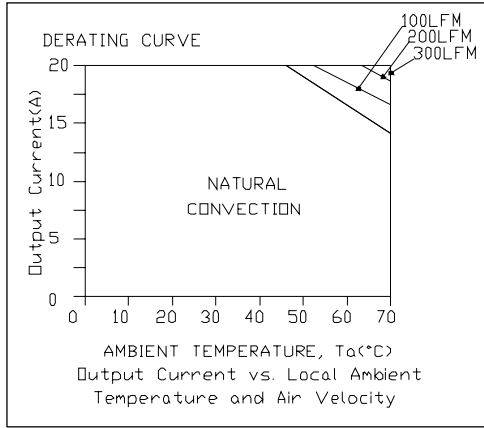

Vout=0.591V

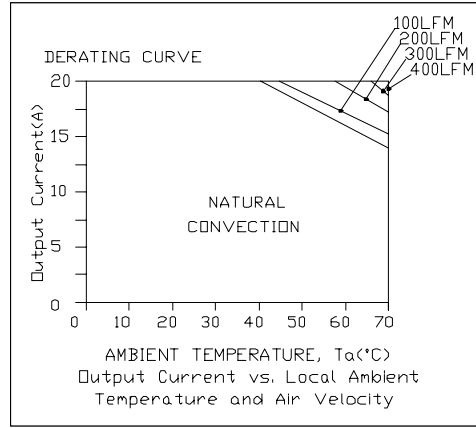

Vout=1.2 V

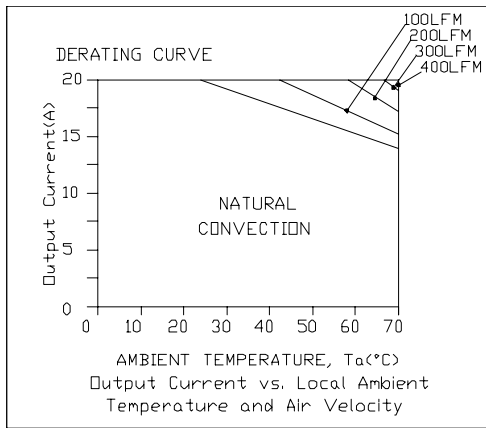

Vout=2.5 V

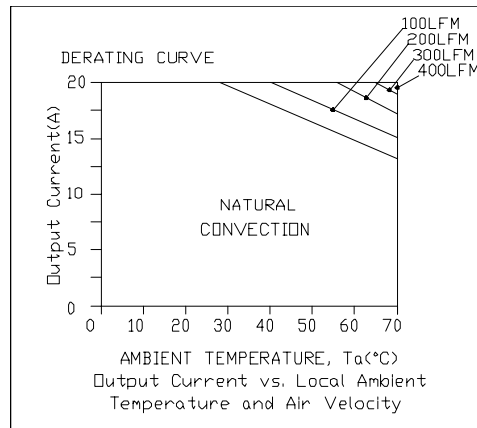

Vout=3.3 V

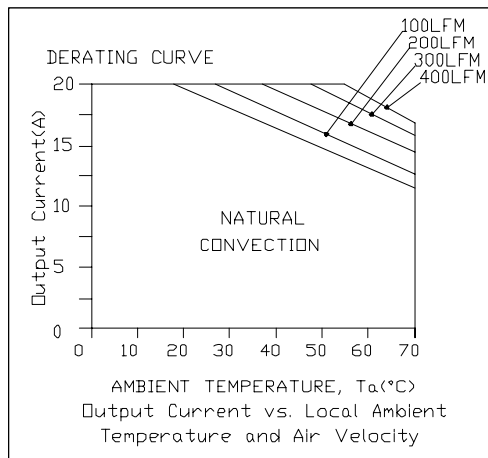

Vout=5 V

NON-ISOLATED DC/DC CONVERTERS

4.5 Vdc - 13.8 Vdc Input 0.591 Vdc - 5.1 Vdc/20 A Output



Apr. 16, 2010

Bel Power Inc., a subsidiary of Bel Fuse Inc.

Ripple and Noise Waveforms

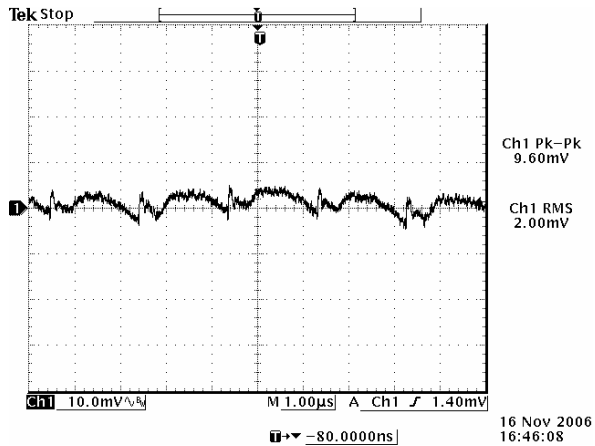

12 Vdc input, 0.591 Vdc output

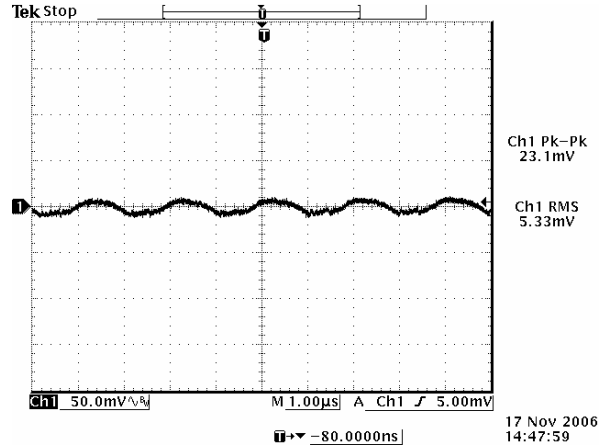

12 Vdc input, 2.5 Vdc output

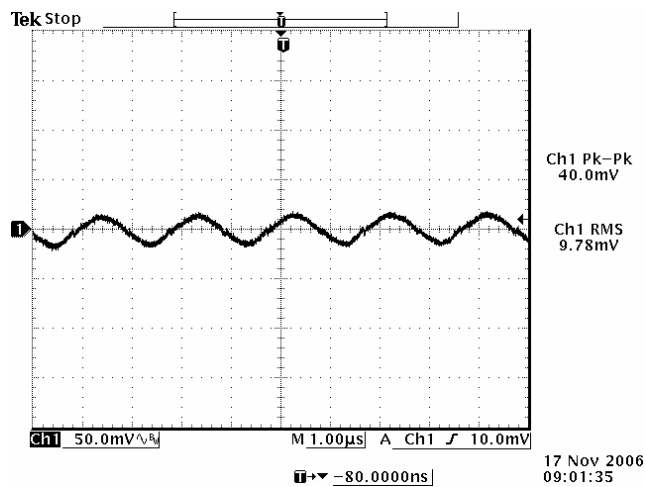

12 Vdc input, 5 Vdc output

Note: Ripple and noise at full load, 0-20 MHz BW, with a 10 uF tantalum cap and a 1 uF ceramic cap, and $T_a=25$ deg C.

NON-ISOLATED DC/DC CONVERTERS

4.5 Vdc - 13.8 Vdc Input 0.591 Vdc - 5.1 Vdc/20 A Output



Apr. 16, 2010

Bel Power Inc., a subsidiary of Bel Fuse Inc.

Transient Response Waveforms

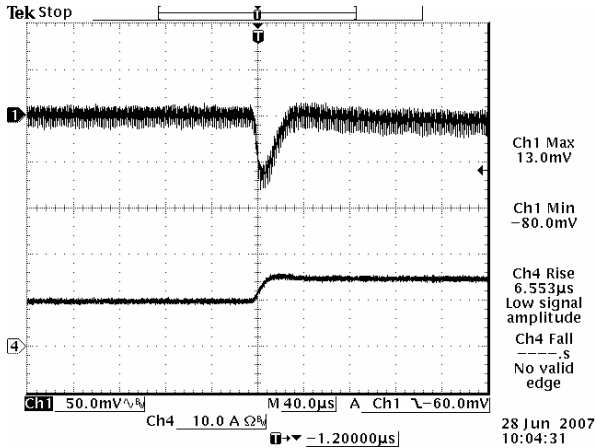

Vout= 2.5 V 50%-75% Load Transients

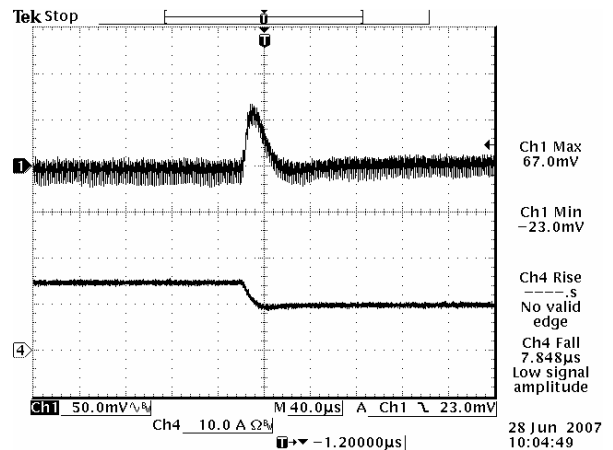

Vout=2.5 V 75%-50% Load Transients

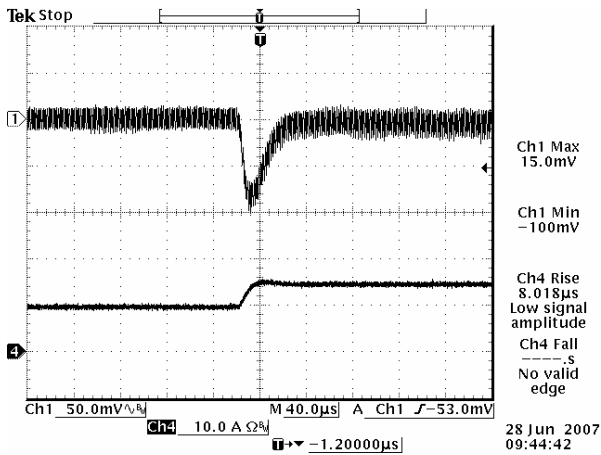

Vout= 5 V 50%-75% Load Transients

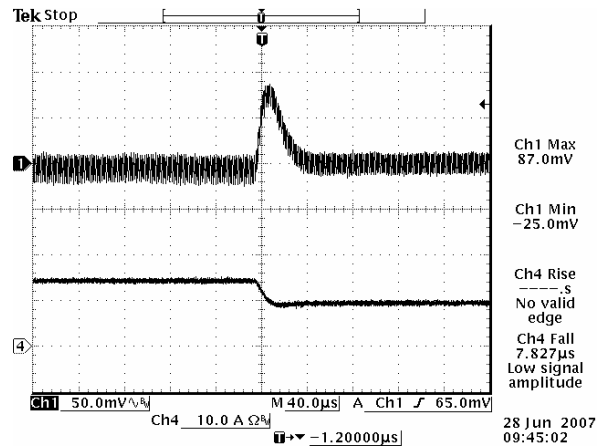

Vout=5 V 75%-50% Load Transients

Note: Transient response at $di/dt = 2.5 \text{ A}/\mu\text{S}$, with 1 μF ceramic capacitor at the output, and $T_a=25 \text{ deg C}$.

NON-ISOLATED DC/DC CONVERTERS

4.5 Vdc - 13.8 Vdc Input 0.591 Vdc - 5.1 Vdc/20 A Output



Apr. 16, 2010

Bel Power Inc., a subsidiary of Bel Fuse Inc.

Mechanical Outline

VRP1-20E1A0

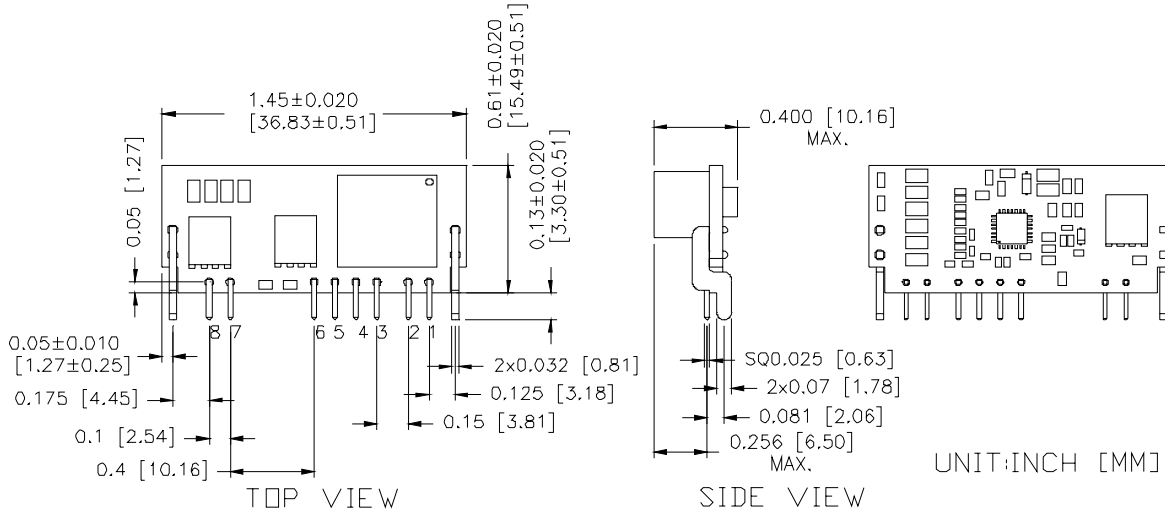

RECOMMENDED PCB LATOUT

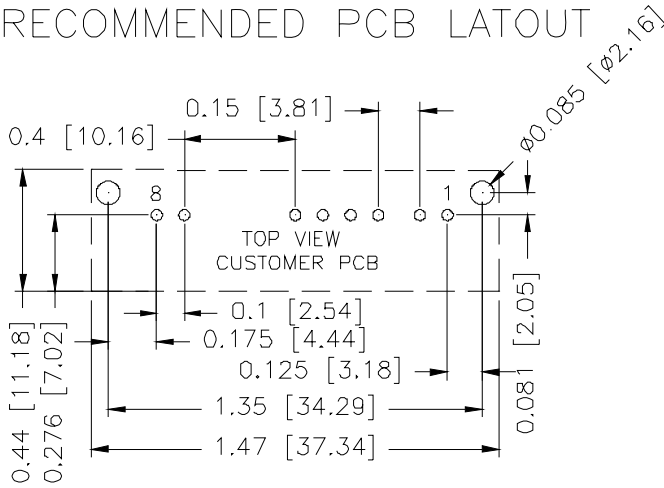

- 2 SUPPORT PAD HOLES: $\phi 0.085$ [2.16] BOTH SIDES
- 8 PIN PAD HOLES: $\phi 0.04$ [1.00] BOTH SIDES

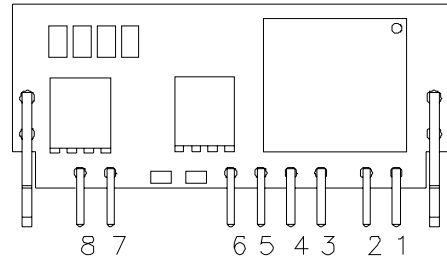

Pin Connections

Pin	Function
1	Vout
2	Trim
3	GND
4	PwGOOD
5	Enable
6	Vin
7	Sense+
8	Sense-

NON-ISOLATED DC/DC CONVERTERS

4.5 Vdc - 13.8 Vdc Input 0.591 Vdc - 5.1 Vdc/20 A Output



Apr. 16, 2010

Bel Power Inc., a subsidiary of Bel Fuse Inc.

Mechanical Outline (continued)

ORP1-20E1A0

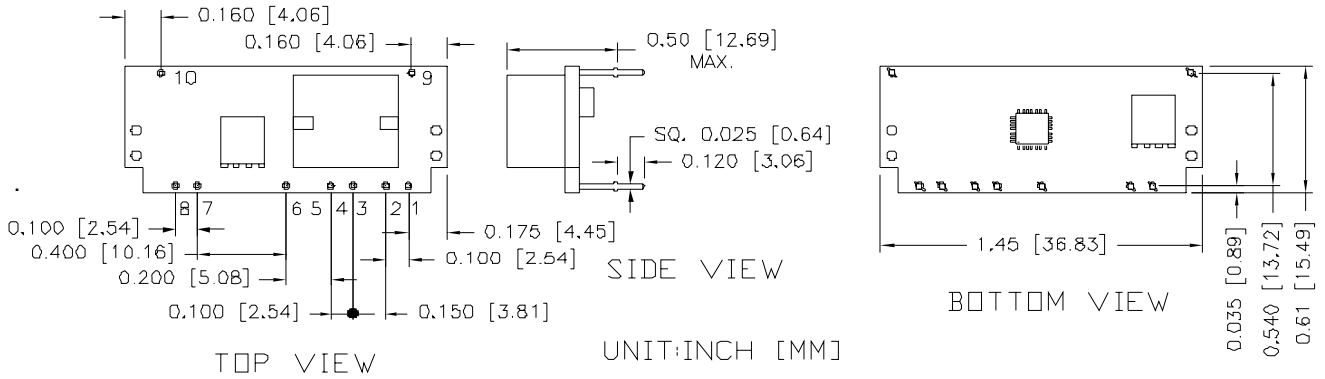

RECOMMENDED PCB LAYOUT

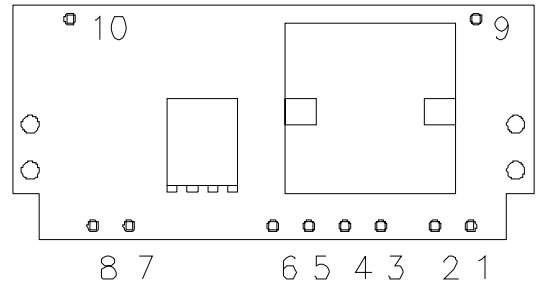
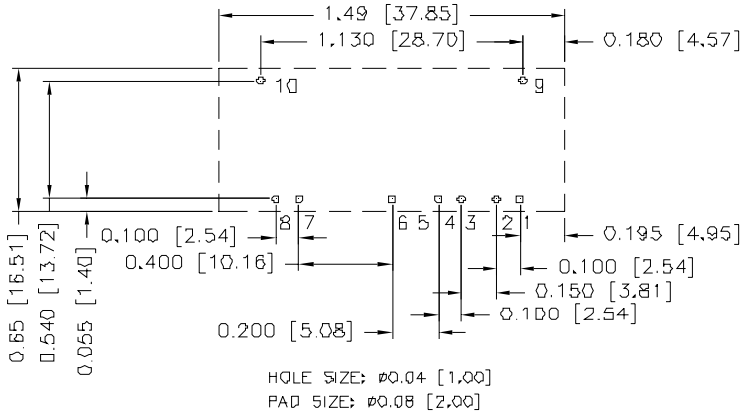

Pin Connections

Pin	Function
1	Vout
2	Trim
3	GND
4	PwGOOD
5	Enable
6	Vin
7	Sense+
8	Sense-
9	Mech Support(Ground)
10	Mech Support(Ground)

NON-ISOLATED DC/DC CONVERTERS

4.5 Vdc - 13.8 Vdc Input 0.591 Vdc - 5.1 Vdc/20 A Output



Apr. 16, 2010

Bel Power Inc., a subsidiary of Bel Fuse Inc.

Revision History

Date	Revision	Changes Detail	Approval
2010-4-16	I	Add part number ORP1-20E1A0	Jack Fan

RoHS Compliance

Complies with the European Directive 2002/95/EC, calling for the elimination of lead and other hazardous substances from electronic products.



©2010 Bel Fuse Inc. Specifications subject to change without notice. 041610

CORPORATE

Bel Fuse Inc.
206 Van Vorst Street
Jersey City, NJ 07302
Tel 201-432-0463
Fax 201-432-9542
www.belfuse.com

FAR EAST

Bel Fuse Ltd.
8F/ 8 Luk Hop Street
San Po Kong
Kowloon, Hong Kong
Tel 852-2328-5515
Fax 852-2352-3706
www.belfuse.com

EUROPE

Bel Fuse Europe Ltd.
Preston Technology Management Centre
Marsh Lane, Suite G7, Preston
Lancashire, PR1 8UD, U.K.
Tel 44-1772-556601
Fax 44-1772-888366
www.belfuse.com