

# Sure Cross® R70SR Serial Data Radio



## Datasheet



Sure Cross® R70SR Serial Data Radios are compact, industrial, low-power wireless communications devices used to extend the range of serial communications networks. The Serial Data Radios are available in two frequencies, 900 MHz and 2.4GHz, and are fitted with M12 quick disconnect connectors for fast deployment.

- RS-485 serial communication
- Star or tree network topology configuration
- DIP switches select operational modes
- Frequency Hopping Spread Spectrum (FHSS) technology ensures reliable data delivery
- Self-healing, auto-routing radio frequency network with multiple hops to extend the network's range

For additional information, updated documentation, and a list of accessories, refer to Banner Engineering's website, [www.bannerengineering.com](http://www.bannerengineering.com).

## Models

Models	Frequency	Transmit Power
R70SR9MQ	900 MHz ISM Band	1 Watt
R70SR2MQ	2.4 GHz ISM Band	65 mW (100 mW EIRP)

## Quick Start Guide

### Setting Up Your Serial Data Radio Network

To set up and install your wireless Serial Data Radio network, follow these steps:

1. Before installing your serial data radios, first verify that your serial devices work. Connect your serial devices using a serial cable. Note the baud rate and parity of your serial devices so that you can use the DIP switches to configure the serial data radios to use these parameters. Set your serial devices to 8 data bits and 1 stop bit.
2. Configure the DIP switches of all devices.
3. Apply power to all devices.
4. Form the wireless network by binding the repeater and slave radios to the master radio.
5. Observe the LED behavior to verify the devices are communicating with each other.
6. Install your wireless sensor network components. For more details about installing your radios, refer to the [Sure Cross Installation Guide](#) (p/n 151514) downloadable from the Wireless Reference Library at [www.bannerengineering.com](http://www.bannerengineering.com).

## Configuration Instructions

### Buttons and LEDs

Figure 1. Binding button, LEDs, and DIP switches

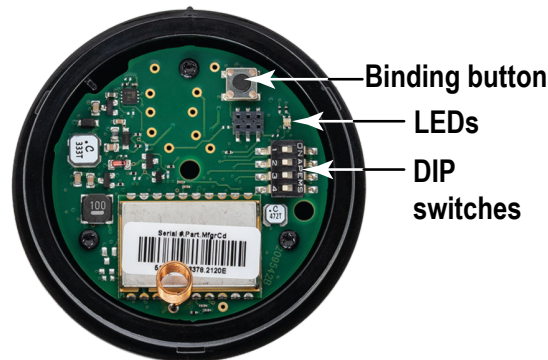

### Configure the DIP Switches

Before changing DIP switch positions, disconnect the power. Any changes made to the DIP switches are not recognized until after power is cycled to the device.

For devices powered by batteries integrated into the housing, triple-click button 2, then double-click button 2 to reset the device without removing the battery.



For parameters not set using the DIP switches, use the configuration software to make configuration changes. For parameters set using the DIP switches, the DIP switch positions override any changes made using the configuration software.

### Open the Cover

If the R70SR is in the locked position, the arrow on the cover is above the notch on the base. Follow these steps to unlock and remove the cover.

1. Rotate the cover counter clockwise so that the notches are aligned together.
2. Pull the top cover off.

### DIP Switch Settings

Device Settings	DIP Switches			
	1	2	3	4
Serial baud rate (19200); No parity (software default setting)	OFF			
Serial baud rate 9600; No parity	ON			
Routed mode (master to slave; repeater/slave to master) (default setting)		OFF		
Broadcast mode		ON		
Set this radio to be a slave radio (default setting) (900 MHz or 2.4 GHz models)			OFF	OFF
Set this radio to be a master radio <ul style="list-style-type: none"> <li>• 900 MHz models: Set to 1 W (30 dBm) transmit power</li> <li>• 2.4 GHz models: Transmit power remains at 65 mW</li> </ul>			OFF	ON
Set this radio to be a repeater radio (900 MHz or 2.4 GHz models)			ON	OFF
Set this radio to be a master radio <ul style="list-style-type: none"> <li>• 900 MHz models: Set to 250 mW (24 dBm) transmit power</li> <li>• 2.4 GHz models: Transmit power remains at 65 mW</li> </ul>			ON	ON

**Baud Rate and Parity**— Use the Baud Rate and Parity setting DIP switches to configure the radio's serial port. These settings must match the device wired to the radio's serial port. A faster baud rate setting may improve system response time. Changing the baud rate does NOT change the radio transmission rate. The Software default also provides the ability to set custom baud rate and timing parameter settings via AT commands. For more information, see the technical note [Changing the Baud Rate and Parity on an R70SR Serial Data Radio](#) (p/n b\_51173725).

**Routed Mode**—Use routed messaging when using a point-to-point or point-to-point-with-repeater topology. Routing is more robust and faster than broadcast messaging. In Routed mode, the radios will route serial data packets only to a single device. In general, this mode is for faster communications. If the Slave/Repeaters are in Routed mode, they will only route serial data packets to the Master and will only listen for serial data packets coming from the Master. If the Master radio is in Routed mode, it will only route serial data packets to the first Slave radio that comes into the network. The Master Radio should only be in Routed mode if used in a Point to Point Network.

**Broadcast Mode**—Broadcast mode allows for more flexible radio layouts and is used in the star and MultiHop tree topologies. These topologies are much more flexible but they are slower. When using broadcast mode, a small percentage of data packets will not be reach their destination. Broadcast mode requires the application layer to automatically retry packets that time out. In networks with multiple slaves, the master radio must use broadcast mode, but the slaves can be set to use routing mode to route their data packets back to the master radio. In Broadcast Mode, the radios will route serial data packets to all devices in the network. In general, this mode will have slower communication speeds but will allow for much more system flexibility. If the Slave/Repeaters are in Broadcast mode, they will route serial data packets to all other devices and will listen to serial data packets coming from all devices. If the Master radio is in Broadcast mode, it will route serial data packets to all Slave/Repeaters and listen to serial data packets coming from all devices.

**Transmit Power Levels**—The 900 MHz radios transmit at 1 Watt (30 dBm) or 250 mW (24 dBm). The 250 mW mode reduces the radio's range, which can help avoid cross talk in areas with multiple systems. For 2.4 GHz models, this DIP switch is disabled. The transmit power for 2.4 GHz is fixed at about 65 mW EIRP (18 dBm).

**Star Topology**—To configure your radios as a star topology, set one radio to be the master in broadcast mode (DIP switch 2 ON). Set all the other radios to be slaves, also in broadcast mode.

### Network Topologies

#### Cable Replacement Configuration for Point to Point Networks

Figure 2. Simple point to point network



In this simple cable replacement application, the radio system knows all data originating at one end must be transmitted to the other end. This allows the radio system to automatically correct for transmission problems and it also provides the greatest throughput. This is the fastest configuration.

- Master configuration route to slave: DIP switches 2 OFF, 3 OFF, 4 ON
- Slave configuration route to master: DIP switches 2 OFF, 3 OFF, 4 OFF

Figure 3. Point to point network with repeater

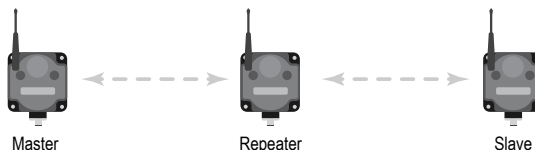

In this simple cable replacement application with repeater, the radio system still knows all data originating at one end must be transmitted to the other end. In this application, there are no serial devices connected to the repeater(s). The system still corrects for transmission problems, but it takes time to repeat the message. The network delay is double that of a system with no repeater.

- Master configuration route to slave: DIP switches 2 OFF, 3 OFF, 4, ON
- Repeater configuration: DIP switches 2 ON, 3 ON, 4 OFF
- Slave configuration route to master: DIP switches 2 OFF, 3 OFF, 4 OFF

### Broadcast Mode Configuration

Figure 4. Star network

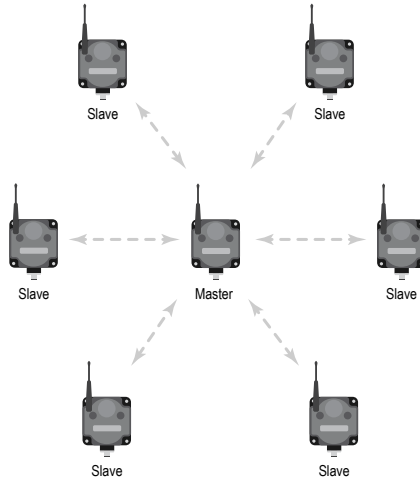

In this more complex star topology, the master radio at the center of the network can communicate to many slave radios. A common example would be a PLC at the center communicating with many remote I/O systems. The star topology is slower than a point-to-point network, but faster than a tree network.

- Master configuration to broadcast to all devices: DIP switches 2 ON, 3 OFF, 4 ON
- Slave configuration to route to master: DIP switches 2 OFF, 3 OFF, 4 OFF

Figure 5. Tree network

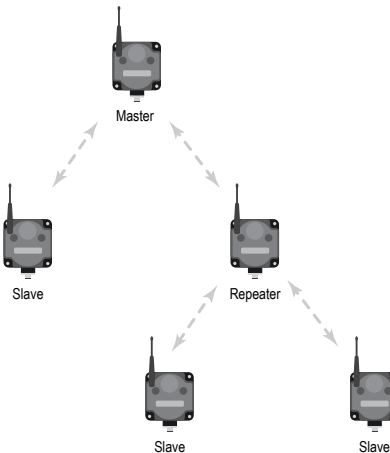

A tree network using MultiHop radios is the most powerful wireless system possible; many repeaters and slaves can be combined to cover vast areas and get around hills or buildings. In the other networks, the wireless "hops" are minimized. In this system you can "hop" as much as you need to, but the trade-off is speed. This is the slowest of the network layouts.

- Master configuration to broadcast to all devices: DIP switches 2 ON, 3 OFF, 4 ON
- Repeater configuration to broadcast to all devices: DIP switches 2 ON, 3 ON, 4 OFF
- Slave configuration to broadcast to all devices: DIP switches 2 ON, 3 OFF, 4 OFF



**Important:** Star and tree topologies use a Broadcast radio technique. Broadcasting allows for many radios and large complex systems but also introduces a small chance that a data packet can be lost. These networks topologies require the control system to automatically resend missing data packets. Most control protocols (like Modbus) will work fine. Other serial stream based protocols may not be as tolerant and should only be used with point to point topologies.

### Apply Power

The R70SR Serial Data Radio is fitted with a 5-pin M12 connector for fast installations. Use straight splitter cordsets to connect multiple devices and power to the R70SR Serial Radio. For a list of splitter and cordset options, see [Accessories](#) on page 6.

5-pin M12 Male Connector	Pin	Wire Color	Wiring Description
	1	Brown (bn)	10 to 30 V DC
	2	White (wh)	RS-485 / D1 / B / +
	3	Blue (bu)	DC common (GND)
	4	Black (bk)	RS-485 / D0 / A / -
	5	Gray (gy)	No connection

## Bind the R70SR Serial Data Radio to Form a Network

To create your network, bind the R70SR to the designated master radio.

Binding the serial data radios ensures all radios within a network communicate only with the other radios within the same network. The serial data radio master automatically generates a unique binding code when the radio master enters binding mode. This code is transmitted to all radios within range that are also in binding mode. After a repeater/slave is bound, the repeater/slave radio accepts data only from the master to which it is bound. The binding code defines the network, and all radios within a network must use the same binding code.

1. Apply power to all radios and place the R70SR radio at least two meters away from the master radio.
2. Remove the cover. See [Open the Cover](#) on page 2.
3. On the master radio: Triple-click the binding button to put the master radio into binding mode. Both LEDs flash red.
4. On the R70SR: Triple-click the binding button to put the R70SR into binding mode. The radio enters binding mode and searches for any master radio in binding mode. While searching for the master radio, the two red LEDs flash alternately. When the radio finds the master radio and is bound, both red LEDs are solid for four seconds, then both red LEDs flash simultaneously four times.
5. Re-install the R70SR's cover.
6. Repeat steps 3 through 5 for as many radios as are needed for your network.
7. On the master radio: After all radios are bound, double-click the binding button to exit binding mode on the master. The network begins to form after the master data radio exits binding mode.
8. On the master radio: Re-install the cover to protect the button and radio board.

### Child Radios Synchronize to the Parent Radios

The synchronization process enables a Sure Cross radio to join a wireless network formed by a master radio. A simple point-to-point network with one master radio and one slave radio synchronizes quickly after power up; larger MultiHop networks may take a few minutes to synchronize. First, all radios within range of the master data radio wirelessly synchronize to the master radio. These radios may be slave radios or repeater radios.

After repeater radios are synchronized to the master radio, any radios that are not in sync with the master but can "hear" the repeater radio will synchronize to the repeater radios. Each repeater "family" that forms a wireless network path creates another layer of synchronization process. The table below details the process of synchronization with a parent. When testing the devices before installation, verify the radio devices are at least two meters apart or the communications may fail.

## Master LED Behavior

All bound serial radios set to operate as masters follow this LED behavior after powering up.

Process Steps	Response	LED 1	LED 2
1	Apply power to the master radio	-	Solid amber
2	The master radio enters RUN mode.	Flashes green	-
	Serial data packets begin transmitting between the master and its children radios.	-	Flashes amber
	In binding mode	Flashes red	Flashes red

## Slave and Repeater LED Behavior

All bound radios set to slave or repeater modes follow this LED behavior after powering up.

Process Steps	Response	LED 1	LED 2
1	Apply power to the radio	-	Solid amber (briefly)
2	The slave/repeater searches for a parent device.	Flashes red	-
3	A parent device is detected. The slave/repeater searches for other parent radios within range.	Solid red	-
4	The slave/repeater selects a suitable parent.	-	Solid amber
5	The slave/repeater attempts to synchronize to the selected parent.	-	Solid red
6	The slave/repeater is synchronized to the parent.	Flashes green	-
7	The slave/repeater enters RUN mode.	Solid green, then flashes green	-
	Serial data packets begin transmitting between the slave/repeater and its parent radio.	-	Flashes amber
	In binding mode	Flashes red	Flashes red

## Installing Your Sure Cross® Radios

Please refer to one of these instruction manuals to install your wireless network components.

- DX80 Performance Wireless I/O Network Instruction Manual: [132607](#)
- MultiHop Data Radio Instruction Manual: [151317](#)

## Specifications

### Radio Range

900 MHz, 1 Watt: Up to 3.2 km (2 miles) with line of sight (internal antenna)  
2.4 GHz, 65 mW: Up to 1000 m (3280 ft) with line of sight (internal antenna)

### Antenna Minimum Separation Distance

900 MHz, 150 mW and 250 mW: 2 m (6 ft)  
900 MHz, 1 Watt: 4.57 m (15 ft)  
2.4 GHz, 65 mW: 0.3 m (1 ft)

### Radio Transmit Power

900 MHz, 1 Watt: 30 dBm (1 W) conducted (up to 36 dBm EIRP)  
2.4 GHz, 65 mW: 18 dBm (65 mW) conducted, less than or equal to 20 dBm (100 mW) EIRP

### Radio Packet Size (SRM-H and HL)

1500 bytes, maximum

### Communication Hardware

Interface: 2-wire half-duplex RS-485  
Baud rates: 9600, 19.2k (default)  
Data format: 8 data bits, 1 stop bit, no parity (default)

### Supply Voltage

10 V DC to 30 V DC (Outside the USA: 12 V DC to 24 V DC,  $\pm 10\%$ )<sup>‡</sup>

### Average Current for 900 MHz Radios (1500 byte packets at 50 ms intervals)

Master Mode: 0.12 A at 12 V; 0.06 A at 24 V  
Slave Mode: 0.03 A at 12 V; 0.017 A at 24 V

### Average Current for 2.4 GHz Radios (1500 byte packets at 50 ms intervals)

Master Mode: 0.035 A at 12 V; 0.02 A at 24 V  
Slave Mode: 0.022 A at 12 V; 0.014 A at 24 V

### Interface

Two bi-color LED indicators  
One button (under the small round cover)

### Construction

Base: Black polycarbonate  
Cover: Translucent gray polycarbonate

### Shock and Vibration

All models meet IEC 60068-2-6 and IEC 60068-2-27 testing criteria  
Shock: 30G 11 ms duration, half sine wave per IEC 60068-2-27  
Vibration: 10 Hz to 55 Hz, 0.5 mm peak-to-peak amplitude per IEC 60068-2-6

### 900 MHz Compliance

Radio module is indicated by the product label marking  
Contains FCC ID: UE3RM7023: FCC Part 15, Subpart C, 15.247  
Contains IC: 7044A-RM7023

### 2.4 GHz Compliance (SX243 Radio Module)

Radio module is indicated by the product label marking  
Contains FCC ID: UE3SX243: FCC Part 15, Subpart C, 15.247  
Radio Equipment Directive (RED) 2014/53/EU  
Contains IC: 7044A-SX243  
ANATEL: 03737-22-04042 Este equipamento não tem direito à proteção contra interferência prejudicial e não pode causar interferência em sistemas devidamente autorizados. Para maiores informações, consulte o site da ANATEL [www.gov.br/anatel/pt-br/](http://www.gov.br/anatel/pt-br/)



### Spread Spectrum Technology

FHSS (Frequency Hopping Spread Spectrum)

### Radio Data Transfer Rate

900 MHz: 300 kbps  
2.4 GHz: 250 kbps

### Operating Conditions

-40 °C to +85 °C (-40 °F to +185 °F)  
95% maximum relative humidity (non-condensing)  
Radiated Immunity: 10 V/m (EN 61000-4-3)  
Operating the devices at the maximum operating conditions for extended periods can shorten the life of the device.

### Environmental Ratings

IP65  
For installation and waterproofing instructions, go to [www.bannerengineering.com](http://www.bannerengineering.com) and search for the complete instruction manual

### Certifications



**Banner Engineering Europe** Park Lane, Culliganlaan 2F bus 3, 1831 Diegem, BELGIUM

(CE/UKCA approval only applies to 2.4 GHz models)

**Turck Banner LTD** Blenheim House, Blenheim Court, Wickford, Essex SS11 8YT, Great Britain

<sup>‡</sup> For European applications, power this device from a Limited Power Source as defined in EN 60950-1.

## Dimensions

All measurements are listed in millimeters, unless noted otherwise.

Figure 6. Dimensions for the R70SR

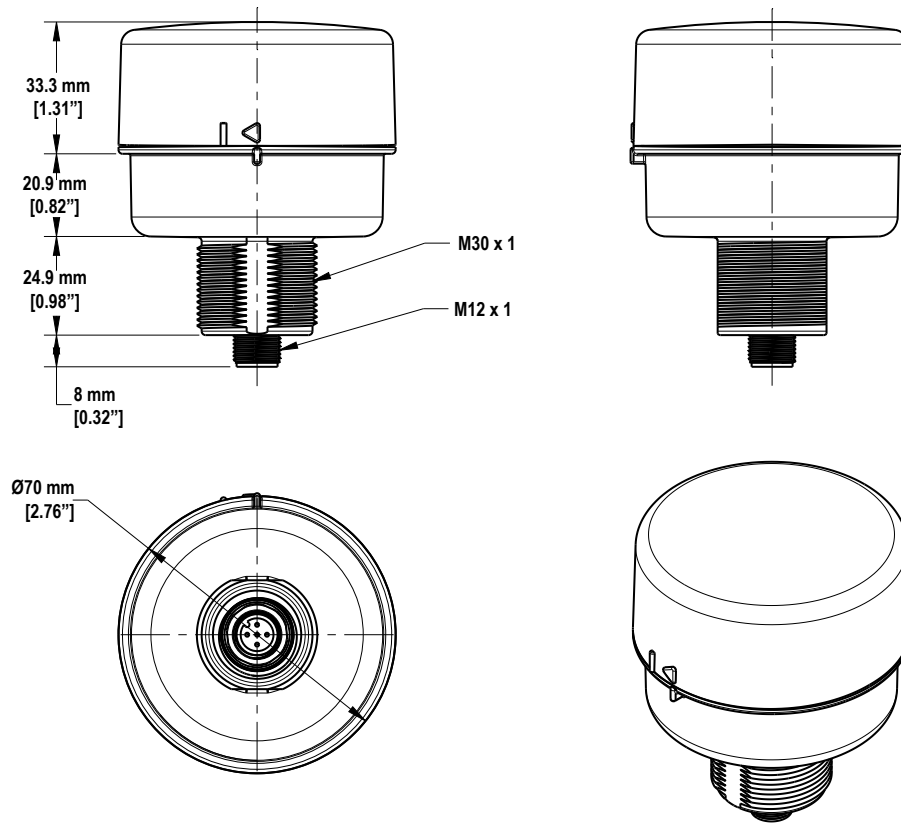

## Accessories

5-Pin Threaded M12 Cordsets—Double Ended					
Model	Length	Style	Dimensions	Pinout (Male)	Pinout (Female)
MQDEC-501SS	0.31 m (1.02 ft)	Male Straight/ Female Straight			
MQDEC-503SS	0.91 m (2.99 ft)				
MQDEC-506SS	1.83 m (6 ft)				
MQDEC-512SS	3.66 m (12 ft)				
MQDEC-515SS	5 m (16.4 ft)				
MQDEC-530SS	9 m (29.5 ft)				
MQDEC-550SS	15 m (49.2 ft)				
<p>1 = Brown 2 = White 3 = Blue</p> <p>4 = Black 5 = Gray</p>					
5-Pin Threaded M12 Splitter Cordset with Flat Junction—Double Ended					
Model	Trunk (Male)	Branches (Female)	Pinout (Male)	Pinout (Female)	
CSB4-M1251M1250	0.3 m (0.98 ft)	Four (no cable)			

5-Pin Threaded M12 Splitter Cordset with Flat Junction—Double Ended				
Model	Trunk (Male)	Branches (Female)	Pinout (Male)	Pinout (Female)
			1 = Brown 2 = White 3 = Blue	4 = Black 5 = Gray

5-Pin Threaded M12 Splitter Tee				
Model	Description		Pinout (Male)	Pinout (Female)
CSB-M1250M1250-T	Female trunk, 1 female branch, 1 male branch		 1 = Brown 2 = White 3 = Blue	 4 = Black 5 = Green/Yellow

**Brackets and Covers**

**LMB30LP**

- Low profile
- 30 mm mounting hole
- 300 series stainless steel

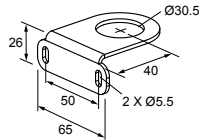

**WC-R70 Washdown Cover**

- FDA-grade silicone
- Fits R70 data radios
- IP67 and IP69K rated

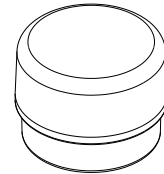

**Warnings**

**Install and properly ground a qualified surge suppressor when installing a remote antenna system.** Remote antenna configurations installed without surge suppressors invalidate the manufacturer’s warranty. Keep the ground wire as short as possible and make all ground connections to a single-point ground system to ensure no ground loops are created. No surge suppressor can absorb all lightning strikes; do not touch the Sure Cross® device or any equipment connected to the Sure Cross device during a thunderstorm.

**Exporting Sure Cross® Radios.** It is our intent to fully comply with all national and regional regulations regarding radio frequency emissions. **Customers who want to re-export this product to a country other than that to which it was sold must ensure the device is approved in the destination country.** The Sure Cross wireless products were certified for use in these countries using the antenna that ships with the product. When using other antennas, verify you are not exceeding the transmit power levels allowed by local governing agencies. This device has been designed to operate with the antennas listed on Banner Engineering’s website and having a maximum gain of 9 dBm. Antennas not included in this list or having a gain greater than 9 dBm are strictly prohibited for use with this device. The required antenna impedance is 50 ohms. To reduce potential radio interference to other users, the antenna type and its gain should be so chosen such that the equivalent isotropically radiated power (EIRP) is not more than that permitted for successful communication. Consult with Banner Engineering Corp. if the destination country is not on this list.



**Important:** Please download the complete Sure Cross® R70SR Serial Data Radio technical documentation, available in multiple languages, from [www.bannerengineering.com](http://www.bannerengineering.com) for details on the proper use, applications, Warnings, and installation instructions of this device.



**Important:** Por favor descargue desde [www.bannerengineering.com](http://www.bannerengineering.com) toda la documentación técnica de los Sure Cross® R70SR Serial Data Radio, disponibles en múltiples idiomas, para detalles del uso adecuado, aplicaciones, advertencias, y las instrucciones de instalación de estos dispositivos.



**Important:** Veuillez télécharger la documentation technique complète des Sure Cross® R70SR Serial Data Radio sur notre site [www.bannerengineering.com](http://www.bannerengineering.com) pour les détails sur leur utilisation correcte, les applications, les notes de sécurité et les instructions de montage.



**WARNING:**

- **Do not use this device for personnel protection**
- Using this device for personnel protection could result in serious injury or death.
- This device does not include the self-checking redundant circuitry necessary to allow its use in personnel safety applications. A device failure or malfunction can cause either an energized (on) or de-energized (off) output condition.

**Important:**

- **Never operate a 1 Watt radio without connecting an antenna**
- Operating 1 Watt radios without an antenna connected will damage the radio circuitry.
- To avoid damaging the radio circuitry, never apply power to a Sure Cross® Performance or Sure Cross MultiHop (1 Watt) radio without an antenna connected.

**Important:**

- **Electrostatic discharge (ESD) sensitive device**
- ESD can damage the device. Damage from inappropriate handling is not covered by warranty.
- Use proper handling procedures to prevent ESD damage. Proper handling procedures include leaving devices in their anti-static packaging until ready for use; wearing anti-static wrist straps; and assembling units on a grounded, static-dissipative surface.

## Banner Engineering Corp Limited Warranty

Banner Engineering Corp. warrants its products to be free from defects in material and workmanship for one year following the date of shipment. Banner Engineering Corp. will repair or replace, free of charge, any product of its manufacture which, at the time it is returned to the factory, is found to have been defective during the warranty period. This warranty does not cover damage or liability for misuse, abuse, or the improper application or installation of the Banner product.

**THIS LIMITED WARRANTY IS EXCLUSIVE AND IN LIEU OF ALL OTHER WARRANTIES WHETHER EXPRESS OR IMPLIED (INCLUDING, WITHOUT LIMITATION, ANY WARRANTY OF MERCHANTABILITY OR FITNESS FOR A PARTICULAR PURPOSE), AND WHETHER ARISING UNDER COURSE OF PERFORMANCE, COURSE OF DEALING OR TRADE USAGE.**

This Warranty is exclusive and limited to repair or, at the discretion of Banner Engineering Corp., replacement. **IN NO EVENT SHALL BANNER ENGINEERING CORP. BE LIABLE TO BUYER OR ANY OTHER PERSON OR ENTITY FOR ANY EXTRA COSTS, EXPENSES, LOSSES, LOSS OF PROFITS, OR ANY INCIDENTAL, CONSEQUENTIAL OR SPECIAL DAMAGES RESULTING FROM ANY PRODUCT DEFECT OR FROM THE USE OR INABILITY TO USE THE PRODUCT, WHETHER ARISING IN CONTRACT OR WARRANTY, STATUTE, TORT, STRICT LIABILITY, NEGLIGENCE, OR OTHERWISE.**

Banner Engineering Corp. reserves the right to change, modify or improve the design of the product without assuming any obligations or liabilities relating to any product previously manufactured by Banner Engineering Corp. Any misuse, abuse, or improper application or installation of this product or use of the product for personal protection applications when the product is identified as not intended for such purposes will void the product warranty. Any modifications to this product without prior express approval by Banner Engineering Corp will void the product warranties. All specifications published in this document are subject to change; Banner reserves the right to modify product specifications or update documentation at any time. Specifications and product information in English supersede that which is provided in any other language. For the most recent version of any documentation, refer to: [www.bannerengineering.com](http://www.bannerengineering.com).

For patent information, see [www.bannerengineering.com/patents](http://www.bannerengineering.com/patents).

## FCC Part 15 Class A

This equipment has been tested and found to comply with the limits for a Class A digital device, pursuant to part 15 of the FCC Rules. These limits are designed to provide reasonable protection against harmful interference when the equipment is operated in a commercial environment. This equipment generates, uses, and can radiate radio frequency energy and, if not installed and used in accordance with the instruction manual, may cause harmful interference to radio communications. Operation of this equipment in a residential area is likely to cause harmful interference in which case the user will be required to correct the interference at his own expense.

## Industry Canada

This device contains licence-exempt transmitters(s)/receiver(s) that comply with Innovation, Science and Economic Development Canada's licence-exempt RSS(s). Operation is subject to the following two conditions:

1. This device may not cause interference.
2. This device must accept any interference, including interference that may cause undesired operation of the device.

Cet appareil contient des émetteurs/récepteurs exemptés de licence conformes à la norme Innovation, Sciences, et Développement économique Canada. L'exploitation est autorisée aux deux conditions suivantes:

1. L'appareil ne doit pas produire de brouillage.
2. L'utilisateur de l'appareil doit accepter tout brouillage radioélectrique subi, même si le brouillage est susceptible d'en compromettre le fonctionnement.