

Specification

Part No.	:	GSA.8842.A.105111
Product Name	:	Wideband 5G/4G, ISM and Wi-Fi Adhesive Mount I-Bar Antenna with 1M CFD-200 SMA(M)
Features	:	5G/4G/3G / GPS / Wi-Fi 176.5mm * 59.2mm *13.6mm 617MHz to 6000MHz Cable: 1M CFD-200 Connector: SMA(M)

RoHS & REACH Compliant



1. Introduction

The GSA.8842 Wideband Dipole Antenna has been designed to cover all 5G/4G, ISM and Wi-Fi working frequencies in the 617-6000 MHz spectrum. It has the highest wide-band efficiency in its range of any terminal antenna on the market today and exhibits stable, omni-directional radiation patterns across all bands. It is an ideal solution for any device requiring high, reliable performance. When appropriately integrated, it can maximize the likelihood of meeting type approval or carrier certification requirements from an efficiency standpoint.

The GSA.8842 has been primarily designed for use with 5G/4G modules and devices that require the highest possible efficiency and peak gain to deliver best-in-class throughput on all major cellular (2G/3G/4G/5G) bands worldwide, vital for applications such as high speed video and real-time streaming, or high capacity MIMO networks on public transportation. It also provides good efficiency on both 2.4 and 5.8GHz Wi-Fi bands and is backwards-compatible with 2G and 3G cellular applications such as GSM, LTE, UMTS, Wi-Fi. This antenna also makes an excellent reference antenna for test purposes.

GSA.8842 has a low-profile, compact form factor and is easily mounted via high quality, first tier automotive approved 3M adhesive foam. The standard cable assembly includes 1 meter coaxial cable and SMA (M) connector. Cable and connector are customizable. Contact your regional Taoglas sales office for support.

2. Specification

Electrical									
Frequency (MHz)	617~698	698~960	1565~1612	1710~1990	1920~2170	2400~2500	2500~2700	4900~5850	
Efficiency (%)									
In free space	0.3M	68.69	70.38	29.13	74.62	73.03	70.51	72.54	61.16
	1M	64.49	66.77	26.57	68.07	67.08	64.37	66.17	52.55
	2M	60.19	61.85	24.09	60.23	58.78	56.06	57.08	42.55
	3M	56.17	57.31	21.60	53.42	51.98	48.83	49.43	34.48
	5M	48.92	49.16	17.19	42.02	40.53	37.04	37.08	22.61
On the 2mm ABS Base	0.3M	69.05	72.92	56.73	73.06	70.03	73.19	72.43	62.01
	1M	64.82	69.20	51.73	66.62	64.31	66.75	66.04	53.29
	2M	60.49	64.09	46.98	58.96	56.35	58.13	56.97	43.15
	3M	56.46	59.38	42.05	52.30	49.83	50.63	49.34	34.98
	5M	49.17	50.93	33.48	41.14	38.85	38.41	37.01	22.94
On the Glass Base	0.3M	65.08	72.21	72.81	70.19	71.02	79.11	65.80	51.55
	1M	61.11	68.55	66.40	64.00	65.26	72.16	59.98	44.27
	2M	57.03	63.47	60.34	56.64	57.17	62.85	51.81	35.85
	3M	53.22	58.79	53.97	50.26	50.56	54.74	44.87	29.05
	5M	46.35	50.42	43.01	39.52	39.40	41.52	33.65	19.05
Average Gain(dB)									
In free space	0.3M	-1.63	-1.53	-5.36	-1.27	-1.37	-1.52	-1.39	-2.14
	1M	-1.90	-1.75	-5.76	-1.67	-1.73	-1.91	-1.79	-2.79
	2M	-2.20	-2.09	-6.18	-2.20	-2.31	-2.51	-2.44	-3.71
	3M	-2.50	-2.42	-6.66	-2.72	-2.84	-3.11	-3.06	-4.62
	5M	-3.10	-3.08	-7.65	-3.77	-3.92	-4.31	-4.31	-6.46
On the 2mm ABS Base	0.3M	-1.61	-1.37	-2.46	-1.36	-1.55	-1.36	-1.40	-2.08
	1M	-1.88	-1.60	-2.86	-1.76	-1.92	-1.76	-1.80	-2.73
	2M	-2.18	-1.93	-3.28	-2.29	-2.49	-2.36	-2.44	-3.65
	3M	-2.48	-2.26	-3.76	-2.82	-3.02	-2.96	-3.07	-4.56
	5M	-3.08	-2.93	-4.75	-3.86	-4.11	-4.16	-4.32	-6.39
On the Glass Base	0.3M	-1.87	-1.41	-1.38	-1.54	-1.49	-1.02	-1.82	-2.88
	1M	-2.14	-1.64	-1.78	-1.94	-1.85	-1.42	-2.22	-3.54
	2M	-2.44	-1.97	-2.19	-2.47	-2.43	-2.02	-2.86	-4.46
	3M	-2.74	-2.31	-2.68	-2.99	-2.96	-2.62	-3.48	-5.37
	5M	-3.34	-2.97	-3.66	-4.03	-4.04	-3.82	-4.73	-7.20

		Peak Gain(dBi)							
Frequency (MHz)		617~698	698~960	1565~1612	1710~1990	1920~2170	2400~2500	2500~2700	4900~5850
In free space	0.3M	2.63	2.75	-0.14	3.65	3.65	4.20	4.20	4.17
	1M	2.33	2.55	-0.54	3.25	3.25	3.80	3.80	3.47
	2M	2.03	2.15	-1.04	2.71	2.71	3.20	3.20	2.57
	3M	1.73	1.85	-1.44	2.15	2.15	2.60	2.60	1.57
	5M	1.43	1.55	-1.84	1.65	1.65	2.00	2.00	0.57
On the 2mm ABS Base	0.3M	2.34	2.71	1.42	3.65	3.58	3.73	4.36	4.50
	1M	2.04	2.51	1.02	3.25	3.18	3.33	3.96	3.80
	2M	1.74	2.11	0.52	2.75	2.68	2.73	3.26	2.90
	3M	1.44	1.81	0.12	2.15	2.08	2.13	2.66	1.93
	5M	1.14	1.51	-0.28	1.55	1.48	1.53	2.06	1.03
On the Glass Base	0.3M	2.02	2.89	3.63	4.77	4.60	5.28	5.28	4.32
	1M	1.72	2.69	3.23	4.37	4.20	4.88	4.88	3.62
	2M	1.42	2.29	2.73	3.87	3.70	4.28	4.28	2.62
	3M	1.12	1.99	2.33	3.37	3.10	3.68	3.68	1.72
	5M	0.82	1.69	1.93	2.87	2.50	3.08	3.08	0.82
Impedance	50Ω								
Polarization	Linear								
VSWR	< 3								
Radiation Pattern	Omni								
Input Power	5 W								
Mechanical									
Antenna Dimensions	176.5mm * 59.2mm *13.6mm								
Casing	ABS								
Coaxial Cable	CFD-200								
Cable Length	1 Meter Standard, Fully Customizable								
Connector	SMA Male Standard, Fully Customizable								
Adhesive	3M9448+CR4305 Double Sided Adhesive								
Weight	127g								
Environmental									
Operation Temperature Range	-40°C to 85°C								
Storage Temperature Range	-40°C to 85°C								
Humidity	Non-condensing 65°C 95% RH								

3. Antenna Characteristics

3.1 Test Setup



a) In free space



b) On 2mm ABS Base

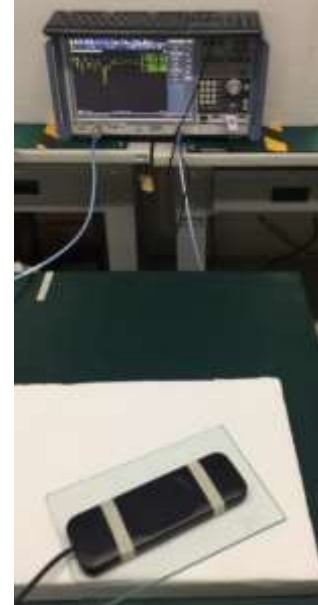

c) On the Glass Base

3.2 Return Loss

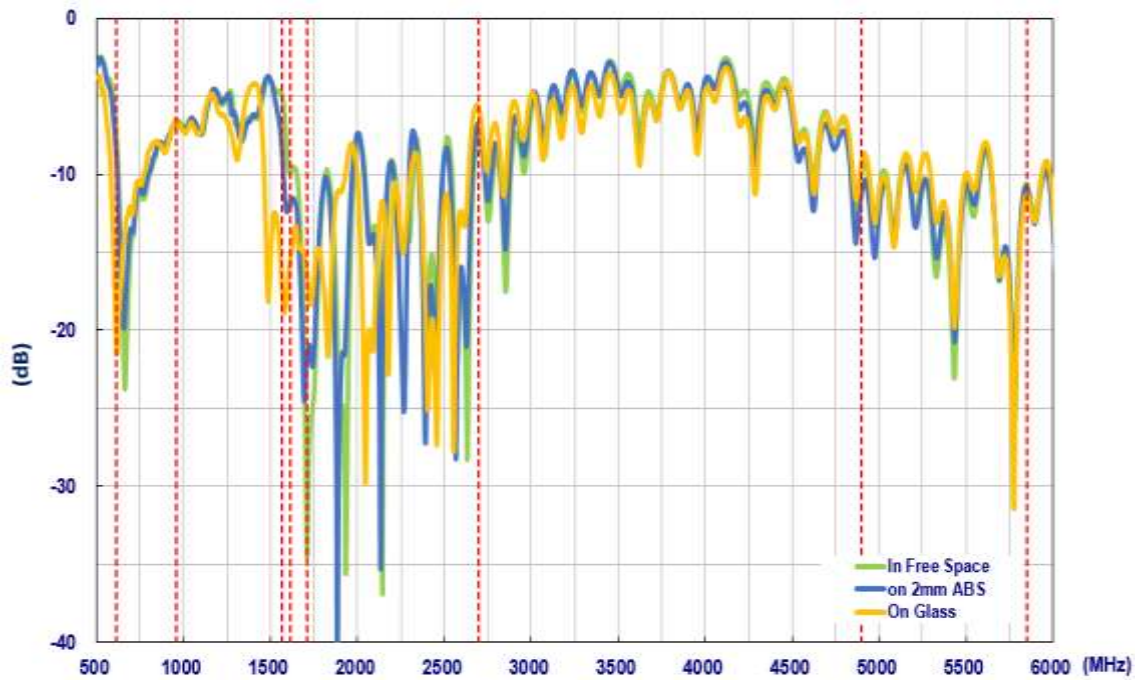

Figure 1. Return loss of GSA.8842 with 1 meter cable length

3.3 Efficiency

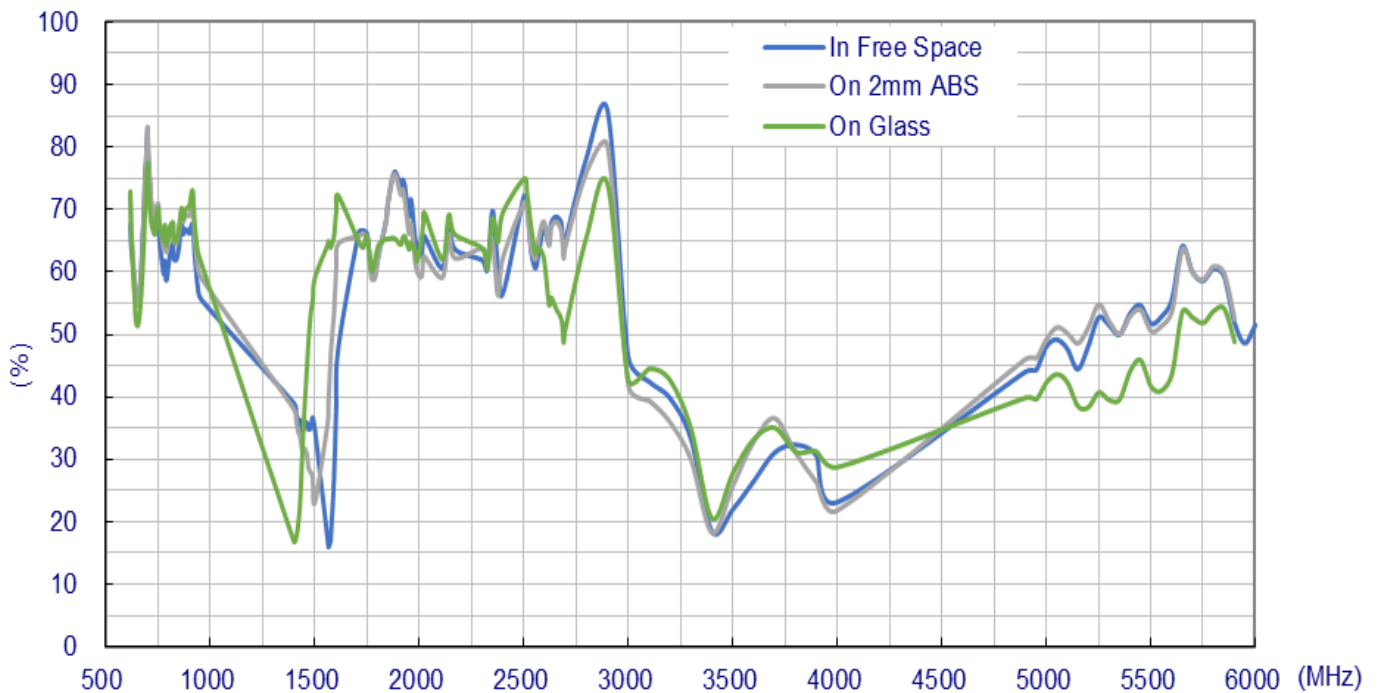

Figure 2. Efficiency of GSA.8842 with 1 meter cable length

3.4 Peak Gain

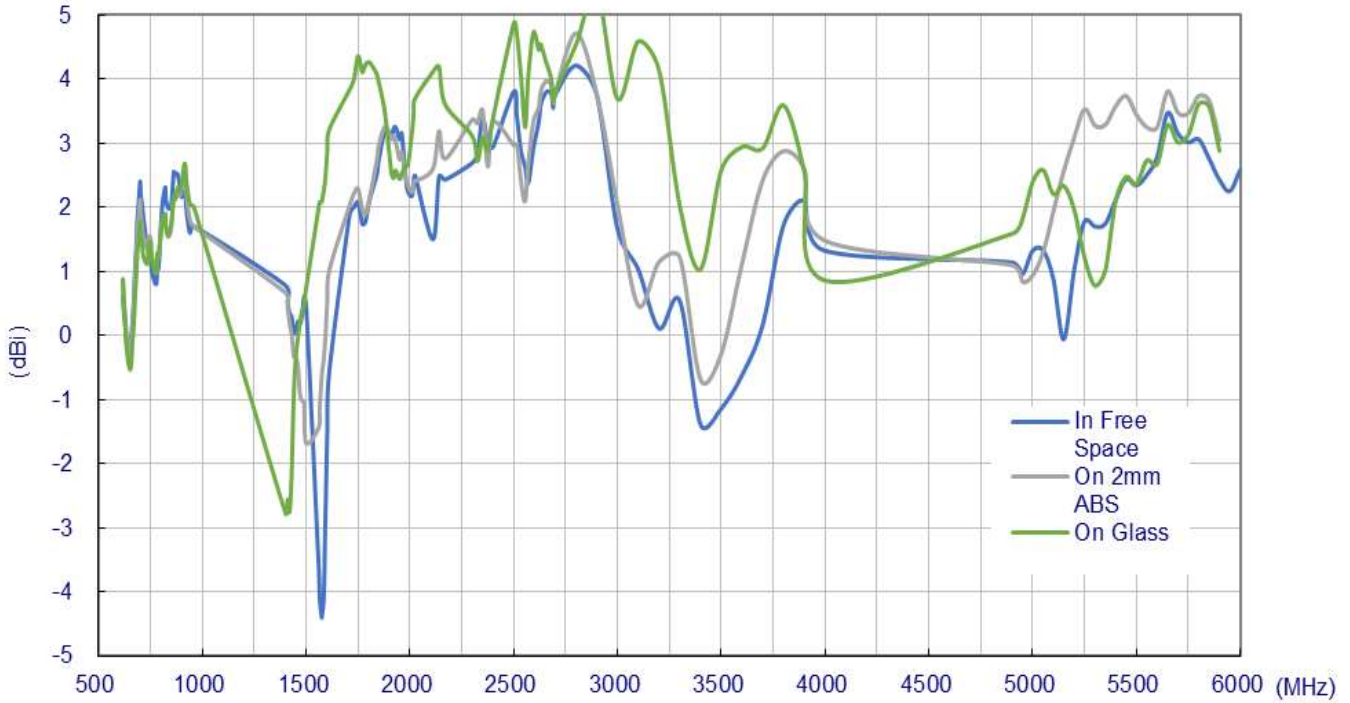

Figure 3. Peak gain of GSA.8842 with 1 meter cable length

3.5 Average Gain

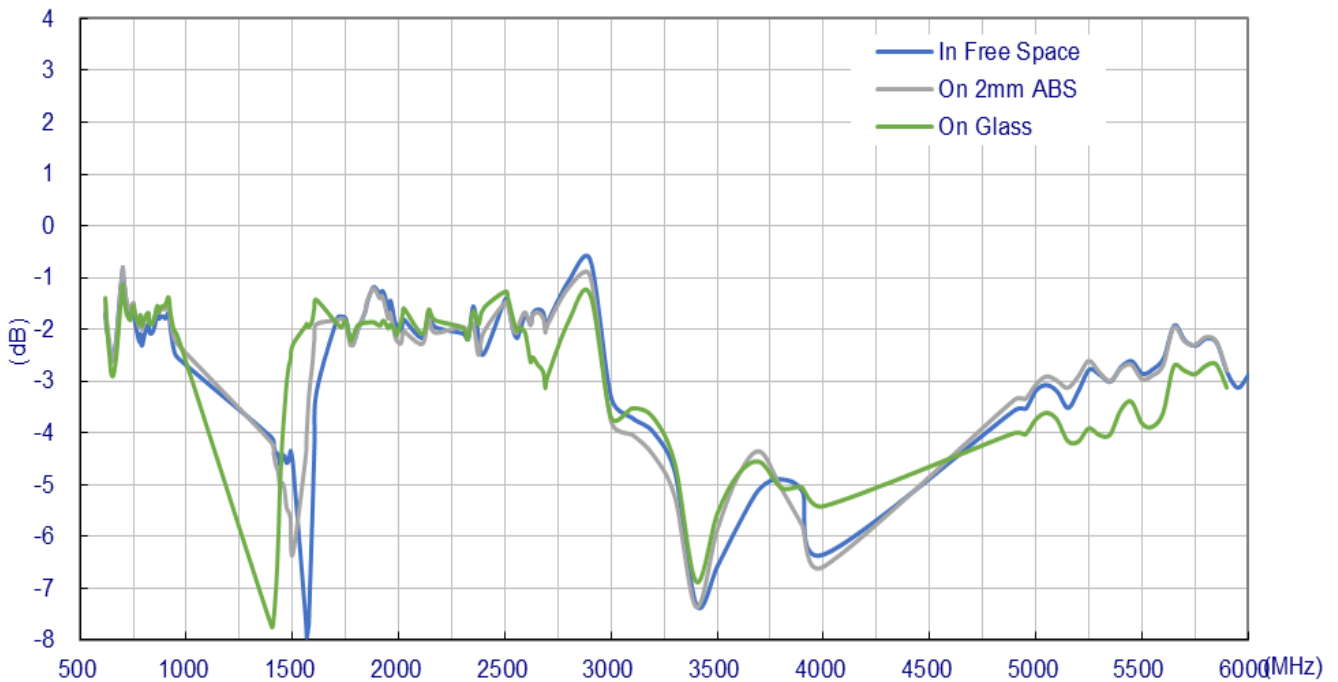

Figure 4. Average gain of GSA.8842 with 1 meter cable length

4. Antenna Radiation Patterns

The antenna radiation patterns were measured in an anechoic chamber. The measurement setup is shown below.



a) In free space



2) On 2mm ABS base



3) On the glass base

4.1 Antenna radiation patterns

XY plane (Antenna with 1 meter cable length in free space)

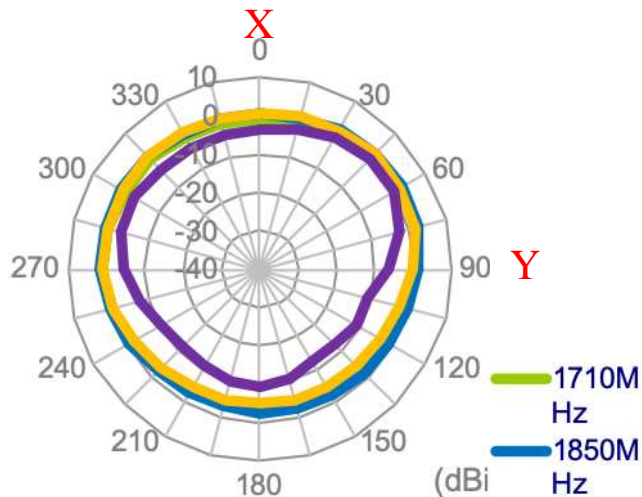
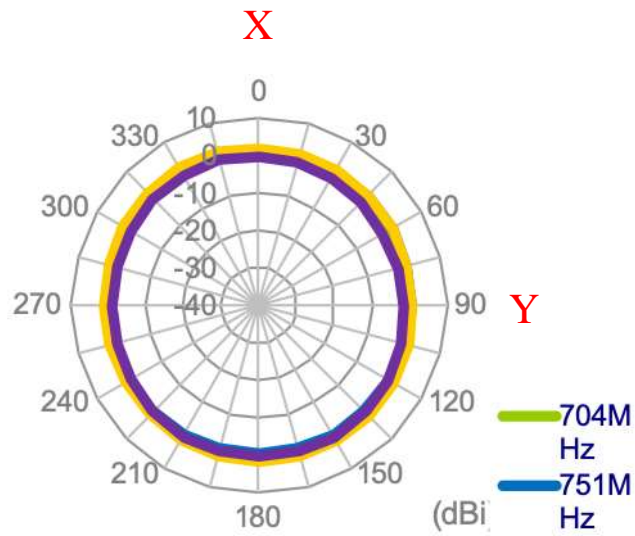
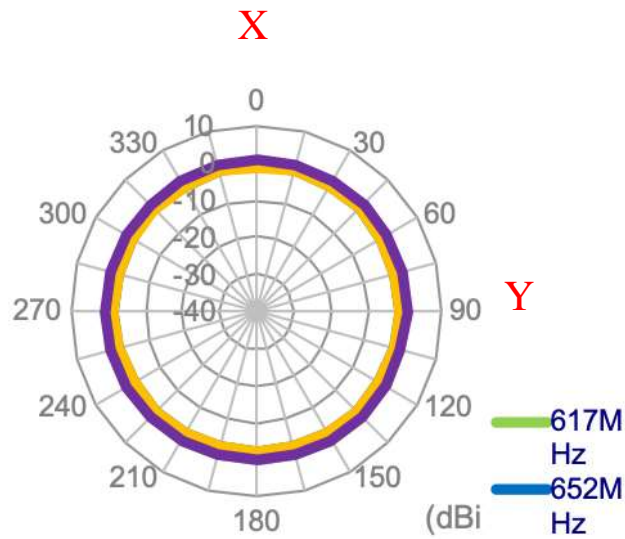

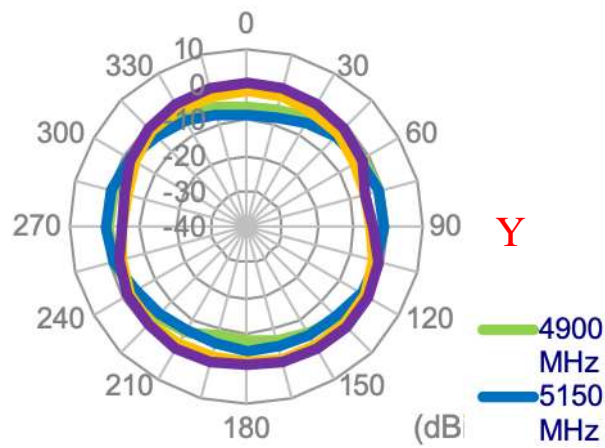
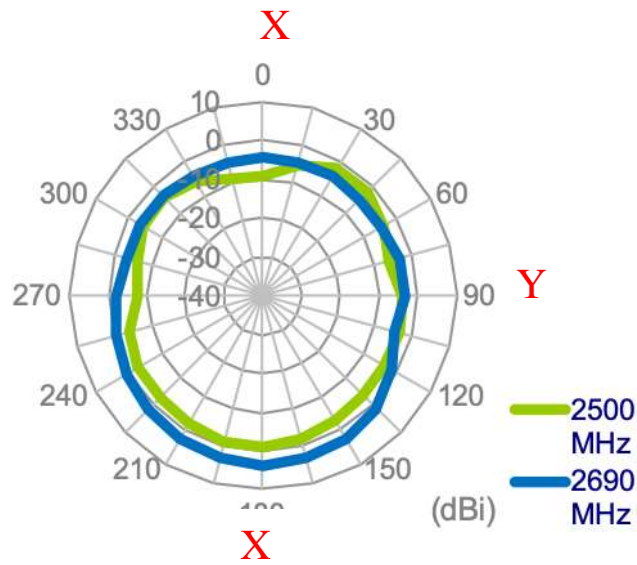

4.2 XZ plane (Antenna with 1 meter cable length in free space)

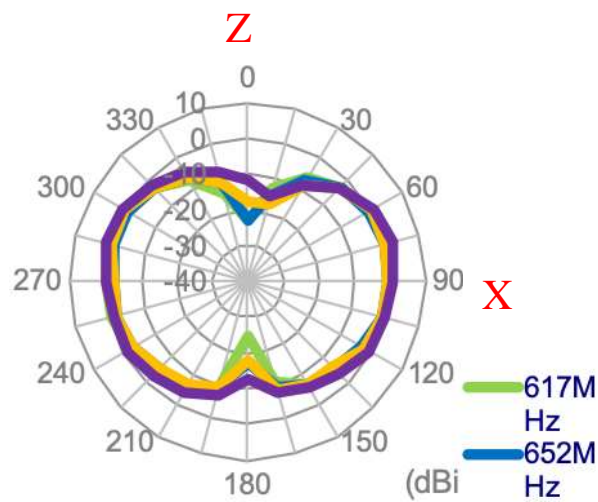

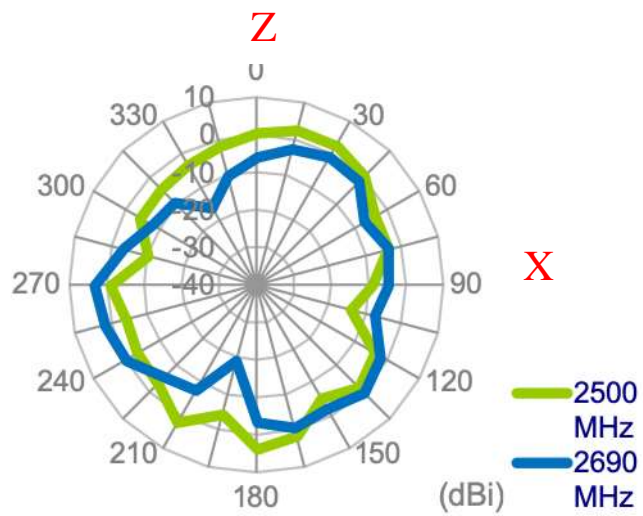
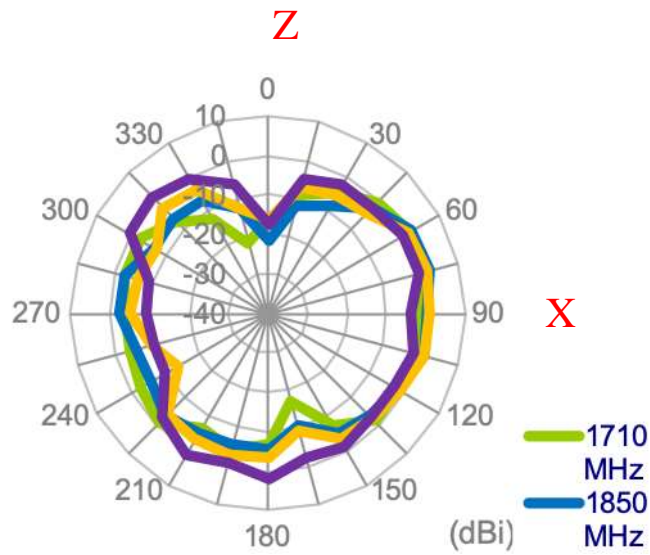
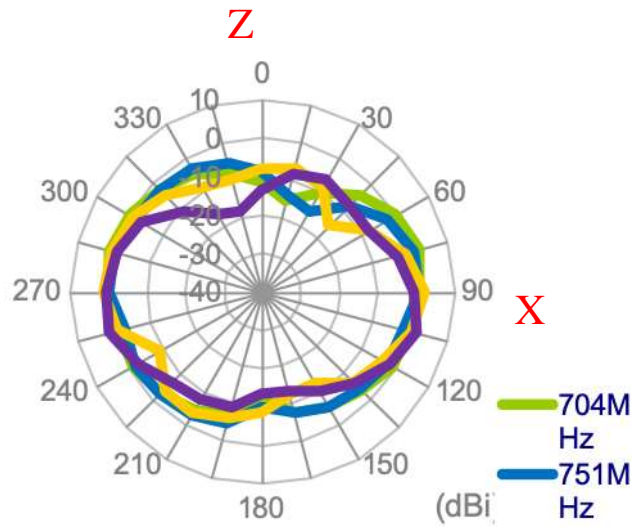

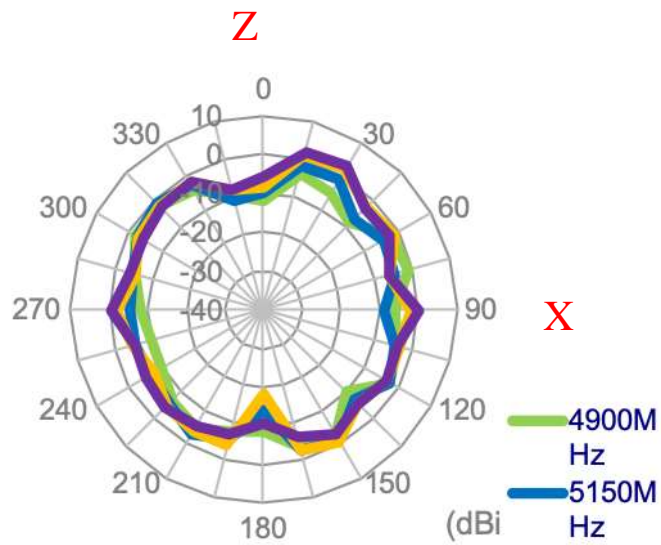

4.3 YZ plane (Antenna with 1 meter cable length in free space)

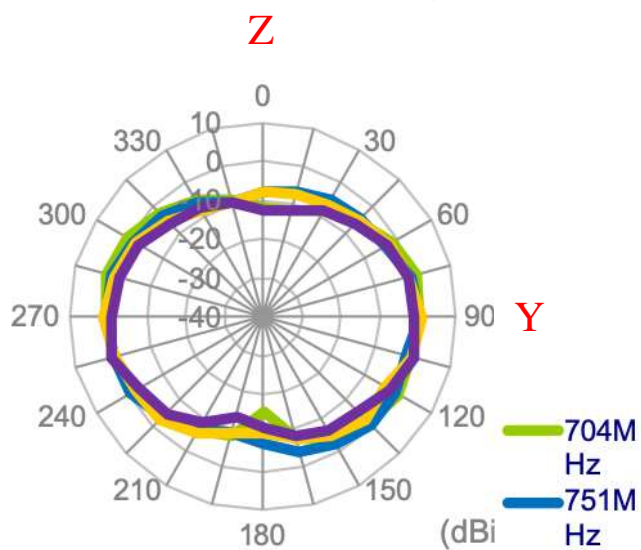
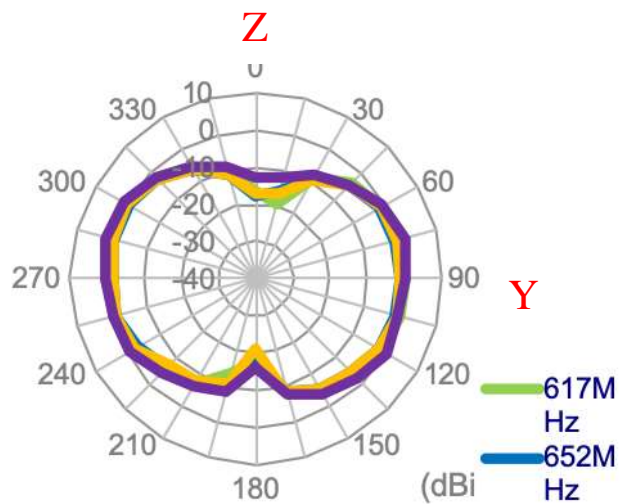

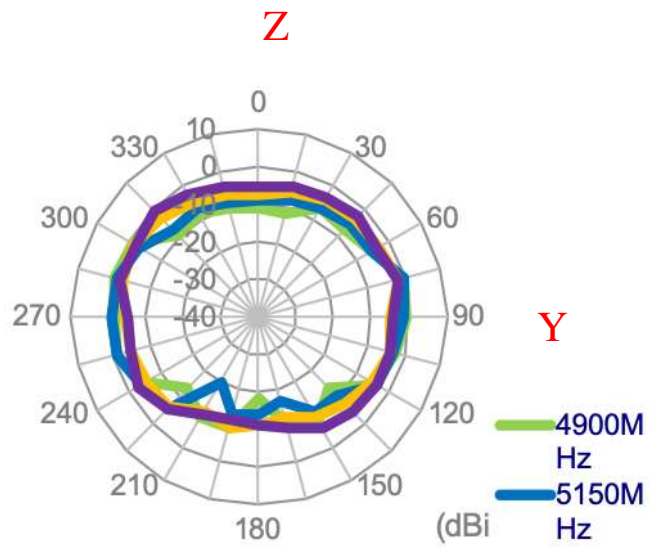
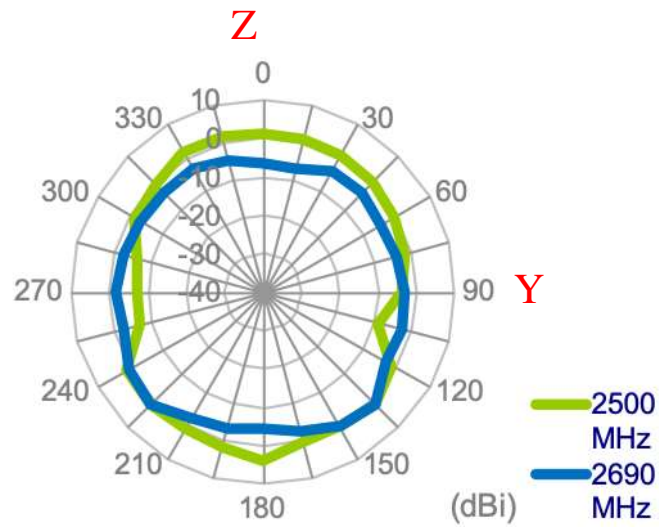
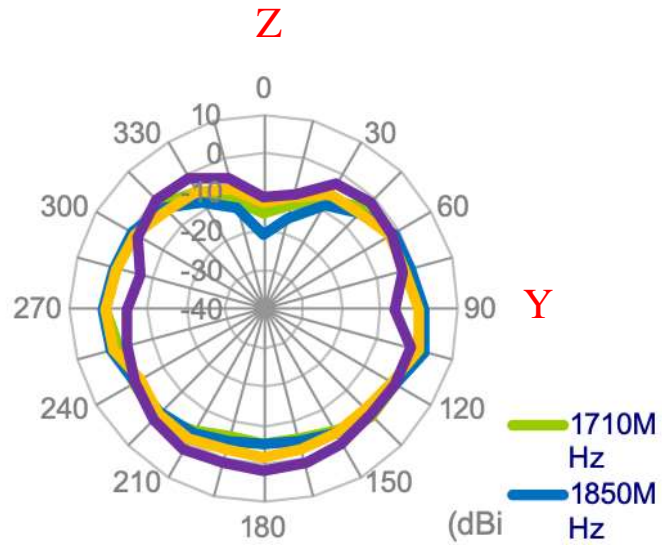

4.4 XY plane (Antenna with 1 meter cable length on the 2mm ABS base)

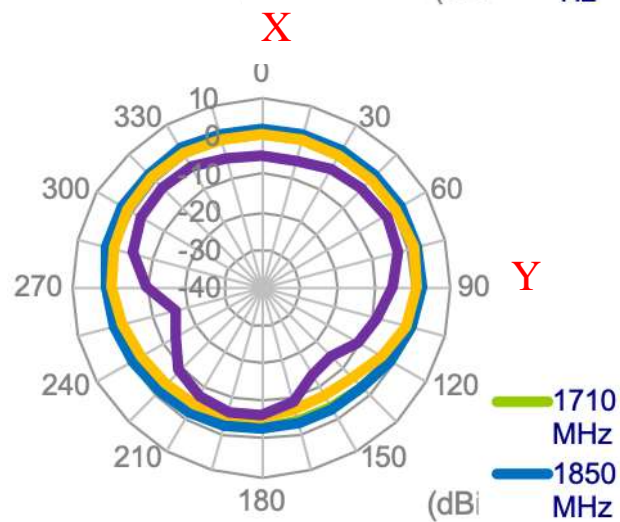
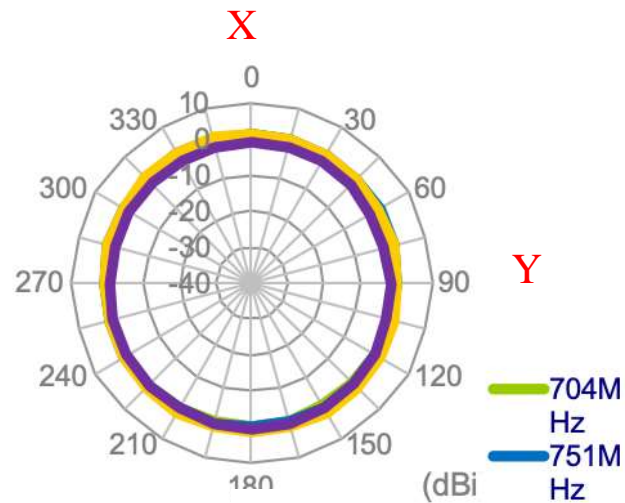
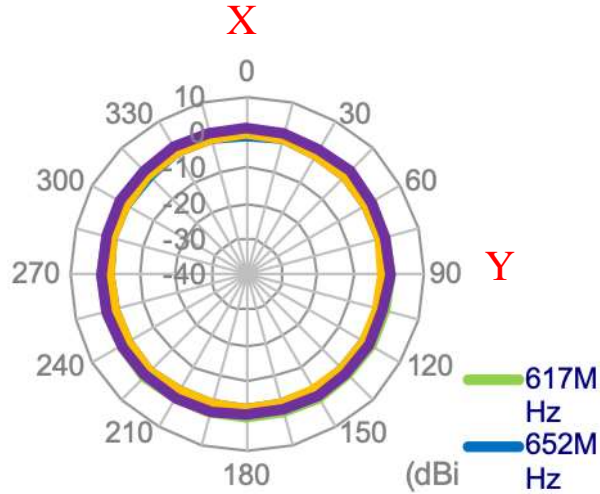

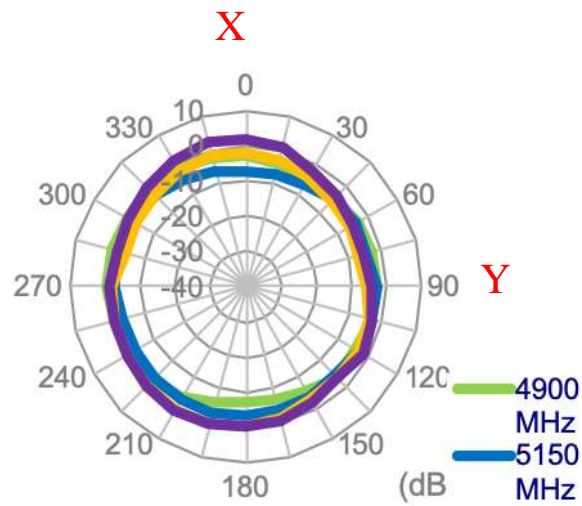
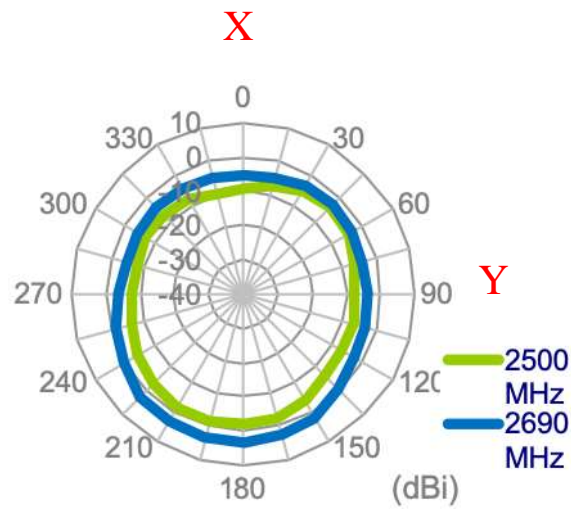

4.5 XZ plane (Antenna with 1 meter cable length on the 2mm ABS base)

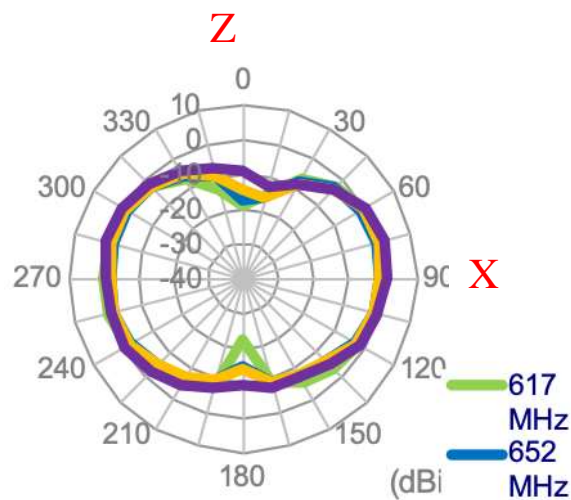

Z

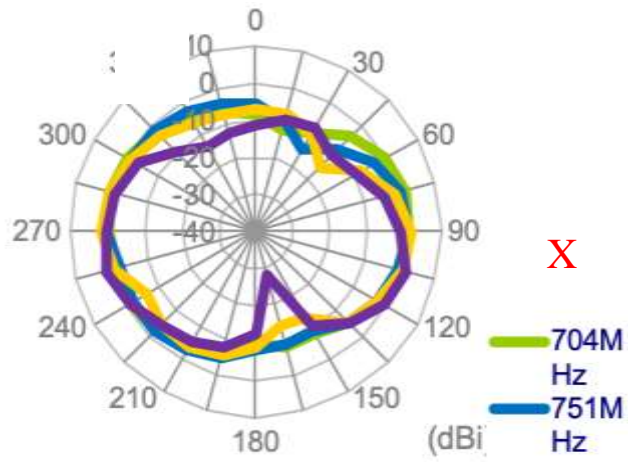

Z

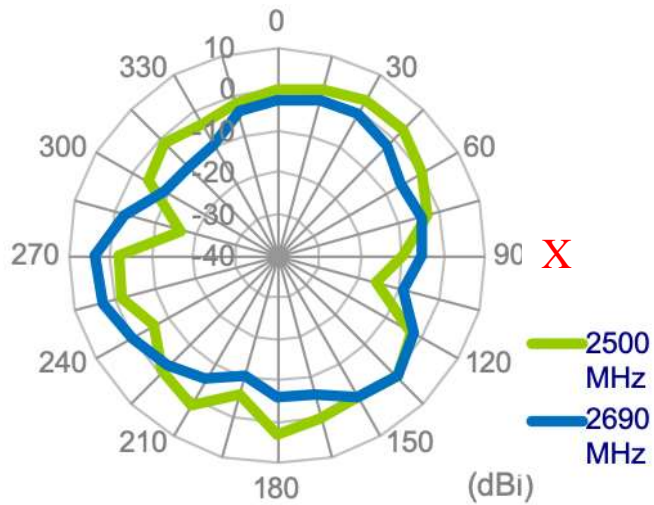
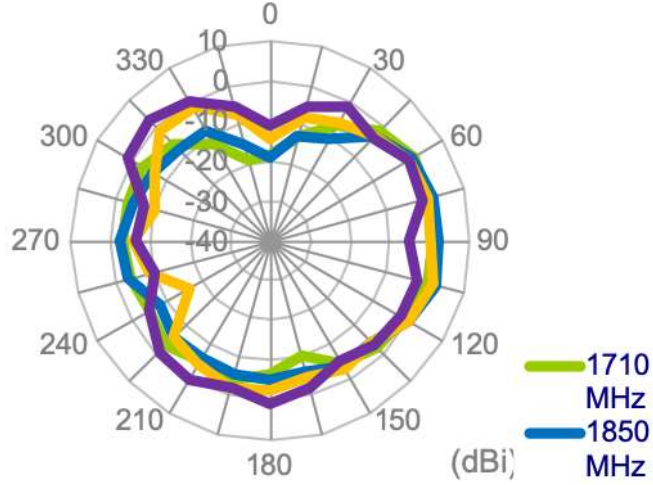

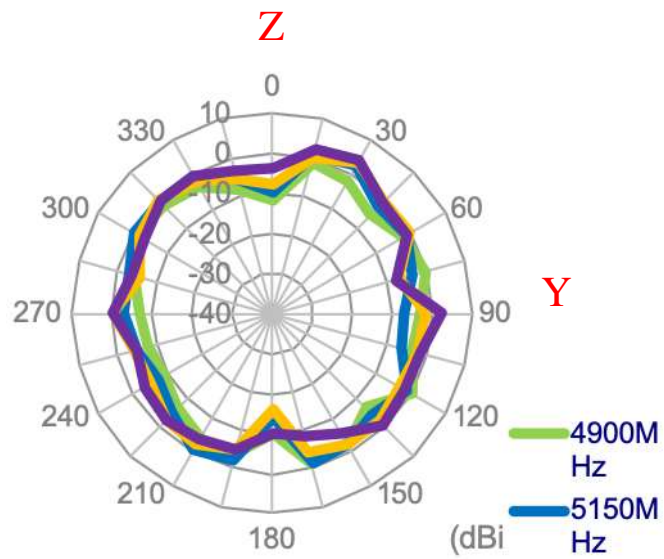

4.6 YZ plane (Antenna with 1 meter cable length on the 2mm ABS base)

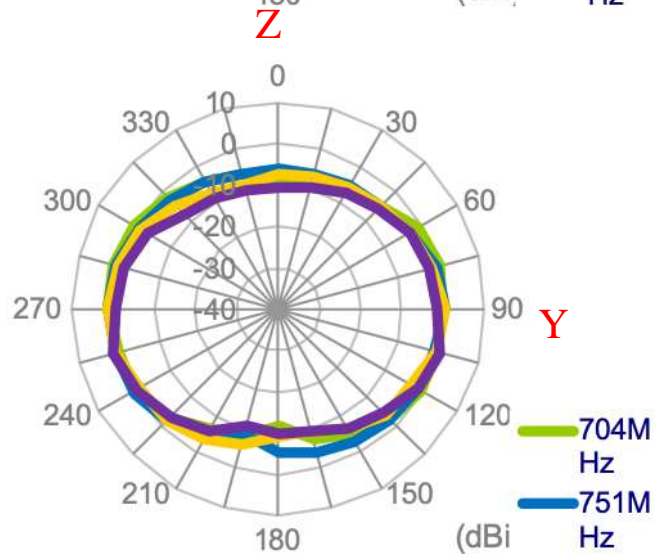
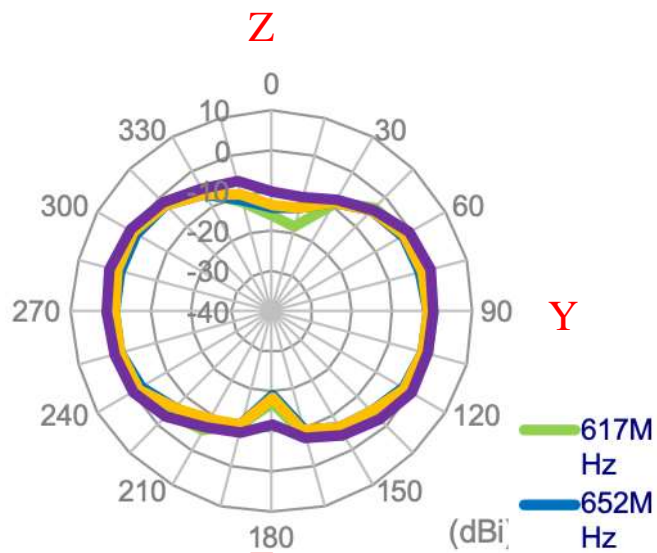

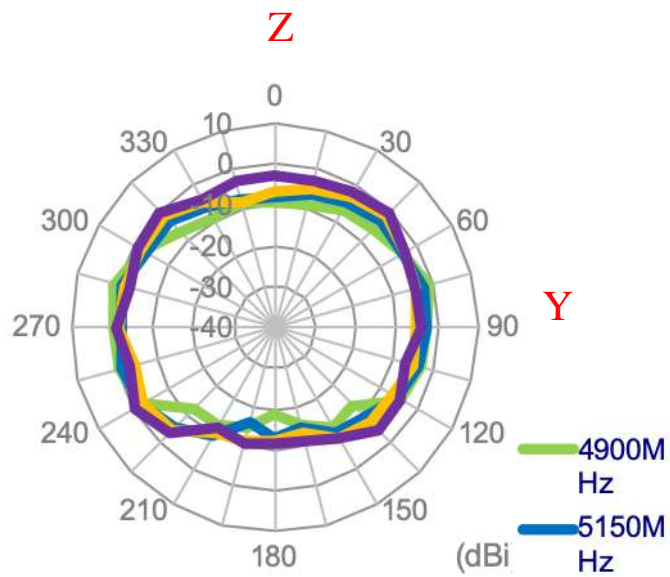
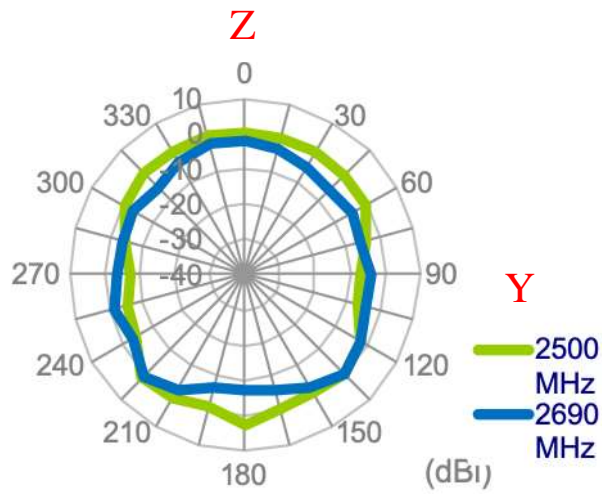
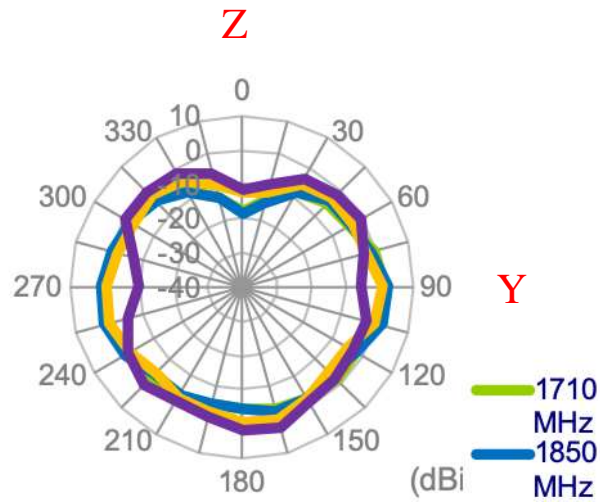

4.7 XY plane (Antenna with 1 meter cable length on the glass base)

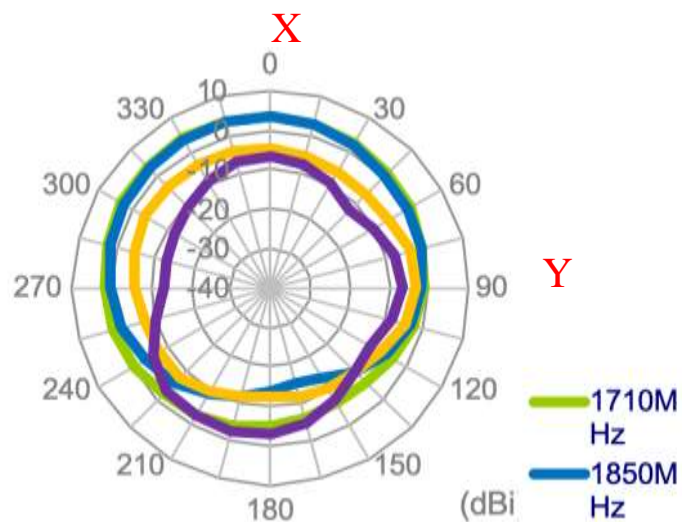
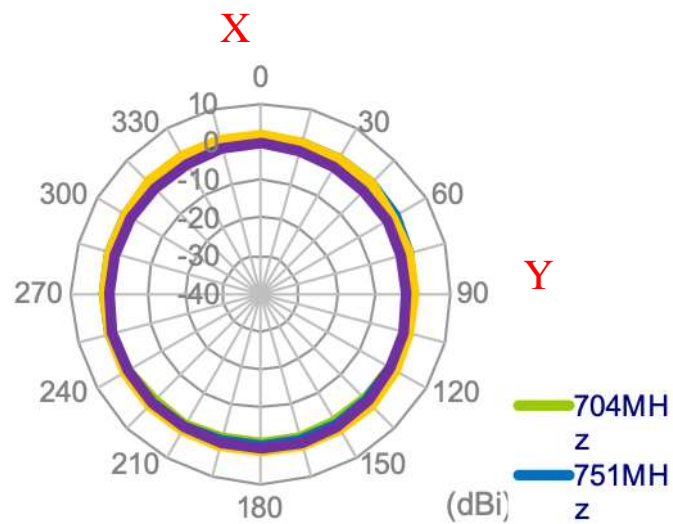
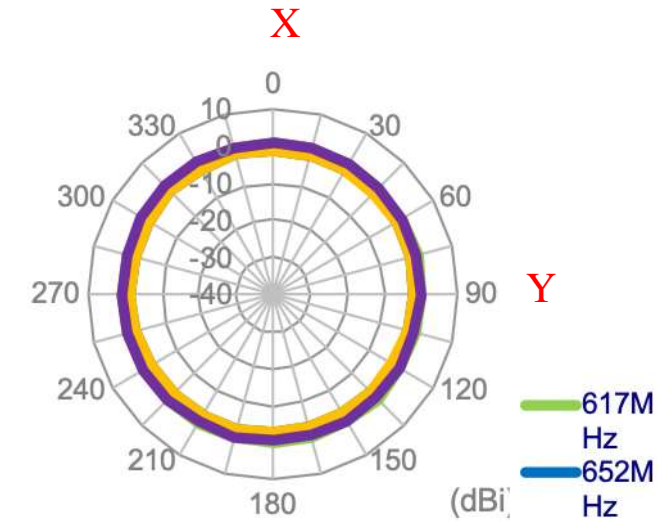

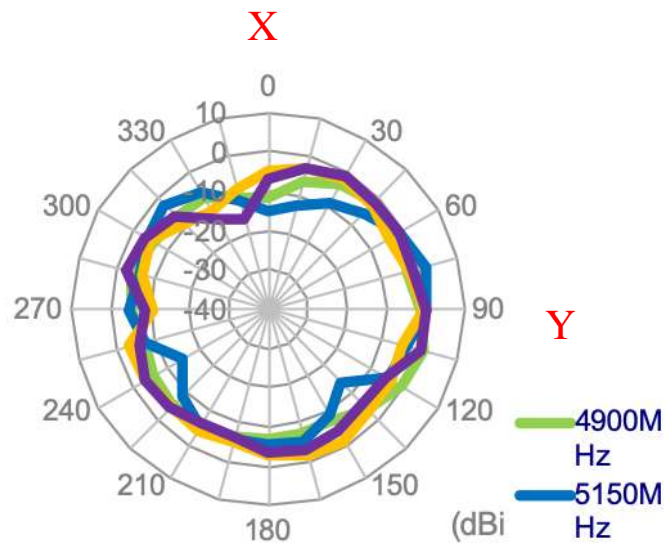
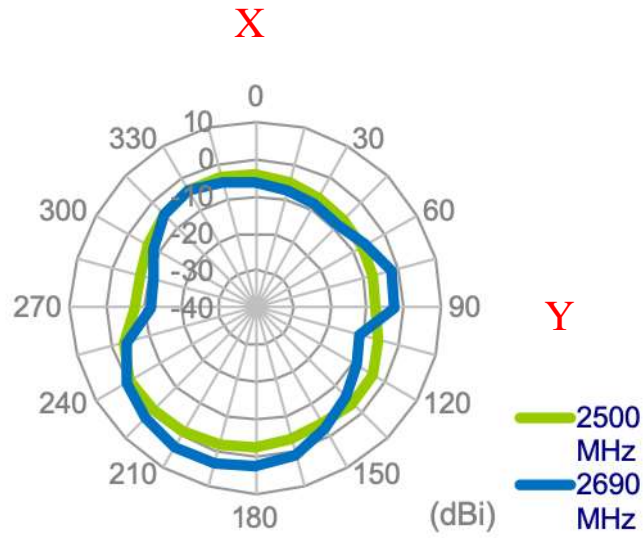

4.7 XZ plane (Antenna with 1 meter cable length on the glass base)

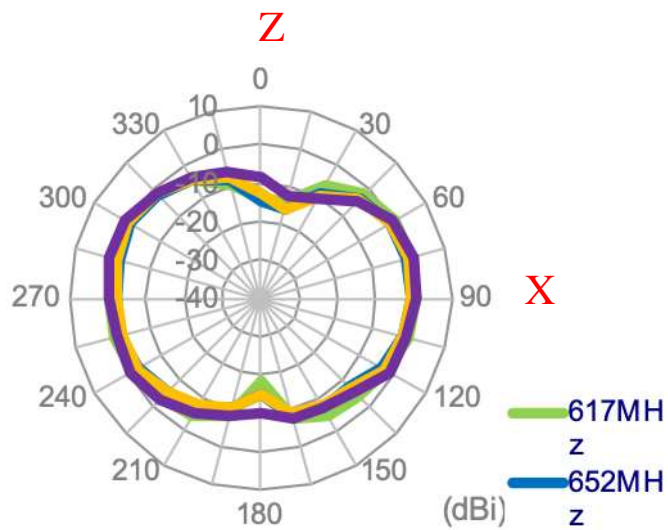

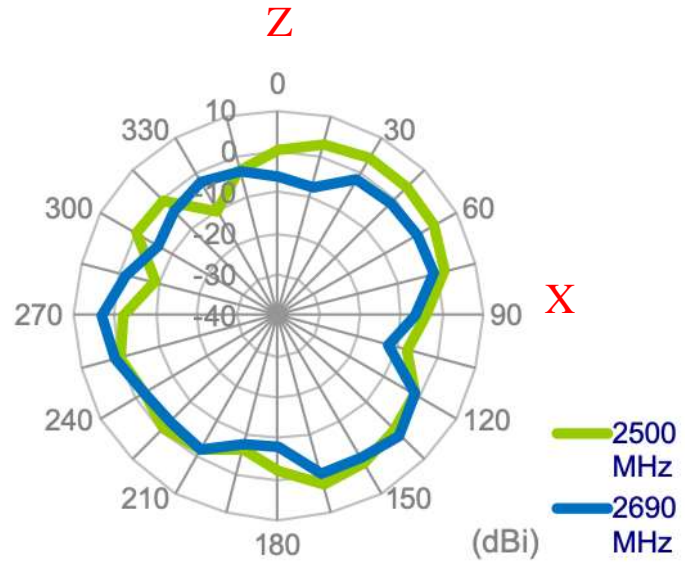
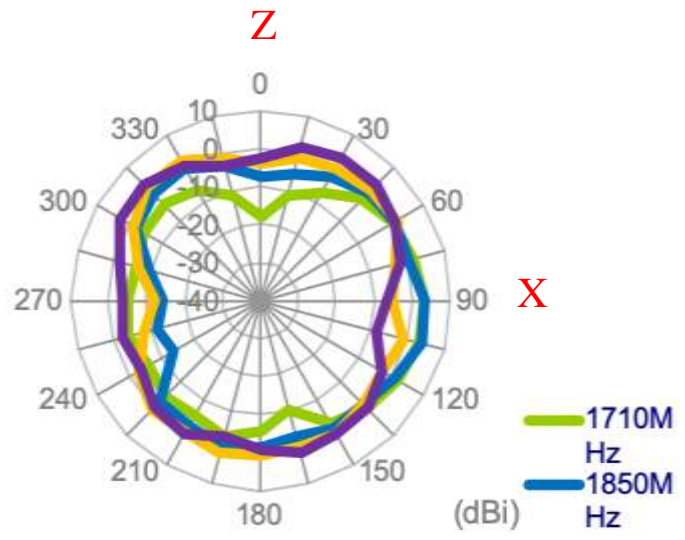
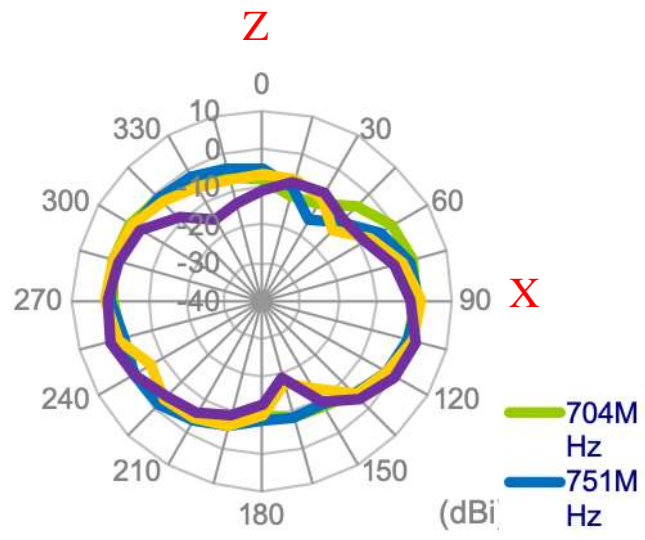

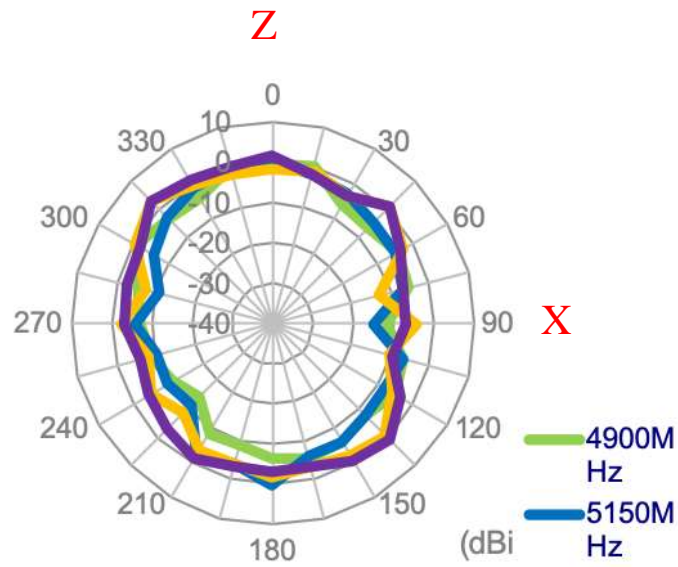

4.8 YZ plane (Antenna with 1 meter cable length on the glass base)

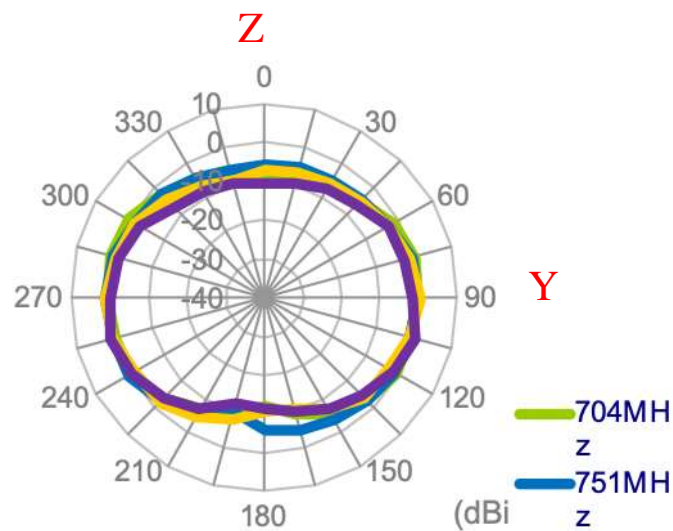
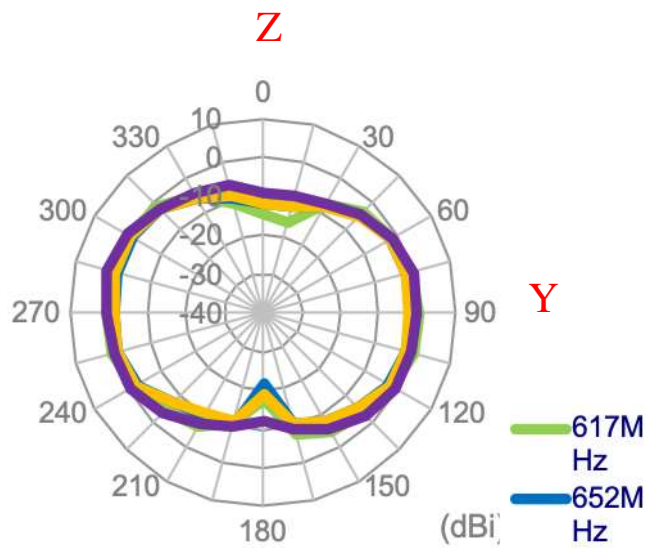

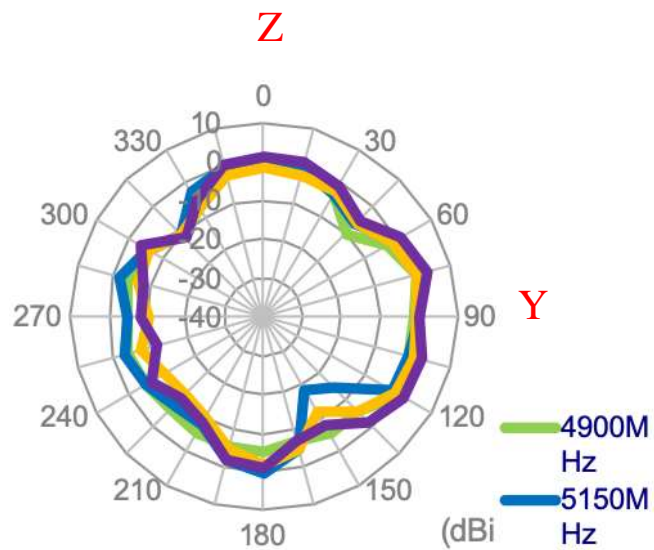
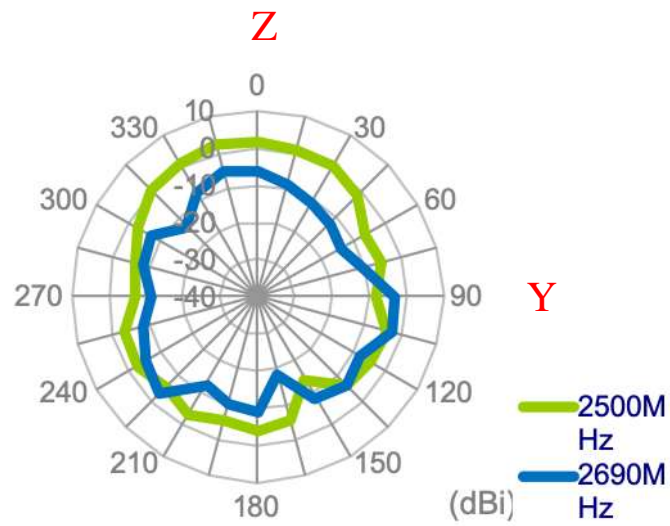
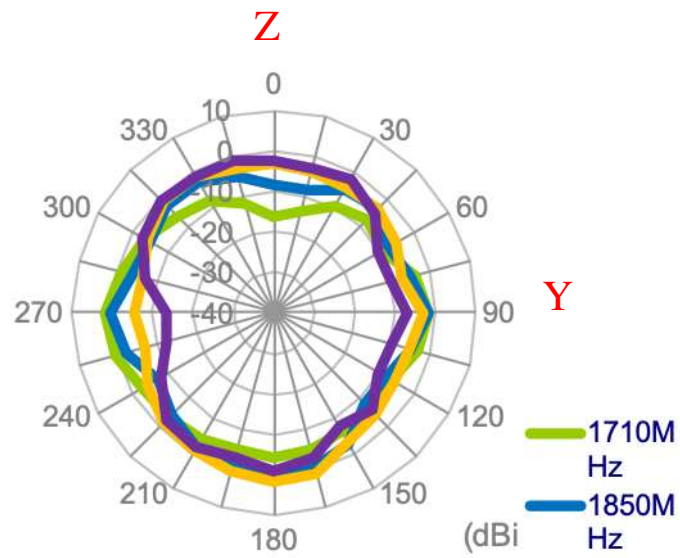

4.9 3D Radiation Pattern in free space

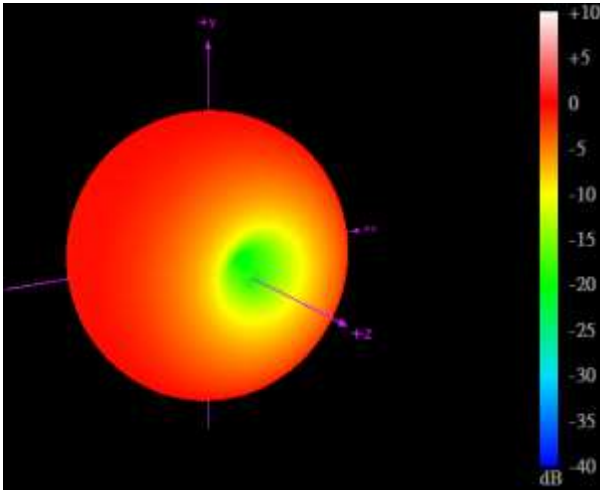

617 MHz

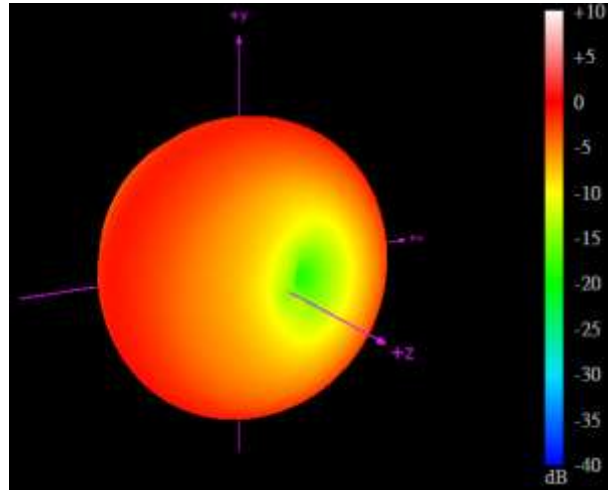

704 MHz

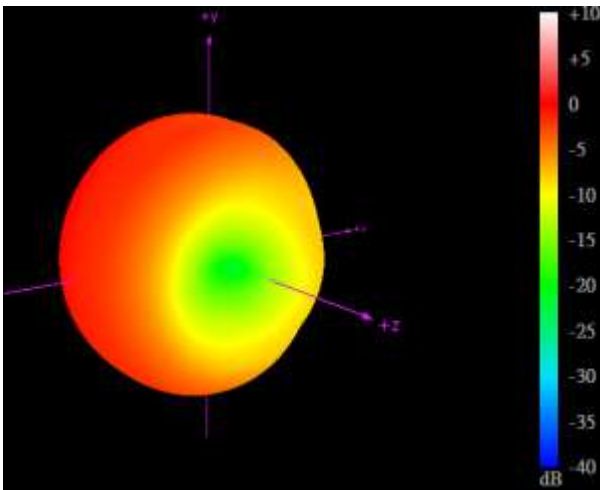

960 MHz

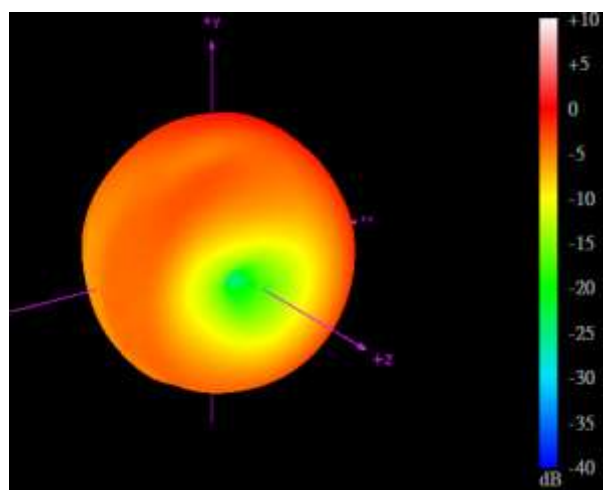

1710 MHz

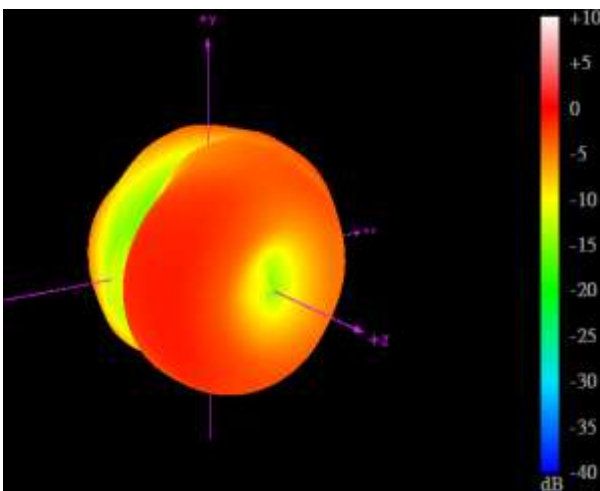

2170 MHz

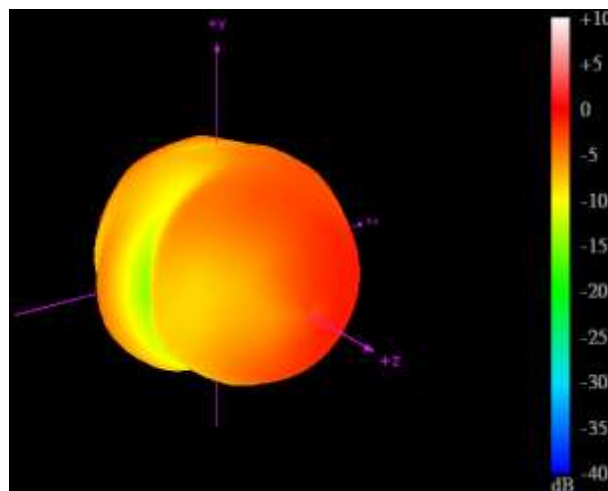

2500 MHz

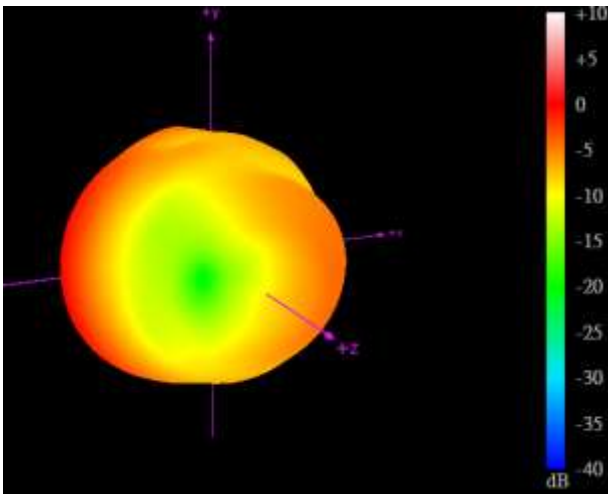

2690 MHz

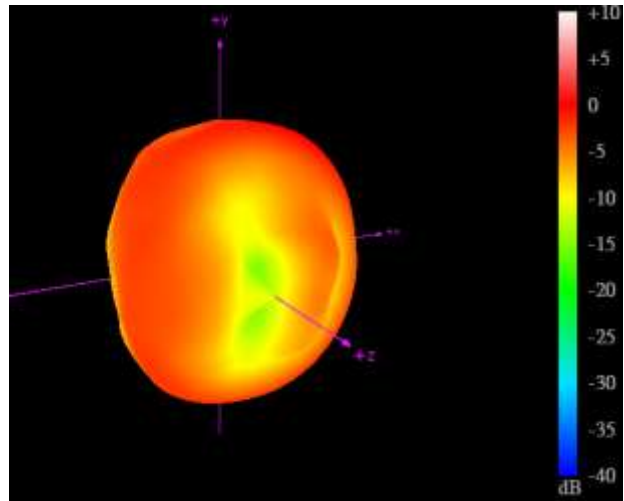

4900 MHz

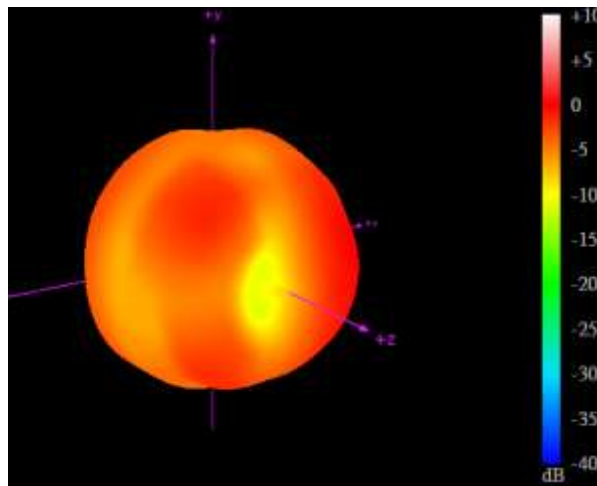

5850 MHz

4.10 3D Radiation Pattern on the 2mm ABS base

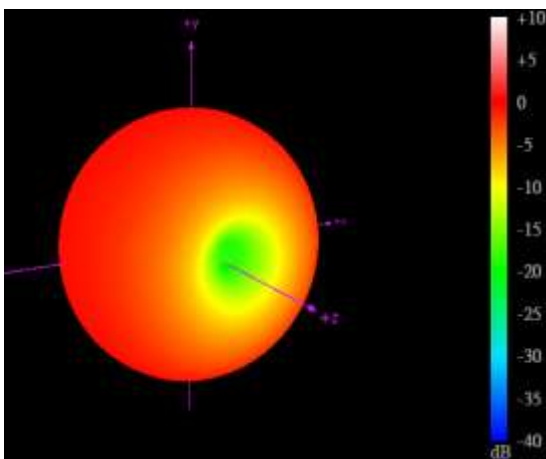

617 MHz

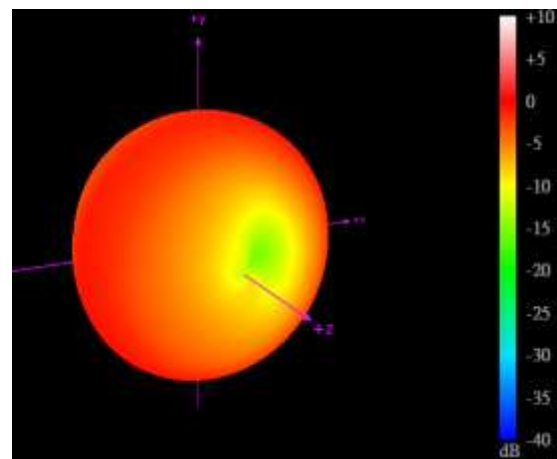

704 MHz

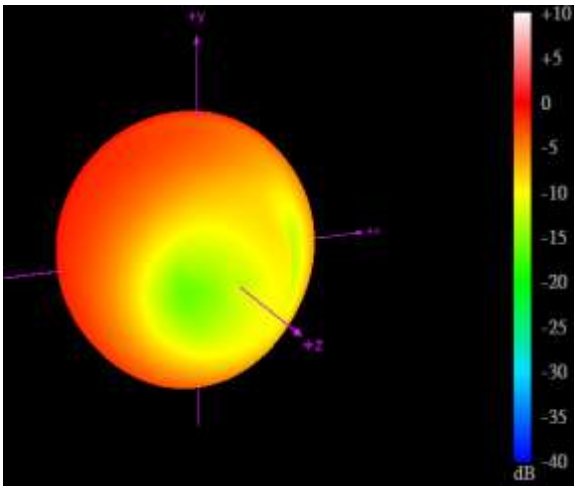

960 MHz

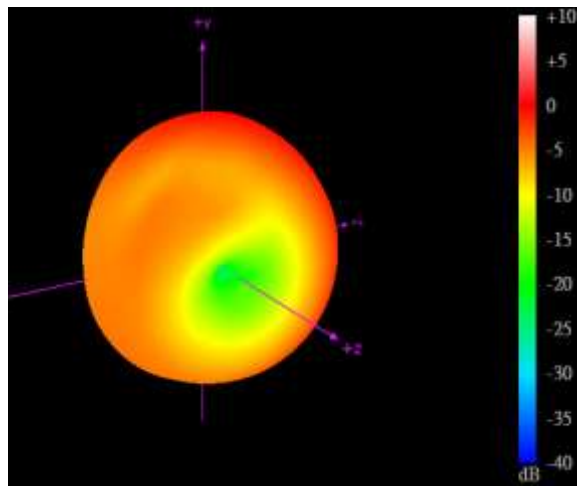

1710 MHz

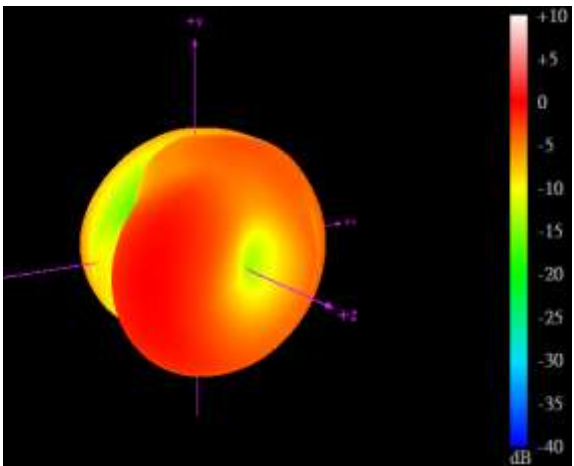

2170 MHz

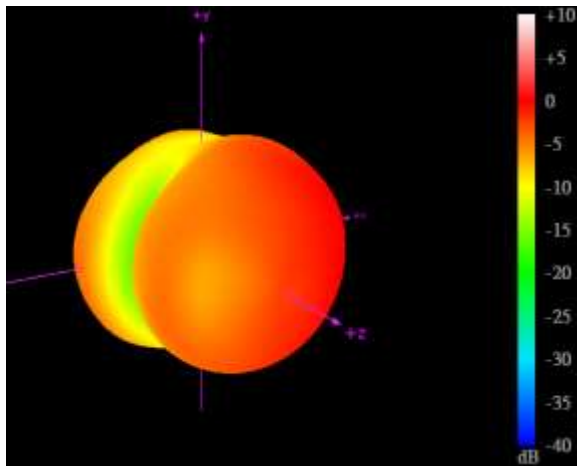

2500 MHz

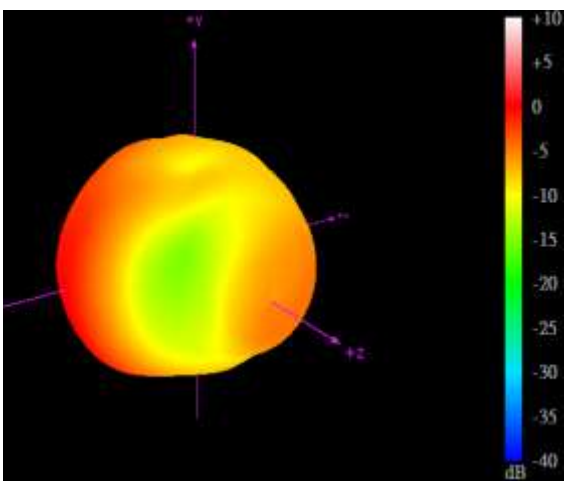

2690 MHz

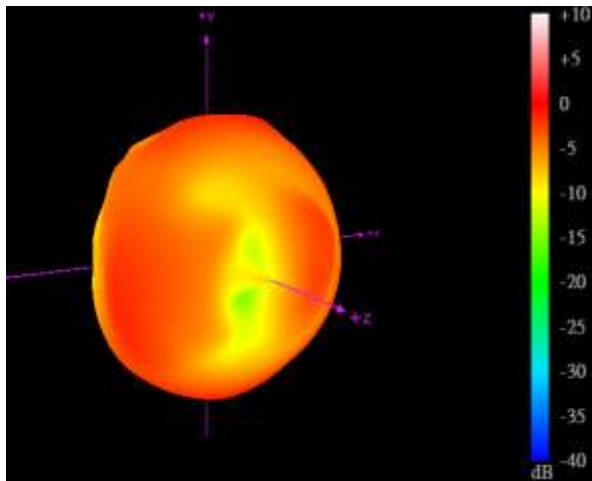

4900 MHz

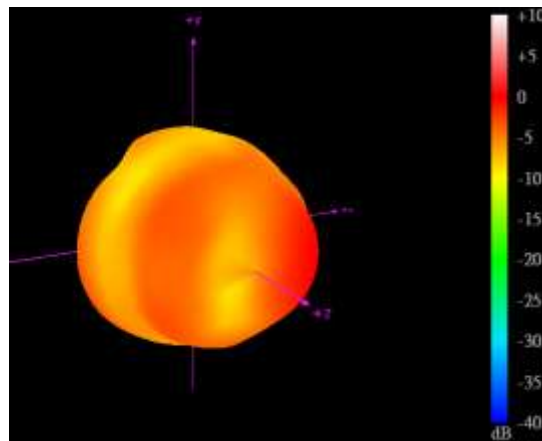

5850 MHz

4.11 3D Radiation Pattern on the glass base

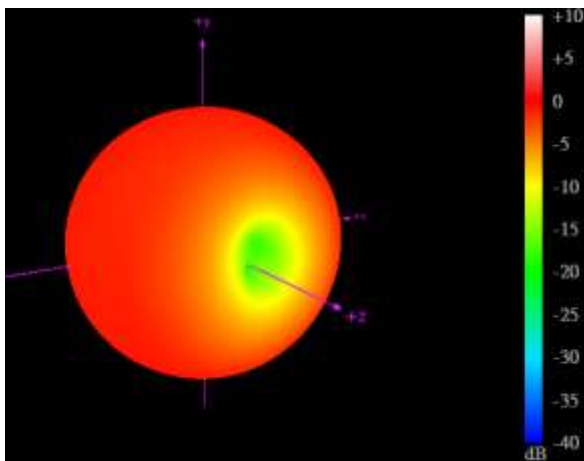

617 MHz

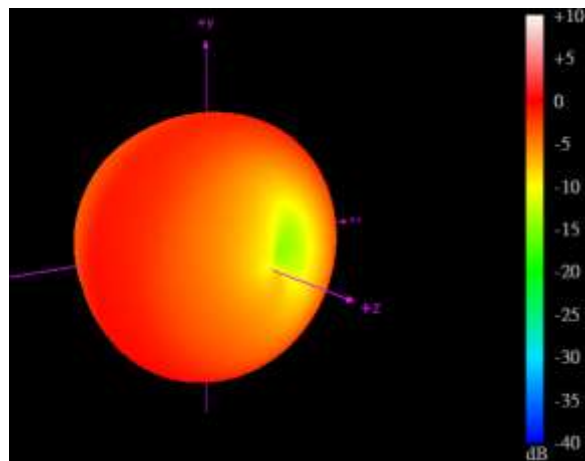

704 MHz

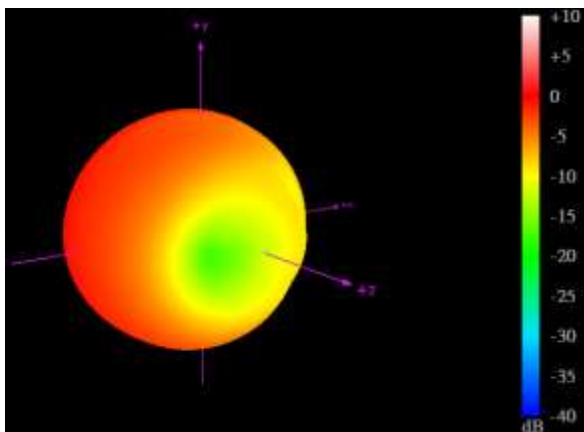

960 MHz

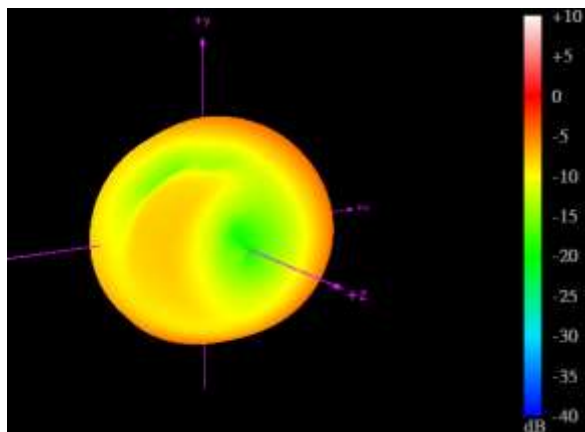

1710 MHz

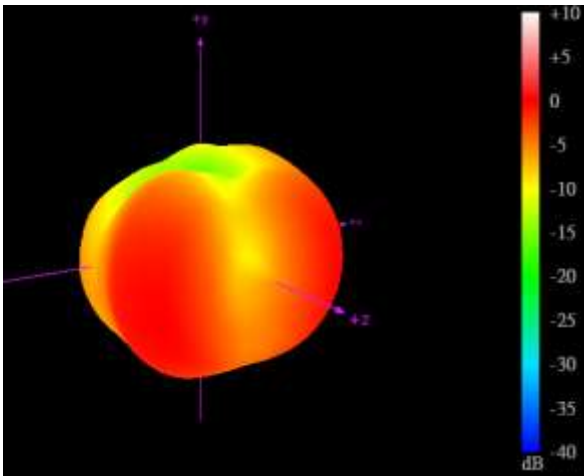

2170 MHz

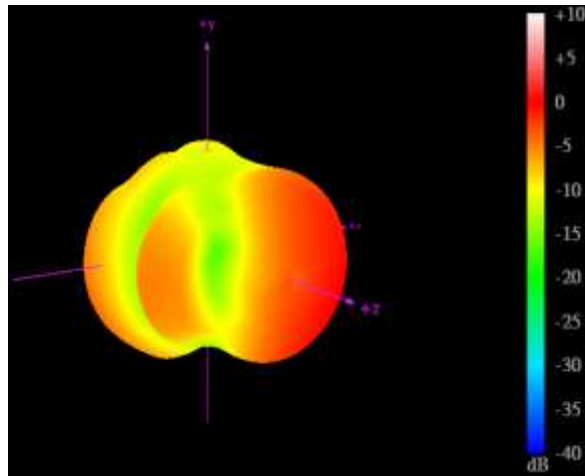

2500 MHz

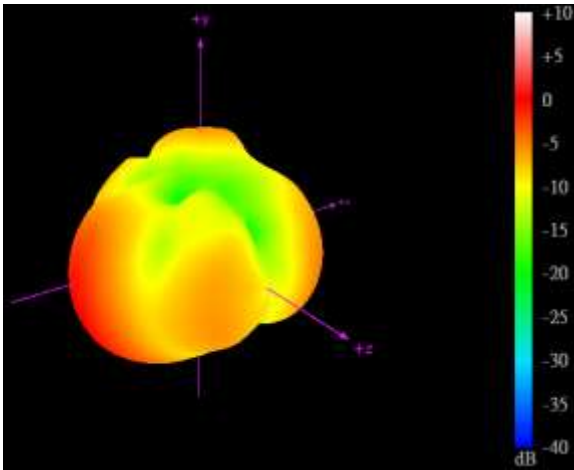

2690 MHz

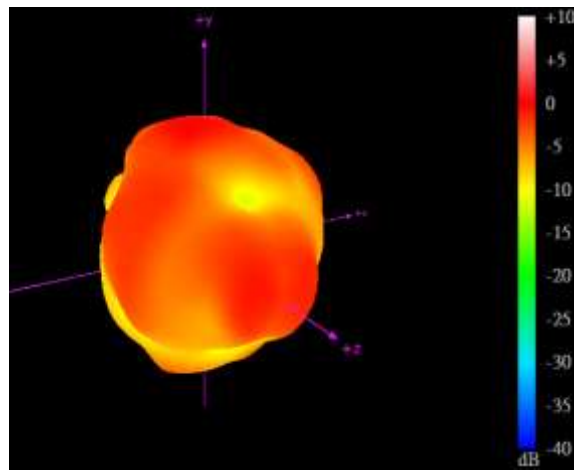

4900 MHz

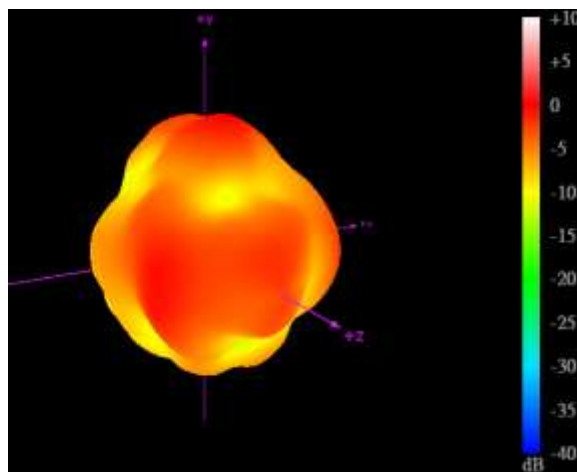

5850MHz

5. Mechanical Drawing (Unit: mm)

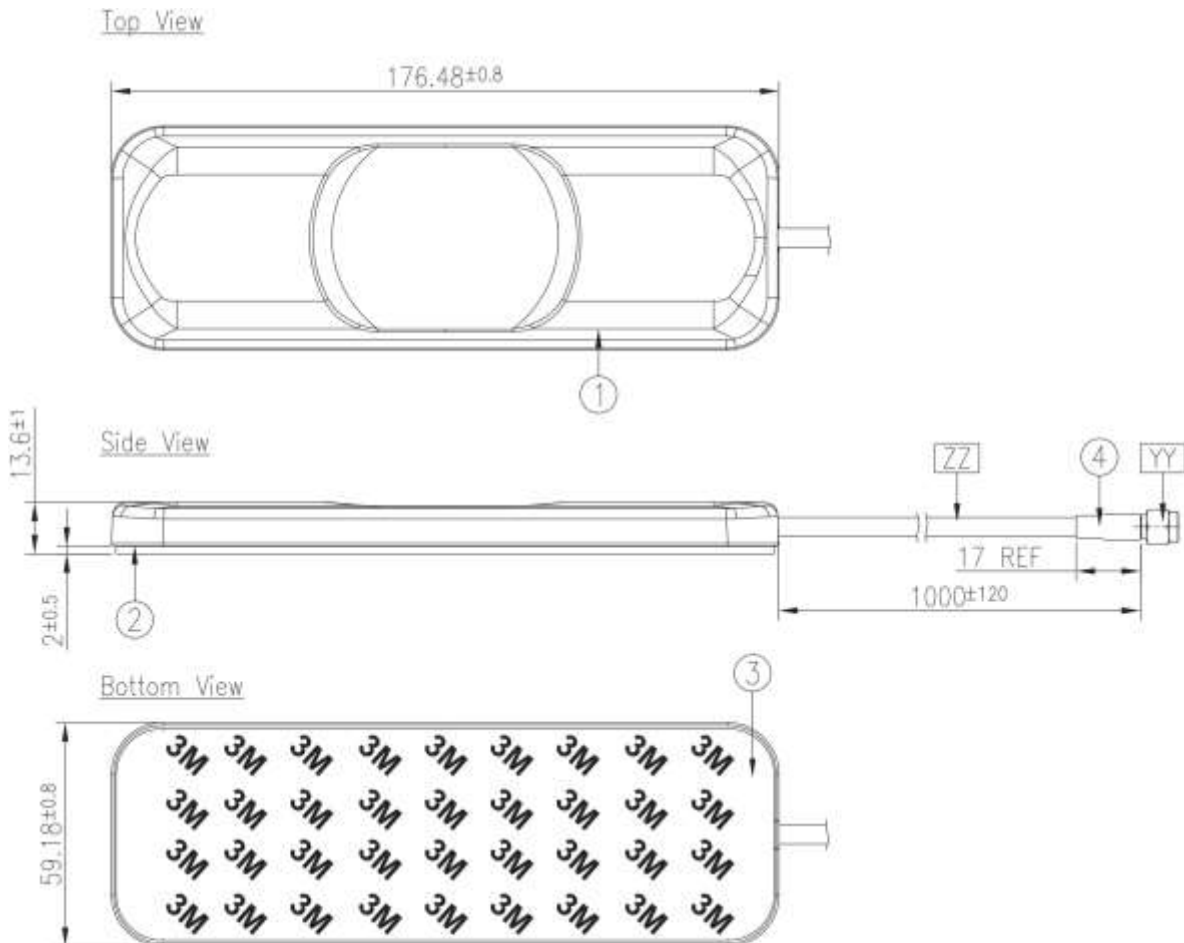

	Name	Material	Finish	QTY
1	Housing Top	ABS	Black	1
2	Housing Bottom	ABS	Black	1
3	Double Sided Adhesive (Black Foam)	3M9448BK+CR4305	White Liner	1
4	Heat Shrink Tube	PE	Black	1

	Name	Spec	Finish	QTY
YY	Connector Type	SMA(M)ST	Au Plated	1
ZZ	Cable Type	CF0200	Black	1

6. Packaging (Unit: mm)

1pc GSA.8842.A.105111 per PE bag
Bag Dimensions - 290*160 mm
Weight - 124g

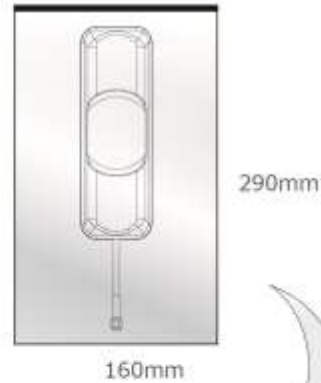

40pcs GSA.8842.A.105111 per carton
Carton Dimensions - 370*370*300 mm
Weight - 6.4Kg

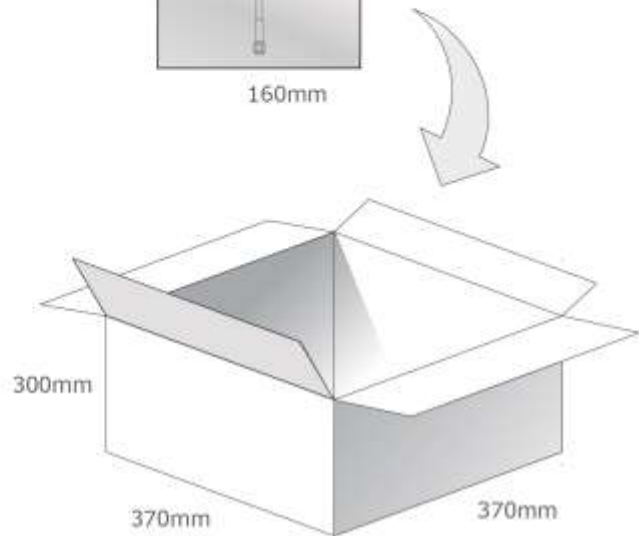

Pallet Dimensions 1200mm*1000mm*1400mm
24 Cartons per Pallet
6 Cartons per layer
4 Layers

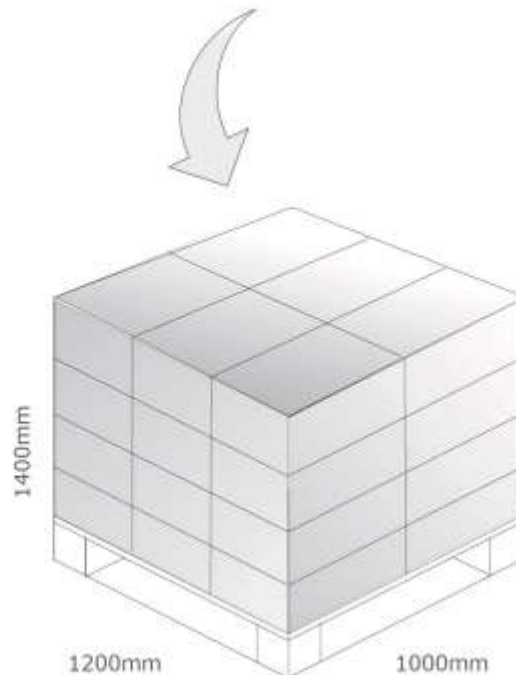

7. Application Note

The GSA.8842 antenna performance with different cable lengths and different mounting environments is shown below.

7.1 Return Loss (in free space)

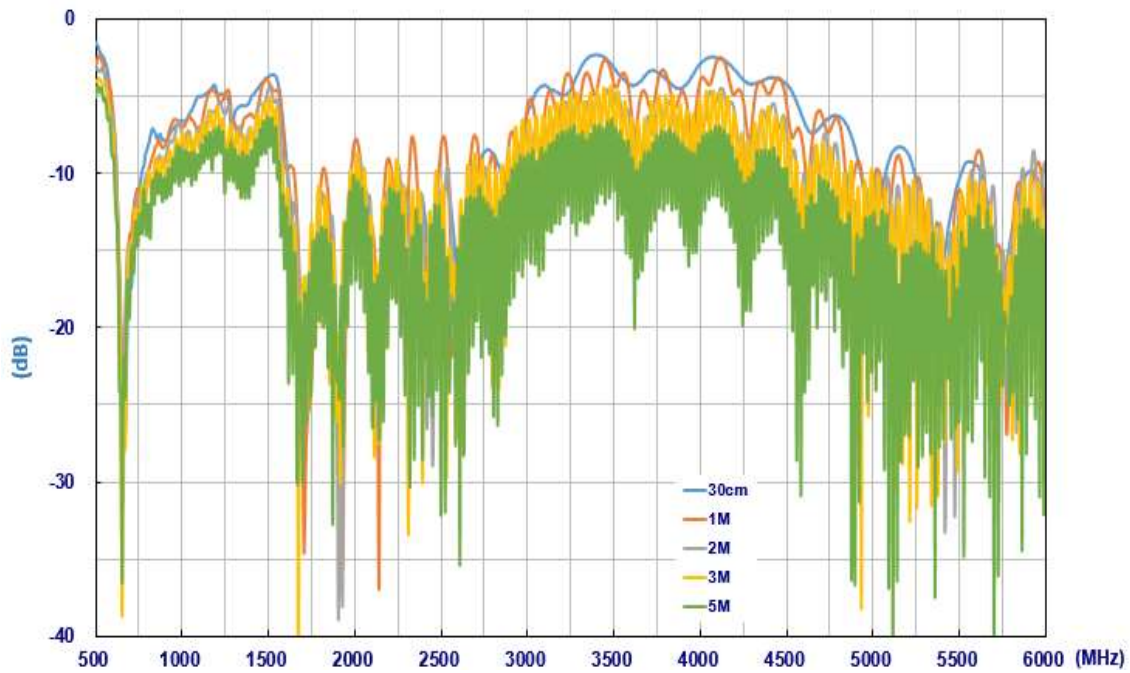

Figure 5. Return loss of GSA.8842 Antenna with different cable lengths

7.2 Efficiency (in free space)

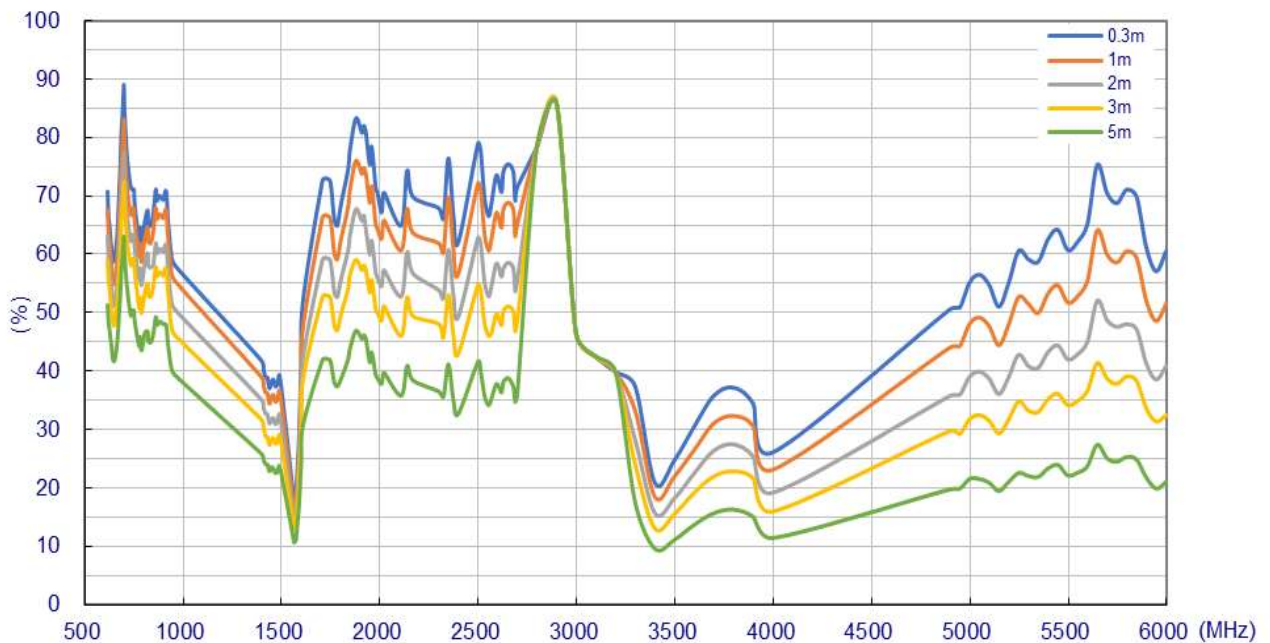

Figure 6. Efficiency of GSA.8842 Antenna with different cable lengths

7.3 Average Gain (in free space)

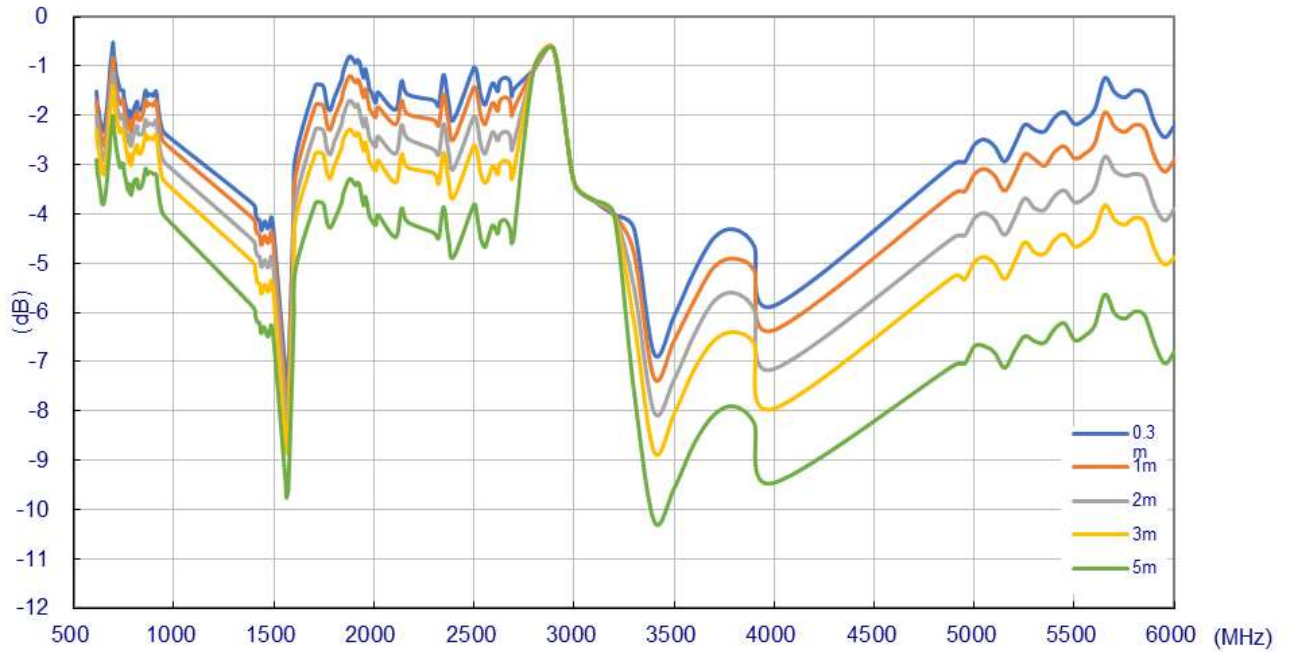

Figure 7. Average Gain of GSA.8842 Antenna with different cable lengths

7.4 Peak Gain (in free space)

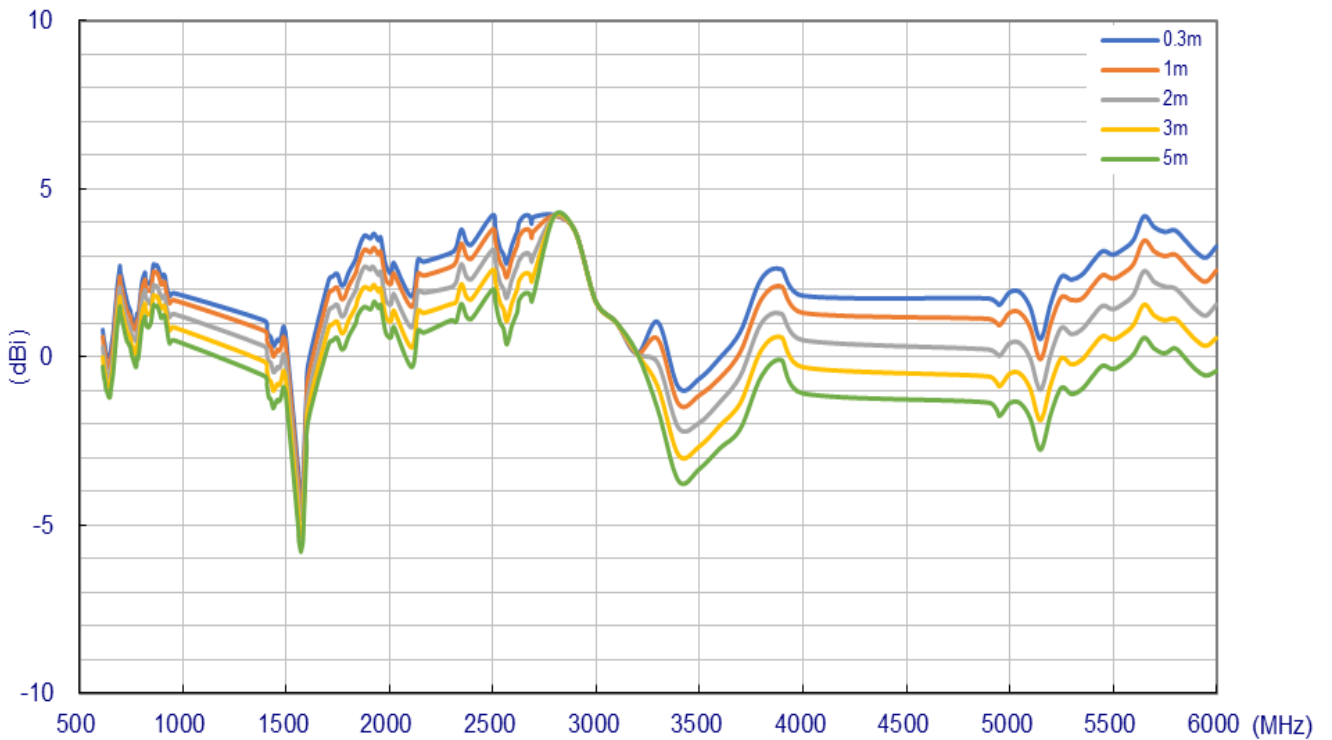

Figure 8. Peak Gain of GSA.8842 Antenna with different cable lengths

7.5 Return Loss (on the 2mm ABS base)

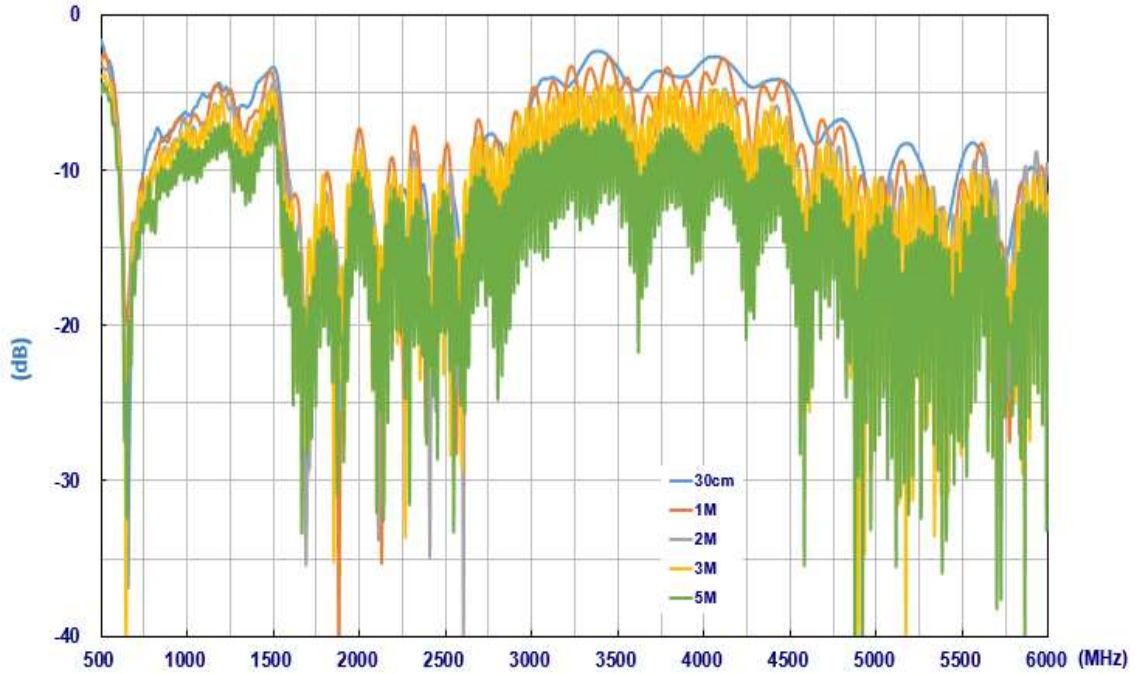

Figure 9. Return loss of GSA.8842 Antenna with different cable lengths

7.6 Efficiency (on the 2mm ABS base)

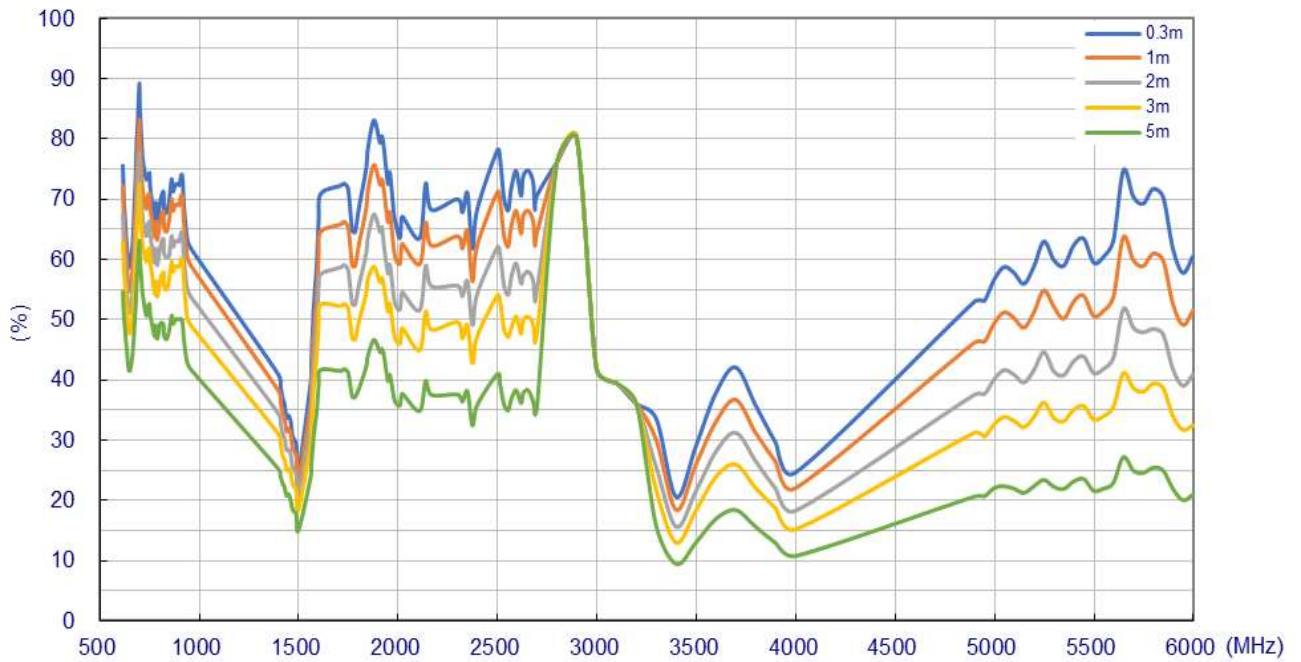

Figure 10. Efficiency of GSA.8842 Antenna with different cable lengths

7.7 Average Gain (on the 2mm ABS base)

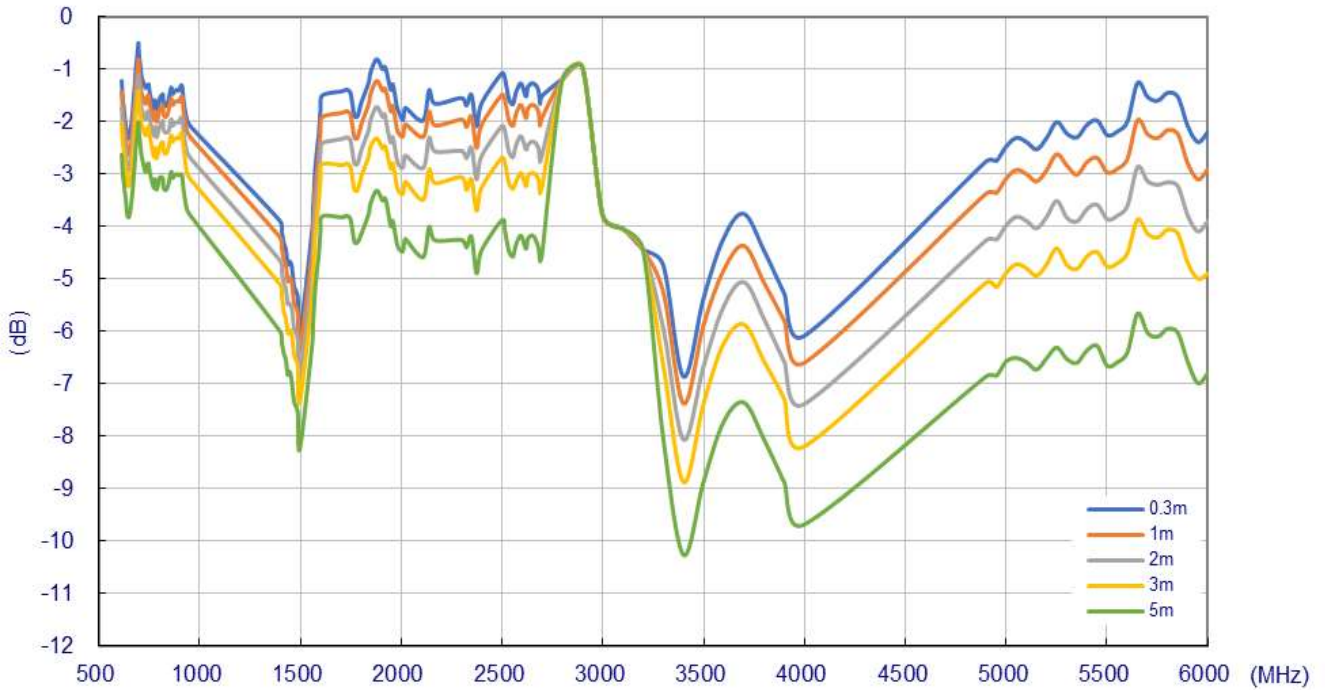

Figure 11. Average Gain of GSA.8842 Antenna with different cable lengths

7.8 Peak Gain (on the 2mm ABS base)

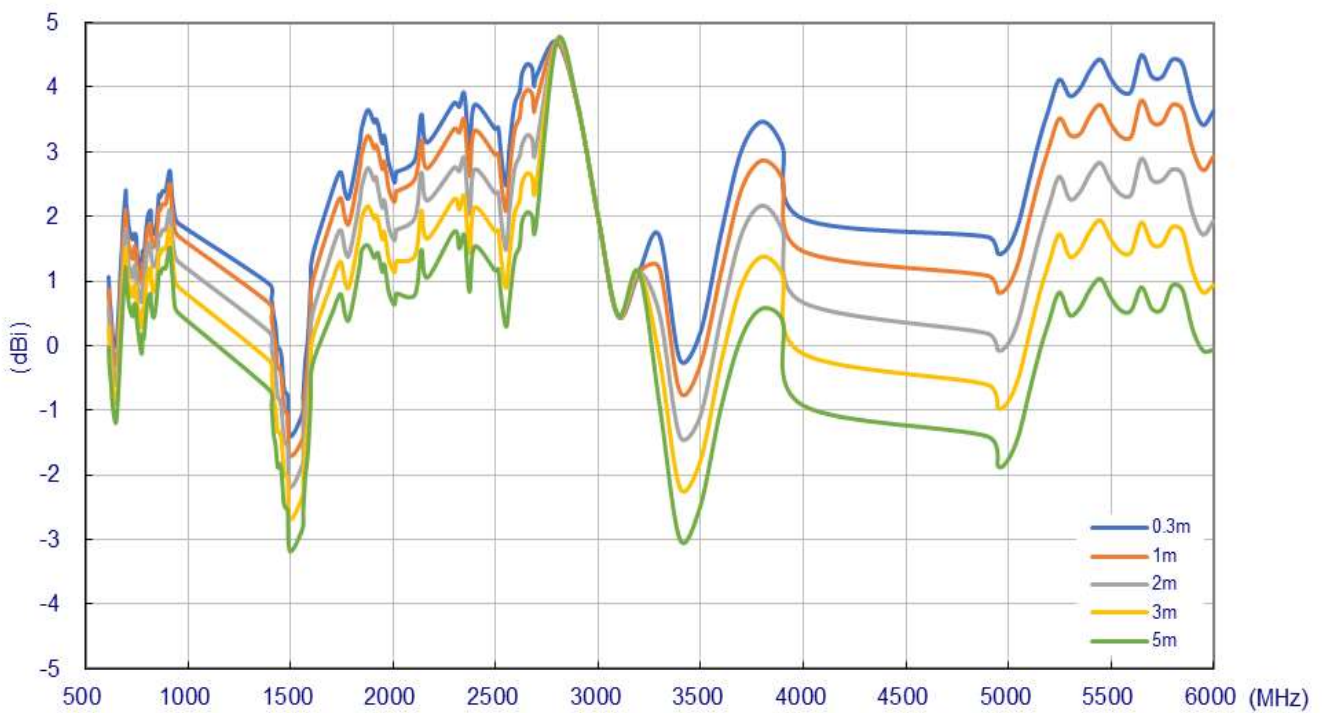

Figure 12. Peak Gain of GSA.8842 Antenna with different cable lengths

7.9 Return Loss (on the glass base)

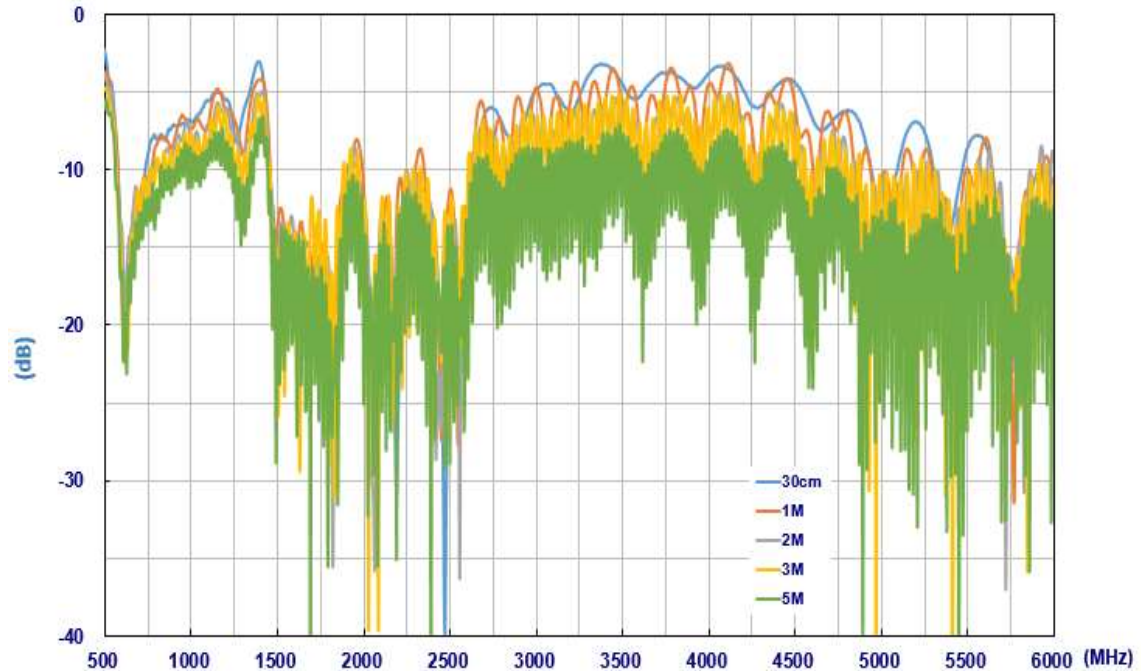

Figure 13. Return loss of GSA.8842 Antenna with different cable lengths

7.10 Efficiency (on the glass base)

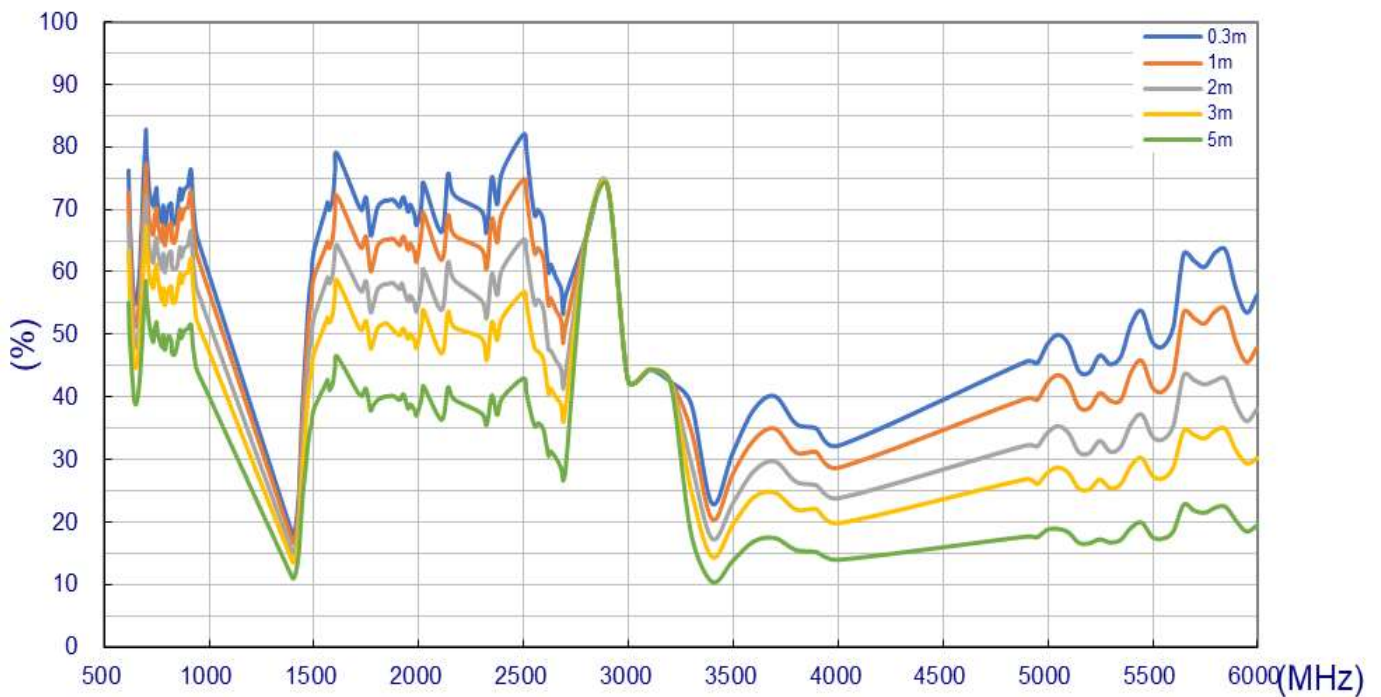

Figure 14. Efficiency of GSA.8842 Antenna with different cable lengths

7.11 Average Gain (on the glass base)

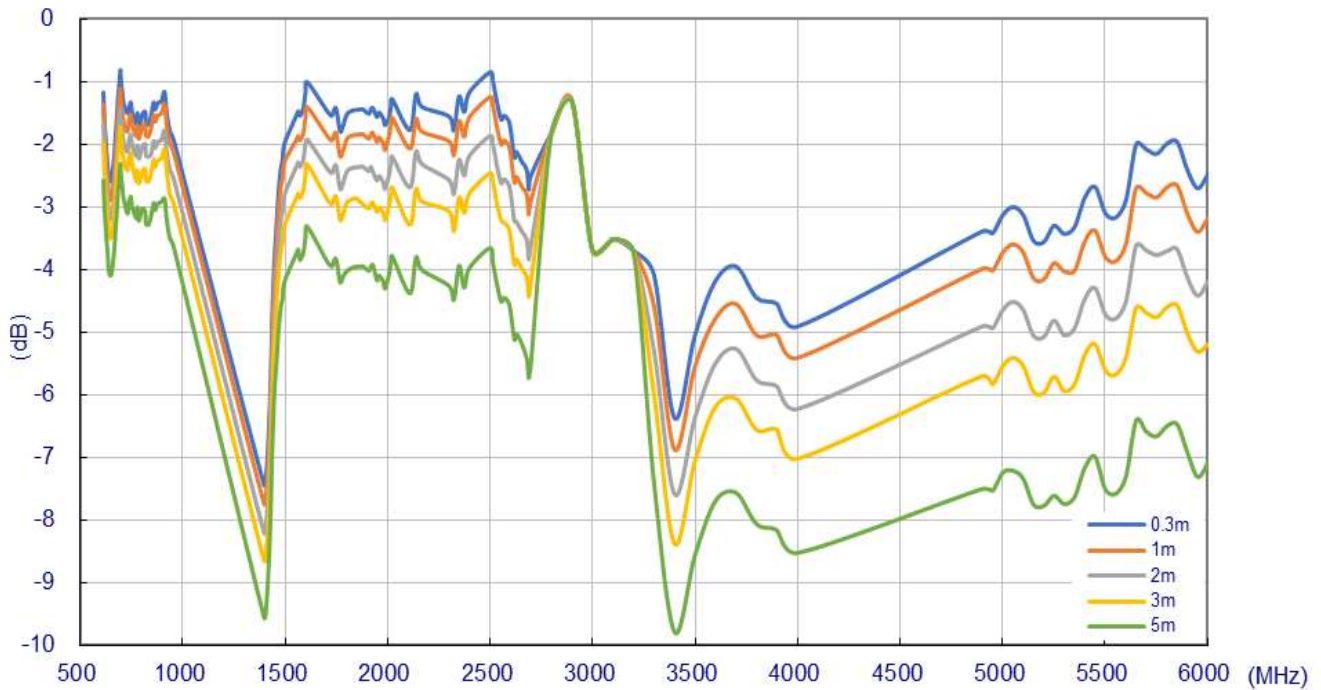

Figure 15. Average Gain of GSA.8842 Antenna with different cable lengths

7.12 Peak Gain (on the glass base)

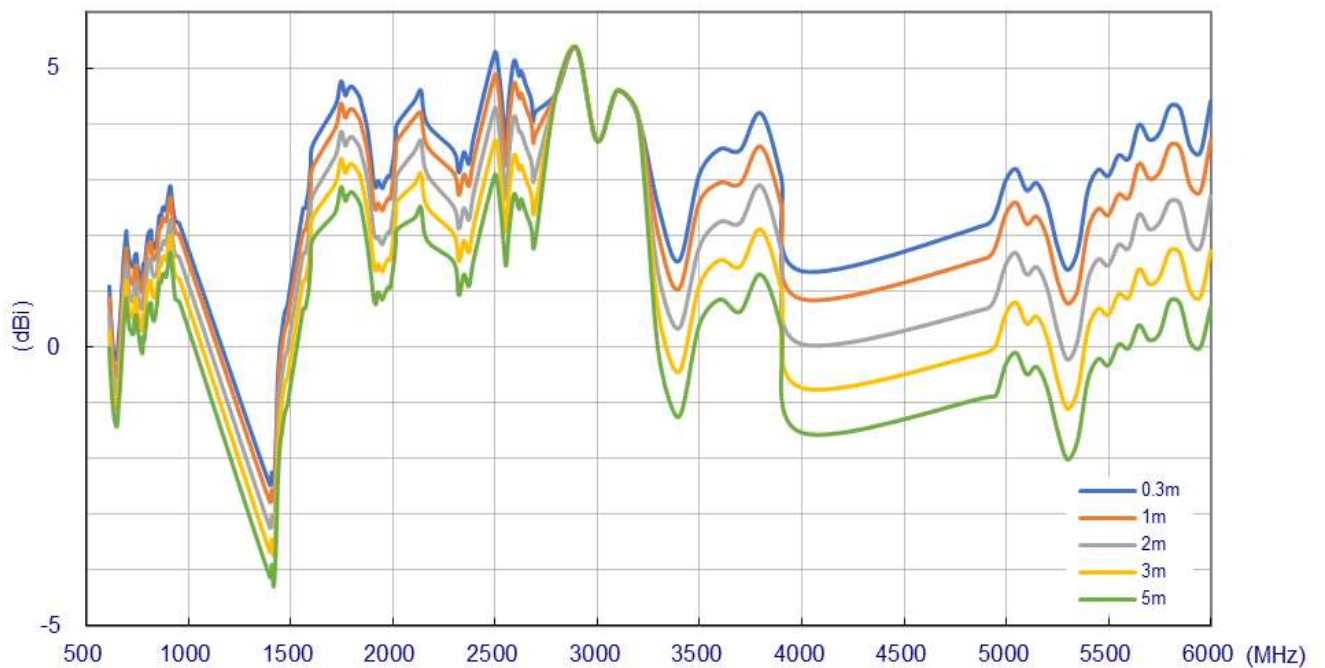

Figure 16. Peak Gain of GSA.8842 Antenna with different cable lengths

Taoglas makes no warranties based on the accuracy or completeness of the contents of this document and reserves the right to make changes to specifications and product descriptions at any time without notice. Taoglas reserves all rights to this document and the information contained herein.

Reproduction, use or disclosure to third parties without express permission is strictly prohibited.

© Taoglas