



### SPECIFICATIONS

Model	Stroke mm	Max Energy Absorption J(kgf·m)	Max Equiv. Mass kg(kgf)	Range of Impact Rate m/s
FA-4275B3-C	75	780(79.6)	9700(9700)	0.3~3

### COMMON SPECIFICATIONS

Max Drag N(kgf)	Max Cycle Rate cycle/min	Max Energy Absorption per min. J/min(kgf·m/min)	Extension Force N(kgf)	Operating Temp. C°	Mass g
31590(3223)	6	3345(341)	120(12.2)	-5~70	1240

### PRECAUTIONS FOR USE

- Do not use this product without carefully reading the attached owner's manual.
- Ensure that an external stopper (Stopper nut OP-020M42) is also used.
- Do not turn the oil inlet screw located at the bottom of the main unit.
- Ensure that sufficient mounting strength is secured for this product. (As a guideline, it should be 2 to 3 times the maximum drag listed in the catalogue.)
- Do not use this product in a vacuum or a location where it may come in contact with oil.
- Ensure that an eccentric load is not applied to the soft absorber. (Allowable eccentric angle: within  $\pm 2.5^\circ$ )
- The urethane caps are consumables. Please replace them when necessary.

### ADJUSTMENT METHOD

- To adjust, turn the adjustment knob located at the bottom of the main unit.
- Because the adjustment can be done in an analog manner, a value between two integers on the indicator can be set.
- Once the adjustment is complete, secure with a lock screw using a hex wrench.

### OPTIONAL PARTS

#### Square Flange OP-040 M42SF

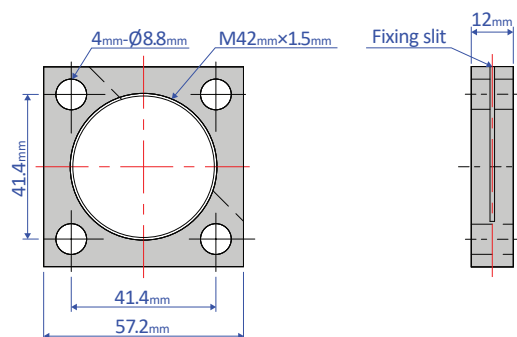

Mass 153g

#### Rectangle Flange OP-040 M42RF

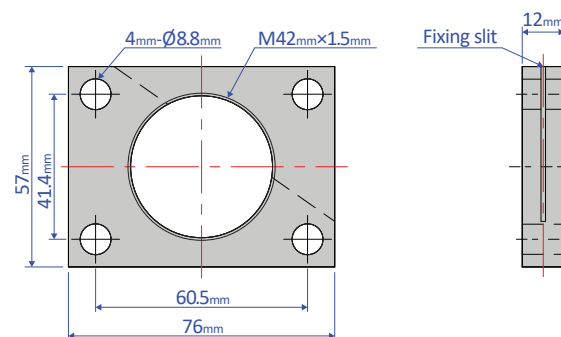

Mass 251g

## OPTIONAL PARTS

### Eccentric angle adaptor OP-010M4250

- Screw the eccentric angle adaptor into the main unit until the cap for the eccentric angle and the piston rod form a tight connection. While maintaining this position, fasten the main unit's nut until it is secured.
- Use the eccentric angle adaptor when the eccentric angle is 2.5° or larger.
- The main unit can also be used as a stopper.
- Use it with a capless soft absorber.
- The maximum operating eccentric angle with an eccentric angle adaptor is  $\pm 10^\circ$ .
- Nut for unit is not inclusive.
- The caps and the guides for inclined use are not unbundled.

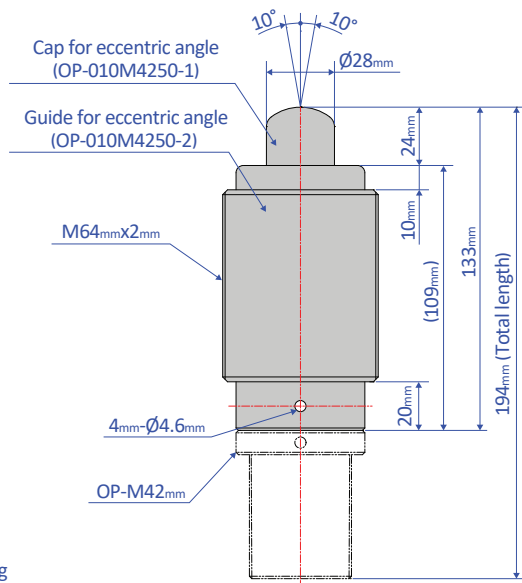

Mass 1600g

### Nut OP-M64

- Usable as the nut for eccentric angle adaptor

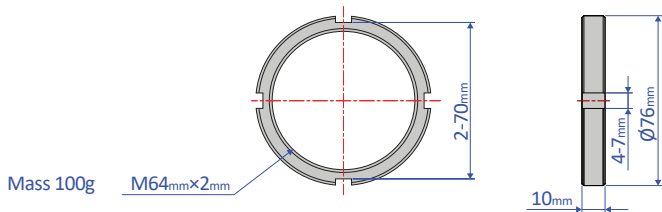

Mass 100g

### Nut OP-M42

Mass 64g

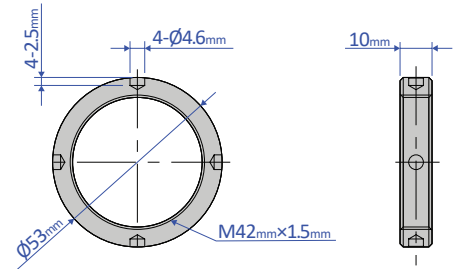

### Stopper Nut OP-20 M42

- Once the attachment site is determined, use the main unit's nut to securely fasten in place.

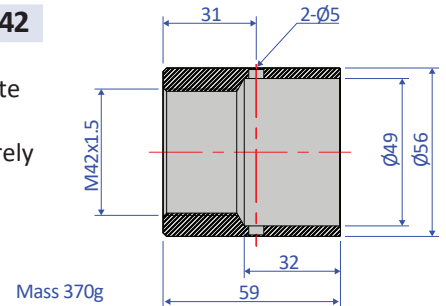

Mass 370g

### Side Mount OP-M42SM

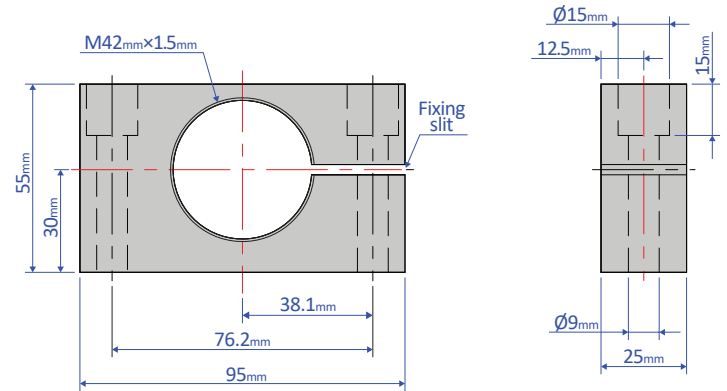

Mass 676g (1 unit)

- Side mount is sold as a set of two.
- Recommended bolt: M8 X 50 hexagon socket head bolt

### Urethane Cap OP-090 M42A

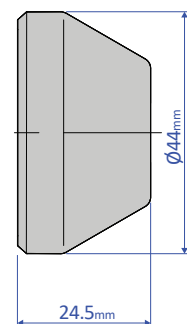

Mass 22g