

- Common Mode Choke / Line Filter
- UU10.5 Through Hole Design
- Horizontal Mount
- Extended Op. Temp. Range: -40°C to +130°C

Electrical Specifications @25°C				
Inductance N1 = N2	Test Frequency	DCR N1 = N2	Rated Current	Hi Pot VAC/5mA/60S
				Wdg-Wdg
370µH Min	1KHz, 1.0V	300mΩ Max	1.0A	2000

All specifications subject to change without notice.

MECHANICAL

Dimensions: $\frac{\text{inch}}{\text{(mm)}}$

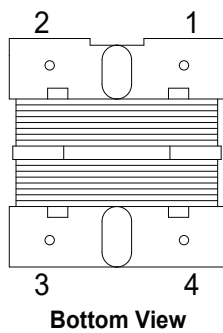
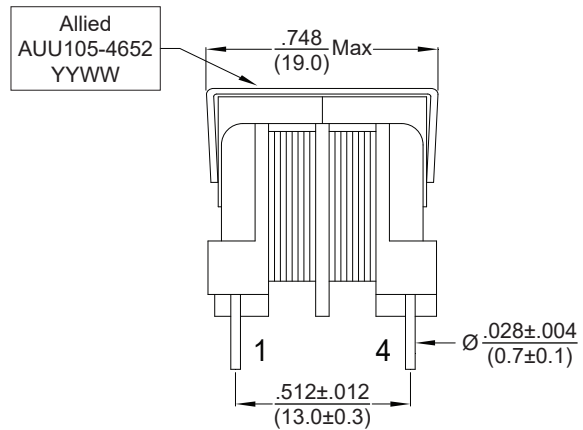
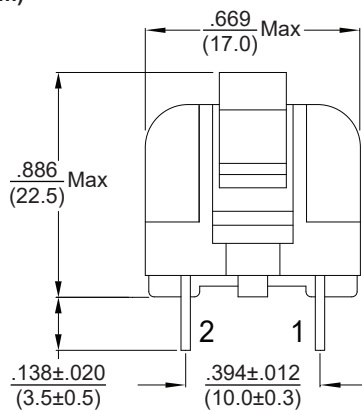

SCHEMATIC

