

1 2 3 4 5 6

A

B

C

D

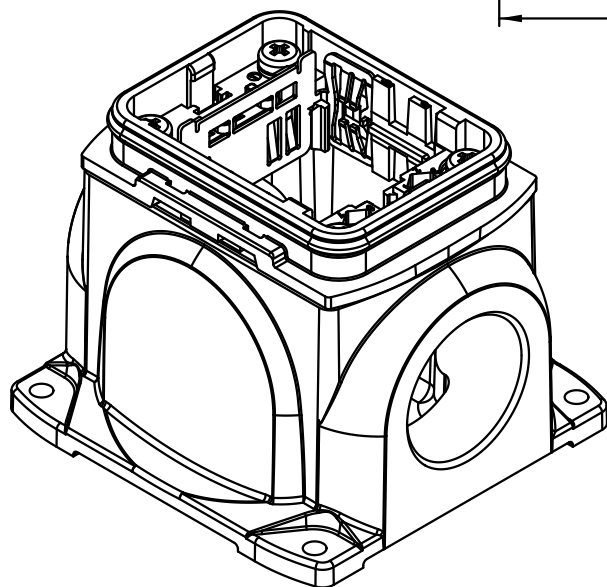
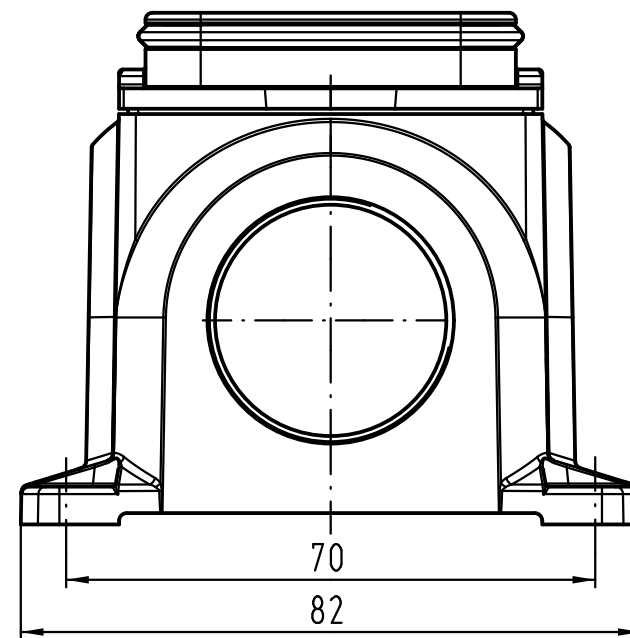
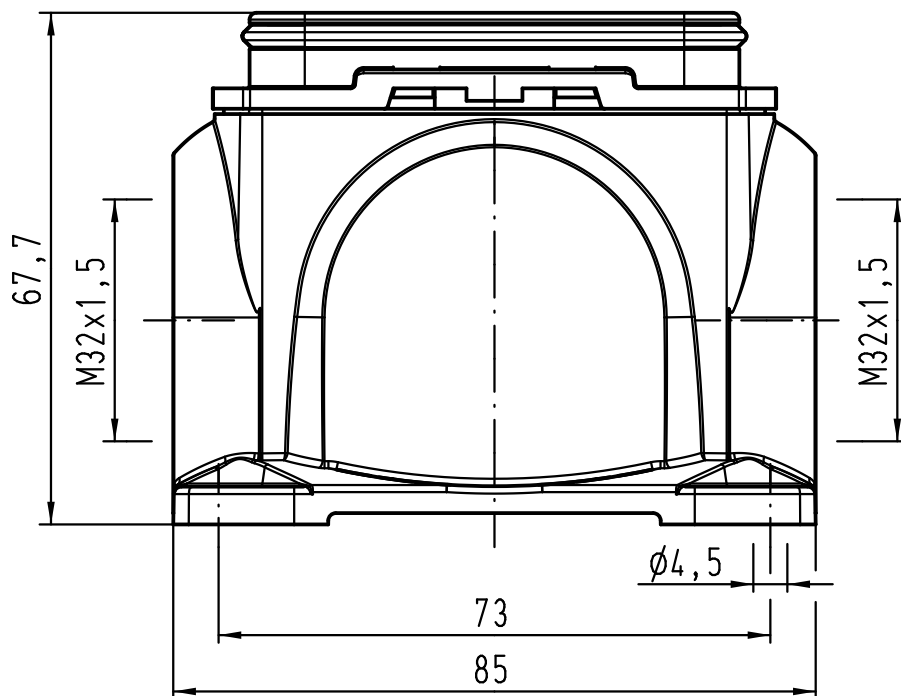

All Dimensions in mm Original Size DIN A 4		Techn. Character.			Nicht tolerierte Maße! Free size tolerances		
			Dat.	Name	Maßstab/ Scale 1:1	Han Yellock 30 Sockelgehäuse 2xM32 <i>housing surface mounting 2xM32</i>	
			Detail.	28.03.12			Ho
			Insp.				Bei
			Stand.				
A			HARTING Electric GmbH & Co. KG			TB 11 12 300 1216 Sub.	
Mod.	Dat.	Name	D-32339 Espelkamp				
						Blatt/ page	