

CHIP COIL (CHIP INDUCTORS) LQM18PZ□□□□CHD Specification Murata Standard Reference Specification 【AEC-Q200】

1.Scope

This reference specification applies to Chip coil (Chip Inductors) LQM18PZ_CH series for Automotive Electronics based on AEQ-Q200 except for Power train and Safety.

2. Part Numbering

(ex) $\frac{\text{LQ}}{\text{Product ID}} \frac{\text{M}}{\text{Structure}} \frac{\text{18}}{\text{Dimension (L} \times \text{W)}} \frac{\text{P}}{\text{Applications and Characteristics}} \frac{\text{Z}}{\text{Category}} \frac{\text{1R0}}{\text{Inductance}} \frac{\text{M}}{\text{Tolerance}} \frac{\text{C}}{\text{Dimension (T)}} \frac{\text{H}}{\text{Other}} \frac{\text{D}}{\text{Packaging D:Taping}}$

3. Rating

- Operating Temperature Range – 55°C to + 125°C
- Storage Temperature Range – 55°C to + 125°C

Customer Part Number	MURATA Part Number	Inductance		DC Resistance (Ω max.)	Self Resonant Frequency (MHz min.)	*3 Rated Current(mA)			ESD Rank 4 : < 8k
		(μH)	Tolerance			*1 (Based on Inductance change)	*2(Based on Temperature rise)		
							85°C	125°C	
	LQM18PZ1R0MCHD	1.0	±20%	0.29	80	600	950	650	4
	LQM18PZ2R2MCHD	2.2		0.48	50	200	750	500	
	LQM18PZ2R5NCHD	2.5		±30%	0.30	50	100	900	

*1: When rated current is applied to the products, Inductance will be within ±30% of initial Inductance value range.

*2: When rated current is applied to the products, temperature rise caused by self-generated heat shall be limited to 40°Cmax.

*3: As for the rated current marked with *3, rated current is derated as bellow figure depending on the operating temperature.

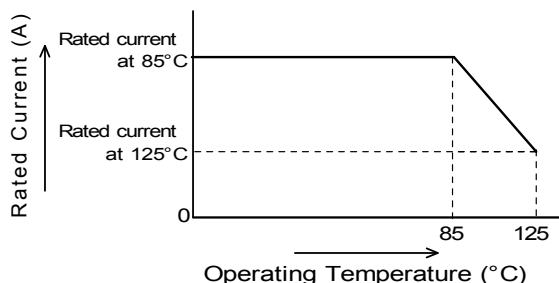

4. Testing Conditions

《Unless otherwise specified》

Temperature : Ordinary Temperature / 15°C to 35°C
 Humidity : Ordinary Humidity / 25%(RH) to 85%(RH)

《In case of doubt》

Temperature : 20°C ± 2°C
 Humidity : 60%(RH) to 70%(RH)
 Atmospheric Pressure : 86kPa to 106kPa

5. Appearance and Dimensions

0.4 ± 0.2

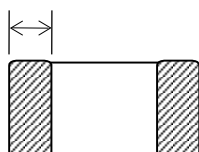

■ Unit Mass (Typical value)
0.004g

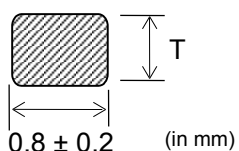
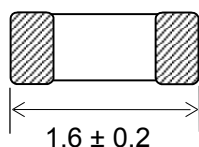

Dimension of T	Inductance: 1.0μH to 2.2μH	0.50mm±0.15mm
	Inductance: 2.5μH	0.45mm±0.15mm

6. Electrical Performance

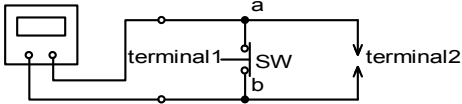
No.	Item	Specification	Test Method
6.1	Inductance	Inductance shall meet item 3.	Measuring Equipment: KEYSIGHT 4294A or equivalent (1mA) Measuring Frequency: 1MHz
6.2	DC Resistance	DC Resistance shall meet item 3.	Measuring Equipment: Digital multi meter Digital multi meter (TR6846 or equivalent)  (DC resistance shall be measured after putting chip coil between the terminal 2 under the condition of opening between a and b. Every measurement the terminal 1 shall be shorted between a and b when changing chip coil.)
6.3	Self Resonant Frequency (S.R.F)	S.R.F shall meet item 3.	Measuring Equipment: KEYSIGHT 4294A or equivalent

7. AEC-Q200 Requirement

7.1 Performance (based on Table 5 for Magnetics(Inductors / Transformer)

AEC-Q200 Rev.D issued June. 1 2010

AEC-Q200			Murata Specification / Deviation					
No	Stress	Test Method						
3	High Temperature Exposure	1000hours at 125 deg C Set for 24hours at room temperature, then measured. Unpowered.	Meet Table A after testing. Table A	<table border="1"> <tr> <td>Appearance</td> <td>No damage</td> </tr> <tr> <td>Inductance Change (at 1MHz)</td> <td>Within ±20%</td> </tr> </table>	Appearance	No damage	Inductance Change (at 1MHz)	Within ±20%
Appearance	No damage							
Inductance Change (at 1MHz)	Within ±20%							
4	Temperature Cycling	1000cycles -55 deg C to + 125deg C Set for 24hours at room temperature, then measured.	Meet Table A after testing.					
7	Biased Humidity	1000hours at 85 deg C, 85%RH	Meet Table B after testing. Table B	<table border="1"> <tr> <td>Appearance</td> <td>No damage</td> </tr> <tr> <td>Inductance Change (at 1MHz)</td> <td>Within ±50%</td> </tr> </table>	Appearance	No damage	Inductance Change (at 1MHz)	Within ±50%
Appearance	No damage							
Inductance Change (at 1MHz)	Within ±50%							
8	Operational Life	Apply 125 deg C 1000 hours Set for 24hours at room temperature, then measured	Meet Table B after testing.					
9	External Visual	Visual inspection	No abnormalities					
10	Physical Dimension	Meet ITEM 5 (Style and Dimensions)	No defects					
12	Resistance to Solvents	Per MIL-STD-202 Method 215	Not Applicable					
13	Mechanical Shock	Per MIL-STD-202 Method 213 Condition F: 1500g's/0.5ms/Half sine	Meet Table A after testing.					
14	Vibration	5g's for 20 minutes, 12cycles each of 3 orientations Test from 10-2000Hz. 12cycles each of 3 orientations	Meet Table A after testing.					
15	Resistance To Soldering Heat	No-heating Solder temperature 260C+/-5 deg C Immersion time 10s	Pre-heating : 150 to 180C / 90±30s Inductance : Within ±30% after testing.					
17	ESD	Per AEC-Q200-002	ESD Rank: Refer to Item 3 .Rating. No defects					

AEC-Q200			Murata Specification / Deviation
No	Stress	Test Method	
18	Solderability	Per J-STD-002	Method b : Not Applicable 95% of the terminations is to be soldered.
19	Electrical Characterization	Measured : Inductance	No defects
20	Flammability	Per UL-94	Not Applicable
21	Board Flex	Epoxy-PCB(1.6mm) Deflection 2mm(min) 60s minimum holding time	Meet Table A after testing.
22	Terminal Strength	Per AEC-Q200-006 A force of 17.7N for 60s	Murata deviation request: 10N for 60s No defect

8. Specification of Packaging

8.1 Appearance and Dimensions (8mm-wide paper tape)

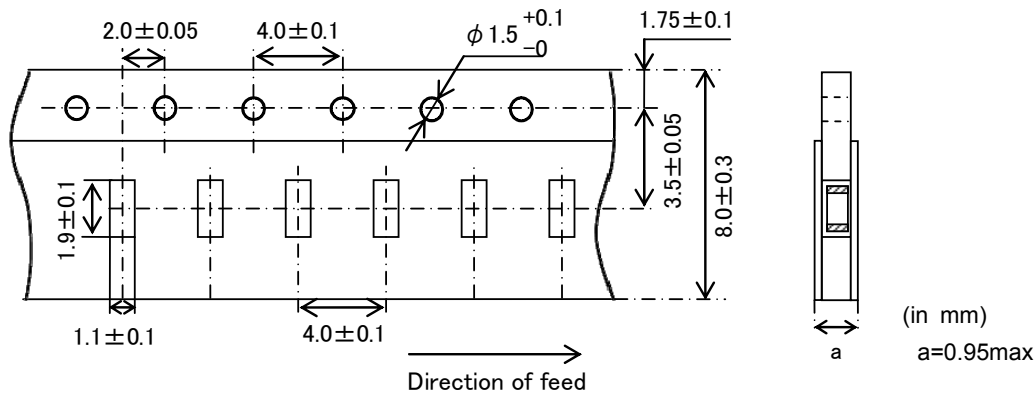

8.2 Specification of Taping

- (1) Packing quantity (standard quantity)
4,000 pcs. / reel
- (2) Packing Method
Products shall be packed in the cavity of the base tape and sealed by top tape and bottom tape.
- (3) Sprocket hole
The sprocket holes are to the right as the tape is pulled toward the user.
- (4) Spliced point
Base tape and Top tape has no spliced point.
- (5) Missing components number
Missing components number within 0.1% of the number per reel or 1 pc., whichever is greater, and are not continuous. The specified quantity per reel is kept.

8.3 Pull Strength

Top tape	5N min.
Bottom tape	

8.4 Peeling off force of top tape

Speed of Peeling off	300mm/ min
Peeling off force	0.1 to 0.6N (minimum value is typical)

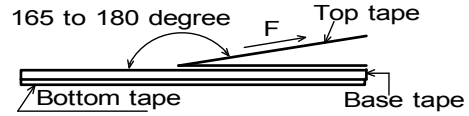

8.5 Dimensions of Leader-tape, Trailer and Reel

There shall be leader-tape (top tape and empty tape) and trailer-tape (empty tape) as follows.

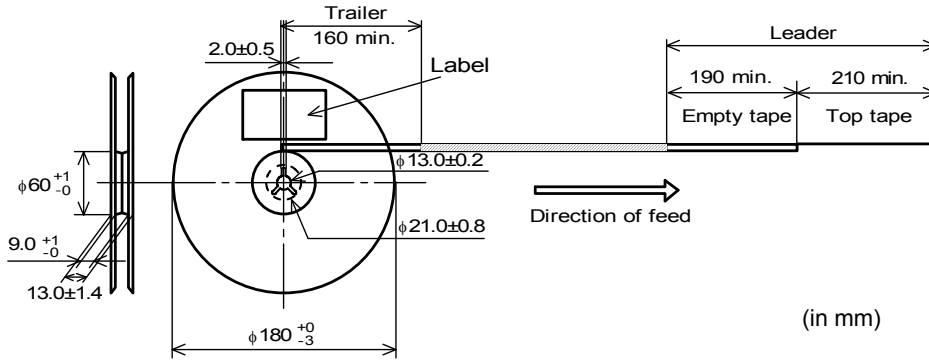

8.6 Marking for reel

Customer part number, MURATA part number, Inspection number (*1), RoHS Marking (*2), Quantity etc ...

*1) <Expression of Inspection No.>

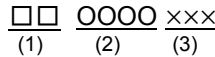

- (1) Factory Code
- (2) Date First digit : Year / Last digit of year
 Second digit : Month / Jan. to Sep. → 1 to 9, Oct. to Dec. → O, N, D
 Third, Fourth digit : Day
- (3) Serial No.

*2) <Expression of RoHS Marking >

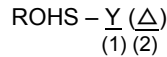

- (1) RoHS regulation conformity parts.
- (2) MURATA classification number

8.7 Marking for Outside package (corrugated paper box)

Customer name, Purchasing order number, Customer part number, MURATA part number, RoHS Marking (*2), Quantity, etc ...

8.8. Specification of Outer Case

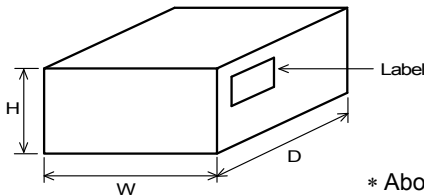

Outer Case Dimensions (mm)			Standard Reel Quantity in Outer Case (Reel)
W	D	H	
186	186	93	5

* Above Outer Case size is typical. It depends on a quantity of an order.

9. ⚠ Caution

9.1 Limitation of Applications

Please contact us before using our products for the applications listed below which require especially high reliability for the prevention of defects which might directly cause damage to the third party's life, body or property.

- | | |
|-----------------------------------|--|
| (1) Aircraft equipment | (6) Transportation equipment (trains, ships, etc.) |
| (2) Aerospace equipment | (7) Traffic signal equipment |
| (3) Undersea equipment | (8) Disaster prevention / crime prevention equipment |
| (4) Power plant control equipment | (9) Data-processing equipment |
| (5) Medical equipment | (10) Applications of similar complexity and /or reliability requirements to the applications listed in the above |

9.2 Caution(Rating)

Do not exceed maximum rated current of the product. Thermal stress may be transmitted to the product and short/open circuit of the product or falling off the product may be occurred.

9.3 Fail-safe

Be sure to provide an appropriate fail-safe function on your product to prevent a second damage that may be caused by the abnormal function or the failure of our product.

10. Notice

This product is designed for solder mounting.

Please consult us in advance for applying other mounting method such as conductive adhesive.

Cracks may occur at the connection of solder (solder fillet portion) due to the difference of the coefficient of thermal expansion from a mounting board when heat stress like heat cycle, etc. are repeatedly given to them.

The occurrence of the crack by heat stress may be influenced by the size of a pad, solder volume, heat radiation of mounting board etc., so please pay careful attention to designing when a big change in ambient temperature can be assumed.

10.1 Land pattern designing

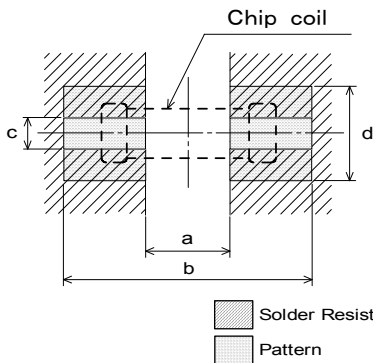

Operating Current (A)	a	b	c	Land pad thickness and dimension d		
				18μm	35μm	70μm
0 to 0.7	0.7	1.8 to 2.0	0.7	0.7	0.7	0.7
0.7 to 1.05				1.1	0.7	0.7

(in mm)

10.2 Flux, Solder

- Use rosin-based flux.
 - Don't use highly acidic flux with halide content exceeding 0.2(wt)% (chlorine conversion value).
 - Don't use water-soluble flux.
- Use Sn-3.0Ag-0.5Cu solder.
- Standard thickness of solder paste: 100 μm to 150 μm.

10.3 Reflow soldering conditions

- Products can be applied to reflow soldering.
- Pre-heating should be in such a way that the temperature difference between solder and product surface is limited to 150°C max. Cooling into solvent after soldering also should be in such a way that the temperature difference is limited to 100°C max.
Insufficient pre-heating may cause cracks on the product, resulting in the deterioration of products quality.
- Standard soldering profile and the limit soldering profile is as follows.
The excessive limit soldering conditions may cause leaching of the electrode and/or resulting in the deterioration of product quality.

Reflow soldering profile

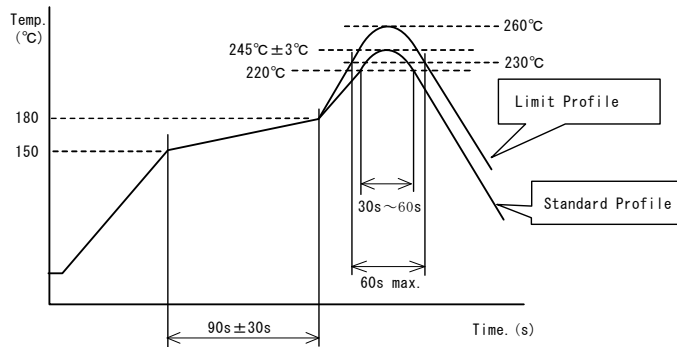

	Standard Profile	Limit Profile
Pre-heating	150°C~180°C, 90s±30s	
Heating	above 220°C, 30s~60s	above 230°C, 60s max.
Peak temperature	245°C±3°C	260°C, 10s
Cycle of reflow	2 times	2 times

10.4 Reworking with soldering iron

The following conditions must be strictly followed when using a soldering iron.

Pre-heating	150°C, 1 min
Tip temperature	350°C max.
Soldering iron output	80W max.
Tip diameter	φ3mm max.
Soldering time	3(+1, -0)s
Time	2 times

Note : Do not directly touch the products with the tip of the soldering iron in order to prevent the crack on the products due to the thermal shock.

10.5 Solder Volume

- Solder shall be used not to be exceeded the upper limits as shown below.
- Accordingly increasing the solder volume, the mechanical stress to Chip is also increased.
Exceeding solder volume may cause the failure of mechanical or electrical performance.

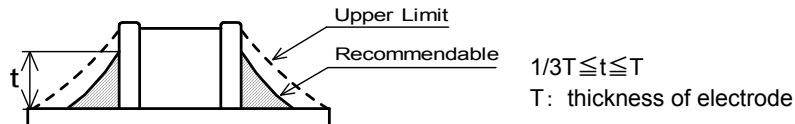

10.6 Product's location

The following shall be considered when designing and laying out P.C.B.'s.

(1) P.C.B. shall be designed so that products are not subject to the mechanical stress due to warping the board.

[Products direction]

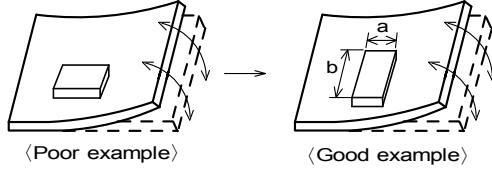

Products shall be located in the sideways direction (Length: a:b) to the mechanical stress.

(2) Components location on P.C.B. separation.

It is effective to implement the following measures, to reduce stress in separating the board.

It is best to implement all of the following three measures; however, implement as many measures as possible to reduce stress.

Contents of Measures	Stress Level
(1) Turn the mounting direction of the component parallel to the board separation surface.	A > D *1
(2) Add slits in the board separation part.	A > B
(3) Keep the mounting position of the component away from the board separation surface.	A > C

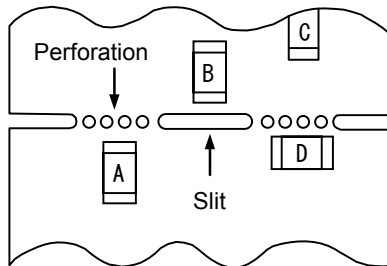

*1 A > D is valid when stress is added vertically to the perforation as with Hand Separation. If a Cutting Disc is used, stress will be diagonal to the PCB, therefore A > D is invalid.

(3) Mounting Components Near Screw Holes

When a component is mounted near a screw hole, it may be affected by the board deflection that occurs during the tightening of the screw. Mount the component in a position as far away from the screw holes as possible.

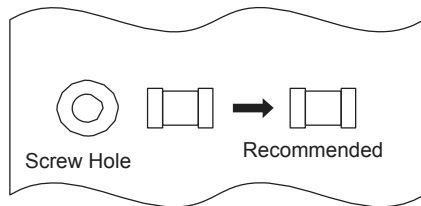

10.7 Cleaning Conditions

Products shall be cleaned on the following conditions.

- (1) Cleaning temperature shall be limited to 60°C max. (40°C max for IPA.)
- (2) Ultrasonic cleaning shall comply with the following conditions with avoiding the resonance phenomenon at the mounted products and P.C.B.
Power : 20 W / l max. Frequency : 28kHz to 40kHz Time : 5 min max.
- (3) Cleaner
 1. Alcohol type cleaner
Isopropyl alcohol (IPA)
 2. Aqueous agent
PINE ALPHA ST-100S
- (4) There shall be no residual flux and residual cleaner after cleaning. In the case of using aqueous agent, products shall be dried completely after rinse with de-ionized water in order to remove the cleaner.
- (5) Other cleaning Please contact us.

10.8 Resin coating

The inductance value may change and/or it may affect on the product's performance due to high cure-stress of resin to be used for coating/molding products. So please pay your careful attention when you select resin.

In prior to use, please make the reliability evaluation with the product mounted in your application set.

10.9 Caution for use

There is possibility that the inductance value change due to magnetism. Don't use a magnet or a pair of tweezers with magnetism when chip coil are handled. (The tip of the tweezers should be molded with resin or pottery.)

10.10 Magnetic Saturation

When the excessive current over rated current is applied, the inductance value may change due to magnetism.

10.11 Handling of a substrate

After mounting products on a substrate, do not apply any stress to the product caused by bending or twisting to the substrate when cropping the substrate, inserting and removing a connector from the substrate or tightening screw to the substrate.

Excessive mechanical stress may cause cracking in the product.

Bending

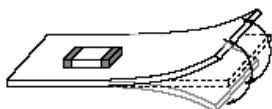

Twisting

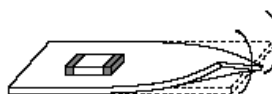

10.12 Storage and Handling Requirements

(1) Storage period

Use the products within 6 months after delivered.
Solderability should be checked if this period is exceeded.

(2) Storage conditions

•Products should be stored in the warehouse on the following conditions.

Temperature : -10°C to 40°C

Humidity : 15% to 85% relative humidity No rapid change on temperature and humidity

Don't keep products in corrosive gases such as sulfur, chlorine gas or acid, or it may cause oxidization of electrode, resulting in poor solderability.

•Products should be stored on the palette for the prevention of the influence from humidity, dust and so on.

•Products should be stored in the warehouse without heat shock, vibration, direct sunlight and so on.

•Products should be stored under the airtight packaged condition.

(3) Handling Condition

Care should be taken when transporting or handling product to avoid excessive vibration or mechanical shock.

11.  Note

(1) Please make sure that your product has been evaluated in view of your specifications with our product being mounted to your product.

(2) You are requested not to use our product deviating from the reference specifications.

(3) The contents of this reference specification are subject to change without advance notice.

Please approve our product specifications or transact the approval sheet for product specifications before ordering.