

CODINGS

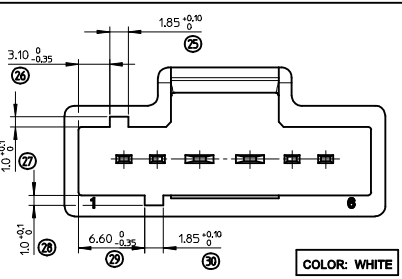

OVERALL DIMENSIONS

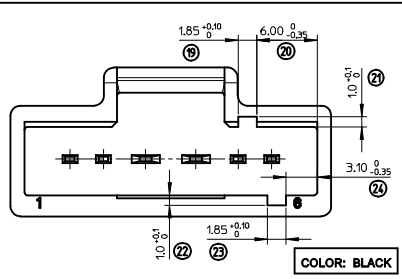
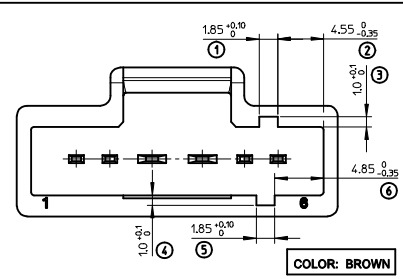
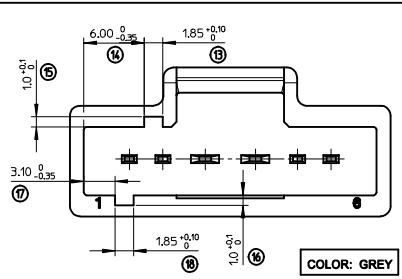
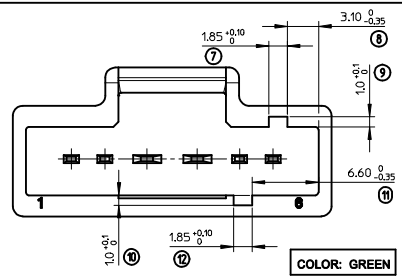
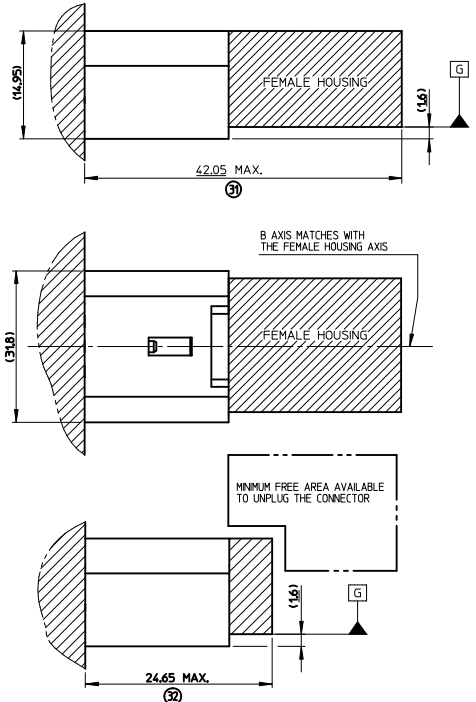

HEADER'S DEFINITION
(GREEN CODING REPRESENTED)

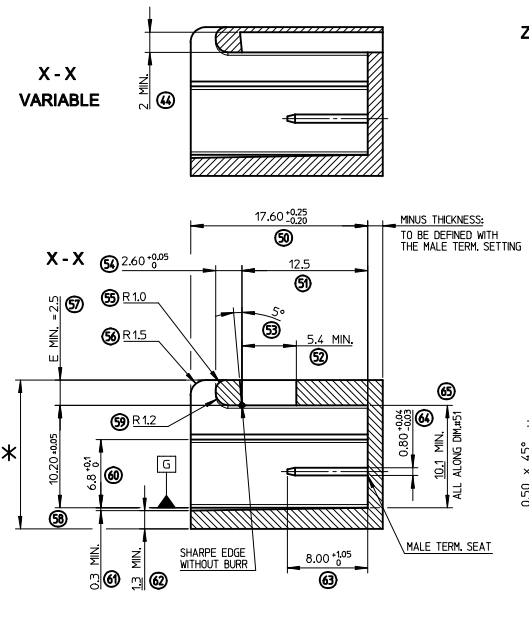

ISO VIEW
(GREEN CODING)

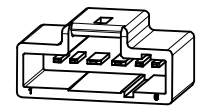

NOTES:

- MALE TERMINALS:**
 - MALE TERMINALS RESISTANCE: 100N MIN IN MALE TERM. AXIS.
 - MATERIAL: COPPER, COPPER ALLOY OR BRASS.
 - FINISHES: TIN PLATED 2µ MIN.
- HEADER:**
 - RADII WITHOUT DIM: R=0.3MM
 - E MIN: MINIMUM MATERIAL THICKNESS RECOMMENDED FOR SPECIFIED MATERIAL
 - MATERIAL: PBT (RECOMMENDED) (70)
 - * WARNING: 0.35MM MAX. ACCEPTED ON "*" DIM. WITH ANOTHER EXTERNAL SHAPE AS DRAWN WHEN PLUGGED.
- MATES WITH:**
 - MOLEX CONNECTORS 98821-106X

MALE TERMINALS SETTING

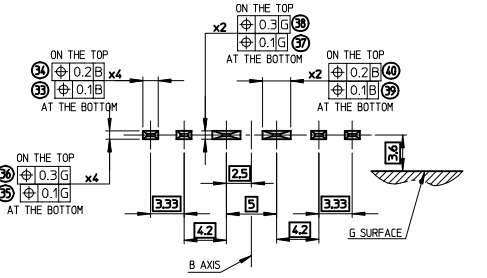

MALE TERMINALS VARIABLE SETTING

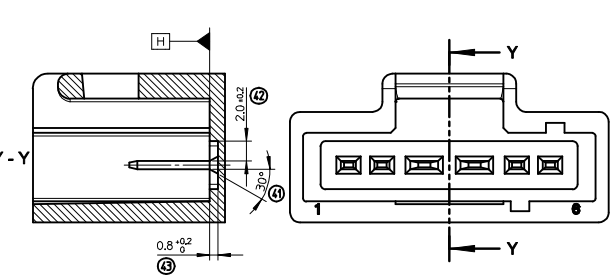

REV.	FIRST	LAST	DELETED	SUPERSEDED
A	1	76		

INSPECTION NUMBERS

PRINT 1st RELEASE
EC NO: G2012-0184
DRAWING NUMBER: 2012/04/23
CHKD: JUDUCLOS 2012/04/24
APPROVED: JUDUCLOS 2012/05/02

QUALITY SYMBOLS	GENERAL TOLERANCES (UNLESS SPECIFIED)
▽+0	4 PLACES ± --- ± ---
▽+0	3 PLACES ± --- ± ---
▽+0	2 PLACES ± 0.1 ± ---
▽+0	1 PLACE ± 0.1 ± ---
▽+0	0 PLACE ± --- ± ---
	ANGULAR ± 2°

DRAFT WHERE APPLICABLE MUST REMAIN WITHIN DIMENSIONS

DIMENSION STYLE: MM ONLY
SCALE: 4:1
DESIGN UNITS: METRIC
FIRST ANGLE PROJECTION

6W INTERFACE HYB.
(FOR FEMALE HOUSING)

molex

DOCUMENT NO. SD-98820-002
SHEET NO. 1 OF 1

THIS DRAWING CONTAINS INFORMATION THAT IS PROPRIETARY TO MOLEX INCORPORATED AND SHOULD NOT BE USED WITHOUT WRITTEN PERMISSION

REV.	MODIFICATIONS
E	- PRINT REDRAWN AND ASSOCIATED WITH 3D MODELS. - FRENCH TEXTS REMOVED. - RE-NUMBERED BALLONS. - NEW MOLEX TITLE BLOCK (+ RE-PAGED).
D1	- DRAWING SPEC. N°26 REDRAWN WITH MOLEX ID ISO-98820-002
D	- R12 ±0.1 WAS R0.5 ±0.10 TO BE RESPECTED ON HEADERS.
C	- BROWN CODING ADDED.
B	- E-E SECTION: 0.3 MIN. (AND DRAFT) WAS 0.3 0/-0.1 MALE TERMINALS TOLERANCES AND SETTING UPDATED.
A	- 29.1 ±0.10 → 29.1 ±0.1/-0.05 - 7 0/-0.1 → 7 MAX. - DM: 0.1 MIN. ADDED ALL ALONG DIM. 12.5 - 3.1 0/-0.1 → 3.1 0/-0.35 - 6.6 0/-0.1 → 6.6 0/-0.35 - 6.1 0/-0.1 → 6.1 0/-0.35
/	- DRAWING GENERATED WITH SPEC. N°27 REV. B WITH CODINGS UPDATED AND LIGHTNESS CAVITIES REMOVED.

MOLEX P/N°: 0988211060
COLOUR: WHITE

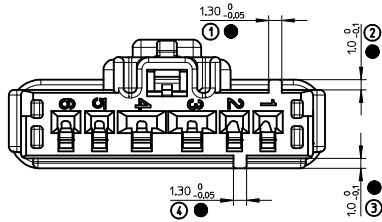

MOLEX P/N°: 0988211061
COLOUR: BLACK

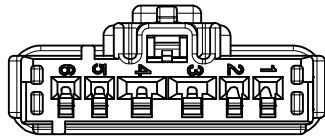

MOLEX P/N°: 0988211065
COLOUR: GREEN

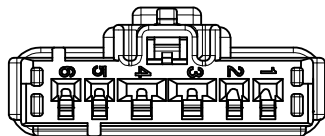

MOLEX P/N°: 0988211068
COLOUR: GREY

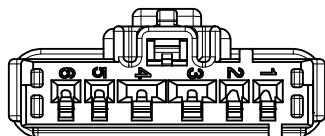

MOLEX P/N°: 0988211069
COLOUR: BROWN

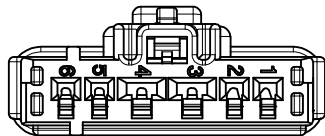

CAVITIES PITCH
5:1

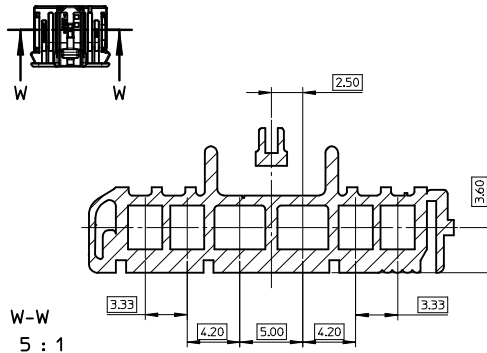

HOLDING IN FIXTURE
DIMENSION PRIOR TO LOCKING
2:1

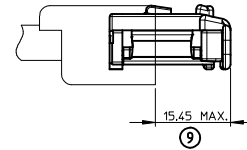

DIMENSION WHEN CONNECTOR MATED
2:1

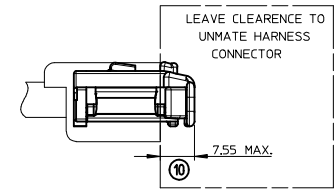

CLEARANCE FOR CONNECTOR MATED AND UNMATED
2:1

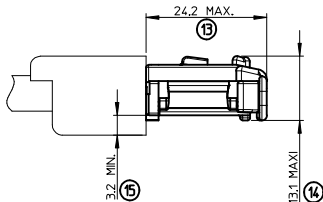
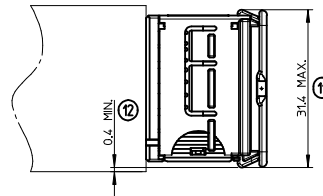

HOLDING IN FIXTURE
2:1

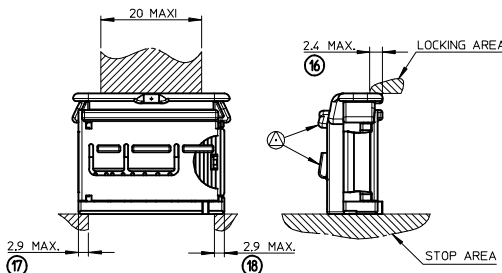

		MOLEX P/N	
SCC RCPT TERM 1.5 MM	RANGE 1	0988971109	
	RANGE 2	0988971119	
	RANGE 3	0988971129	
TERM RCPT 2.8 MM UCC2	RANGE 1		0988981029
	RANGE 2		0988981039
	RANGE 3		0988981049

INDICATION DIMENSIONS S.P.C DENOTES S.P.C DIMENSIONS
 INDICATION DIMENSIONS CRITIQUES DENOTES CRITIQUES DIMENSIONS
 INDICATION DIMENSIONS FONCTIONNELLES DENOTES FUNCTIONNELLES DIMENSIONS
 QUANTITE PAR FEUILLE INDIVIDUELLE
 QUANTITY PER INDIVIDUAL SHEET
 = 0 = 0 = 4

- FEMALE CONNECTOR WILL MATE WITH MALE CONNECTOR P/N 098825106x OR HEADER P/N 098770201X

- THE USING CONDITIONS OF THE HINGE ARE SHOWN IN THE MOLEX SPECIFICATION N°: AS-98821-001.

- HOLDING FORCE ONTO FIXTURE:
20 TO 35 NEWTON WITH PUSH TEST.
10 TO 35 NEWTON WITHOUT PUSH TEST.

- DO NOT LOCK THE FIXTURE WITH THE AREAS IDENTIFIED BY: (16)

- DO NOT DAMAGE THE PART ON THE AREAS IDENTIFIED BY: (17)

- FEMALE TERMINAL USED: SEE CHART BELOW.

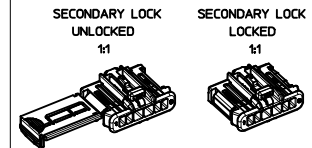

REVISED IEC NO: G2013-030 0000-0103 C DRAWING: G2013-030 CHYKOLBARRETO 2013/04/26 APPR: OPFLLESSIS 2013/09/12	QUALITY SYMBOLS (19) (20) (21)	GENERAL TOLERANCES (UNLESS SPECIFIED)		DIMENSION STYLE MM ONLY		SCALE 4:1	DESIGN UNITS METRIC	FIRST ANGLE PROJECTION	
			mm	INCH	DRAWN BY LPOUCHAUD	DATE 2007/12/05	TITLE UCC RCPT CONN HYBRID UNSEALD 6CKT		
		4 PLACES ± --- ± ---			CHECKED BY YIGEL	DATE 2007/12/12	moxex DOCUMENT NO. SD-98821-002 SHEET NO. 1 OF 2		
		3 PLACES ± --- ± ---			APPROVED BY LSTICKEIR	DATE 2007/12/17			
ANGULAR ± 1 ° DRAFT WHERE APPLICABLE MUST REMAIN WITHIN DIMENSIONS		SEE CHART SIZE 1		THIS DRAWING CONTAINS INFORMATION THAT IS PROPRIETARY TO MOLEX INCORPORATED AND SHOULD NOT BE USED WITHOUT WRITTEN PERMISSION					

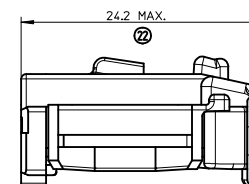
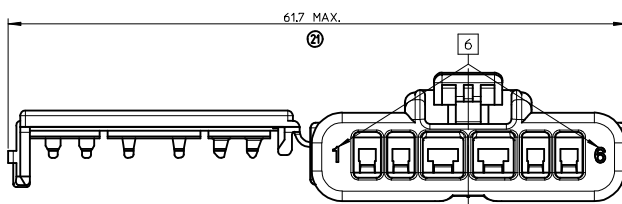
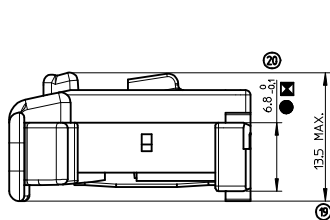

SECONDARY LOCK
UNLOCKED

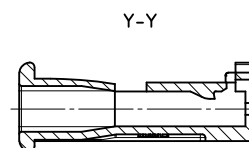
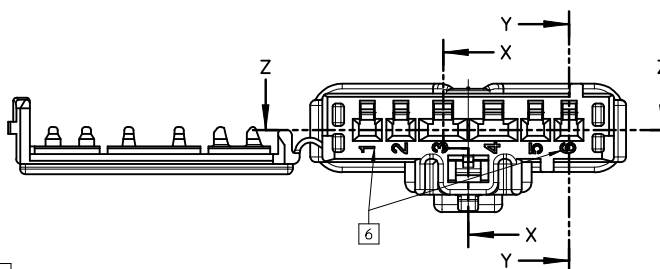
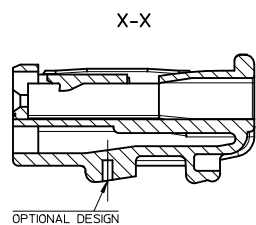
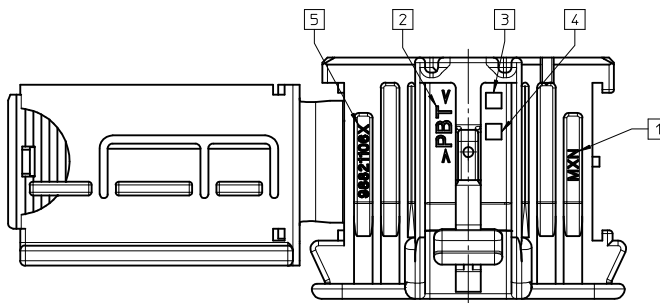

SECONDARY LOCK
LOCKED

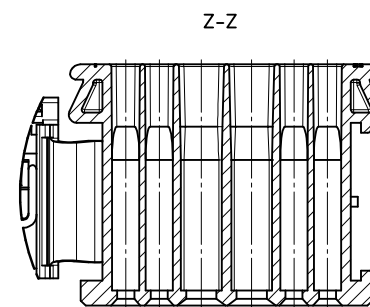
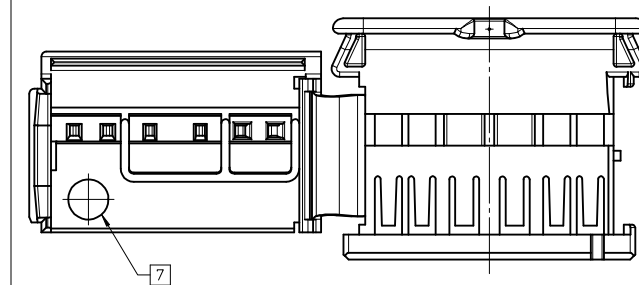
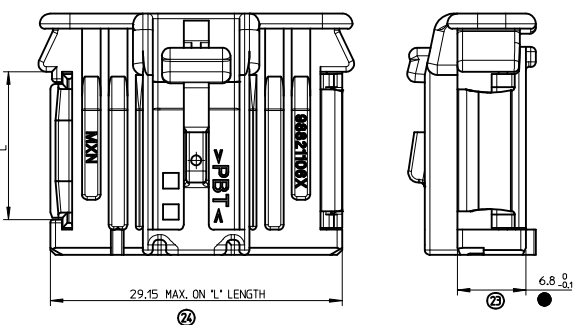

- FEMALE CONTACTS AND CAVITIES LOCATION,
HOLDING IN FIXTURE, OVERALL DIMENSIONS,
KEY ACCORDING SHEET 1/2 OF SAME P/N°.

MARKINGS:

- 1 - SUPPLIER MFG. PLANT ID.
- 2 - MATERIAL
- 3 - MOLD CAVITY ID.
- 4 - SUPPLIER MOLD REV. LEVEL
- 5 - SUPPLIER P/N°
- 6 - TERM. CAVITY N°
- 7 - DATUM: MONTH/YEAR

1 : 1



[X] INDICATION DIMENSIONS S.P.C
 DENOTES S.P.C DIMENSIONS
 [O] INDICATION DIMENSIONS CRITIQUES
 DENOTES CRITIQUES DIMENSIONS
 [●] INDICATION DIMENSIONS FONCTIONNELLES
 DENOTES FUNCTIONNELLES DIMENSIONS
 QUANTITE PAR FEUILLE INDIVIDUELLE
 QUANTITY PER INDIVIDUAL SHEET
 [X] = 1 [O] = 0 [●] = 2

DESCRIPTION	P/N°	COLOUR	MATERIAL	EFFECTIVE WEIGHT
UCC RCPT CONN HYBRID UNSEALED 6CKT	0988211069	BROWN	PBT	3.480 g
	0988211068	GREY		
	0988211065	GREEN		
	0988211060	WHITE		
	0988211061	BLACK		

REVISED
 E.C. NO: G2013-0330
 DRAWING: BRUNIERES 2013/04/26
 CHK: BARRETO 2013/04/26
 APPR: DESSIS 2013/09/12

QUALITY SYMBOLS	GENERAL TOLERANCES (UNLESS SPECIFIED)	
	mm	INCH
▽=0	4 PLACES ± --- ± ---	
▽=0.05	3 PLACES ± --- ± ---	
▽=0.10	2 PLACES ± 0.05 ± ---	
▽=0.15	1 PLACE ± 0.10 ± ---	
▽=0.20	0 PLACE ± 0.10 ± ---	
	ANGULAR ± 1 °	
	DRAFT WHERE APPLICABLE MUST REMAIN WITHIN DIMENSIONS	

DIMENSION STYLE	
MM ONLY	
DRAWN BY	DATE
LPOUCHAUD	2007/12/05
CHECKED BY	DATE
YIGEL	2007/12/12
APPROVED BY	DATE
LSTICKEIR	2007/12/17
MATERIAL NO.	
SEE CHART	
THIS DRAWING CONTAINS INFORMATION THAT IS PROPRIETARY TO MOLEX INCORPORATED AND SHOULD NOT BE USED WITHOUT WRITTEN PERMISSION	

SCALE	DESIGN UNITS	FIRST ANGLE PROJECTION	TITLE
4:1	METRIC	[Symbol]	UCC RCPT CONN HYBRID UNSEALED 6CKT
DOCUMENT NO.			SHEET NO.
SD-98821-002			2 OF 2
molex			