

Photologic® Slotted Optical Switch

OPB930 and OPB940 (L and W Series)



Features:

- Choice of aperture size
- Choice of output configurations
- Choice of opaque or IR transmissive shell
- Choice of pins (L) or wires (W)
- 0.125" (3.18 mm) slot width
- 0.320" (8.128 mm) lead spacing for PCBoard (side mounting)
- Data rates to 250 kBaud

Description:

The **OPB930** and **OPB940** series of Photologic® photo integrated circuit switches provide optimum flexibility for the design engineer. Building from a standard housing with a 0.125" (3.18 mm) wide slot, a user can specify the type and polarity of TTL output, discrete shell material, aperture width and either 0.350" (8.9 mm) long pins (**L Series**) or 24" (610 mm) AWG, UL listed wire leads (**W Series**).

All housings are made from an opaque grade of injection-molded plastic that minimizes the assembly's sensitivity to both visible and near-infrared ambient radiation. Discrete shells (exposed on the parallel faces inside the device throat) are either IR transmissive plastic (for applications where aperture contamination may occur) or opaque plastic (for maximum protection against ambient light).

Electrical output can be specified as either TTL Totem Pole or TTL Open Collector, either of which can be supplied with buffer or inverter output polarity. All devices have the added stability of a built-in hysteresis amplifier.

Custom electrical, wire and cabling and connectors are available. Contact your local representative or OPTEK for more information.

Applications:

- Mechanical switch replacement
- Speed indication (tachometer)
- Mechanical limit indication

Part Number Guide — OPB930 and OPB940 Series

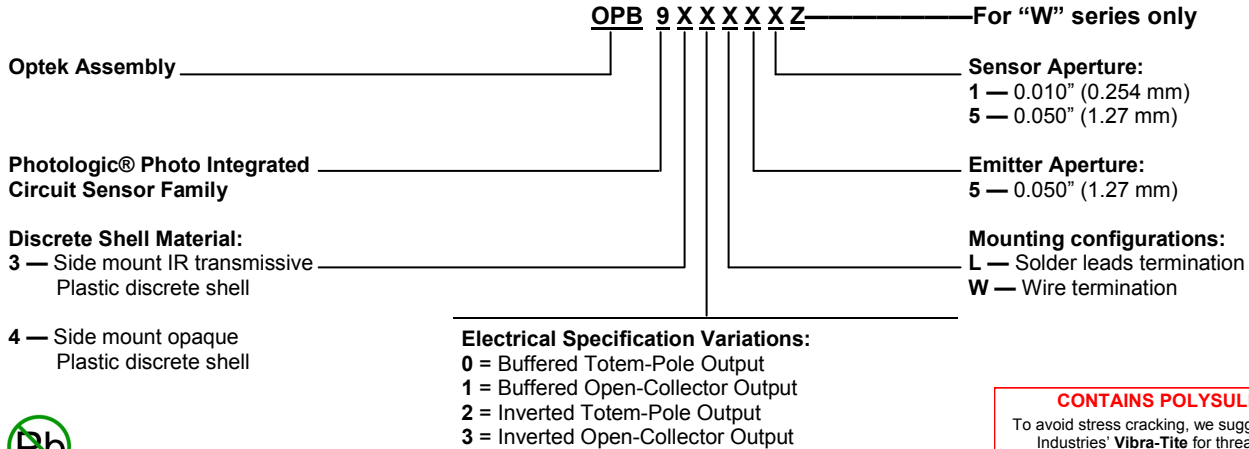

CONTAINS POLYSULFONE

To avoid stress cracking, we suggest using ND Industries' **Vibra-Tite** for thread-locking. **Vibra-Tite** evaporates fast without causing structural failure in OPTEK's molded plastics.

General Note
TT Electronics reserves the right to make changes in product specification without notice or liability. All information is subject to TT Electronics' own data and is considered accurate at time of going to print.

OPTEK Technology, Inc.
1645 Wallace Drive, Carrollton, TX 75006 | Ph: +1 972 323 2200
www.optekinc.com | www.ttelectronics.com

Photologic® Slotted Optical Switch



OPB930, OPB940 Buffered Totem-Pole

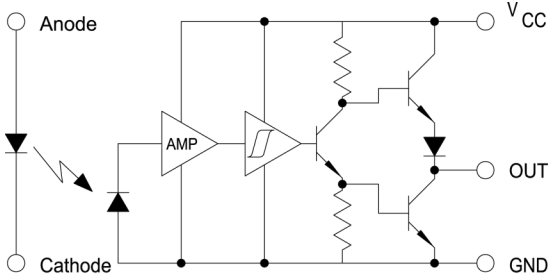

OPB931, OPB941 Buffered Open-Collector

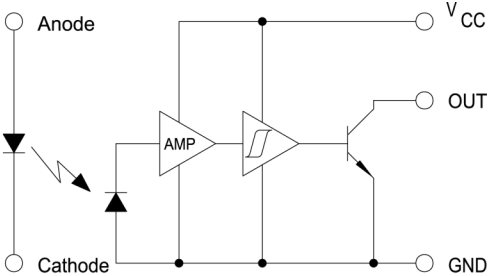

OPB932, OPB942 Inverted Totem-Pole

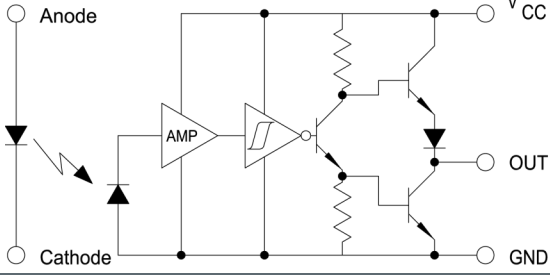

OPB933 & OPB943 Inverted Open-Collector

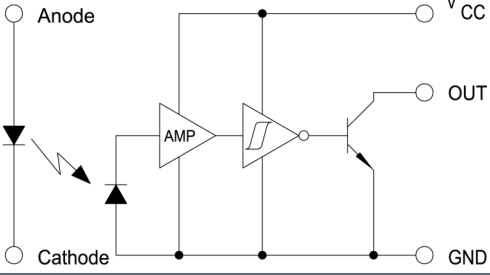

Absolute Maximum Ratings ($T_A = 25^\circ\text{C}$ unless otherwise noted)	
Supply Voltage, V_{CC} (not to exceed 3 seconds)	10 V
Operating Temperature Range	-40°C to $+70^\circ\text{C}$
Storage Temperature Range	-40°C to $+85^\circ\text{C}$
Lead Soldering Temperature (1/16 inch (1.6mm) from the case for 5 sec. with soldering iron ⁽¹⁾)	260° C
Input Infrared LED	
Input Diode Power Dissipation ⁽²⁾	100 mW
Output Photologic® Power Dissipation ⁽³⁾	200 mW
Total Device Power Dissipation ⁽⁴⁾	300 mW
Output Photologic®	
Voltage at Output Lead (Open Collector Output)	35 V
Diode Forward DC Current	40 mA
Diode Reverse DC Voltage	2 V

- Notes:
- (1) RMA flux is recommended. Duration can be extended to 10 seconds maximum when flow soldering.
 - (2) Derate linearly 2.22 mW/°C above 25°.
 - (3) Derate linearly 4.44 mW/°C above 25°.
 - (4) Derate linearly 6.66 mW/°C above 25°.
 - (5) OPB930L/OPB940L series devices are terminated with 0.020" square leads designed for PCBoard mounting.
 - (6) Methanol and isopropanol are recommended as cleaning agents. Plastic housing is soluble in chlorinated hydrocarbons and ketones.
 - (7) All parameters tested using pulse technique.

General Note
 TT Electronics reserves the right to make changes in product specification without notice or liability. All information is subject to TT Electronics' own data and is considered accurate at time of going to print.

OPTEK Technology, Inc.
 1645 Wallace Drive, Carrollton, TX 75006 | Ph: +1 972 323 2200
 www.optekinc.com | www.ttelectronics.com

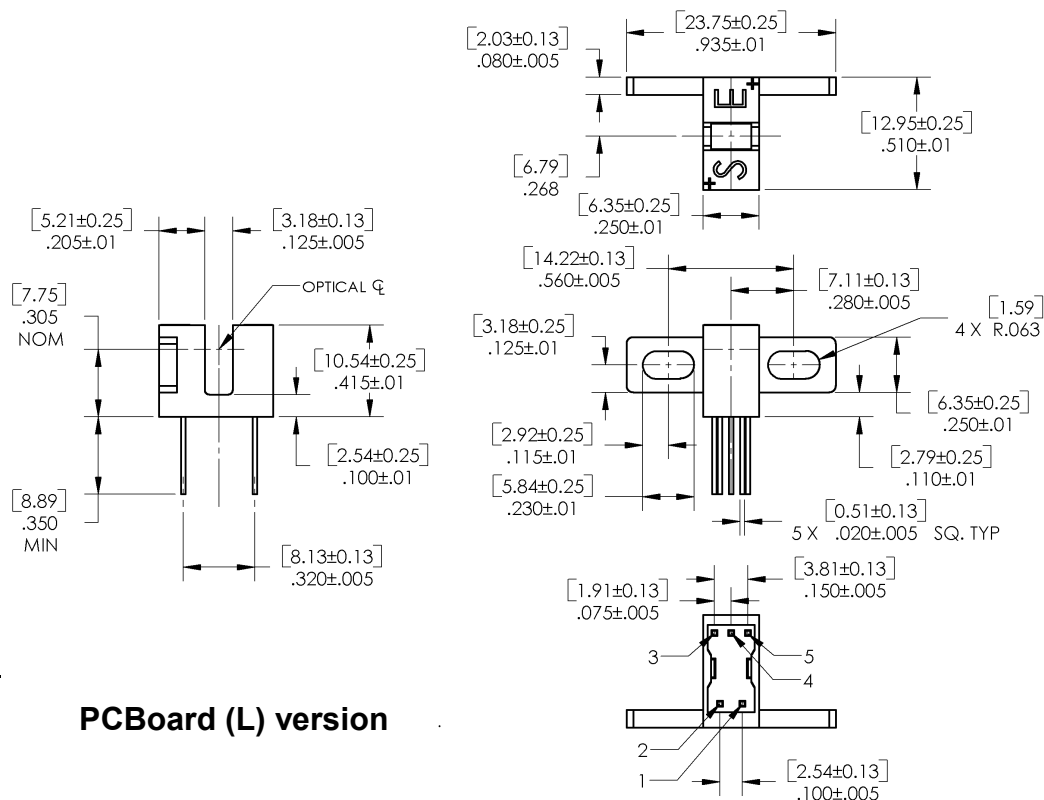

PCBoard (L) version

Color- Pin #	Description
Red—1	Anode
Black—2	Cathode
White—3	V _{CC}
Blue—4	Output
Green—5	Ground

DIMENSIONS ARE IN: [MILLIMETERS]
[INCHES]

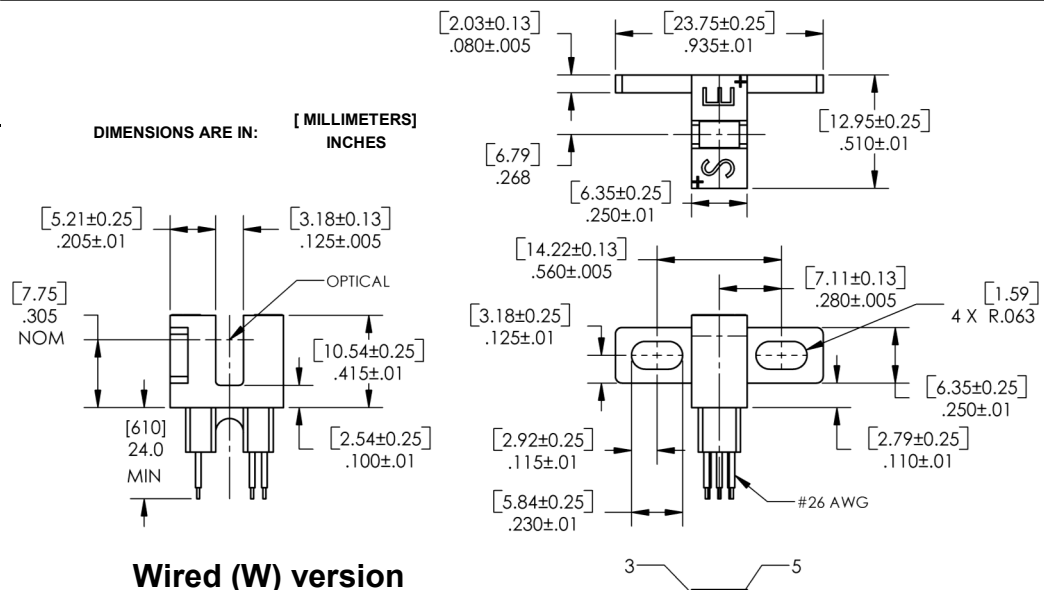

Wired (W) version

The W Series includes wire terminations of 24" (610 mm) 7-strand, 26 AWG UL insulated wire on each terminal. Each device incorporates a wire strain relief at the housing surface. The insulation functions and colors are: anode (red), cathode (black), phototransistor collector (white) and phototransistor emitter (green).

General Note
TT Electronics reserves the right to make changes in product specification without notice or liability. All information is subject to TT Electronics' own data and is considered accurate at time of going to print.

OPTEK Technology, Inc.
1645 Wallace Drive, Carrollton, TX 75006 | Ph: +1 972 323 2200
www.optekinc.com | www.ttelectronics.com

Electrical Characteristics ($T_A = 25^\circ \text{C}$ unless otherwise noted)

SYMBOL	PARAMETER	MIN	TYP	MAX	UNITS	TEST CONDITIONS
Input Diode						
V_F	Forward Voltage	-	-	1.7	V	$I_F = 20 \text{ mA}$
I_R	Reverse Current	-	-	100	μA	$V_R = 2.0 \text{ V}$
Output Photologic® Sensor						
V_{CC}	Operating D.C. Supply Voltage	4.75	-	5.25	V	-
I_{CCL}	Low Level Supply Current: Totem Pole & Open-Collector	-	-	15	mA	$V_{CC} = 5.25, I_F = 0 \text{ mA}^{(1)}$
	Inverted Totem-Pole & Inverted Open-Collector	-	-	15	mA	$V_{CC} = 5.25, I_F = 15 \text{ mA}$
I_{CCH}	High Level Supply Current: Totem Pole & Open-Collector	-	-	15	mA	$V_{CC} = 5.25, I_F = 15 \text{ mA}$
	Inverted Totem-Pole & Inverted Open-Collector	-	-	15	mA	$V_{CC} = 5.25, I_F = 0 \text{ mA}^{(1)}$
V_{OL}	Low Level Output Voltage: Totem Pole & Open-Collector	-	-	0.4	V	$V_{CC} = 4.75, I_{OL} = 12.8 \text{ mA}, I_F = 0 \text{ mA}^{(1)}$
	Inverted Totem-Pole & Inverted Open-Collector	-	-	0.4	V	$V_{CC} = 4.75, I_{OL} = 12.8 \text{ mA}, I_F = 15 \text{ mA}$
V_{OH}	High Level Output Voltage: Totem-Pole & Open-Collector	2.4	-	-	V	$V_{CC} = 4.75, I_{OH} = -800 \mu\text{A}, I_F = 15 \text{ mA}$
	Inverted Totem-Pole & Inverted Open-Collector	2.4	-	-	V	$V_{CC} = 4.75, I_{OH} = -800 \mu\text{A}, I_F = 0 \text{ mA}^{(1)}$
I_{OH}	High Level Output Current: Totem Pole & Open-Collector	-	-	100	μA	$V_{CC} = 4.75, V_{OH} = 30 \text{ V}, I_F = 15 \text{ mA},$
	Inverted Totem-Pole & Inverted Open-Collector	-	-	100	μA	$V_{CC} = 4.75, V_{OH} = 30 \text{ V}, I_F = 0 \text{ mA}^{(1)}$
$I_F(+)$	LED Positive-Going Threshold Current	-	-	15	mA	$V_{CC} = 5.0 \text{ V}$
$I_F(+), I_F(-)$	Hysteresis	-	2.0	-	V	$V_{CC} = 5.0 \text{ V}$
I_{OS}	Short Circuit Output Current: Totem Pole & Open-Collector	-15	-	-60	mA	$V_{CC} = 5.25 \text{ V}, I_F = 15 \text{ mA}, \text{Output} = \text{GND}$
	Inverted Totem-Pole & Inverted Open-Collector	-15	-	-60	mA	$V_{CC} = 5.25 \text{ V}, I_F = 0 \text{ mA}^{(1)}, \text{Output} = \text{GND}$

General Note

TT Electronics reserves the right to make changes in product specification without notice or liability. All information is subject to TT Electronics' own data and is considered accurate at time of going to print.

OPTEK Technology, Inc.
1645 Wallace Drive, Carrollton, TX 75006 | Ph: +1 972 323 2200
www.optekinc.com | www.ttelectronics.com

Electrical Characteristics ($T_A = 25^\circ\text{C}$ unless otherwise noted)

SYMBOL	PARAMETER	MIN	TYP	MAX	UNITS	TEST CONDITIONS
t_r, t_f	Output Rise Time, Output Fall Time	-	70	-	ns	$V_{CC} = 5\text{ V}$, $I_F = 0$ or 15 mA
T_{PLH}	Propagation Delay Low-High	-	5.0	-	μs	$R_L = 8\text{TTL loads (Totem Pole)}$
T_{PHL}	Propagation Delay High-Low	-	5.0	-	μs	$R_L = 360\ \Omega$ (Open-Collector)

Notes:

- (1) Normal application would be with light source blocked, simulated by $I_F = 0$ mA.
- (2) All parameters are tested using pulse techniques.

General Note

TT Electronics reserves the right to make changes in product specification without notice or liability. All information is subject to TT Electronics' own data and is considered accurate at time of going to print.

OPTEK Technology, Inc.
1645 Wallace Drive, Carrollton, TX 75006 | Ph: +1 972 323 2200
www.optekinc.com | www.ttelectronics.com

OPB930_11, OPB940_11 - Flag Next to Emitter

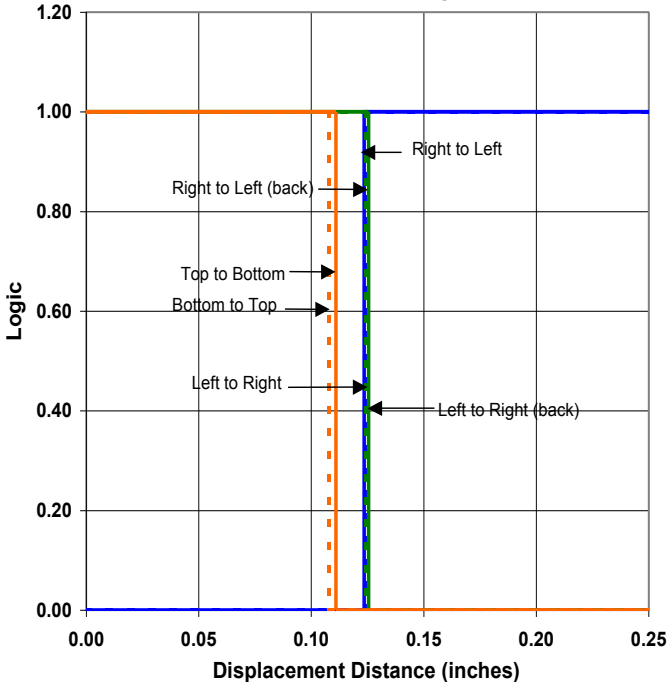

OPB930_11, OPB940_11 - Flag Next to Sensor

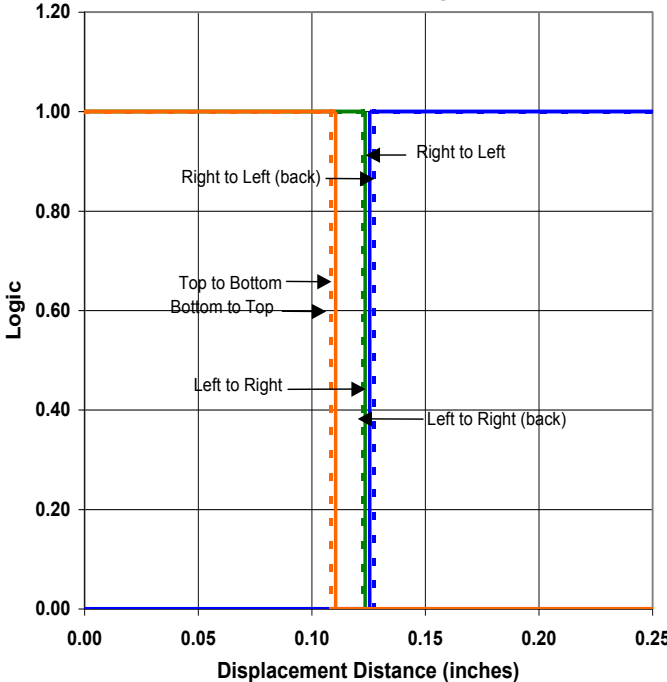

OPB930_11, OPB940_11 - Flag in Middle of Slot

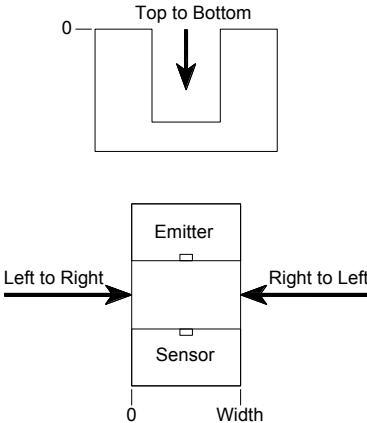
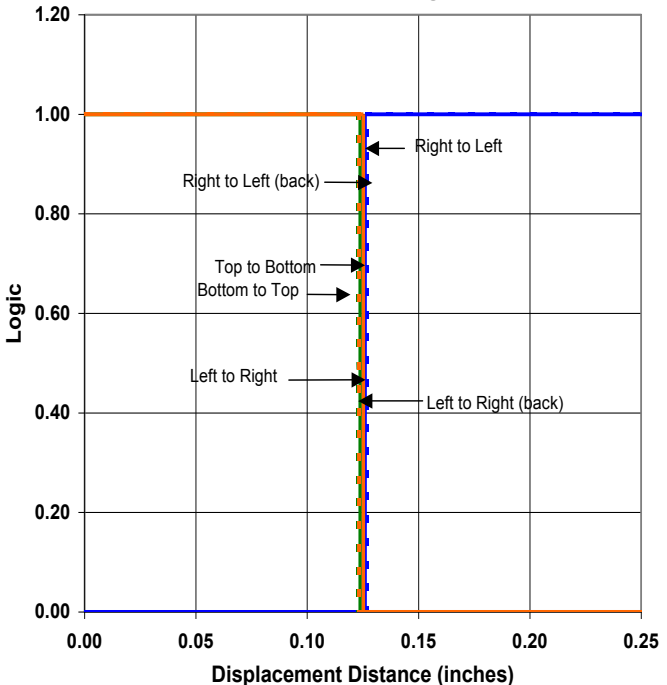

General Note
 TT Electronics reserves the right to make changes in product specification without notice or liability. All information is subject to TT Electronics' own data and is considered accurate at time of going to print.

OPTEK Technology, Inc.
 1645 Wallace Drive, Carrollton, TX 75006 | Ph: +1 972 323 2200
www.optekinc.com | www.ttelectronics.com

OPB930_51, OPB940_51 - Flag Next to Emitter

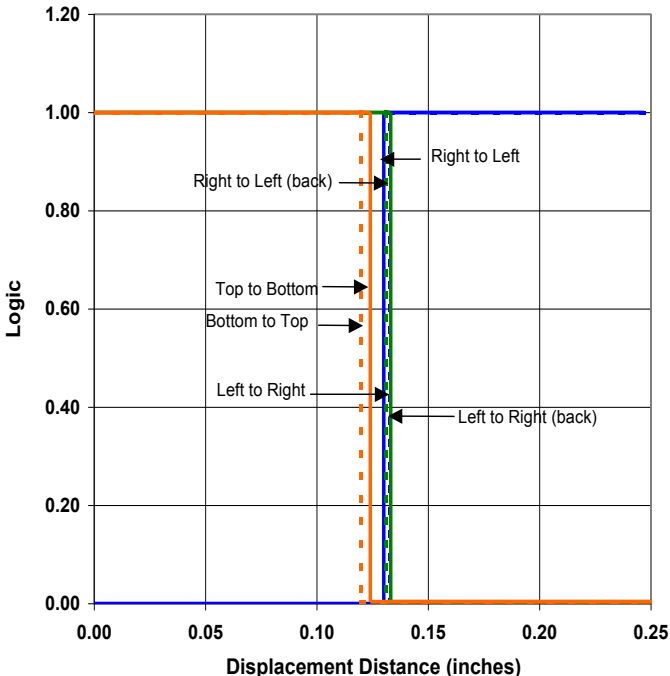

OPB930_51, OPB940_51 - Flag Next to Sensor

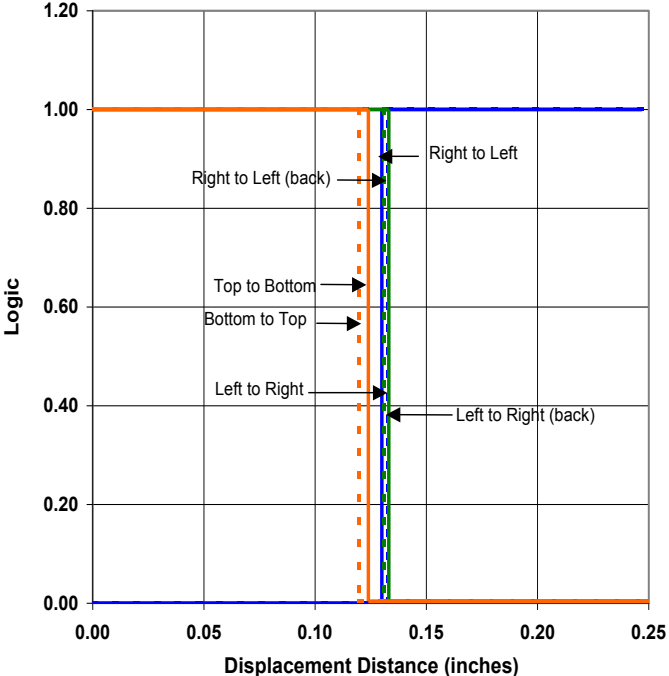

OPB930_51, OPB940_51 - Flag in Middle of Slot

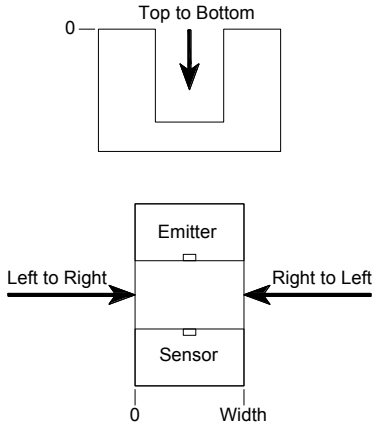
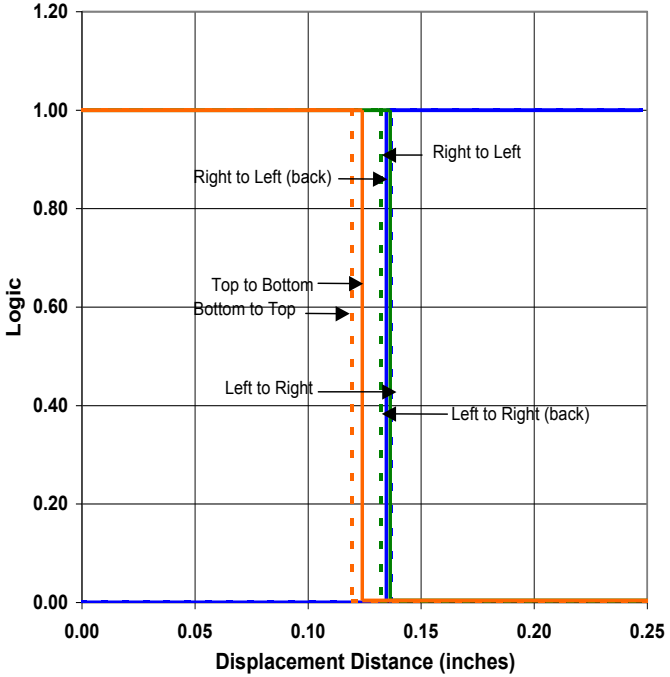

General Note
 TT Electronics reserves the right to make changes in product specification without notice or liability. All information is subject to TT Electronics' own data and is considered accurate at time of going to print.

OPTEK Technology, Inc.
 1645 Wallace Drive, Carrollton, TX 75006 | Ph: +1 972 323 2200
www.optekinc.com | www.ttelectronics.com

OPB930_55, OPB940_55 - Flag Next to Emitter

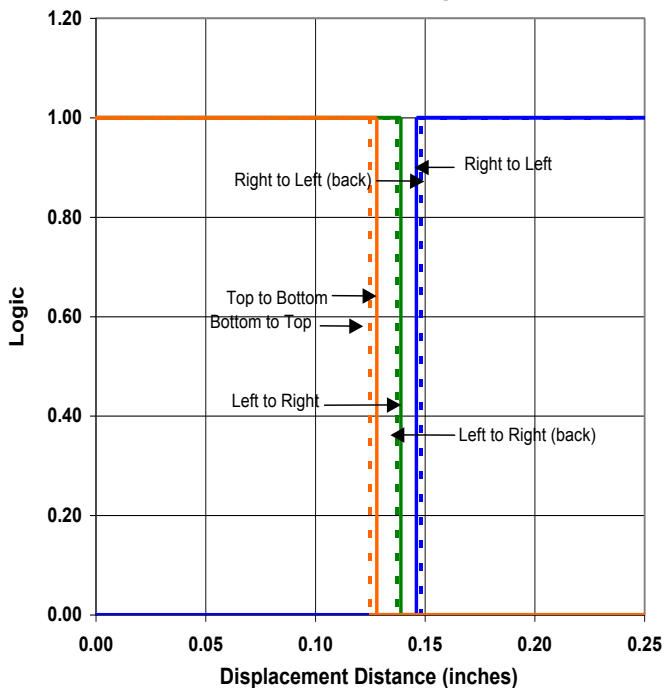

OPB930_55, OPB940_55 - Flag Next to Sensor

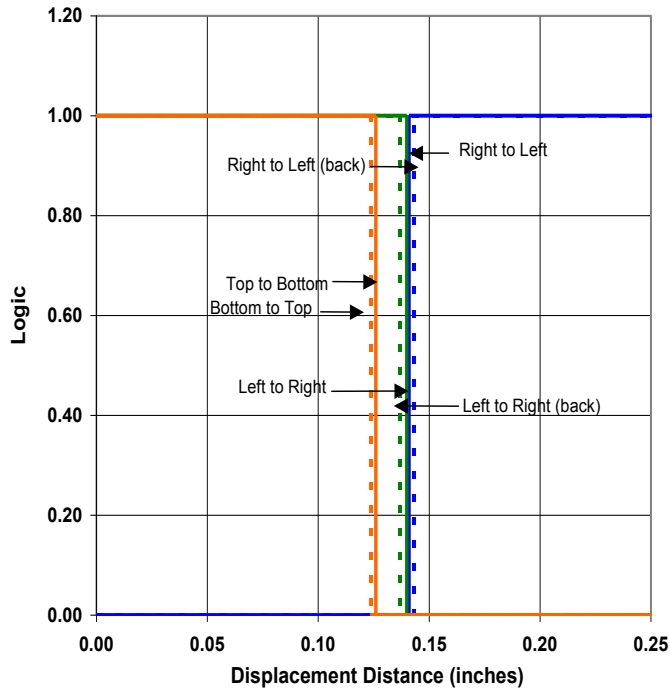

OPB930_55, OPB940_55 - Flag in Middle of Slot

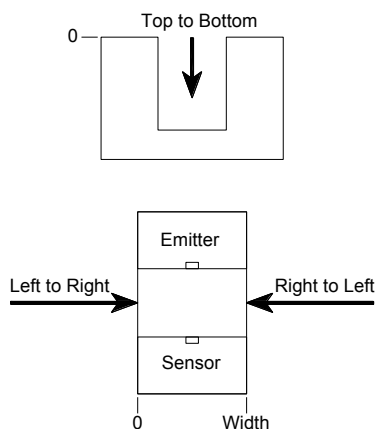
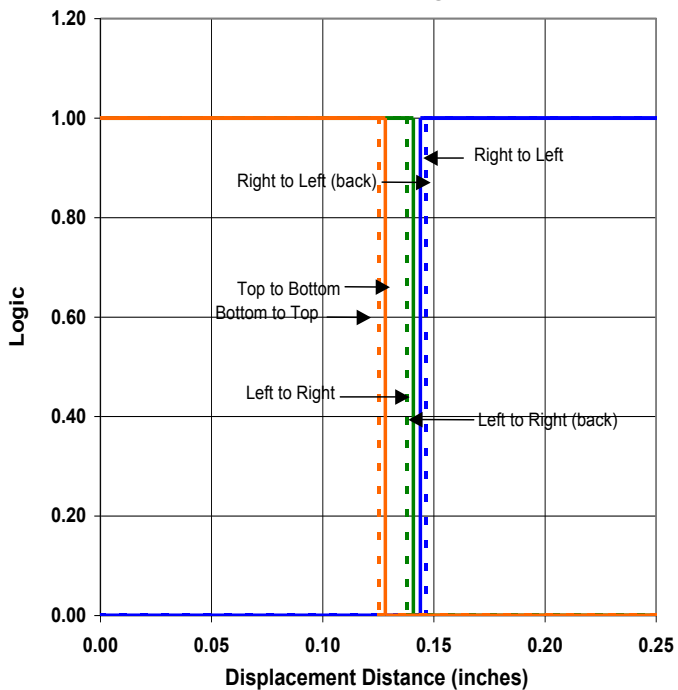

General Note
TT Electronics reserves the right to make changes in product specification without notice or liability. All information is subject to TT Electronics' own data and is considered accurate at time of going to print.

Issue	Change Description	Approval	Date
	Initial Issue (2 unnumbered PDFs - 1 for L series, 1 for W series)		July 1996
A	Revised and put into new template. Required changes on all pages.	Steve Coble	12/21/05
A.1	Updated table on page 4 with proper information	Steve Coble	5/16/07
A.2	Updated table on page 4 with proper nomenclature Icch, Vol, Voh	Bob Procsal	7/22/07
A.3	Added Polysulfone caution information	Bob Procsal	02/20/08
B	Transferred to the new TT Electronics template	L. Timpa	10/7/2016