

# CBM-120

## Mosaic Array Series

### Ultraviolet Chip On Board LEDs

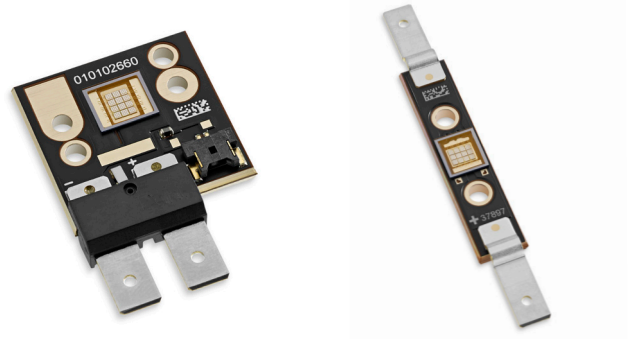

#### Table of Contents

- Technology Overview .....2
- Ordering Information .....3
- Binning Structure .....4
- Ordering Bin Kits .....5
- Optical & Electrical Characteristics .....6
- Typical Spectrum .....8
- Angular Distribution .....8
- Reliability Data .....9
- Thermal Resistance ..... 10
- Electrical Pinout (C31) .... 10
- Mechanical Dimensions Square Package (C31) .... 11
- Mechanical Dimensions Slim Package (C14) ..... 12
- Shipping Tray Square Package (C31) ..... 13
- Shipping Tray Slim Package (C14) ..... 14
- Packaging Specifications . 15
- Revision History ..... 16

#### Features:

- Mosaic Array UV LED chipset with surface emitting area of 12 mm<sup>2</sup>, 4:3 aspect ratio
- All the benefits of chip on board processing without the need for complicated assembly process
- Vertical chip UV LED technology for high power density and uniform emission
- Wide Range of UVA Wavelengths
- High thermal conductivity copper coreboard package
- Low-profile window for efficient coupling into small-extendue systems
- Can be operated at variable drive currents up to 18A
- NIST traceable optical and electrical measurement testing
- Environmentally friendly: RoHS and Halogen compliant

#### Applications:

- Curing:
  - › Inks
  - › Coatings
  - › Adhesives
- Inspection
- Machine Vision
- Fiber-coupled illumination
- Specialty Projection Systems for Maskless Lithography
- Rapid Prototyping and 3D printing
- Medical and Scientific Instrumentation

## Technology Overview

Luminus LEDs benefit from innovations in device technology, chip packaging and thermal management. This suite of technologies give engineers and system designers the freedom to develop solutions both high in power and efficiency.

### Luminus Mosaic Array LED Technology

Luminus' Devices vertical chip technology enables LED chips with uniform brightness over the entire chip surface. The optical power and brightness produced by these densely packed arrays of devices enable solutions not possible with single chip packages that be used to replace arc and halogen lamps.

### Packaging Technology

Thermal management is critical in high power LED applications. With a thermal resistance from junction to heat sink of 0.6 °C/W, Luminus CBM-120 LEDs have the lowest thermal resistance of any UV LED on the market. This will allow the LEDs to be driven at higher current densities while maintaining a low junction temperature, thereby resulting in brighter solutions and longer lifetimes.

### Reliability

With designs based on years of chip and packaging development experience, Luminus LEDs are one of the most reliable light sources in the world today. Luminus LEDs pass a rigorous suite of environmental and mechanical stress tests, including mechanical shock, vibration, temperature cycling and humidity, and have been fully qualified for use in extreme high power and high current applications. With very low failure rates and median lifetimes that can exceed 30,000 hours, Luminus UV LEDs are ready for even the most demanding applications.

### Environmental Benefits

Luminus LEDs help reduce power consumption and the amount of hazardous waste entering the environment. All LED products manufactured by Luminus are RoHS and Halogen compliant and free of hazardous materials, including lead and mercury.

## Understanding Mosaic Array UV LED Test Specifications

Every Luminus LED is fully tested to ensure that it meets the high quality standards expected from Luminus' products.

### Testing Temperature

Luminus core board products are typically measured in such a way that the characteristics reported agree with how the devices will actually perform when incorporated into a system. This measurement is accomplished by mounting the devices on a 40°C heat sink and measuring the device while fully powered. This method of measurement ensures that Luminus LEDs perform in the field just as they are specified.

### Multiple Operating Points

The tables on the following pages provide typical optical and electrical characteristics for the standard drive conditions. Since the LEDs can be operated over a wide range of drive conditions (currents from 200 mA to 18 A, and duty cycle from <1% to 100%) there are many other potential values attainable. Driving devices beyond recommended driving conditions shortens lifetime.

### Ordering Information

| Products   | Ordering Part Number    | Description   |
|------------|-------------------------|---|
| CBM-120-UV | CBM-120-UV-C31-FF###-2# | CBM-120 Mosaic Array UV chipset consisting of 12x1 mm <sup>2</sup> UV LEDs, a thermistor, connectors, and a square copper-core PCB. |
|            | CBM-120-UV-C14-FF###-2# | CBM-120 Mosaic Array UV chipset consisting of 12x1 mm <sup>2</sup> UV LEDs, connectors, and a slim (rectangular) copper-core PCB.   |

### Part Number Nomenclature

CBM — 120 — CC — C## — FF###-2#

| Product Family                     | Chip Area               | Color            | Package Configuration   | Bin Kit <sup>1,2</sup>                       |
|------------------------------------|-------------------------|------------------|---|--|
| CBM: Copper-core PCB, Mosaic Array | 120: 12 mm <sup>2</sup> | UV = Ultraviolet | C14: 44.5 mm x 10 mm - Slim Package<br>C31: 28 mm x 26.75 mm - Square Package<br>See Mechanical Drawing section | See page 5 for complete bin definition table |

Note 1: A Bin Kit represents a group of individual flux or power bins that are shippable for a given ordering part number. Individual flux bins are not orderable.

Note 2: Flux Bin listed is minimum bin shipped - higher bins may be included at Luminus' discretion

### CBM-120-UV Binning Structure

CBM-120-UV LEDs are specified for luminous flux and chromaticity/wavelength at a drive current of 9 A (750 mA/mm<sup>2</sup>) and placed into one of the following Power Bins and Wavelength Bins:

#### Power Bins<sup>3</sup>

| Color | Power Flux Bin (FF) | Minimum Flux (W) | Maximum Flux (W) |
|-------|---------------------|------------------|------------------|
| UV    | FA                  | 6.0              | 6.5              |
|       | FB                  | 6.5              | 7.0              |
|       | GA                  | 7.0              | 7.5              |
|       | GB                  | 7.5              | 8.0              |
|       | H                   | 8.0              | 9.1              |
|       | I                   | 9.1              | 10.0             |
|       | J                   | 10.0             | 11.0             |
|       | K                   | 11.0             | 12.1             |
|       | L                   | 12.1             | 13.3             |

Note 3: Luminus maintains a +/- 6% tolerance on power measurements.

#### Peak Wavelength Bins

| Color | Wavelength Bin (###) | Minimum Wavelength (nm) | Maximum Wavelength (nm) |
|-------|----------------------|-------------------------|-------------------------|
| UV    | 365                  | 365                     | 370                     |
|       | 370                  | 370                     | 375                     |
|       | 375                  | 375                     | 380                     |
|       | 380                  | 380                     | 385                     |
|       | 385                  | 385                     | 390                     |
|       | 390                  | 390                     | 395                     |
|       | 395                  | 395                     | 400                     |
|       | 400                  | 400                     | 405                     |
|       | 405                  | 405                     | 410                     |

**CBM-120 UV Mosaic Array Bin Kits**

| Wavelength Range | Luminous Flux     |           | Wavelength Bins | Ordering Bin Kit Number |
|------------------|-------------------|-----------|-----------------|-------------------------|
|                  | Bin Kit Flux Code | Min. Flux |                 |                         |
| 365-375          | FA                | 6.0       | 365             | FA365-21                |
|                  |                   |           | 365, 370        | FA365-22                |
|                  | FB                | 6.5       | 365             | FB365-21                |
|                  |                   |           | 365, 370        | FB365-22                |
|                  | GB                | 7.7       | 365             | GB365-21                |
|                  |                   |           | 365, 370        | GB365-22                |
|                  | H                 | 8.0       | 365             | H365-21                 |
|                  |                   |           | 365, 370        | H365-22                 |
| 380-390          | K                 | 11.0      | 380             | K380-21                 |
|                  |                   |           | 385             | K385-21                 |
|                  |                   |           | 380, 385        | K380-22                 |
|                  | L                 | 12.1      | 380             | L380-21                 |
|                  |                   |           | 385             | L385-21                 |
|                  |                   |           | 380, 385        | L380-22                 |
| 390-400          | K                 | 11.0      | 390             | K390-21                 |
|                  |                   |           | 395             | K395-21                 |
|                  |                   |           | 390, 395        | K390-22                 |
|                  | L                 | 12.1      | 390             | L390-21                 |
|                  |                   |           | 395             | L395-21                 |
|                  |                   |           | 390, 395        | L390-22                 |
| 400-410          | K                 | 11.0      | 400             | K400-21                 |
|                  |                   |           | 405             | K405-21                 |
|                  |                   |           | 400, 405        | K400-22                 |
|                  | L                 | 12.1      | 400             | L400-21                 |
|                  |                   |           | 405             | L405-21                 |
|                  |                   |           | 400, 405        | L400-22                 |

**Reference Optical & Electrical Characteristics ( $T_{hs} = 40^{\circ}\text{C}$ )<sup>4,5</sup>**

| UV                            |                       |                     |           |           |           |                   |
|-------------------------------|-----------------------|---------------------|-----------|-----------|-----------|-------------------|
| Parameter                     | Symbol                | Values <sup>6</sup> |           |           |           | Unit              |
| Peak Wavelength Range         | $\lambda$             | 365 - 375           | 380-390   | 390-400   | 400-410   | nm                |
| Drive Conditions <sup>7</sup> | $I$                   | 9.0                 | 9.0       | 9.0       | 9.0       | A                 |
| Peak Wavelength Typ.          | $\lambda_p$           | 368                 | 384   387 | 393   397 | 403   407 | nm                |
| Current Density               | $j$                   | 0.75                | 0.75      | 0.75      | 0.75      | A/mm <sup>2</sup> |
| Forward Voltage               | $V_{Fmin}$            | 3.0                 | 3.0       | 3.0       | 3.0       | V                 |
|                               | $V_F$                 | 3.6                 | 3.6       | 3.6       | 3.6       | V                 |
|                               | $V_{Fmax}$            | 4.0                 | 4.0       | 4.0       | 4.0       | V                 |
| Radiometric Flux <sup>8</sup> | $\Phi_{typ}$          | 8.5                 | 11.5      | 11.5      | 11.5      | W                 |
| FWHM at 50% of $\Phi$         | $\Delta\lambda_{1/2}$ | 14                  | 14        | 14        | 14        | nm                |

| Parameter  | Symbol     | Values                         | Unit            |
|--|------------|--------------------------------|-----------------|
| Absolute Minimum Current (CW or Pulsed) <sup>9</sup>   |            | 0.2                            | A               |
| Absolute Maximum Current (CW) <sup>10</sup>  |            | 365nm - 12<br>380nm-410nm - 18 | A               |
| Absolute Maximum Surge Current <sup>10</sup><br>(Frequency > 240 Hz, duty cycle =10%, t=1ms) |            | 30                             | A               |
| Maximum Junction Temperature <sup>11</sup>   | $T_{jmax}$ | 100                            | °C              |
| Storage Temperature Range  |            | -40 to +100                    | °C              |
| Emitting Area  |            | 12.9                           | mm <sup>2</sup> |
| Emitting Area Dimensions   |            | 4.50 × 3.32                    | mm × mm         |

Note 4: Data verified using NIST traceable calibration standard.

Note 5: All data are based on test conditions with a constant heat sink temperature  $T_{hs} = 40^{\circ}\text{C}$  under pulse testing conditions. Pulse conditions: 25% duty-cycle, frequency of 720Hz, 3 second soak.

Note 6: Unless otherwise noted, values listed are typical. Devices are production tested and specified at 9 A.

Note 7: Listed drive conditions are typical for common applications. CBM120-UV devices can be driven at currents ranging from 200 mA to 12A-18 A and at duty cycles ranging from 1% to 100%. Drive current and duty cycle should be adjusted as necessary to maintain the junction temperature desired to meet application lifetime requirements.

Note 8: Typical total flux from emitting area at listed peak wavelength. Reported performance is included to show trends for a selected power level. For specific minimum and maximum values, use bin tables. For product roadmap and future performance of devices, contact Luminus.

Note 9: Special design considerations must be observed for operation under 1 A. Please contact Luminus for further information.

Note 10: CBM-120-UV LEDs are designed for operation to an absolute maximum current as specified above. Product lifetime data is specified at recommended forward drive currents. Sustained operation at or beyond absolute maximum currents will result in a reduction of device life time compared to recommended forward drive currents. Actual device lifetimes will also depend on junction temperature. Refer to the lifetime derating curves for further information. In pulsed operation, rise time from 10-90% of forward current should be longer than 0.5  $\mu\text{seconds}$ .

Note 11: Lifetime dependent on LED junction temperature. Input power and thermal system must be properly managed to ensure lifetime.

### Optical & Electrical Characteristics

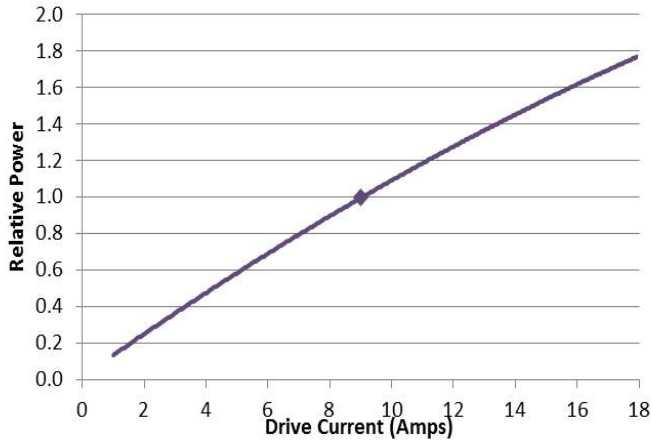
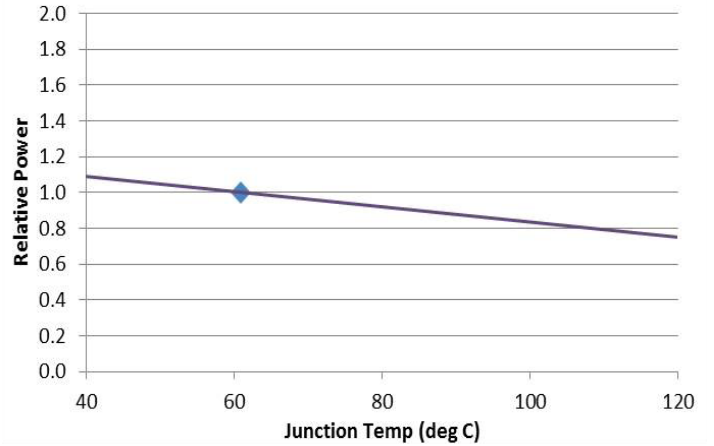
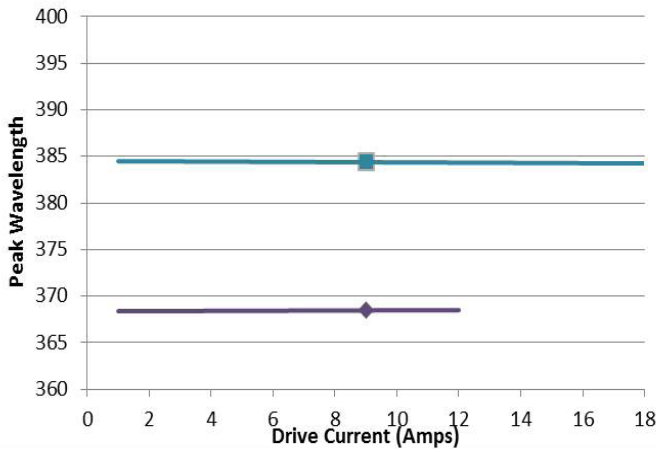
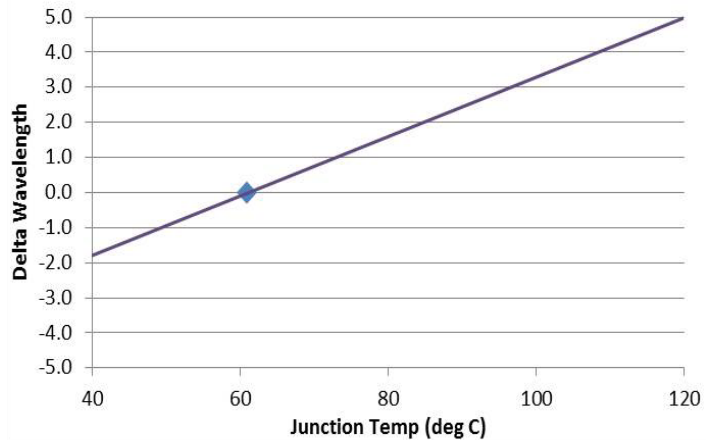
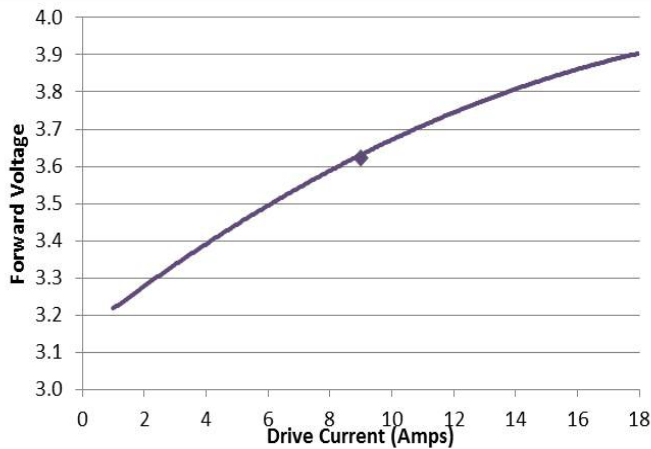
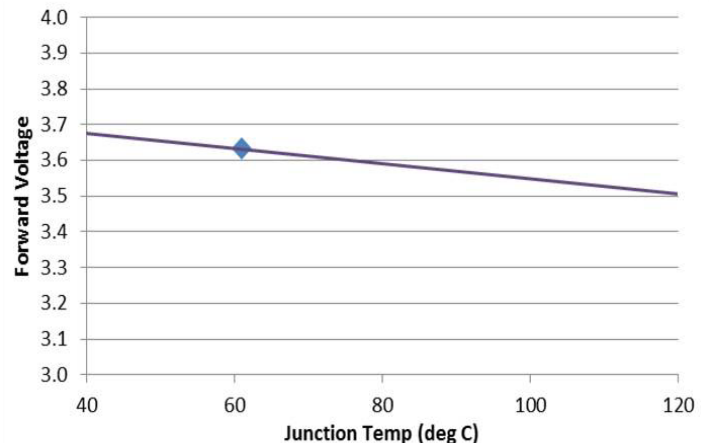
**Relative Power vs Forward Current,  $T_j = 60^\circ\text{C}$** 

**Relative Power vs Junc. Temperature,  $I_f = 9\text{ A}$** 

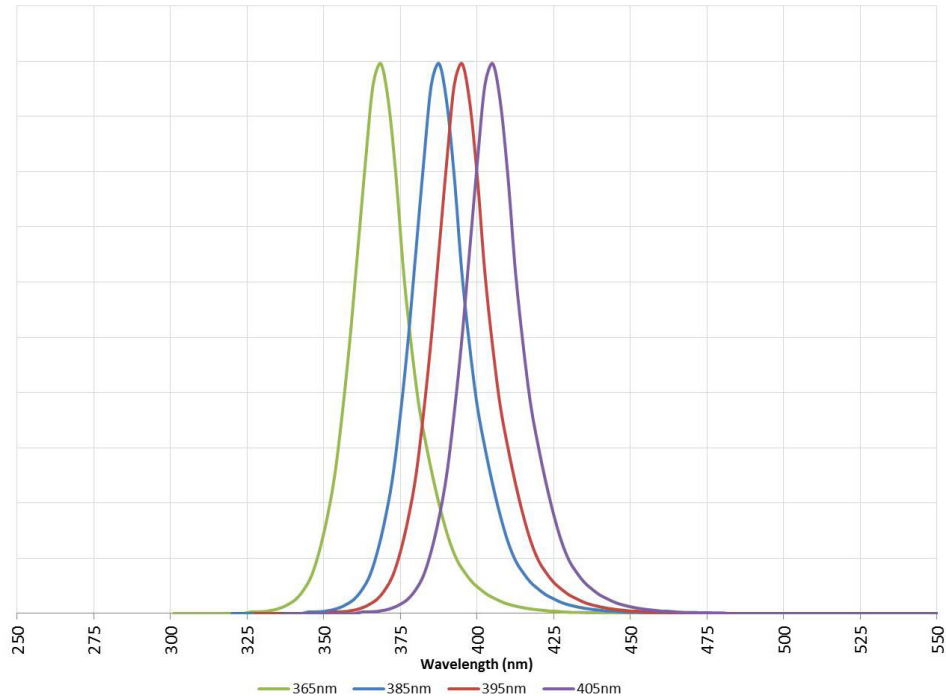
**Peak Wavelength vs Forward Current**

**Peak Wavelength vs Junction Temperature**

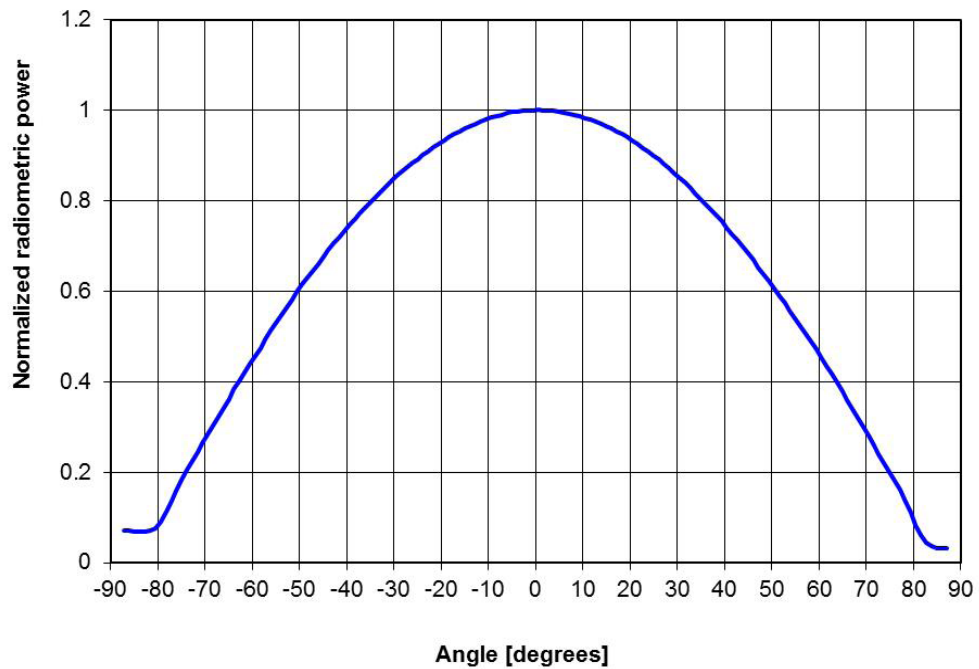
**Forward Voltage vs Forward Current**

**Forward Voltage vs Junction Temperature**

### Typical Spectrum <sup>12</sup>



### Emission Angle <sup>13</sup>



Note 12: Typical spectrum at current of 9 A in continuous operation.

Note 13: Detailed information on emission including ray trace files can be found at: <http://www.luminus.com/resource/design.html>

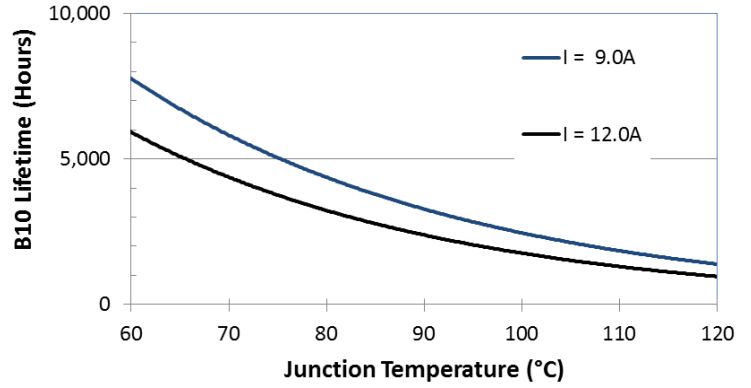
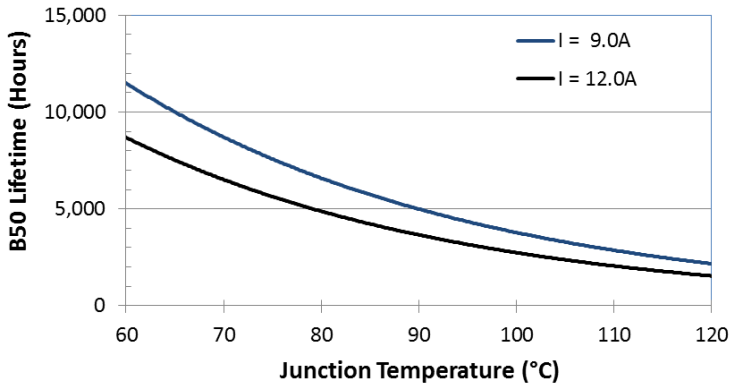
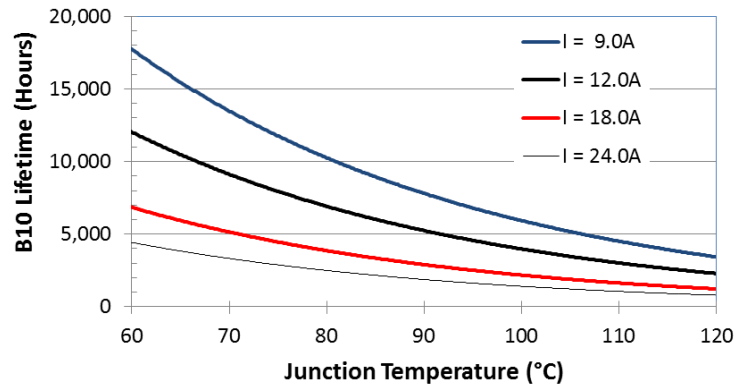
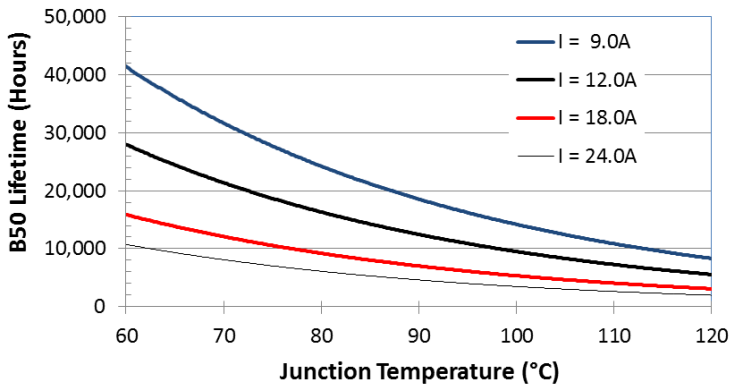

**Reliability Data - 365nm**

**Reliability Data - 380nm-410nm**

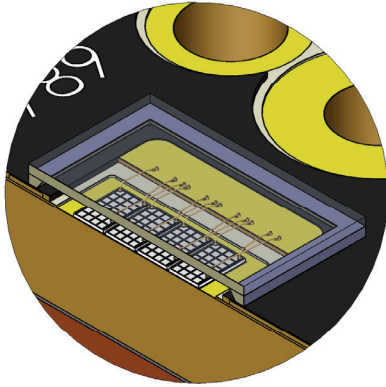
### Thermal Resistance CBM-120-UV

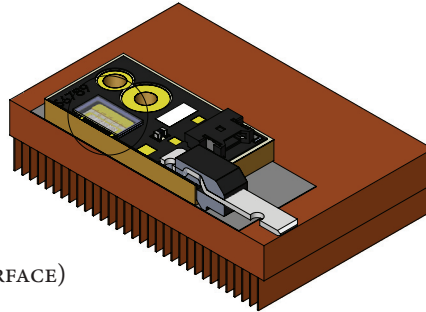

T<sub>J</sub> = DIE JUNCTION TEMP  
 T<sub>B</sub> = COREBOARD TEMP  
 T<sub>HS</sub> = HEATSINK TEMP (3MM FROM SURFACE)  
 T<sub>REF</sub> - THERMISTOR TEMP



#### Typical Thermal Resistance<sup>14</sup> - C31

|                                   |           |
|-----------------------------------|-----------|
| R <sub>θj-b</sub> <sup>15</sup>   | 0.61 °C/W |
| R <sub>θb-hs</sub> <sup>16</sup>  | 0.12 °C/W |
| R <sub>θj-hs</sub> <sup>16</sup>  | 0.73 °C/W |
| R <sub>θj-ref</sub> <sup>15</sup> | 0.64 °C/W |

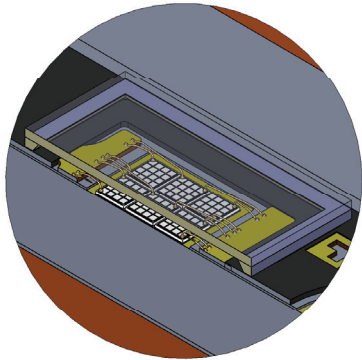

T<sub>J</sub> = DIE JUNCTION TEMP  
 T<sub>B</sub> = COREBOARD TEMP  
 T<sub>HS</sub> = HEATSINK TEMP (3MM FROM SURFACE)

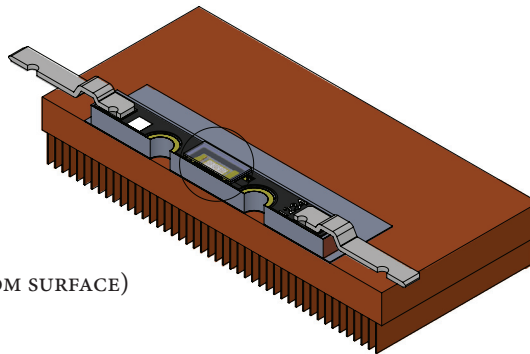

#### Typical Thermal Resistance<sup>14</sup> - C14

|                                  |           |
|----------------------------------|-----------|
| R <sub>θj-b</sub> <sup>15</sup>  | 0.76 °C/W |
| R <sub>θb-hs</sub> <sup>16</sup> | 0.12 °C/W |
| R <sub>θj-hs</sub> <sup>16</sup> | 0.88 °C/W |

Note 14: Real thermal resistance data - "Electrical" thermal resistance values available upon request

Note 15: Thermal resistance values are based on measured wavelength shift data.

Note 16: Thermal Resistance is based on eGraf 1205 Thermal interface.

### Electrical Pinout - C31 Package

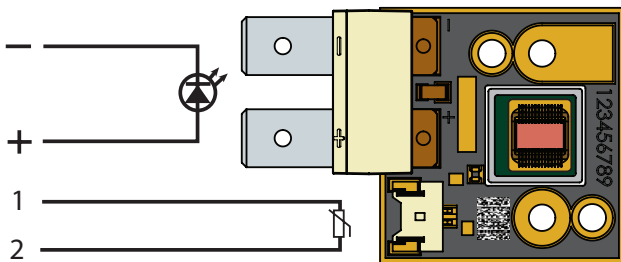

The thermistor used in CBT-120 devices mounted on coreboards is from Murata Manufacturing Co. The global part number is NCP18XH103J03RB. Please see <http://www.murata.com/> for details on calculating thermistor temperature.

For more information on use of the thermistor, please contact Luminus directly.

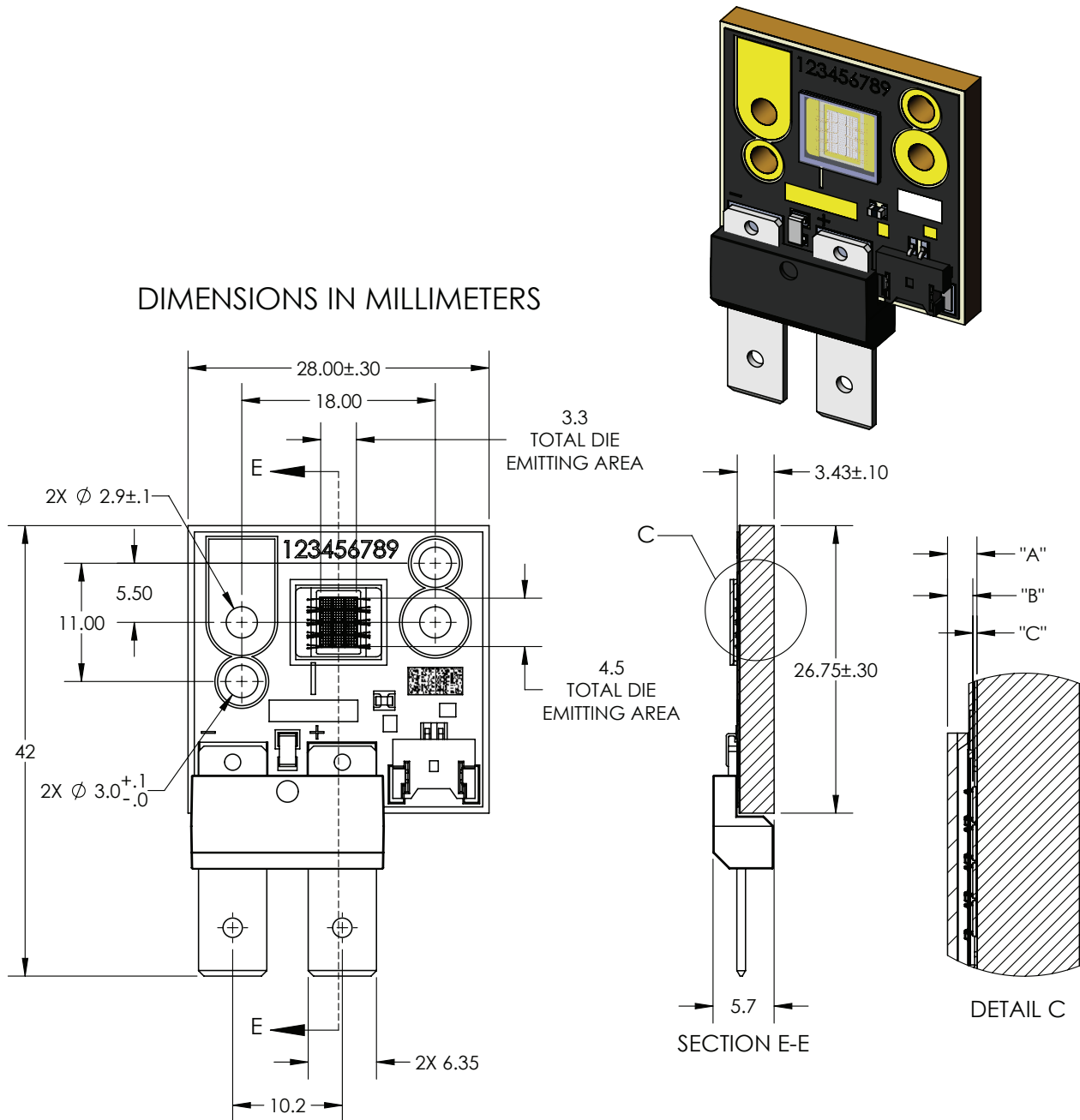
**Mechanical Dimensions – CBM-120-UV-C31 Mosaic Array LED Emitter**

| DIMENSION NAME | DESCRIPTION  | NOMINAL DIMENSION | TOLERANCE |
|----------------|--|-------------------|-----------|
| "A"            | TOP OF METAL SUBSTRATE TO TOP OF WINDOW            | .91               | ±.13      |
| "B"            | TOP OF DIE EMITTING AREA TO TOP OF WINDOW          | .78               | ±.11      |
| "C"            | TOP OF METAL SUBSTRATE TO TOP OF DIE EMITTING AREA | .13               | ±.02      |

Recommended connector for Anode and Cathode: Panduit Disco Lok™ Series P/N: DNG14-250FL-C.  
 Thermistor Connector: MOLEX P/N 53780-0270 or GCT P/N WTB08-021S-F.  
 Recommended Female: MOLEX P/N 51146-0200, GCT P/N WTB06-021S-F or equivalent

DWG-002558

**Mechanical Dimensions – CBM-120-UV-C14 Mosaic Array LED Emitter**

DIMENSIONS IN MILLIMETERS

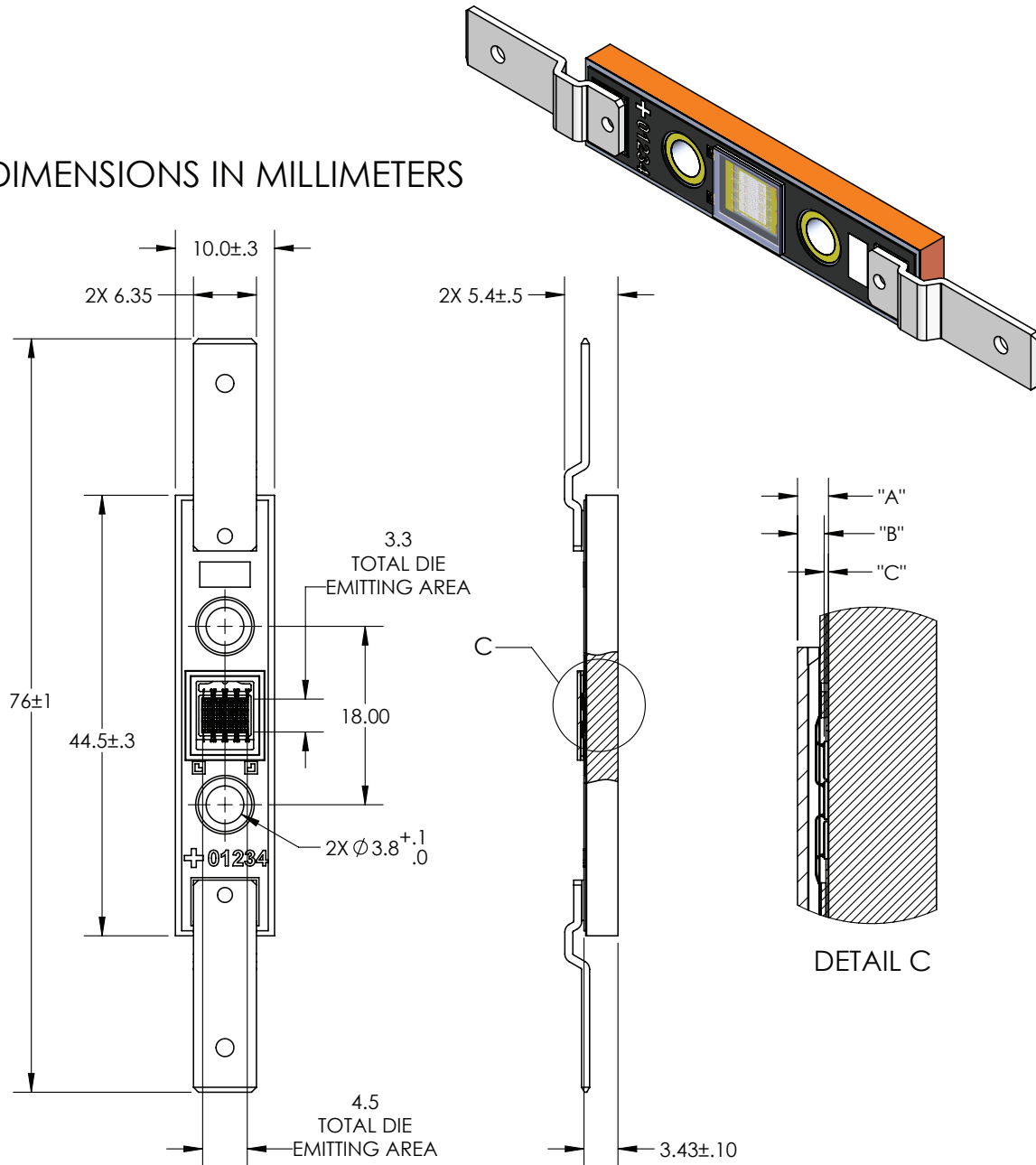

| DIMENSION NAME | DESCRIPTION  | NOMINAL DIMENSION | TOLERANCE |
|----------------|--|-------------------|-----------|
| "A"            | TOP OF METAL SUBSTRATE TO TOP OF WINDOW            | .91               | ±.13      |
| "B"            | TOP OF DIE EMITTING AREA TO TOP OF WINDOW          | .78               | ±.11      |
| "C"            | TOP OF METAL SUBSTRATE TO TOP OF DIE EMITTING AREA | .13               | ±.02      |

DWG-002534

Recommended connector for Anode and Cathode: Panduit Disco Lok™ Series P/N: DNG14-250FL-C.

### Shipping Tray Outline - CBM-120-C31

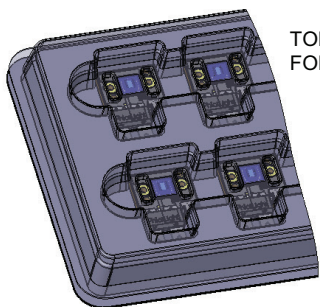
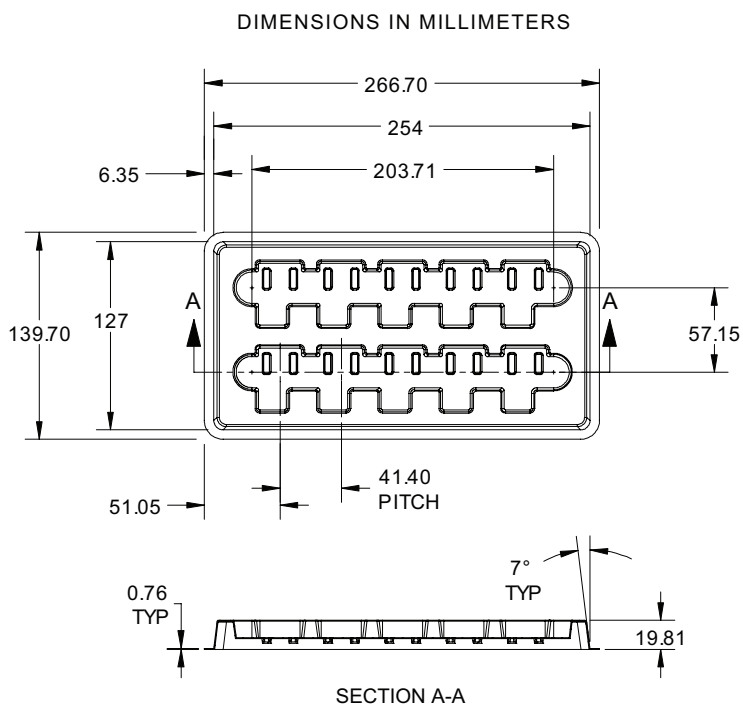

TOP TRAY SHOWN TRANSPARENT FOR REFERENCE ONLY

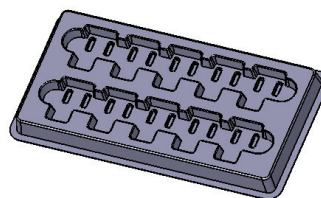

### Shipping Tray Outline - CBM-120-C14

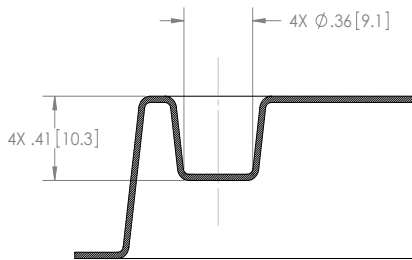
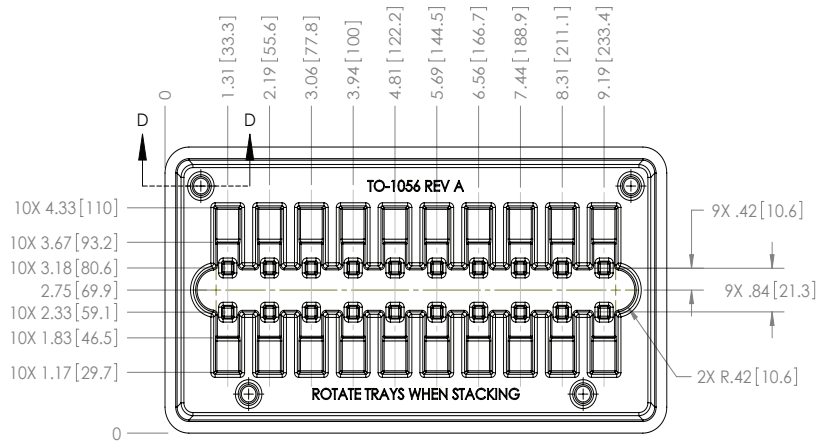

SECTION D-D  
SCALE 2:1

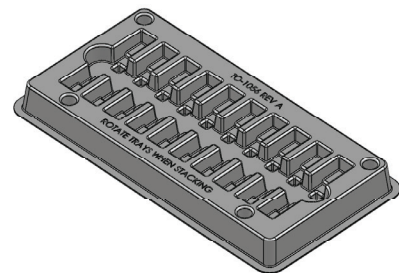

## Packing and Shipping Specification (CBM-120)

### Packing Specification

| Packing Configuration   | Qty /Pack | Box Dimensions<br>(diameter x W, mm) | Gross Weight (kg) |
|---|-----------|--------------------------------------|-------------------|
| Stack of 5 trays with 10 devices per tray<br>Each pack is enclosed in ESD bag | 50        | 140 x 280 x 70                       | 2.7               |

### Product Label Specification

#### Label Fields (subject to change):

- 6-8 digit Box number (for Luminus internal use)
- Luminus ordering part number
- Quantity of devices in pack
- Part number revision (for Luminus internal use)
- Customer's part number (optional)
- Flux Bin
- 2D Bar code





**LUMINUS**  
LEADER IN BIG CHIP LEDS    Solid State Filament™

BT-012345  
  
Box number

Qty: 50  



PT-120-G-L11-MPG  
  
Luminus part number

Rev 01  

12345678  
  
Customer part number

5F  
  
Bin

RoHS Compliant

for traceability peel off label and attach

Sample label –for illustration only

### Shipping Box

| Shipping Box | Quantity                           | Material | Dimensions<br>(L x W x H, mm) |
|--------------|------------------------------------|----------|-------------------------------|
| Carton Box   | 1 -20 packs<br>(50 - 1000 Devices) | S4651    | 560 x 560 x 200               |



## History of Changes

| Rev | Date       | Description of Change  |
|-----|------------|--|
| A   | 01/09/2015 | Initial Release - Preliminary Specifications for 365nm and 380nm CBM-120 Parts |
| B   | 03/20/2015 | Added Data for 390nm and 400nm CBM-120 Parts, Updated binning structure        |
| 01  | 05/31/2015 | Updated Binning, Added Angular Distribution Data, Added Reliability Data       |
| 02  | 09/18/2015 | Updated Binning  |
| 03  | 03/29/2016 | Updated Binning  |

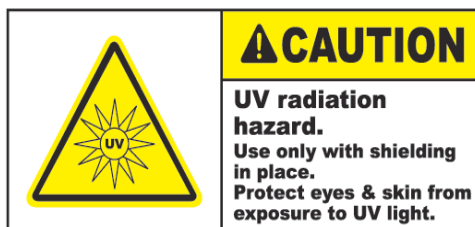

The products, their specifications and other information appearing in this document are subject to change by Luminus Devices without notice. Luminus Devices assumes no liability for errors that may appear in this document, and no liability otherwise arising from the application or use of the product or information contained herein. None of the information provided herein should be considered to be a representation of the fitness or suitability of the product for any particular application or as any other form of warranty. Luminus Devices' product warranties are limited to only such warranties as accompany a purchase contract or purchase order for such products. Nothing herein is to be construed as constituting an additional warranty. No information contained in this publication may be considered as a waiver by Luminus Devices of any intellectual property rights that Luminus Devices may have in such information. Big Chip LEDs™ is a registered trademark of Luminus Devices, Inc., all rights reserved.

This product is protected by U.S. Patents 6,831,302; 7,074,631; 7,083,993; 7,084,434; 7,098,589; 7,105,861; 7,138,666; 7,166,870; 7,166,871; 7,170,100; 7,196,354; 7,211,831; 7,262,550; 7,274,043; 7,301,271; 7,341,880; 7,344,903; 7,345,416; 7,348,603; 7,388,233; 7,391,059 Patents Pending in the U.S. and other countries.