

CAB426RF: I-PEX MHF 4L LK PLUG + RP SMA RIGHT ANGLE BULKHEAD JACK WITH O-RING RATED TO IP67/68 + 1.37MM CABLE, 6GHz

SPECIFICATIONS :

1. I-PEX MHF 4L LK PLUG, P/N:20632-001R-37.
LOCK: 3615-000
2. 1.37MM COAXIAL CABLE, COLOR: BLACK
3. RP SMA RIGHT ANGLE BULKHEAD JACK WITH O-RING RATED TO IP67/68, P/N: RFCT-SMA078-F37.

USAGE PRECAUTIONS: CABLES USING 'MICRO' COAX ARE DELICATE:
 (i) HANDLE WITH CARE.
 (ii) DO NOT TWIST; APPLY EXCESSIVE FORCES OR SHARP BENDS TO THE CABLE. DO NOT FORCEFULLY DEFORM WIRES.
 (iii) CONSULT CONNECTOR MANUFACTURER'S DATASHEETS FOR DETAILED NOTES ON HANDLING INSTRUCTIONS.

ENVIRONMENTAL:

- A. BULKHEAD MOUNTED CONNECTOR (RFCT-SMA078-F37) RATED TO THE FOLLOWING SPECIFICATION:
- i. IP6X - DUST TIGHT - NO PARTICLE INGRESS.
 - ii. IPX7 WATERPROOF FOR 30 MINUTES UP TO 1 METER UNDERWATER.
 - iii. IPX8 WATERPROOF FOR 48 HOURS AT 1 METER UNDERWATER.

NOTES:

1. THE ORIENTATION OF CONNECTORS ON DRAWING IS FOR REFERENCE ONLY, IF THE ORDER IS LEFT BLANK THE CONNECTOR WILL NOT HAVE FIXED ORIENTATION.
2. FIXED ORIENTATION IS SUGGESTED FOR CABLE LENGTH 50MM TO 100MM. PLEASE SPECIFY THE FIXED ORIENTATIONS FROM THE ORDER CODE (F1, F2, ETC)
3. CONTACT GRADCONN IF THE ORIENTATION YOU REQUIRE IS NOT SHOWN.
4. WORKING FREQUENCY RANGE: DC-6GHz.
5. OPERATING TEMPERATURE: -40°C~+85°C.
6. IMPEDANCE: 50 Ohm.

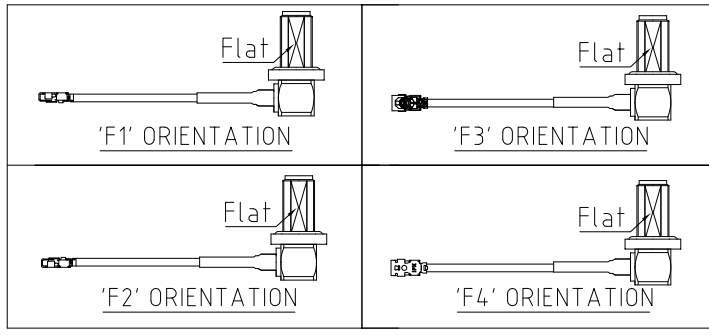
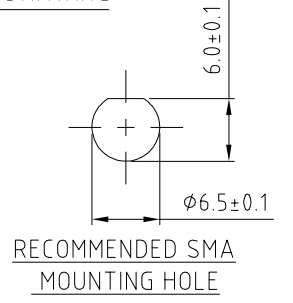
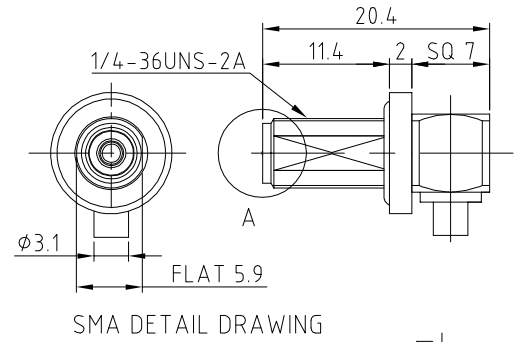
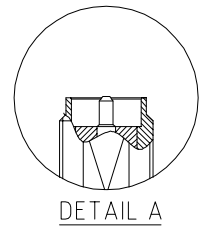
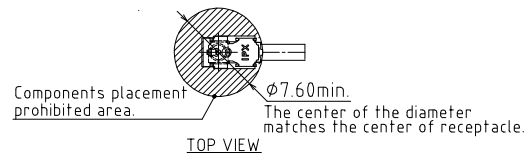
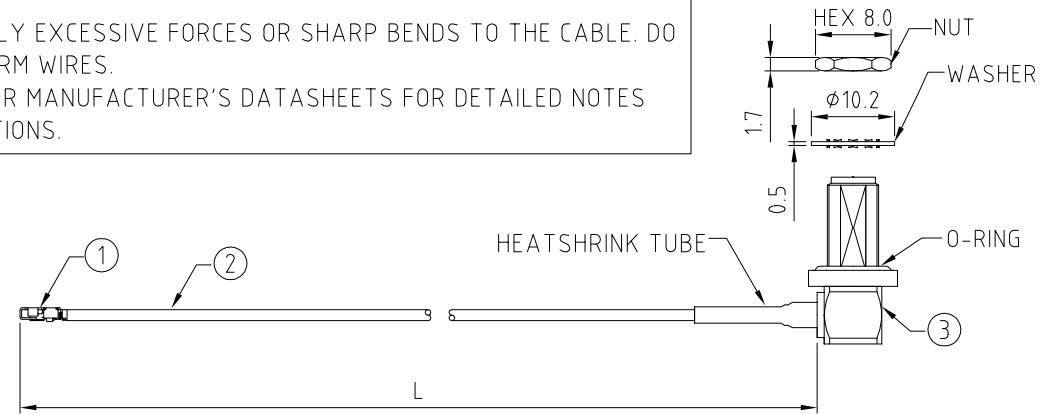
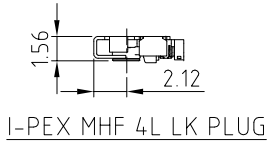

HOW TO ORDER
 CAB426RF - X X X X - X X - X - 1

"L" LENGTH IN MM:
 eg: 100MM = 0100
 (MIN. 0050-MAX.0400)
 STANDARD = 0100, 0150, 0200
 Tolerance: 50-200mm: ±5mm.
 201-400mm: ±7mm.

CABLE SIZE:
 1 = Ø1.37MM CABLE, COLOR: BLACK
 WASHER AND NUT OPTIONS:
 BLANK = SEPARATELY PACKED (STANDARD)
 A = ASSEMBLED WITH CONNECTOR

ORIENTATION OPTIONS:
 BLANK = DOES NOT HAVE A FIXED ORIENTATION
 F1 = MHF CONNECTION DOWN (L=50-200MM)
 F2 = MHF CONNECTION UP (L=50-200MM)
 F3 = MHF CONNECTION AND D FLAT SAME ORIENTATION (L=50-200MM)
 F4 = MHF CONNECTION AND D FLAT OPPOSITE ORIENTATION (L=50-200MM)
 (SEE NOTES 1, 2, 3 AND DIAGRAMS FOR MORE INFORMATION)

REV. DATE & DRN
 TO: 11/09/20 - NYW RELEASE
 11_05/05/21 - NYW
 AMEND MHF 4L LK DRAWING

Scale: NTS	THIRD ANGLE	Unstated X XX XXX ANGLES	Tolerances: N/A N/A N/A N/A
Drawn: NYW			
App'd: XXX	Title CABLE ASSEMBLY		
Date: 5 MAY '21	Revision: 1.1	Unit: mm	



IP67/68 Rated Cables

www.gradconn.com

THIS DRAWING IS CONFIDENTIAL AND MUST NOT BE COPIED OR DISCLOSED WITHOUT WRITTEN CONSENT

Drawing Number: CAB426RF	
Sheet 1	of 1
Drawing	E and O E