

Contact Information

**560-Make Before Break (MBB) - Tail LG.=.190(4.83)
 .100" (2.54mm) Contact Spacing x .200" (5.08mm) Row Spacing**

THIS IS A C.A.D. GENERATED DRAWING
 DO NOT MAKE MANUAL REVISIONS TO MASTER.



ISSUE NUMBER

ORIGINAL ①

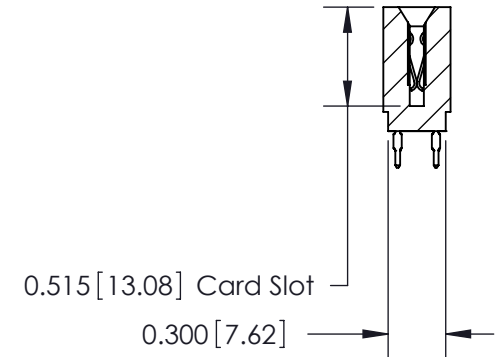
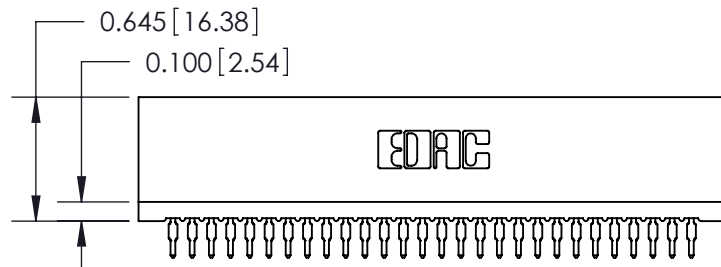
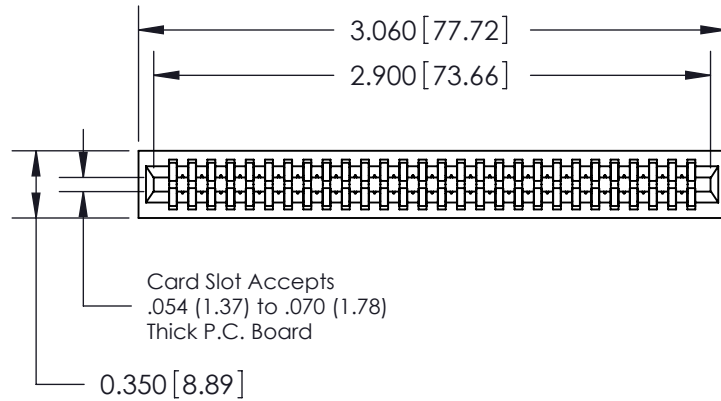

745 Series Ultra-Mate Card Edge Connector - Press Fit

Part Number: 745-056-560-201



YOUR CONNECTION TO QUALITY & SERVICE

EDAC INC
 TORONTO, ONTARIO
 CANADA

THESE DRAWINGS AND SPECIFICATIONS
 ARE THE PROPERTY OF EDAC INC. AND
 SHALL NOT BE REPRODUCED, OR COPIED
 OR USED AS THE BASIS FOR THE
 MANUFACTURE OR SALE OF APPARATUS
 WITHOUT WRITTEN PERMISSION.

ACAD REFERENCE NO. 745-ENG MASTER	
DRAWN: J.LEE	DATE: MAY 04/09
CHECKED:	DATE:
SCALE:	SHEET 1 OF 2
DRAWING NUMBER 745-ENG MASTER	ISSUE 1