

Flush-type connector - SACC-CI-M12MS-8CON-L90 SCO - 1436987

Please be informed that the data shown in this PDF Document is generated from our Online Catalog. Please find the complete data in the user's documentation. Our General Terms of Use for Downloads are valid (<http://phoenixcontact.com/download>)

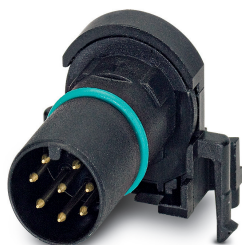

Sensor/actuator flush-type connector, plug, 8-pos., A-coded, with angled solder connection, only contact insert

Your advantages

- ✓ Reduced mounting costs thanks to two-piece device connector
- ✓ All common pin assignments and codings available
- ✓ Easy device integration thanks to mechanical port screw connections with threaded attachment, press-in contour or direct integration in the front plate
- ✓ Additional gasket for the device when not plugged in



Key Commercial Data

Packing unit	20 pc
Minimum order quantity	20 pc
GTIN	 4 046356 438551
GTIN	4046356438551

Technical data

Ambient conditions

Ambient temperature (operation)	-25 °C ... 85 °C (Plug / socket)
	-40 °C ... 85 °C (without mechanical actuation)
	-25 °C ... 85 °C (Plug / socket)
Degree of protection	IP67

General

Note	The electrical and mechanical data specified assume that the connector pair is correctly locked and mounted. If the connector is unlocked and if there is a danger of contamination, the connector must be sealed using a protective cap > IP54. Influences arising from litz wires, cables or PCB assembly must also be taken into consideration.
Rated current at 40°C	2 A

Flush-type connector - SACC-CI-M12MS-8CON-L90 SCO - 1436987

Technical data

General

Rated voltage	30 V
Rated surge voltage	0.8 kV
Number of positions	8
Insulation resistance	≥ 100 MΩ
Coding	A - standard
Standards/regulations	M12 connector IEC 61076-2-101
Status display	No
Overvoltage category	II
Degree of pollution	3
Connection method	Solder pins
Insertion/withdrawal cycles	> 100
Torque	3 Nm ... 4 Nm (Installation-side)
Mounting type	PCB mounting

Material

Flammability rating according to UL 94	V0
Contact material	CuZn
Contact surface material	Au
Contact carrier material	PA 6.6
Sealing material	FKM / EPDM

Cable

Standards/specifications	M12 connector IEC 61076-2-101
--------------------------	-------------------------------

Standards and Regulations

Standards/specifications	M12 connector IEC 61076-2-101
Flammability rating according to UL 94	V0
Standards/specifications	M12 connector IEC 61076-2-101

Environmental Product Compliance

REACH SVHC	Lead 7439-92-1
China RoHS	Environmentally Friendly Use Period = 50 years
	For details about hazardous substances go to tab "Downloads", Category "Manufacturer's declaration"

Drawings

Flush-type connector - SACC-CI-M12MS-8CON-L90 SCO - 1436987

Schematic diagram

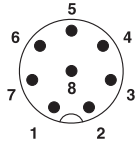

Pin assignment M12 plug, 8-pos., A-coded, view plug side

Drilling diagram

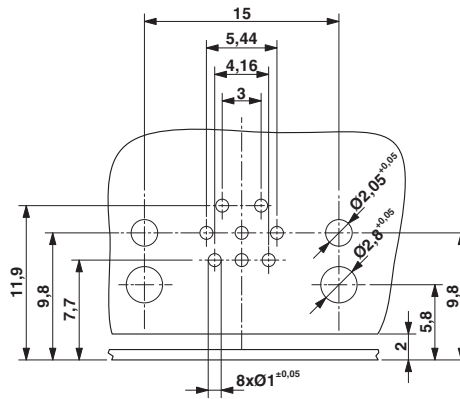

Drilling diagram only valid in connection with the SACC-M12-SCO PLUG L90 housing (order no. 1436709)

Dimensional drawing

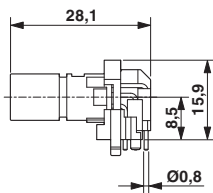

M12 flush-type connector, plug, contact carrier, side view

Dimensional drawing

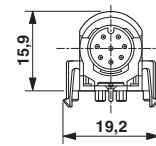

M12 flush-type connector, plug, contact carrier, front view

Dimensional drawing

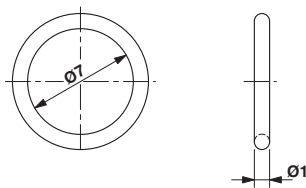

Optionally with O-ring (green) for tight seal when plugged in.
 - the axial mating force of 80 N per connector may not be exceeded when using with assembled O-ring!
 - Avoid radial forces!

Dimensional drawing

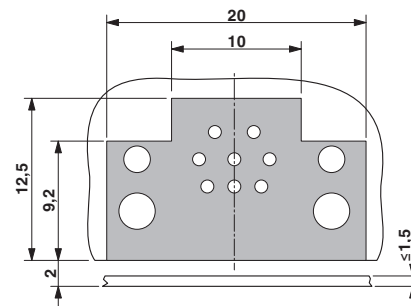

Locked area on the PCB

Classifications

eCl@ss

eCl@ss 10.0.1	27440102
eCl@ss 11.0	27440102
eCl@ss 4.0	27260700

Flush-type connector - SACC-CI-M12MS-8CON-L90 SCO - 1436987

Classifications

eCl@ss

eCl@ss 4.1	27260700
eCl@ss 5.0	27260700
eCl@ss 5.1	27260700
eCl@ss 6.0	27279200
eCl@ss 7.0	27440103
eCl@ss 9.0	27440102

ETIM

ETIM 3.0	EC002061
ETIM 4.0	EC002061
ETIM 6.0	EC002061
ETIM 7.0	EC002635

UNSPSC

UNSPSC 6.01	31251501
UNSPSC 7.0901	31251501
UNSPSC 11	31251501
UNSPSC 12.01	31251501
UNSPSC 13.2	39121413
UNSPSC 18.0	39121413
UNSPSC 19.0	39121413
UNSPSC 20.0	39121413
UNSPSC 21.0	39121413

Approvals

Approvals

Approvals

UL Recognized / EAC

Ex Approvals

Approval details

UL Recognized		http://database.ul.com/cgi-bin/XYV/template/LISEXT/1FRAME/index.htm	FILE E 118976
Nominal voltage UN	30 V		

Flush-type connector - SACC-CI-M12MS-8CON-L90 SCO - 1436987

Approvals

Nominal current I _N	2 A
mm ² /AWG/kcmil	24

EAC		B.01687
-----	--	---------

Accessories

Accessories

Panel mounting base

Housing screw connection - SACC-M12-SCO PLUG - 1551493



M12 SPEEDCON housing screw connection for M12 male inserts, with O-ring, for all SPEEDCON-capable THR and wave soldering contact carriers

Housing screw connection - SACC-DSIV-M12-PLUG - 1416145



Housing screw connection with M12 standard thread, with O-ring, for the two-piece straight M12 THR contact carrier and for the two-piece angled M12 contact carrier

Housing screw connection - SACC-M12-SCO PLUG L90 - 1436709



M12-SPEEDCON housing screw connection for M12 male inserts, with flat gasket, for all Speedcon-compatible THR and wave soldering contact carriers

Housing screw connection - SACC-BP-M-M12/M15-6-THR - 1413997



Housing screw connection, Plug, M12, Rear mounting, M15 x 1

Flush-type connector - SACC-CI-M12MS-8CON-L90 SCO - 1436987

Accessories

Housing screw connection - SACC-BP-M-M12/M15-7-THR - 1413996



Housing screw connection, Plug, M12, Rear mounting, M15 x 1

Housing screw connection - SACC-BP-M-M12/M15-6-THR SCO - 1413999



M12 SPEEDCON housing screw connection for M12 male inserts, with O-ring, for all SPEEDCON-capable THR and wave soldering contact carriers

Housing screw connection - SACC-BP-M-M12/M15-7-THR SCO - 1413998



Housing screw connection, Plug, M12-SPEEDCON, Rear mounting, M15 x 1

Housing screw connection - SACC-M12 PLUG PRESS - 1437892



M12 pin, housing screw connection, press-in version, for all Speedcon-compatible THR and wave soldering contact carriers

Housing screw connection - SACC-DSIV-M12-PLUG-9 THR - 1417984



M12 pin, front mounting THR with M14 screw fastening

Flush-type connector - SACC-CI-M12MS-8CON-L90 SCO - 1436987

Accessories

Housing screw connection - SACC-BP-M-M12-THR PP - 1027661



Housing screw connection, Plug, M12-Push-Pull, Rear mounting, THR- und Wellenlötkontakte

Housing screw connection - SACC-FP-M-M12-THR PP - 1027679



Housing screw connection, Plug, M12-Push-Pull, Front mounting, THR- und Wellenlötkontakte

Protective cap

Sealing cap - PROT-M12 FS - 1560251



M12 sealing cap for unoccupied M12 plugs of the sensor/actuator cable, flush-type plugs and I/O devices in the field

Sealing cap - PROT-M12 FS-M - 1430488



M12 metal sealing cap for unoccupied M12 plugs of the sensor/actuator cable, flush-type plugs and I/O devices in the field

Seal

Seal - SACC-DSIV-M12MS-SEAL - 1405751

O-ring 7.5 x 1 mm

Phoenix Contact 2021 © - all rights reserved
<http://www.phoenixcontact.com>

PHOENIX CONTACT GmbH & Co. KG
Flachmarktstr. 8
32825 Blomberg
Germany
Tel. +49 5235 300
Fax +49 5235 3 41200
<http://www.phoenixcontact.com>