



XBee Zigbee Cloud Kit

Getting Started Guide

Revision history—90001503

Revision	Date	Description
A	March 2016	Baseline release of this document. The XBee Zigbee Cloud Kit information formerly resided in the <i>XBee Gateway User Guide</i> . This new document is a standalone document for the XBee Zigbee Cloud Kit. Updated the descriptions of the following terms in Development board components : <ul style="list-style-type: none">■ Associated LED■ Commissioning button■ User0/TCP LED■ User1/On LED■ Buzzer
B	July 2018	<ul style="list-style-type: none">■ Rebranded the device images and fixed links.■ Added information from 90001398-88 (XBee Zigbee Cloud Kit Quick Start Guide).
C	January 2020	Added information about the unique password for the web interface.

Trademarks and copyright

Digi, Digi International, and the Digi logo are trademarks or registered trademarks in the United States and other countries worldwide. All other trademarks mentioned in this document are the property of their respective owners.

© 2020 Digi International Inc. All rights reserved.

Disclaimers

Information in this document is subject to change without notice and does not represent a commitment on the part of Digi International. Digi provides this document “as is,” without warranty of any kind, expressed or implied, including, but not limited to, the implied warranties of fitness or merchantability for a particular purpose. Digi may make improvements and/or changes in this manual or in the product(s) and/or the program(s) described in this manual at any time.

Warranty

To view product warranty information, go to the following website:

www.digi.com/howtobuy/terms

Send comments

Documentation feedback: To provide feedback on this document, send your comments to techcomm@digi.com.

Customer support

Digi Technical Support: Digi offers multiple technical support plans and service packages to help our customers get the most out of their Digi product. For information on Technical Support plans and pricing, contact us at +1 952.912.3444 or visit us at www.digi.com/support.

Contents

XBee Zigbee Cloud Kit Getting Started Guide

Digi Device Cloud and Digi Remote Manager	6
Additional services	6

Get started

Verify XBee Zigbee Cloud Kit components	8
Included equipment	8
Required additional equipment	10
Connect the XBee Gateway hardware	10
Connect the XBee module and development board hardware	11
Connect the XBee Gateway to the network	11
Connect to a Wi-Fi network	11
Connect to an Ethernet network	12
Create a Remote Manager account	12
Add your XBee Gateway to Remote Manager	13
Log onto the XBee Zigbee Cloud Kit web application	15

Hardware

Development board components	18
XBee Zigbee/Wi-Fi DIP switches on the XBee development board	24

View the device data

View device data and events in the log file for XBee Gateway	26
View device data from the XBee Gateway web interface	26
View device data from Remote Manager	30
Device data or third party dashboards	30

View and customize widgets and development board components

Interaction between widgets and the XBee Zigbee development board	31
Add and customize a progress bar widget	33
Configure a widget on the dashboard	34

Join your XBee node to the Gateway network

Create a Zigbee network	37
Discover XBee radios	37
Verify your radio has joined the correct network	38
Read XBee configuration	38
Get the PAN ID and other network parameters for the Zigbee network	39
Configure the PAN ID and additional network parameters	39

Configure Zigbee nodes with custom PAN ID	39
---	----

Create custom applications with the XBee Zigbee Cloud Kit

Create your own applications	42
XBee Zigbee Cloud Kit Examples	42
Connect your application to Remote Manager	42
Collaborate and share your story	43

Troubleshoot your XBee Zigbee Cloud Kit

XBee Gateway fails to connect	44
Potential cause	44
XBee Gateway fails to join the wireless network	44
Potential cause	44
XBee module fails to join the network	45
Potential cause	45
Potential cause	45
Potential cause	45
Potential cause	45
Potential cause	45
Development board changes are not reflected on the dashboard	46
Potential cause	46
Potential cause	46
Dashboard functions not working as expected	46
Potential cause	46
Potential cause	46
Data does not display the dashboard or Remote Manager	47
Potential cause	47

XBee Zigbee Cloud Kit Getting Started Guide

The Digi™ XBee® Zigbee® Cloud Kit application makes working with your XBee Gateway and XBee modules quick and easy. The XBee Zigbee Cloud Kit web application integrates with Remote Manager to enable two-way communication over the Internet, giving you remote control of your device wherever you are. This application also allows you to customize your dashboard widgets so that you can create your own connected device systems.

Zigbee is a wireless standard, from the Zigbee Alliance, that supports development of wireless IoT applications. The XBee Zigbee Cloud Kit provides the foundation you need to get started working with XBee devices using the Zigbee protocol, and build cloud-connected prototypes quickly.

This guide describes how to get started with your XBee Zigbee Cloud Kit. This guide is intended for a developer or programmer.

Digi Device Cloud and Digi Remote Manager

Note To serve our customers most effectively, Digi International Inc. is consolidating its cloud services, Digi Device Cloud and Digi Remote Manager®, under the Remote Manager name. This phased process does not affect device functionality or the functionality of the web services and other features. However, you will find instances of both Device Cloud and Digi Remote Manager in some documentation, firmware, and user interfaces.

Additional services

For information on where to obtain more of our XBee products, professional services, and access to the Digi online support forums, see the following links:

- To purchase more XBee Zigbee modules, go to the [XBee and Zigbee product](#) page.
- If you need help building your own application, go to www.digi.com and then select **Services**.
- When you are ready to upgrade your account, contact a Digi expert at www.digi.com/support.
- If you have any questions, visit the [Digi Forum](#).

Get started

Use the following sections to get started with the XBee Zigbee Cloud Kit:

1. [Verify XBee Zigbee Cloud Kit components](#)
2. [Connect the XBee Gateway hardware](#)
3. [Connect the XBee module and development board hardware](#)
4. [Connect the XBee Gateway to the network](#)
5. [Create a Remote Manager account](#). If you already have a Remote Manager account, you can skip this step.
6. [Add your XBee Gateway to Remote Manager](#)

The graphic below shows the flow of information between the XBee Zigbee Cloud Kit components.

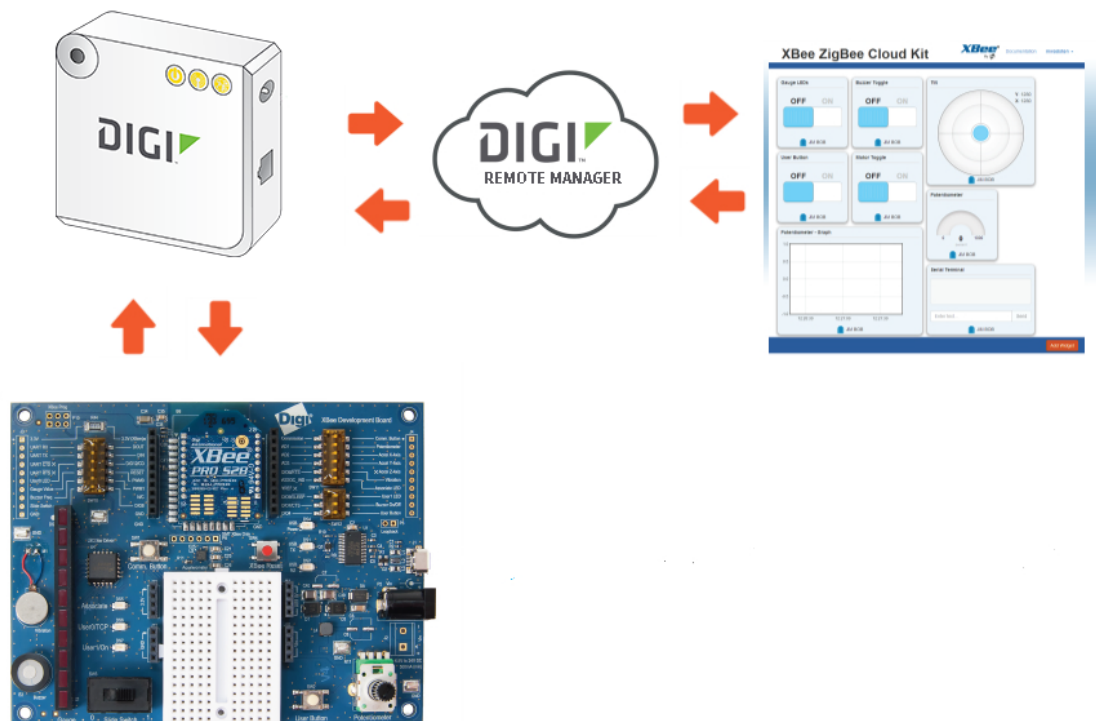

Additional features

You can also view device data, add widgets to the dashboard, create your own applications, and join an XBee node to the Xbee Gateway.

- [View the device data](#)
- [View and customize widgets and development board components](#)
- [Join your XBee node to the Gateway network](#)
- [Create custom applications with the XBee Zigbee Cloud Kit](#)



Need more help? Find additional product support at www.digi.com/support/ZigbeeCloudKit.

Verify XBee Zigbee Cloud Kit components

Verify that you have all included equipment. If any item is missing or damaged, contact your supplier.

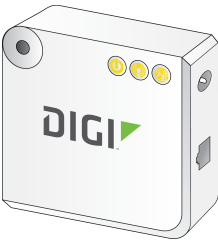
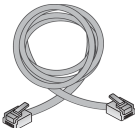
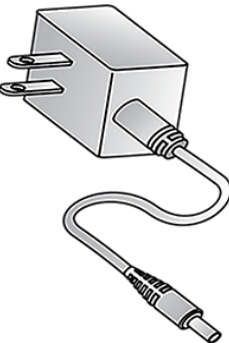
Included equipment

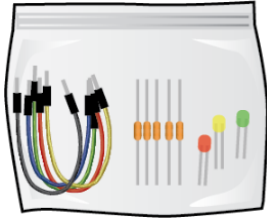
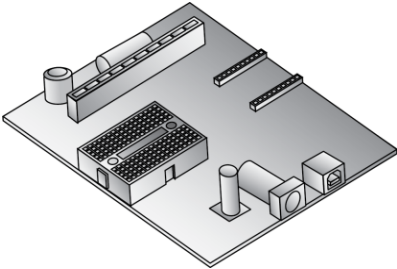
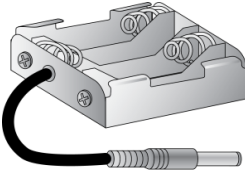
Part	Description
XBee Gateway Ethernet + Wi-Fi model	
Ethernet cable	
Power supply	

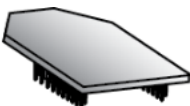
Part	Description
Loose components	
Development board	
Battery holder	
USB cable	
XBee module	

Required additional equipment

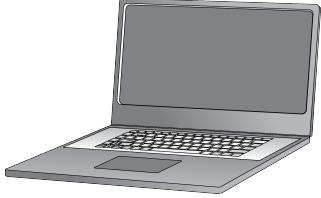
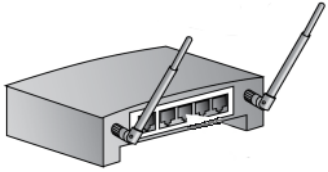
Part	Description
Personal computer	
Internet router	

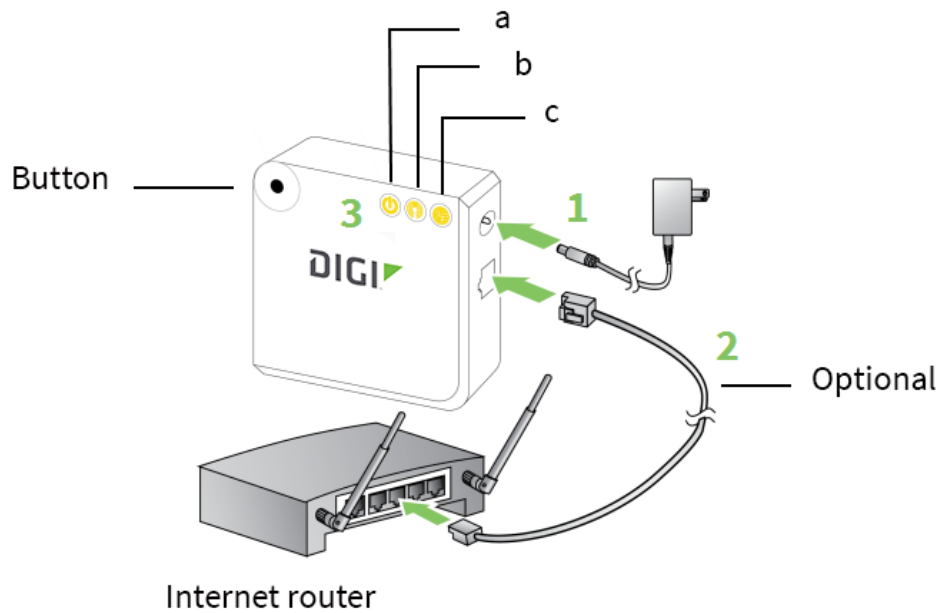

Connect the XBee Gateway hardware

1. Connect the power supply as shown in the following figure.



2. **Optional:** If you are using an Ethernet network connection in addition to Wi-Fi, connect one end of the Ethernet cable to your gateway and the other to a live Ethernet jack.

3. The start up sequence that occurs after power is applied is as follows:

- a.  The Power LED turns solid green.
- b.  The XBee LED turns blinking green when the XBee Gateway creates a Zigbee network.
- c.  The Network LED gradually turns solid green when the XBee Gateway connects to Remote Manager.

Connect the XBee module and development board hardware

1. Place the XBee module onto the development board, seating the pins on the connectors noted in the diagram.
2. Connect one end of the USB cable to the development board and the other end to your computer.
3. Locate the **Associate** LED on the development board. The **Associate** LED blinks green when the XBee module joins a Zigbee network.

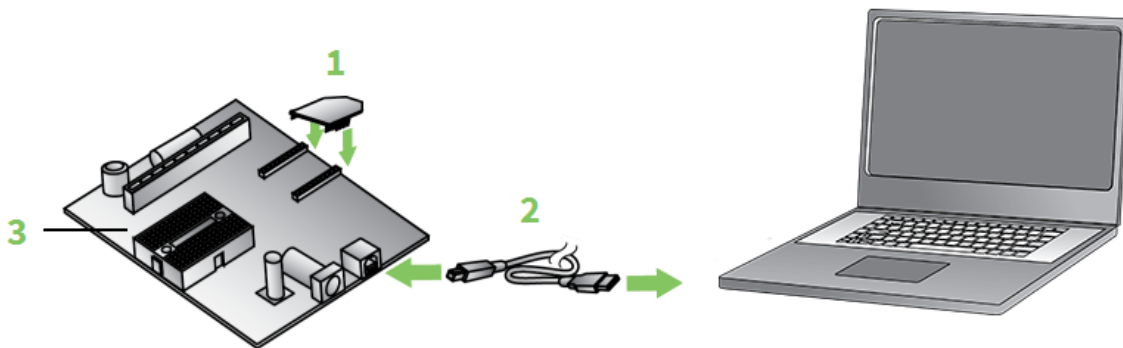

Note For more information on LED states, see the *Associate LED* section in [Development board components](#).

Connect the XBee Gateway to the network

This section explains how to connect the XBee Gateway to the network. You can connect to Wi-Fi or an ethernet network.

Connect to a Wi-Fi network

Before you begin, check with your network administrator on the Wi-Fi security mode and associated parameters for your network, including any passphrase or key used to connect to your Wi-Fi access

point. For example, ensure that you have the SSID, the security mode, the passphrase or key, and any other required parameters.

1. Power on and log in to your computer.
2. Press the button on your XBee Gateway once to enable Access Point mode. This Access Point mode is active for **five minutes**.

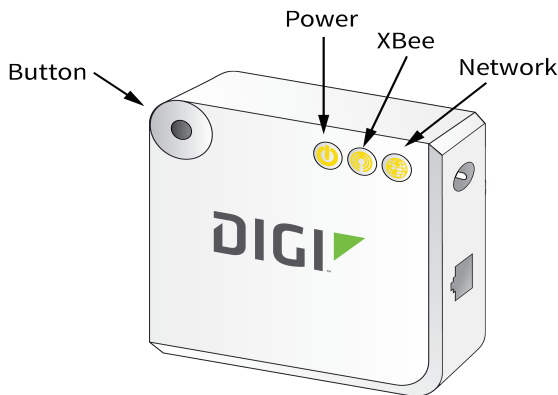

3. From the list of Wi-Fi network connections on your computer, connect your computer to the Wi-Fi network named **xbgw-xx:xx:xx:xx:xx:xx**, where **xx:xx:xx:xx:xx:xx** is the serial number of the gateway.
4. Once you are connected to the Wi-Fi network, open a web browser and enter the URL of the XBee Gateway: **http://192.168.100.1**. This opens the XBee Gateway web interface.
5. Log in to the web interface using the default user name and password. If these defaults do not work, the password may have been updated. Contact your system administrator for help.
 - **User name: python**
 - **Password:** The unique, default password is printed on the device label. If the password is not on the device label, the default password is **dbps**.
6. From the XBee Gateway web interface, go to **Configuration > Wireless Network**.
7. On the **Wireless Network Configuration** page, click **Run Wizard** and follow the prompts to configure your device. See the [XBee Gateway User Guide](#) for more information.
8. Restore the Wi-Fi network on your computer to its previous connection.

Connect to an Ethernet network

Your XBee Gateway automatically connects to the Ethernet network when a DHCP server is available to assign an IP address to the XBee Gateway and no firewalls block outgoing traffic to ports **3197** and **3199**.

If the Ethernet network does not come up, see [Troubleshoot your XBee Zigbee Cloud Kit](#).

Create a Remote Manager account

To use the features of the XBee Zigbee Cloud Kit web application, you must have a Remote Manager account.

To create and access a free Remote Manager account:

1. Sign in to [Remote Manager](#).
2. Click **Sign up**. The account information page appears.
3. Complete the form to create your account. If you need help see the [Create a Remote Manager account](#) section in the [Remote Manager User Guide](#).

Add your XBee Gateway to Remote Manager

You can add your XBee Gateway to Remote Manager from the XBee Gateway web interface.

1. Access the XBee Gateway web interface by entering the URL of the XBee Gateway:
http://192.168.100.1. The XBee Gateway web interface opens.
2. Log in to the web interface using the defaults. If the defaults do not work, the user name and password may have been updated. Contact your system administrator for help.
 - **User name:** `python`
 - **Password:** The unique, default password is printed on the device label. If the password is not on the device label, the default password is `dbps`.
3. **Optional:** Select a layout for the dashboard from the **Layout** menu. A layout is an arrangement of the widgets in the dashboard.
 - **Cloud Kit:** The default layout is **Cloud Kit**, and is recommended for new XBee Gateway users. This layout includes several widgets that exercise key hardware features of the XBee development board.
 - **Empty:** The **Empty** layout creates an empty dashboard and is recommended for advanced users familiar with the dashboard who want to create a custom layout.
4. Click **Add New Device**. The **Add a New Gateway to your Account** page appears.
5. Type the serial number and a name or description for your XBee Gateway. You can find the serial number on the label attached to XBee Gateway, as shown below.



6. Click **Add Device** to add XBee Gateway to your Remote Manager account. The serial number for the XBee Gateway appears in the **XBee Gateway** field.
7. On the **Dashboard Creation** page, choose the serial number of your XBee RF module on the XBee development board from the **XBee Module** drop-down list. The serial number is located on the back of your XBee RF module.

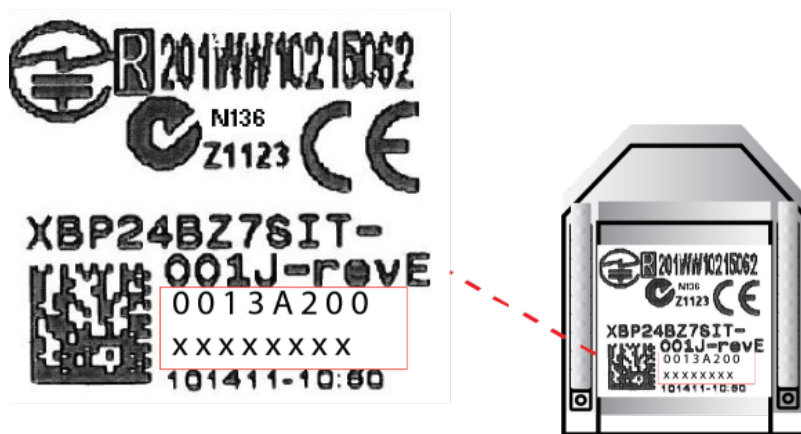

Tip If you don't see your device in the **XBee Module** drop-down list, click the link **Don't see your XBee?** to locate the device and see [Join your XBee node to the Gateway network](#) for more detailed troubleshooting instructions.

The application checks the XBee module's configuration to make sure it can communicate with XBee Gateway.

8. Add the XBee RF module on the XBee development board to Remote Manager. Your XBee Gateway device hardware must be configured to properly work with the XBee Zigbee Cloud Kit web application. When prompted, choose one of the following options to apply the kit configuration:
 - **Yes (recommended)**: Configures your device hardware to work with the XBee Zigbee Cloud Kit web application.
 - **Skip**: Leaves the configuration of your device hardware as-is. If you choose this option, some data from the device hardware may not appear properly on the dashboard widgets.
9. A green check mark appears when the device is successfully configured.

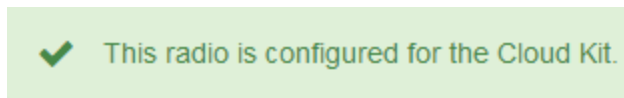

10. Click **Create Dashboard**. The dashboard appears.

Log onto the XBee Zigbee Cloud Kit web application

You use the XBee Zigbee Cloud Kit web application to manage the XBee Zigbee Cloud Kit data.

Note The web application and Remote Manager use the same user name and password, so you must create a Remote Manager account before you can log in to the web application. See [Create a Remote Manager account](#).

To log onto the XBee Zigbee Cloud Kit web application:

1. From a web browser, go to the [XBee Zigbee Cloud Kit login](#) page.

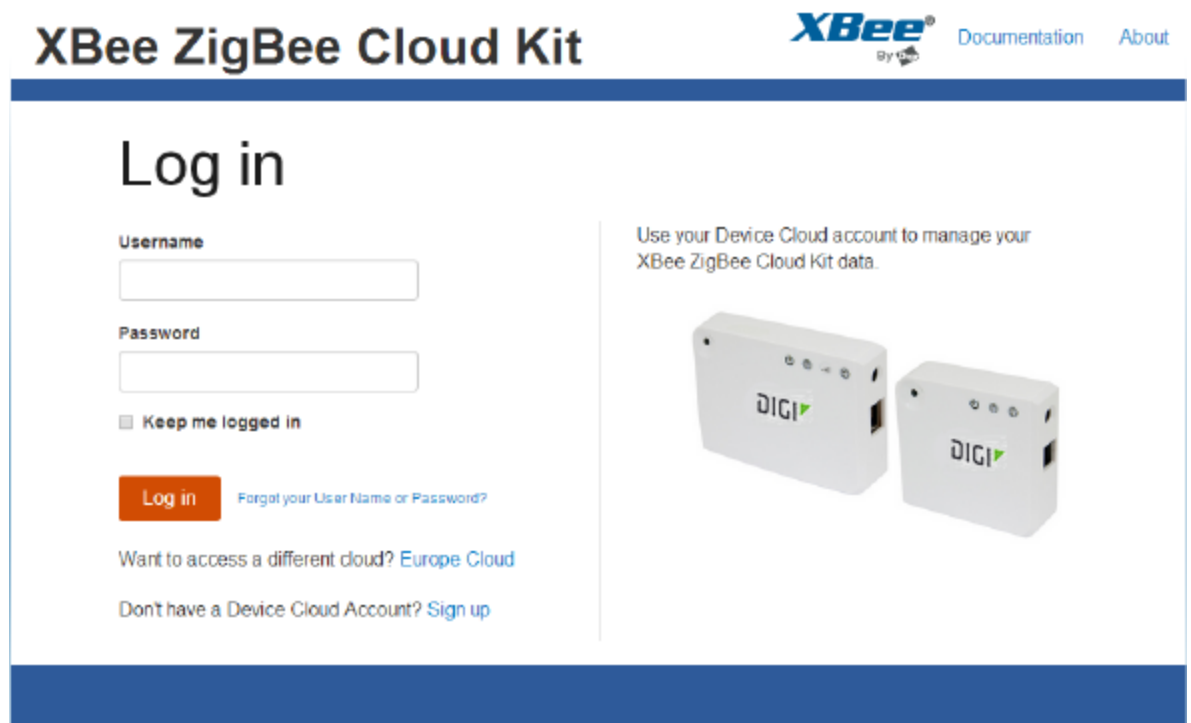

2. Type the user name and password that you created in [Create a Remote Manager account](#).
3. Click **Log in**.

Hardware

Development board components	18
XBee Zigbee/Wi-Fi DIP switches on the XBee development board	24

Development board components

This section contains information about the components on the development board.

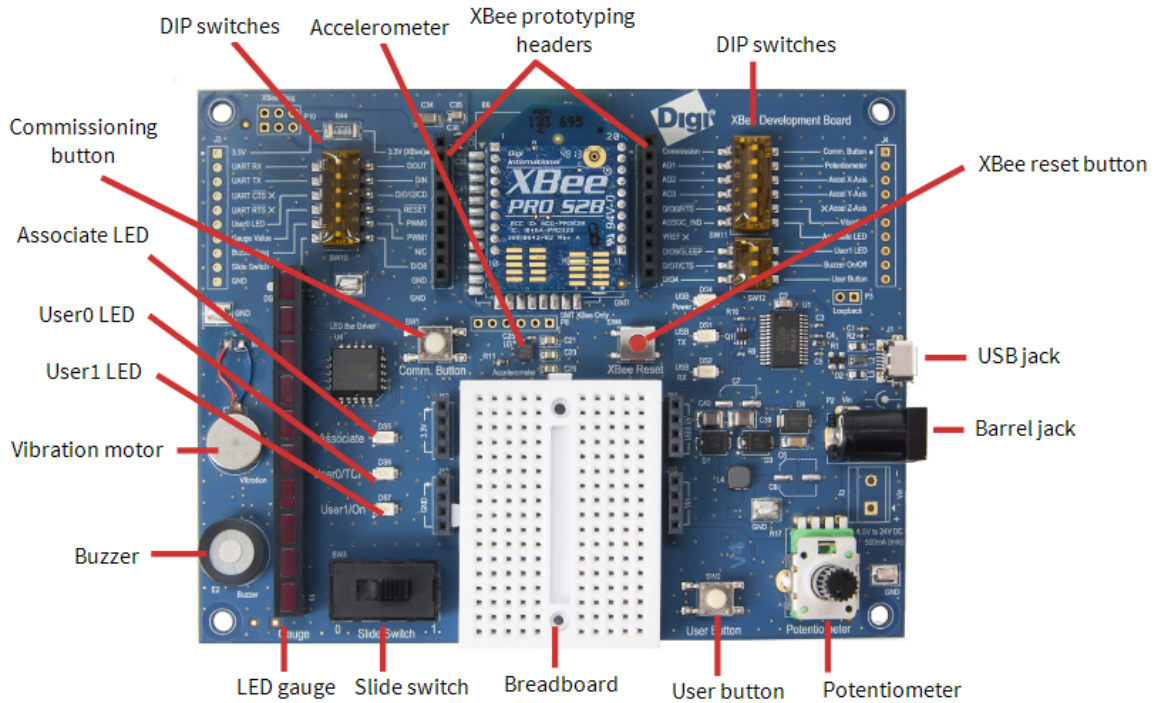

The table below contains an alphabetized list of the components on the board.

Item	Description
Accelerometer	The accelerometer drives the Tilt widget. You can control the accelerometer through the XBee Zigbee dashboard.

Item	Description																											
<p>Associate LED</p>	<p>The Associate pin (pin 15) provides an indication of the device's sleep status and diagnostic information.</p> <p>To enable the associate LED functionality, set the D5 command to 1; it is enabled by default. If enabled, the Associate pin is configured as an output. This section describes how the pin behaves.</p> <p>The Associate pin indicates the synchronization status of a sleep compatible XBee Gateway. If a device is not sleep compatible, the pin functions as a power indicator.</p> <p>Use the LT command to override the blink rate of the Associate pin. If you set LT to 0, the device uses the default blink time: 500 ms for a sleep coordinator, 250 ms otherwise.</p> <p>The following table describes the Associate LED functionality.</p> <table border="1" data-bbox="657 850 1416 1696"> <thead> <tr> <th data-bbox="657 850 743 930">Sleep mode</th> <th data-bbox="743 850 906 930">LED Status</th> <th data-bbox="906 850 1416 930">Meaning</th> </tr> </thead> <tbody> <tr> <td data-bbox="657 930 743 1010">0</td> <td data-bbox="743 930 906 1010">On, blinking</td> <td data-bbox="906 930 1416 1010">The device has power and is operating properly.</td> </tr> <tr> <td data-bbox="657 1010 743 1066">1, 4, 5</td> <td data-bbox="743 1010 906 1066">Off</td> <td data-bbox="906 1010 1416 1066">The device is in a low power mode.</td> </tr> <tr> <td data-bbox="657 1066 743 1146">1, 4, 5</td> <td data-bbox="743 1066 906 1146">On, blinking</td> <td data-bbox="906 1066 1416 1146">The device has power, is awake and is operating properly.</td> </tr> <tr> <td data-bbox="657 1146 743 1262">7</td> <td data-bbox="743 1146 906 1262">On, solid</td> <td data-bbox="906 1146 1416 1262">The network is asleep, or the device has not synchronized with the network, or has lost synchronization with the network.</td> </tr> <tr> <td data-bbox="657 1262 743 1409">7, 8</td> <td data-bbox="743 1262 906 1409">On, slow blinking (500 ms blink time)</td> <td data-bbox="906 1262 1416 1409">The device is acting as the network sleep coordinator and is operating properly.</td> </tr> <tr> <td data-bbox="657 1409 743 1556">7, 8</td> <td data-bbox="743 1409 906 1556">On, fast blinking (250 ms blink time)</td> <td data-bbox="906 1409 1416 1556">The device is properly synchronized with the network.</td> </tr> <tr> <td data-bbox="657 1556 743 1612">8</td> <td data-bbox="743 1556 906 1612">Off</td> <td data-bbox="906 1556 1416 1612">The device is in a low power mode.</td> </tr> <tr> <td data-bbox="657 1612 743 1692">8</td> <td data-bbox="743 1612 906 1692">On, solid</td> <td data-bbox="906 1612 1416 1692">The device has not synchronized or has lost synchronization with the network.</td> </tr> </tbody> </table>	Sleep mode	LED Status	Meaning	0	On, blinking	The device has power and is operating properly.	1, 4, 5	Off	The device is in a low power mode.	1, 4, 5	On, blinking	The device has power, is awake and is operating properly.	7	On, solid	The network is asleep, or the device has not synchronized with the network, or has lost synchronization with the network.	7, 8	On, slow blinking (500 ms blink time)	The device is acting as the network sleep coordinator and is operating properly.	7, 8	On, fast blinking (250 ms blink time)	The device is properly synchronized with the network.	8	Off	The device is in a low power mode.	8	On, solid	The device has not synchronized or has lost synchronization with the network.
Sleep mode	LED Status	Meaning																										
0	On, blinking	The device has power and is operating properly.																										
1, 4, 5	Off	The device is in a low power mode.																										
1, 4, 5	On, blinking	The device has power, is awake and is operating properly.																										
7	On, solid	The network is asleep, or the device has not synchronized with the network, or has lost synchronization with the network.																										
7, 8	On, slow blinking (500 ms blink time)	The device is acting as the network sleep coordinator and is operating properly.																										
7, 8	On, fast blinking (250 ms blink time)	The device is properly synchronized with the network.																										
8	Off	The device is in a low power mode.																										
8	On, solid	The device has not synchronized or has lost synchronization with the network.																										

Item	Description
Barrel jack	Accepts 4.5 V to 24 V. You can use the barrel jack with the battery pack provided with the kit.
Breadboard	
Buzzer	You can use the buzzer as an alarm to indicate trouble. You can control the buzzer through the XBee Zigbee dashboard. Use the buzzer toggle widget to turn the buzzer on/off.

Item	Description									
<p>Commissioning button</p>	<p>The XBee Zigbee development board supports a set of commissioning and LED functions to help you deploy and commission devices. These functions include the Commissioning button definitions and the associated LED functions.</p> <p>Definitions To enable the Commissioning button functionality on pin 20, set the DO command to 1. The functionality is enabled by default.</p> <p>You must perform multiple button presses within two seconds.</p> <p>The following table provides the button definitions.</p> <table border="1" data-bbox="657 726 1419 1503"> <thead> <tr> <th data-bbox="657 726 771 869">Button presses</th> <th data-bbox="771 726 954 869">Sleep configuration and sync status</th> <th data-bbox="954 726 1419 869">Action</th> </tr> </thead> <tbody> <tr> <td data-bbox="657 869 771 1171">1</td> <td data-bbox="771 869 954 1171">Not configured for sleep</td> <td data-bbox="954 869 1419 1171">Immediately sends a Node Identification broadcast transmission. All devices that receive this transmission blink their Associate LED rapidly for one second. All devices in API operating mode that receive this transmission send a Node Identification Indicator frame (0x95) out their UART.</td> </tr> <tr> <td data-bbox="657 1171 771 1503">1</td> <td data-bbox="771 1171 954 1503">Configured for asynchronous sleep</td> <td data-bbox="954 1171 1419 1503">Wakes the device for 30 seconds. Immediately sends a Node Identification broadcast transmission. All devices that receive this transmission blink their Associate LED rapidly for one second. All devices in API operating mode that receive this transmission send a Node Identification Indicator frame (0x95) out their UART.</td> </tr> </tbody> </table>	Button presses	Sleep configuration and sync status	Action	1	Not configured for sleep	Immediately sends a Node Identification broadcast transmission. All devices that receive this transmission blink their Associate LED rapidly for one second. All devices in API operating mode that receive this transmission send a Node Identification Indicator frame (0x95) out their UART.	1	Configured for asynchronous sleep	Wakes the device for 30 seconds. Immediately sends a Node Identification broadcast transmission. All devices that receive this transmission blink their Associate LED rapidly for one second. All devices in API operating mode that receive this transmission send a Node Identification Indicator frame (0x95) out their UART.
Button presses	Sleep configuration and sync status	Action								
1	Not configured for sleep	Immediately sends a Node Identification broadcast transmission. All devices that receive this transmission blink their Associate LED rapidly for one second. All devices in API operating mode that receive this transmission send a Node Identification Indicator frame (0x95) out their UART.								
1	Configured for asynchronous sleep	Wakes the device for 30 seconds. Immediately sends a Node Identification broadcast transmission. All devices that receive this transmission blink their Associate LED rapidly for one second. All devices in API operating mode that receive this transmission send a Node Identification Indicator frame (0x95) out their UART.								

Item	Description					
	<table border="1"> <thead> <tr> <th data-bbox="654 289 769 436">Button presses</th> <th data-bbox="769 289 954 436">Sleep configuration and sync status</th> <th data-bbox="954 289 1419 436">Action</th> </tr> </thead> </table>	Button presses	Sleep configuration and sync status	Action		
Button presses	Sleep configuration and sync status	Action				
	1	Configured for synchronous sleep	Wakes the module for 30 seconds or until the synchronized network goes to sleep. Queues a Node Identification broadcast transmission that it sends at the beginning of the next network wake cycle. All devices that receive this transmission blink their Associate LED rapidly for one second. All devices in API operating mode that receive this transmission send a Node Identification Indicator frame (0x95) out their UART.			
	2	Not configured for synchronous sleep	No effect.			
	2	Configured for synchronous sleep	Causes a node configured with sleeping router nomination enabled to immediately nominate itself as the network sleep coordinator. For more information, see the SO (Sleep Options) command for your XBee module.			
	4	Any	Sends an RE command to restore device parameters to default values.			
	<p>Use the Commissioning button Use the CB command to simulate button presses in software. Send CB with a parameter set to the number of button presses to perform. For example, if you send ATCB1, the device performs the action(s) associated with a single button press.</p> <p>The Node Identification Indicator (0x95) frame is similar to the Remote Command Response (0x97) frame—it contains the device’s address, node identifier string (NI command), and other relevant data. All devices in API operating mode that receive the Node Identification Indicator frame send it out their UART as a Node Identification Indicator frame.</p>					

Item	Description
	If you enable the Commissioning button during sleep, it increases the sleeping current draw, especially in Asynchronous pin sleep (SM = 1) mode. When asleep, hold down the Commissioning button for up to two seconds to wake the device from sleep, then issue the two or four button presses.
Diagnostics support	The Associate pin works with the Commissioning button to provide additional diagnostic behaviors to aid in deploying and testing a network. If you press the Commissioning button once, XBee Gateway transmits a broadcast Node Identification Indicator (0x95) frame at the beginning of the next wake cycle if the device is sleep compatible, or immediately if the device is not sleep compatible. If you enable the Associate LED functionality using the D5 command, a device that receives this transmission blinks its Associate pin rapidly for one second.
DIP switches (back or underside of board)	Set the board for use with XBee Zigbee or XBee Wi-Fi modules. For more information, see XBee Zigbee/Wi-Fi DIP switches on the XBee development board .
DIP switches (top of board)	Allows components on the development board to be disconnected from the XBee Zigbee module. If the switch is away from the XBee Zigbee module, the XBee pin is connected to that built-in widget on the XBee Zigbee dashboard. If the switch is towards the XBee, the XBee pin is disconnected from that component. <hr/> Note When you use loose components or do advanced prototyping, you may need to disconnect the built-in component from the XBee pin. <hr/>
LED gauge	Controlled through the XBee Zigbee dashboard, the LED gauge can be toggled on or off.
Potentiometer	You can choose to report the data from the potentiometer to the XBee Zigbee dashboard as a speedometer gauge, progress bar, or a graph. You can control the potentiometer by turning the adjustable knob left or right.
Push button	The state of the push button appears on the XBee Zigbee dashboard. The push button only displays ON when you are actively pushing the button.
Slide switch	The state of the slide switch is indicated on the XBee Zigbee dashboard. Similar to a light switch, it stays either on or off.
USB jack	You can use the USB jack to power the development board. The USB jack also provides serial port access to the XBee Zigbee for configuration or sending and receiving data to and from Remote Manager.

Item	Description
User0/TCP LED	You can control the User0/TCP LED through the XBee Zigbee dashboard.
User1/On LED	You can control the User1/On LED through the XBee Zigbee dashboard.
Vibration motor	The vibration motor indicates a change in status. You can control the vibration motor through the XBee Zigbee dashboard.
XBee prototyping headers	Allows connection to all pins of the XBee Zigbee. Use the prototyping headers to connect to your own circuits including those using the loose components that came with your kit.
XBee reset button	The XBee reset button is connected to the reset pin of the XBee Zigbee.

XBee Zigbee/Wi-Fi DIP switches on the XBee development board

The XBee development board in the XBee Zigbee Cloud Kit has three DIP switches on the back of the board. These switches set the board for use with XBee Zigbee or XBee Wi-Fi modules. A table on the board shows the proper switch settings for XBee Zigbee and XBee Wi-Fi modules and is shown in the following figure. These switches are set at the factory for the XBee Zigbee Cloud Kit. In the event the switches are changed away from the proper settings for XBee ZigBee modules, you may experience the following symptoms when working with the development board and XBee Zigbee Cloud Kit web application dashboard:

- The buzzer will not work as expected.
- None of the analog components will work or display properly on the dashboard.

The following figure shows the proper DIP switch settings for the XBee Zigbee Cloud Kit for use with XBee Zigbee modules:

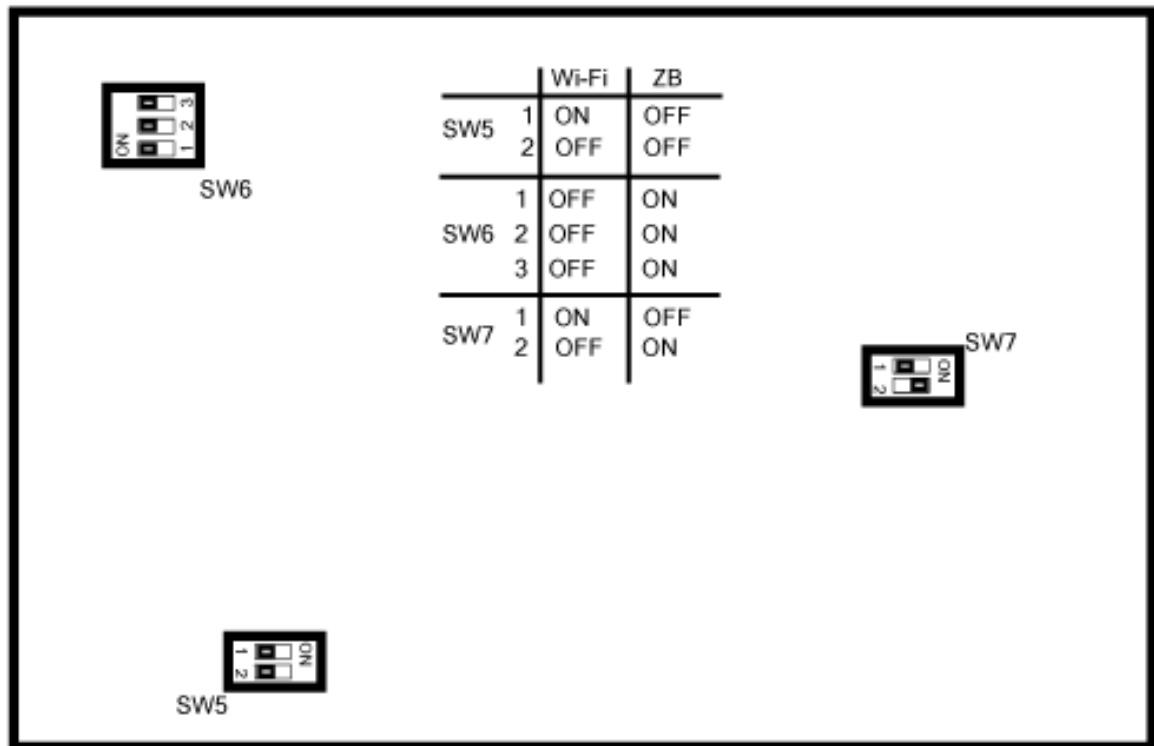

View the device data

The XBee Zigbee Cloud Kit allows you to view and customize widgets for built-in components on the development board.

View device data and events in the log file for XBee Gateway

The XBee Gateway Python application resides on XBee Zigbee. Its key functions include connecting your XBee modules to Remote Manager, enabling uploads of data to Remote Manager, and receiving remote text and commands. The XBee Gateway Python application is installed in your XBee Zigbee device and automatically starts when the gateway initializes. When you use the XBee Gateway Python application, device data for your XBee network is captured in the form of events in one of the XBee Gateway log files, **python.log**. Events that may be of note include:

- Serial or I/O data arriving from an XBee node on your RF network
- An RCI command received from Remote Manager
- Attempts to upload data to Data Streams in Remote Manager
- Errors and warnings during execution for debugging and diagnostics

The **python.log** file may be accessed through the XBee Gateway web interface or from Remote Manager.

See [XBee Gateway application and Python](#) in the [XBee Gateway User Guide](#) for more information.

View device data from the XBee Gateway web interface

To access the python.log file from the XBee Gateway web interface:

1. Access the web interface and log using the default user name and password. If these defaults do not work, the password may have been updated. Contact your system administrator for help.
 - **User name:** **python**
 - **Password:** The unique, default password is printed on the device label. If the password is not on the device label, the default password is **dbps**.
2. Click **System Log** under Administration.

- These lines show a digital I/O reading received by the XBee Gateway application:

```
Aug  4 19:47:38 (none) local7.info pylog: 2014-08-04 19:47:38,524
DEBUG xbgw.xbee.manager: Received frame from ('
[00:13:A2:00:40:9F:6F:CB]!', 0xe8, 0xc105, 0x92, 0x1, 0x0)
Aug  4 19:47:38 (none) local7.info pylog: 2014-08-04 19:47:38,542
DEBUG xbgw.xbee.manager: Processing IO sample from pin DI012
Aug  4 19:47:38 (none) local7.info pylog: 2014-08-04 19:47:38,554
DEBUG xbgw.xbee.manager: Digital reading: 0
```

- These lines show an analog I/O reading received by the XBee Gateway application:

```
Aug  4 19:47:38 (none) local7.info pylog: 2014-08-04 19:47:38,610
DEBUG xbgw.xbee.manager: Processing IO sample from pin AD3
Aug  4 19:47:38 (none) local7.info pylog: 2014-08-04 19:47:38,620
DEBUG xbgw.xbee.manager: Analog data: 780
```

- These lines show six data points uploaded to Remote Manager:

```

Aug  4 19:47:44 (none) local7.info pylog: 2014-08-04 19:47:44,207 INFO
xbgw.reporting.device_cloud: Uploading data to DataPoint/upload.csv
Aug  4 19:47:44 (none) local7.info pylog: 2014-08-04 19:47:44,220
DEBUG xbgw.reporting.device_cloud: stream_id: xbee.analog/
[00:13:A2:00:40:9F:6F:CB]!/AD1
Aug  4 19:47:44 (none) local7.info pylog: 2014-08-04 19:47:44,230
DEBUG xbgw.reporting.device_cloud: data: ('xbee.analog/
[00:13:A2:00:40:9F:6F:CB]!/AD1', 426, {})
Aug  4 19:47:44 (none) local7.info pylog: 2014-08-04 19:47:44,238
DEBUG xbgw.reporting.device_cloud: stream_id: xbee.digitalIn/
[00:13:A2:00:40:9F:6F:CB]!/DI04
Aug  4 19:47:44 (none) local7.info pylog: 2014-08-04 19:47:44,245
DEBUG xbgw.reporting.device_cloud: data: ('xbee.digitalIn/
[00:13:A2:00:40:9F:6F:CB]!/DI04', True, {})
Aug  4 19:47:44 (none) local7.info pylog: 2014-08-04 19:47:44,263
DEBUG xbgw.reporting.device_cloud: stream_id: xbee.digitalIn/
[00:13:A2:00:40:9F:6F:CB]!/DI06
Aug  4 19:47:44 (none) local7.info pylog: 2014-08-04 19:47:44,280
DEBUG xbgw.reporting.device_cloud: data: ('xbee.digitalIn/
[00:13:A2:00:40:9F:6F:CB]!/DI06', True, {})
Aug  4 19:47:44 (none) local7.info pylog: 2014-08-04 19:47:44,288
DEBUG xbgw.reporting.device_cloud: stream_id: xbee.digitalIn/
[00:13:A2:00:40:9F:6F:CB]!/DI07
Aug  4 19:47:44 (none) local7.info pylog: 2014-08-04 19:47:44,300
DEBUG xbgw.reporting.device_cloud: data: ('xbee.digitalIn/
[00:13:A2:00:40:9F:6F:CB]!/DI07', False, {})
Aug  4 19:47:44 (none) local7.info pylog: 2014-08-04 19:47:44,308
DEBUG xbgw.reporting.device_cloud: stream_id: xbee.digitalIn/
[00:13:A2:00:40:9F:6F:CB]!/DI00
Aug  4 19:47:44 (none) local7.info pylog: 2014-08-04 19:47:44,324
DEBUG xbgw.reporting.device_cloud: data: ('xbee.digitalIn/
[00:13:A2:00:40:9F:6F:CB]!/DI00', True, {})
Aug  4 19:47:44 (none) local7.info pylog: 2014-08-04 19:47:44,332
DEBUG xbgw.reporting.device_cloud: stream_id: xbee.analog/
[00:13:A2:00:40:9F:6F:CB]!/AD2
Aug  4 19:47:44 (none) local7.info pylog: 2014-08-04 19:47:44,337
DEBUG xbgw.reporting.device_cloud: data: ('xbee.analog/
[00:13:A2:00:40:9F:6F:CB]!/AD2', 780, {})
Aug  4 19:47:44 (none) local7.info pylog: 2014-08-04 19:47:44,354 INFO
xbgw.reporting.device_cloud: Upload contains 6 datapoints

```

```
Aug  4 19:47:44 (none) local7.info syslog: 2014-08-04 19:47:44,526 INFO
xbgw.reporting.device_cloud: Upload successful
```

View device data from Remote Manager

The system log is a file maintained in the file system of the device. To retrieve the python.log file from Remote Manager, use **File Management** capabilities in Remote Manager. See the [Digi Remote Manager User Guide](#) if you need help.

Device data or third party dashboards

The XBee Zigbee Cloud Kit web application is available for viewing device data on Remote Manager. If you want to create your own dashboard or use a third-party dashboard instead, refer to the [Digi Remote Manager Programmer Guide](#) for a description of the Web Services API.

View and customize widgets and development board components

The XBee Zigbee Cloud Kit allows you to view and customize widgets for built-in components on the development board. The widgets represent elements of the XBee module on your device hardware. The data for those elements is represented in graphical form as a dashboard in the XBee Zigbee Cloud Kit web application.

By default, your dashboard displays the widgets for the components in the XBee Zigbee Cloud Kit.

The following topics explain how to add and configure widgets on the development board.

- [Interaction between widgets and the XBee Zigbee development board](#)
- [Add and customize a progress bar widget](#)
- [Configure a widget on the dashboard](#)

Interaction between widgets and the XBee Zigbee development board

The following example shows how the dashboard for the XBee Zigbee Cloud Kit web application and your development board interact with one another. You can try widget functions on the development board and observe the results using the XBee Zigbee Cloud Kit web application.

This example assumes you are signed in to the XBee Zigbee Cloud Kit web application. For instructions, see [Log onto the XBee Zigbee Cloud Kit web application](#).

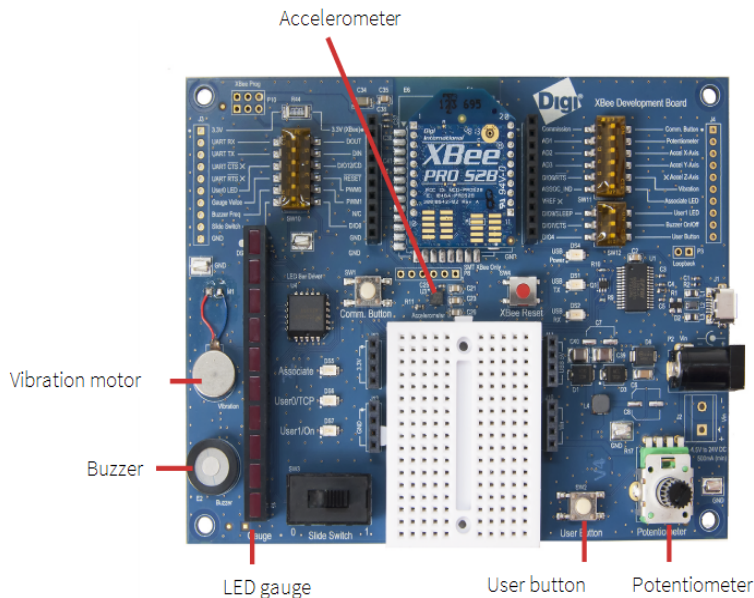

Note For information about the development board components, see [Development board components](#).

1. On the development board, press and hold the **User Button**. Observe how the **User Button** widget on the dashboard changes from OFF to ON.
2. On the dashboard, turn on the **Gauge LEDs**. Observe how the **Gauge LEDs** on the development board illuminate.
3. On the development board, turn the knob on the **Potentiometer** left or right and wait a few seconds. Observe how the Potentiometer gauge and Potentiometer graph on the dashboard change.

Note The display on the dashboard relative to action on the board is dependent on the sampling rate on the XBee and potential throttling of data by Remote Manager. If you notice that changes made on the development board are not reflected on the dashboard, refresh the web page and try again.

4. Exercise the serial terminal application. Use a serial terminal application such as [XCTU](#) to enter serial data. This example uses XCTU though you can use other serial terminal applications, such as HyperTerm or CoolTerm, as well.
 - a. In XCTU, click the **Consoles working mode**  tab. The Console log window appears.
 - b. In the Serial Data widget, type some serial data; for example, type **Hello World!**

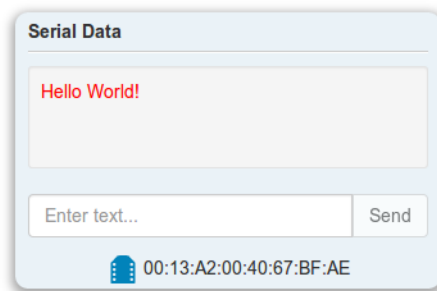

- c. The XCTU console displays the serial data in text and hexadecimal format; for example, type **Hello back?**

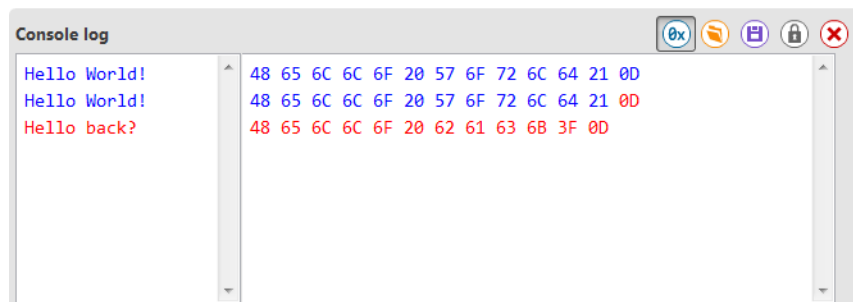

The Serial Data widget displays the serial data:

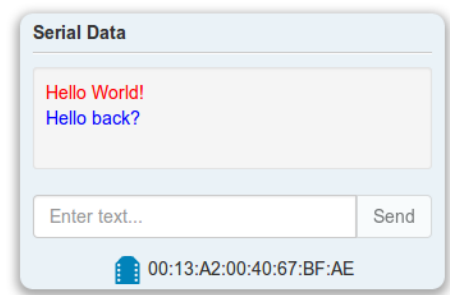

Add and customize a progress bar widget

There are a variety of widgets that you can use to customize your dashboard. The following example shows how to add a progress bar widget.

1. Click **Add Widget** located on the bottom-right corner of your XBee Zigbee dashboard.
2. Select the type of widget to create from the **Widget Type** drop-down list; for example, select **Bar Graph Widget (Vertical)**.
3. Type a description of your widget in the **Label** field; for example, type **Temperature**.
4. Select the XBee Gateway device ID to attach to the widget from the **Gateway** drop-down list.
5. Select the XBee module associated with the dashboard from the **XBee Module** drop-down list.
6. Select the input stream from the device that will be attached to the widget from the **Input Stream** drop-down list.

The rest of the settings are for advanced management of the widget. See [Configure a widget on the dashboard](#) for more information on these settings.

7. Click **Save** to save your widget settings. The browser directs you to your XBee Zigbee dashboard where you can see the new progress bar widget; for example:

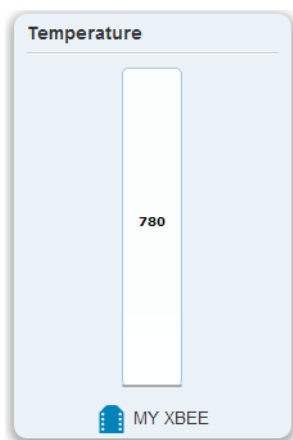

Configure a widget on the dashboard

To configure the widgets on your dashboard, hover over the widget header, and click the settings  icon that appears in the upper-right corner of your device's input output (I/O) channel icon. On the widget settings page, you can edit and customize the display of each widget. The following table briefly describes each widget setting and how it affects the widget.

Widget Setting	Description
Input Stream	Specifies the data stream that the widget subscribes to for data updates. Can be Digital (DIO#) or Analog (AD#). (The tilt indicator widget has X-Axis Stream and Y-Axis Stream settings; these are two copies of the Input Stream setting, renamed to clarify the use of the stream.)
Output Stream	Specifies the digital I/O pin (DIO#) on the XBee module to which the widget sends its output values.

Widget Setting	Description
Units	String label used in the widget to display the units for the values (for example, millivolts, decibels).
Timespan	The total timespan, in seconds, to display in the graph. For example, if the timespan is set to 90, the graph will show 90 seconds of data at a time.
X-axis tick size	The spacing, in seconds, between tick marks/lines drawn along the X-axis of the graph
Y-axis autoscale	When you select this check box, the Y-axis of the graph automatically scales to fit the data displayed. If you clear the check box, the minimum and maximum values default to the Y-axis min/max values.
Y-axis minimum/maximum	The minimum and maximum range on the graph's Y axis. You can use this setting if the Y-axis auto scale check box is cleared.
Low value/High value	This setting is available on the progress bar and gauge widgets. It specifies the low and high values for data within the progress bar or gauge. For example, you can set these values to display a data stream's values ranging from 100 to 1000.
Input Transform	<p>Allows incoming data to be processed with an expression for display. The transform field is implemented using the AngularJS <code>\$eval</code> function, and will only evaluate basic Angular expressions. For example, the stock potentiometer gauge widget uses <code>value/1023 * 100</code>. The following variables can access the input value:</p> <ul style="list-style-type: none"> ■ <code>value</code> ■ <code>val</code> ■ <code>input</code> ■ <code>x</code> <p>See Angular Expressions vs. JS Expressions for more information on Angular JS.</p>
Invert Values	When you select this check box, setting the switch to the On position sends the value 0 . Setting the switch to the Off position sends the value 1 . If you clear this check box, setting the switch to the On position sends 1 and setting the switch to the Off position sends 0 .
Read Only Switch	When you select this check box, the switch represents the data stream value last received from the server.

Widget Setting	Description
Add Carriage Returns	This setting is available on the serial data widget. Specifies whether to wrap serial data sent to the XBee module in carriage return characters first. This use of a carriage returns helps make the text more readable when printed out, displayed in the widget, or XCTU.
Check Radio Configuration button	Verifies that the XBee module's I/O configuration is appropriate for the selected input or output stream. (For example, if the Input Stream is set to DIO0, the Check Radio Configuration dialog verifies that D0 on the XBee module is set to act as a digital input.) Click this button to ensure that your XBee module is configured to work with your XBee Zigbee Cloud Kit.
Discover control (near XBee Module)	Provides available options for refreshing the list of XBee modules. The options include: <ul style="list-style-type: none"> ■ Fetch from Device Cloud: Gets a list of XBee modules using the Remote Manager XbeeCore web service. ■ Fetch from gateway (cached): Gets a list of XBee modules from the cached discovery list on XBee Gateway. ■ Fetch from gateway (clear device list): Clears the cached discovery list on XBee Gateway, performs a new discovery operation, and displays a new list of discovered XBee modules.

Join your XBee node to the Gateway network

If you do not see your XBee node in the list of devices in the XBee Zigbee Cloud Kit web application, your XBee node is not joined to the Gateway network started by XBee Zigbee. Use the following sections to join your node to your XBee Zigbee.

Note For many of the steps in this process, you must install and use XCTU. XCTU is a free, multi-platform application which enables developers to interact with Digi RF modules. If you do not have XCTU installed, go to www.digi.com/xctu to download and install XCTU.

Create a Zigbee network

You can verify that your XBee Zigbee module has successfully joined the Zigbee network started by the XBee Gateway device.

1. Make sure XBee Gateway is powered on.
2. Make sure the XBee Zigbee node is mounted on the development board and that the development board is powered on.
3. Open a web browser and type the URL of XBee Gateway: **http://192.168.100.1**. This will open the XBee Gateway web interface.
4. Log in to the web interface.
 - **User name:** The default user name is **python**. If that user name does not work, it may have been changed by your system administrator. Contact your system administrator for help.
 - **Password:** The unique, default password is printed on the device label. If the password is not on the device label, the default password is **dbps**. If these defaults do not work, the password may have been updated. Contact your system administrator for help.
5. Under **Configuration**, click **XBee Network**. The **XBee Configuration** page appears.
6. Under the **Remote XBee Devices** table, clear the **Clear list before discovery** check box and then click the **Discover XBee Devices** button. After a few seconds, the table displays your XBee Zigbee node.

Discover XBee radios

You must install XCTU on your computer. If you do not have XCTU installed, go to www.digi.com/xctu to download and install XCTU.

To discover the XBee radios attached to your computer:

1. Connect the XBee development board to your computer using a USB cable.
2. Open XCTU and add the XBee node that is connected to your computer to the list of radio modules.
3. Click the **Discover devices** . The **Discover radio devices** dialog appears.
4. Select the serial port(s) to scan from the list. If you know the serial port you can save time by selecting just that port. The discovery process attempts to identify radios on all selected ports.
5. Click **Next**.
6. Configure serial settings. The defaults are good for most radios and do not need to be changed in most environments.
7. Click **Finish**. The system performs the discovery process. This can take some time. All discovered devices appear upon completion.
8. Choose your radio(s) from the list.
9. Click **Add selected devices**.

The radios that you discovered now appear in the **Radio Modules** pane of the main XCTU application.

Verify your radio has joined the correct network

To verify that your radio has joined the correct network:

1. Scroll down the **Radio Configuration** pane until the **Diagnostic Command** section is visible.
2. Click the  refresh button in the **Association Indication** row to read the current association status. The Association Indication value provides information about whether the radio is currently associated with a network or an error value. The value zero (0) indicates that the radio has successfully associated with the network started by XBee Gateway. It may take several seconds for association to occur. Refresh multiple times "if necessary" to get ongoing status. You can find information on error values in the Module Manual for your radio module.

Read XBee configuration

You must install XCTU on your computer. If you do not have XCTU installed, go to www.digi.com/xctu to download and install XCTU.

To read the configured parameters of your XBee radio:

1. Open XCTU.
2. In XCTU, click the settings  icon to ensure the XCTU is in Configuration mode.
3. In the **Radio Modules** pane, click the entry for your radio. A dialog box displays the progress as the configuration is read from the radio.

Get the PAN ID and other network parameters for the Zigbee network

Use the XBee Zigbee Cloud Kit web application to retrieve the PAN ID of the Zigbee network that you want to join.

Zigbee networks are called personal area networks (PANs). Each network is defined with a unique PAN identifier (PAN ID), which is common among all devices of the same network. Zigbee devices are either preconfigured with a PAN ID to join, or they can discover nearby networks and select a PAN ID to join.

Zigbee supports both a 64-bit and a 16-bit PAN ID. Both PAN IDs are used to uniquely identify a network. Devices on the same Zigbee network must share the same 64-bit and 16-bit PAN IDs. If multiple Zigbee networks are operating within range of each other, each should have unique PAN IDs.

For information about retrieving the PAN ID, see these sections in the [XBee/XBee-PRO® S2C Zigbee® RF Modules User Guide](#):

- [PAN ID](#)
- [Discover Zigbee networks](#)

Configure the PAN ID and additional network parameters

Note You will need the PAN ID of the network you want to join before you start this task. See [Get the PAN ID and other network parameters for the Zigbee network](#).

To set the PAN ID parameter for the network you want to join:

1. Type your PAN ID. Replace the value currently displayed in the PAN ID field of the **Networking** section of the **Radio Configuration** pane with your PAN ID.
2. Click the write  icon in the PAN ID row to send your changes to the radio. The radio leaves its current network and searches for the network you have just configured.
3. If XBee Zigbee uses XBee security parameters, set the XBee security parameters (**EE**, **EO**, **NK**, **KY**) as needed. The security parameters are as follows:
 - **EE**: Enable or disable security in the network.
 - **EO**: Set the security policy for the network.
 - **NK**: Set the network security key for the network. If set to 0 (default), the device will use a random network security key.
 - **KY**: Set the trust center link key for the network. If set to 0 (default), the device will use a random network security key.

For more information on these parameters, see the [XBee/XBee-PRO® S2C Zigbee® RF Modules User Guide](#).

Configure Zigbee nodes with custom PAN ID

XBee Zigbee Cloud Kit includes an XBee Zigbee module configured as router node. If you want your Zigbee routers or end devices to connect to a Zigbee network with a specific PAN ID, you must

configure the Zigbee routers to use the specific PAN ID for the Zigbee network.

You must install XCTU on your computer. If you do not have XCTU installed, go to www.digi.com/xctu to download and install XCTU.

To configure other Zigbee nodes with a custom PAN ID:

1. Attach the XBee Zigbee node to the XBee development board included in the XBee Zigbee Cloud Kit, and connect it to your computer using a USB cable.
2. Open XCTU and add the XBee node that is connected to your computer to the list of radio modules.

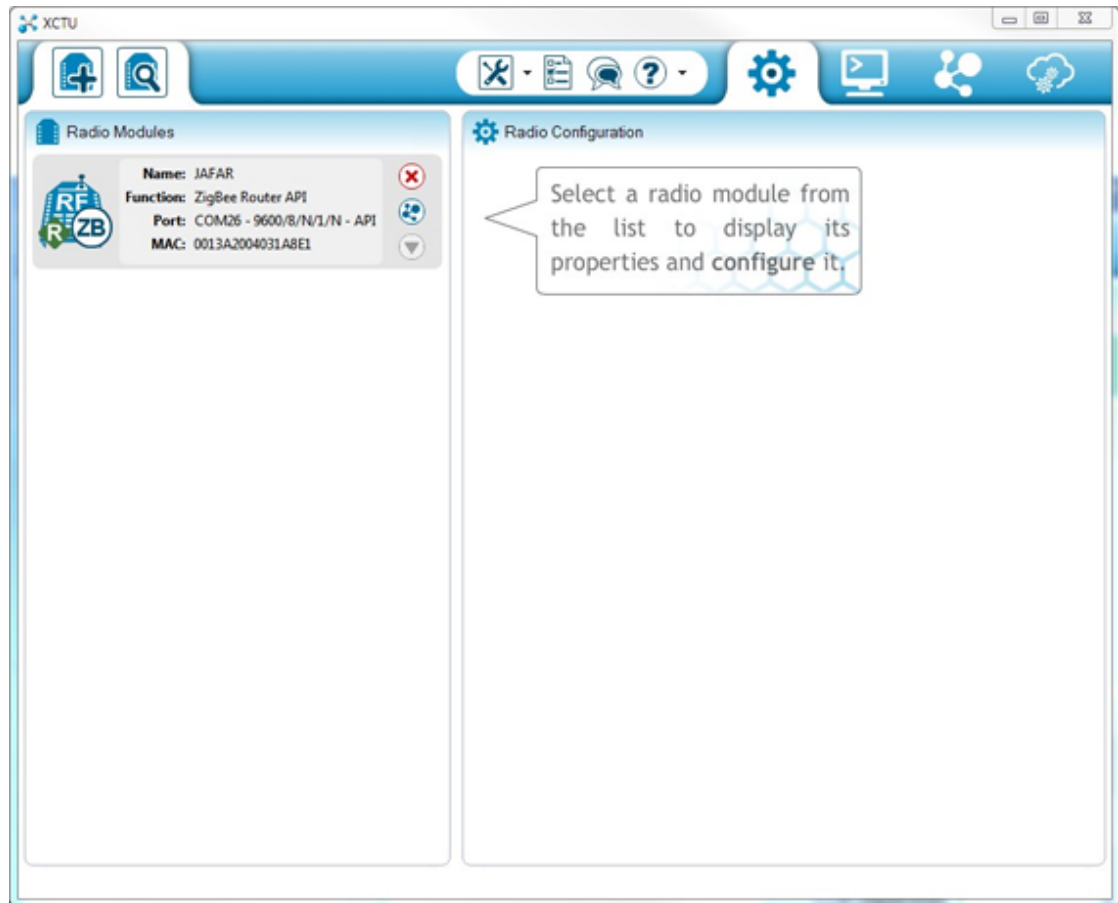

3. Select the node and wait for the application to read all its settings.

- Under the **Networking** category, replace the current PAN ID with your custom PAN ID in the **ID PAN ID** field.

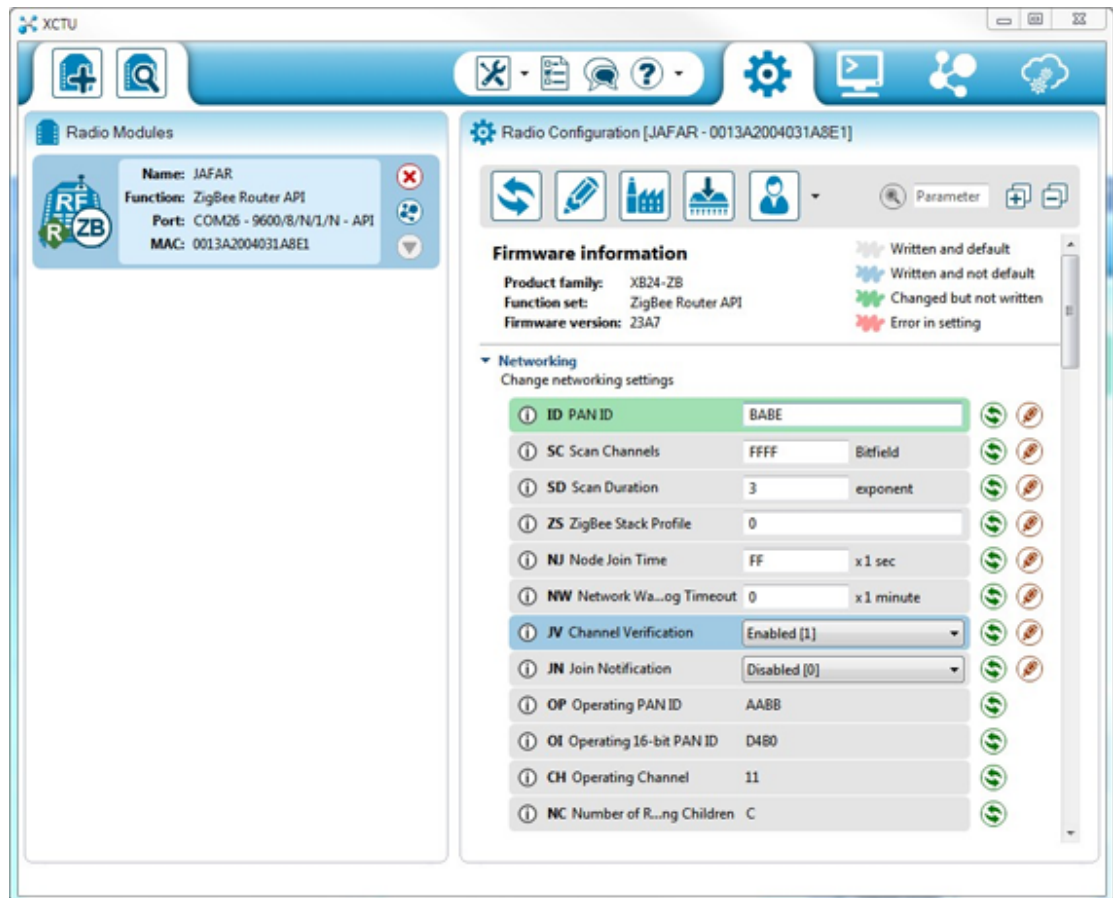

- Click the **Write radio settings** button to save the new PAN ID in the XBee module

As soon as you save the new PAN ID in the XBee RF module, the module tries to connect to the Zigbee network that has the PAN ID that you configured.

Create custom applications with the XBee Zigbee Cloud Kit

In addition to the following topics, you can find information related to the Digi devices and applications used throughout this kit on the [XBee Gateway product support page](#).

Create your own applications

You can build your own applications and connect anything to the internet.

Visit <https://github.com/digidotcom/XBeeZigbeeCloudKit> for the complete source code used to create the sample XBee Zigbee Cloud Kit web application. GitHub is a host site for various software development products, and has many features including discussion tools, access to repositories, and the ability to collaborate with other users.

XBee Zigbee Cloud Kit Examples

Digi provides a number of examples to help you make use of your kit and the XBee Zigbee Cloud Kit web application.

See the following resources:

- The [Examples & Guides](#) section of the Digi blog
- The Tech Tip [Connecting to the IoT with XBee Zigbee Cloud kit](#)

Note To complete the XBee Zigbee Cloud Kit examples, you must have a thorough understanding of your XBee Zigbee Cloud Kit and have completed the steps to set up your kit.

Connect your application to Remote Manager

Use one of the following methods to connect to Remote Manager:

- **Data Streams.** Visit the XBee Zigbee Cloud Kit application to learn about Data Streams. You can find the data stream section by navigating to **Data Services > Data Streams**. If you have already completed the steps in the [Get started](#) section, there are several data streams already available. The data streams are similar to the following example:

```
00000000-00000000-00409DFF-FF123456/xbee.digitalIn/  
[00:13:A2:00:11:22:33:44]!/DIO4
```

You can find all data streams for your XBee Gateway by searching for the device ID for your XBee Gateway; for example:

00000000-00000000-00409DFF-FF123456

Type the device ID for XBee Gateway in the data stream search box in the upper-right side of the data stream view.

- **Monitoring data streams with a TCP or HTTP monitor.** You can find more information about monitoring data streams by reading documentation about monitors. You also have access to various client libraries for the TCP Remote Manager monitors made available from the Digi International github account. The links to these libraries are located below:
 - [Remote Manager Push Monitor API for Python](#)
 - [Remote Manager Monitor API Library for Java](#)
- **Web APIs.** Log in to Remote Manager and use the API Explorer to see the available web service APIs.

Collaborate and share your story

Tell us what you have made. Share your story by submitting your own XBee project or other projects that you find interesting here at: www.digi.com/blog/category/xbee-projects/.

Troubleshoot your XBee Zigbee Cloud Kit

This section covers common issues and troubleshooting information for your XBee Zigbee Cloud Kit.

XBee Gateway fails to connect

XBee Gateway fails to connect to and communicate with Remote Manager.

Kit component: XBee Gateway

Potential cause

XBee Gateway is not configured properly.

Resolution

1. Open the XBee Gateway web interface and log in.
 - **User name:** The default user name is **python**. If that user name does not work, it may have been changed by your system administrator. Contact your system administrator for help.
 - **Password:** The unique, default password is printed on the device label. If the password is not on the device label, the default password is **dbps**. If these defaults do not work, the password may have been updated. Contact your system administrator for help.
2. Click **Configuration > Device Cloud Connectivity**.
3. Check the **Device Cloud Server Connection**. Make sure it is pointing to the proper Remote Manager server.

XBee Gateway fails to join the wireless network

XBee Gateway fails to join the wireless network.

Kit component: XBee Gateway

Potential cause

XBee Gateway is not configured properly.

Resolution

Make sure the wireless network you are trying to connect to is working. Rerun the Wireless wizard.

XBee module fails to join the network

The XBee module fails to join the network started by XBee Gateway.

Kit component: XBee module on the development board

Potential cause

XBee Gateway and XBee module have incompatible PAN ID and security settings.

Resolution

Check the **Extended PAN ID** and security settings and make sure they match those set for XBee Gateway. See [Join your XBee node to the Gateway network](#) for instructions.

Potential cause

The XBee module is not powered on.

Resolution

Apply power to the development board.

Potential cause

The XBee module is out of range.

Resolution

Move the XBee module closer to XBee Gateway. If the XBee module has an external antenna, make sure it is securely attached to the module.

Potential cause

The XBee module is sleeping.

Resolution

Press the **Commissioning** button on the development board once. The XBee module wakes and joins a network, if it is not currently joined to a network.

Potential cause

Your device may be listed under another Remote Manager account. By default, an XBee Zigbee device can only be associated with one Remote Manager account at a time. You need to remove the device from the Remote Manager account under which it is currently listed.

Resolution

1. Sign in to [Remote Manager](#).
2. Type your user name and password and click **Log in**.
3. Under the **Device Management** tab, right-click the device you want to delete and select **Remove Devices** from the list.

Development board changes are not reflected on the dashboard

Changes made from the XBee Zigbee development board are not reflected on the dashboard.

Kit component: XBee ZigBee Cloud Kit web application dashboard

Potential cause

Sampling rate and throttling of data on Remote Manager.

Resolution

1. Make sure your XBee Zigbee is properly connected, and wait at least 10 seconds for the application to update.
2. Refresh your browser and try again.

Potential cause

The connection between Remote Manager and the XBee Zigbee Cloud Kit web application may have been disconnected.

Resolution

Refresh your web browser to reload the dashboard page. If the problem persists, the dashboard may be experiencing issues setting up an HTTP push monitor in Remote Manager. In this case, an error appears in the dashboard, including the specific reason for the error. For example, there are too many push monitors set up for your Remote Manager account.

Dashboard functions not working as expected

Certain dashboard functions are not working properly.

Kit component: XBee ZigBee Cloud Kit web application dashboard

Potential cause

Web browser incompatibility.

Resolution

Try using a different web browser. The recommended web browsers for the XBee Zigbee Cloud Kit web application include Firefox and Google Chrome.

Potential cause

The development board may not be properly set for operation with an XBee Zigbee module.

Resolution

See [XBee Zigbee/Wi-Fi DIP switches on the XBee development board](#).

Data does not display the dashboard or Remote Manager

Data is not appearing in the XBee Zigbee Cloud Kit dashboard or Remote Manager.

Kit component: Data from the XBee nodes

Potential cause

The XBee Gateway application is not running, or is not loaded, on XBee Gateway.

Resolution

1. Check the Python Auto Start Settings (**Configuration > Python**). The **xbgw_main.py** application should have **Autostart** enabled. If not, enable **Autostart** and click **Apply**.
2. If Autostart for **xbgw_main.py** application is enabled, check the log file, **python.log**, on XBee Gateway for any errors related to the application.

Resolution

Use the File Management function in the XBee Gateway web interface or Remote Manager to determine whether the following files are loaded on XBee Gateway:

- **xbgw_main.py**
- **build.py**
- **xbgw.zip**
- **xbgw_settings.json**

If these files are not loaded, use the file management function to load them.

For more information on File Management, see the [XBee Gateway User Guide](#).