

# SRBH-06H1A1

## Non-Isolated DC-DC Converter

The SRBH-06H1A1 is part of the low-cost non-isolated DC-DC power converter series providing up to 6 A output current.

The output is closely regulated and the efficiency of 3.3 VDC output is typically 89% at full load.

Typical features include remote on/off, input under-voltage lockout, over current protection and short circuit protection.



### Key Features & Benefits

- 8 - 36 VDC Input
- 3.3 - 5 VDC @ 6 A Output
- Non-Isolated Output
- High Efficiency
- High Power Density
- Excellent Thermal Performance
- OCP/SCP
- Remote On/Off
- Input Under-Voltage Lockout
- Low Cost
- Class II, Category 2, Non-Isolated DC/DC Converter (refer to IPC-9592B)



### Applications

- Distributed Power Architectures
- Data Networking Equipment
- Telecommunications Applications

## 1. MODEL SELECTION

MODEL NUMBER	OUTPUT VOLTAGE	INPUT VOLTAGE	MAX. OUTPUT CURRENT	MAX. OUTPUT POWER	TYPICAL EFFICIENCY
SRBH-06H1A1G	3.3 - 5 V	8 - 36 V	6 A	30 W	89% (Vo = 3.3 V, Io = 6 A)
SRBH-06H1A1R					

### PART NUMBER EXPLANATION

S	R	BH	-	06	H	1A	1	x
Mounting Type	RoHS Status	Series Name		Output Current	Input Range	Output Voltage	Active Logic	Package Type
SMD	RoHS	Arrow Head		6 A	8 - 36 V	3.3 - 5.0 V	Active High	R - Tape & Reel Package G - Tray Package

## 2. ABSOLUTE MAXIMUM RATINGS

PARAMETER	DESCRIPTION	MIN	TYP	MAX	UNITS
Continuous Non-operating Input Voltage		-0.3	-	38	V
Remote On/Off		-0.3	-	12	V
Ambient Temperature		-40	-	85	°C
Storage Temperature		-40	-	125	°C
Altitude		-	-	2000	m

**NOTE:** Ratings used beyond the maximum ratings may cause a reliability degradation of the converter or may permanently damage the device.

## 3. INPUT SPECIFICATIONS

All specifications are typical at 25°C unless otherwise stated.

PARAMETER	DESCRIPTION	MIN	TYP	MAX	UNITS
Operating Input Voltage		8	-	36	V
Input Current (full load)	Vin = 12 V, Vo = 3.3 V, Io = 6 A	-	1.9	-	A
Input Current (no load)		-	30	-	mA
Remote Off Input Current		-	1.7	-	mA
Input Reflected Ripple Current (rms)	1 μH, 2*100 μF/50 V electrolytic capacitors,	-	50	100	mA
Input Reflected Ripple Current (pk-pk)	3*4.7 μF/50 V ceramic capacitor at the input.	-	70	150	mA
I <sup>2</sup> t Inrush Current Transient		-	-	1	A <sup>2</sup> s
Turn on Voltage Threshold		-	7	7.5	V
Turn off Voltage Threshold	Input under voltage lockout (UVLO).	3.5	4	-	V

**CAUTION:** All specifications are typical at nominal input, full load at 25°C unless noted.

## 4. OUTPUT SPECIFICATIONS

All specifications are typical at nominal input, full load at 25°C unless otherwise stated.

PARAMETER	DESCRIPTION	MIN	TYP	MAX	UNITS
Output Voltage Set Point	V <sub>in</sub> = 12 V, I <sub>o</sub> = 50% full load	3.234	3.300	3.366	V
Load Regulation		-	±10	±20	mV
Line Regulation		-	±10	±20	mV
Regulation Over Temperature	-40 °C to 85 °C	-	30	50	mV
Ripple and Noise (pk-pk)	V <sub>out</sub> = 3.3 V	-	60	100	mV
Ripple and Noise (rms)		-	25	50	mV
Output Current Range		0	-	6	A
Output DC Current Limit	Hiccup mode	7	10	13	A
Turn on Time (from V <sub>in</sub> )		-	6	10	ms
Turn on Time (from Enable)		-	1	-	ms
Output Capacitance		220	-	1200	µF
<b>Transient Response</b>					
ΔV 50%~100% of Max Load		-	100	200	mV
Settling Time	di/dt = 0.5 A/µs; V <sub>in</sub> = 12 V; V <sub>out</sub> = 3.3 V; with a 220 µF Oscan capacitor at the output	-	300	500	µs
ΔV 100%~50% of Max Load		-	100	200	mV
Settling Time		-	300	500	µs

## 5. GENERAL SPECIFICATION

PARAMETER	DESCRIPTION	MIN	TYP	MAX	UNITS
Efficiency	V <sub>in</sub> = 12 V, V <sub>o</sub> = 3.3 V, full load	87	89	-	%
Switching Frequency		-	300	-	kHz
Output Trim Range		3.3	-	5	V
Weight		-	4.3	-	g
MTBF		-	426,574,0	-	hours
Dimensions (L × W × H)		0.885 x 0.512 x 0.320			inch
		22.48 x 13.00 x 8.13			mm

## 6. CONTROL/SUPERVISORY SPECIFICATIONS

PARAMETER	DESCRIPTION	MIN	TYP	MAX	UNITS
<b>Enable</b>					
Signal Low (Unit Off)	ENABLE pin open, unit on	-0.3	-	1	V
Signal High (Unit On)		2.8	-	12	V
Sourcing current		-	-	10	µA

7. EFFICIENCY DATA

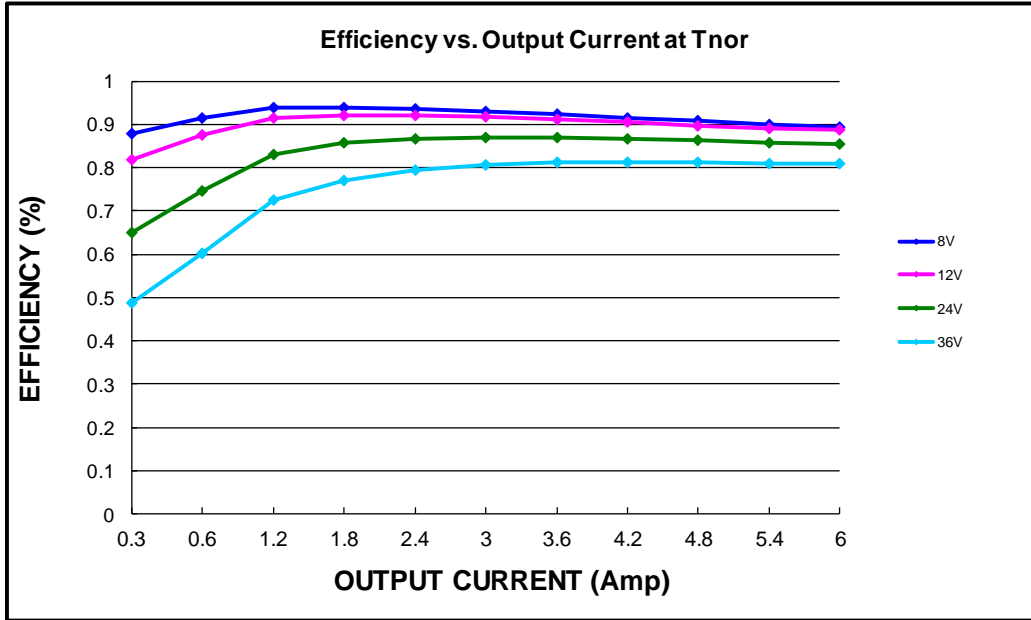

Figure 1. Efficiency data

8. THERMAL DERATING CURVE

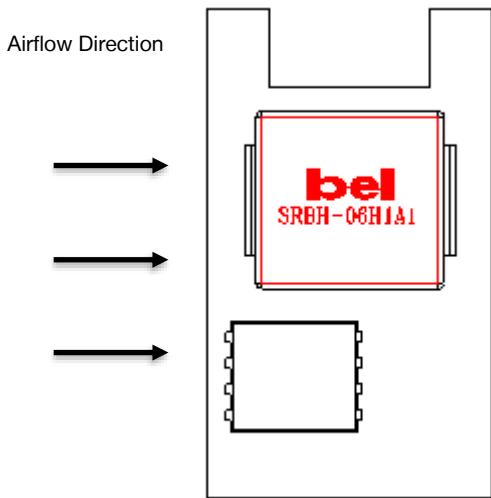

Figure 2. Airflow direction

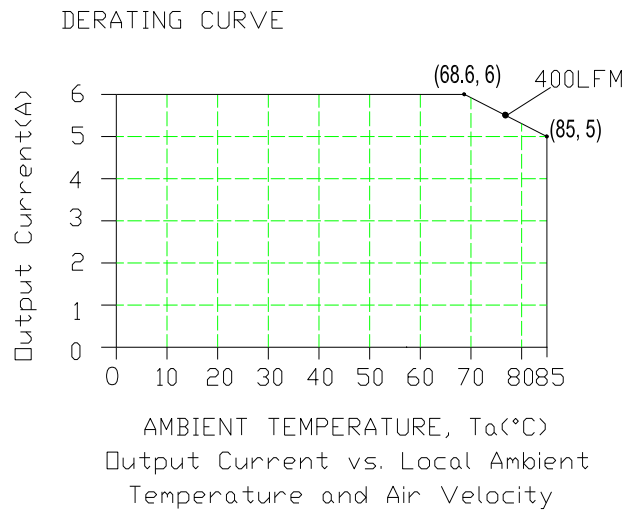

Figure 3. Thermal derating curve @  $V_{in} = 12V$ ,  $V_o = 3.3V$

9. RIPPLE AND NOISE WAVEFORM

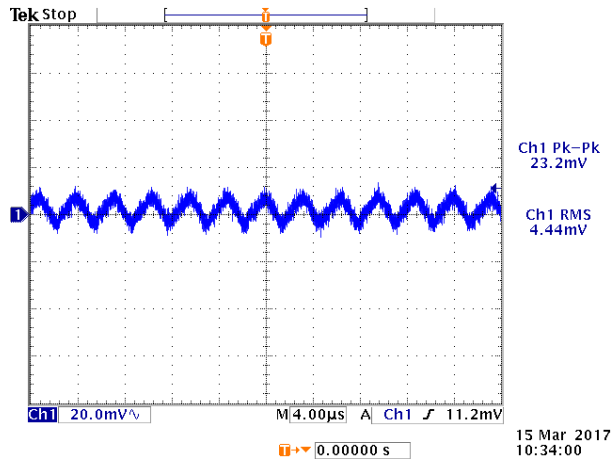

Figure 4. Ripple and noise at no load,  $V_{in} = 12 V$

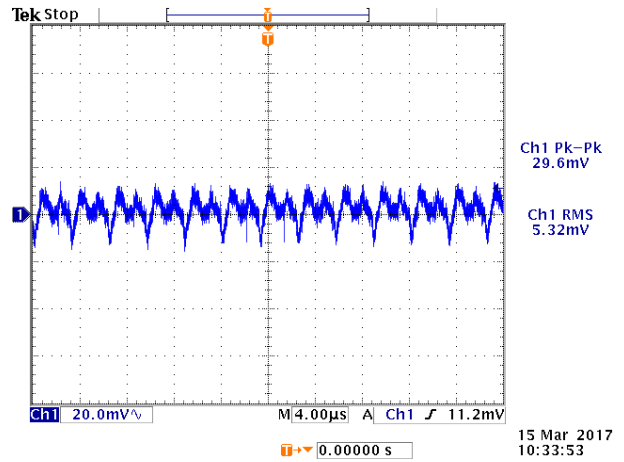

Figure 5. Ripple and noise at full load,  $V_{in} = 12 V$

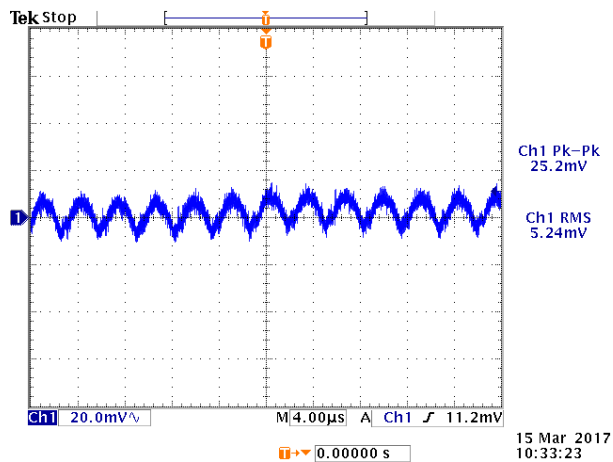

Figure 6. Ripple and noise at no load,  $V_{in} = 24 V$

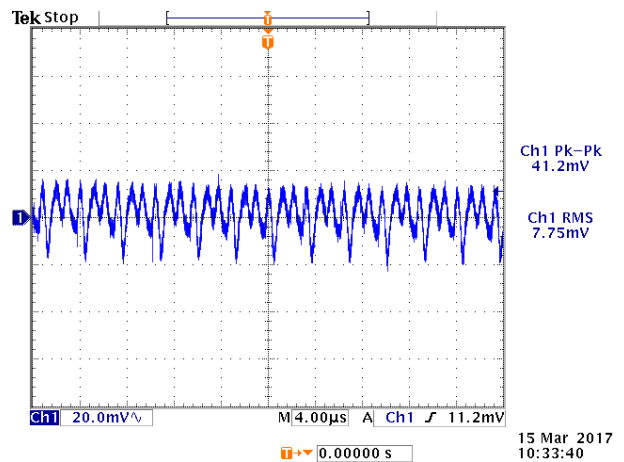

Figure 7. Ripple and noise at full load,  $V_{in} = 24 V$

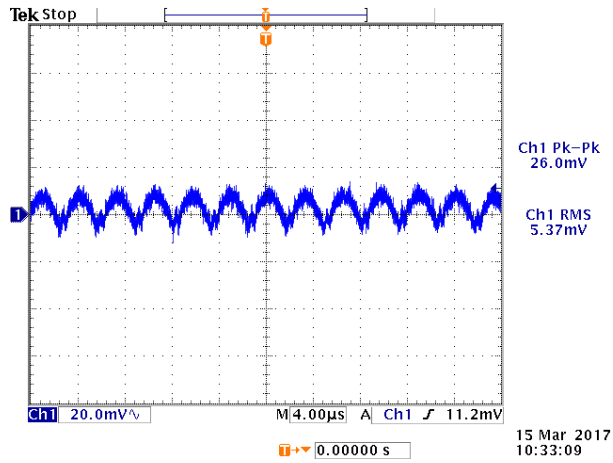

Figure 8. Ripple and noise at no load,  $V_{in} = 36 V$

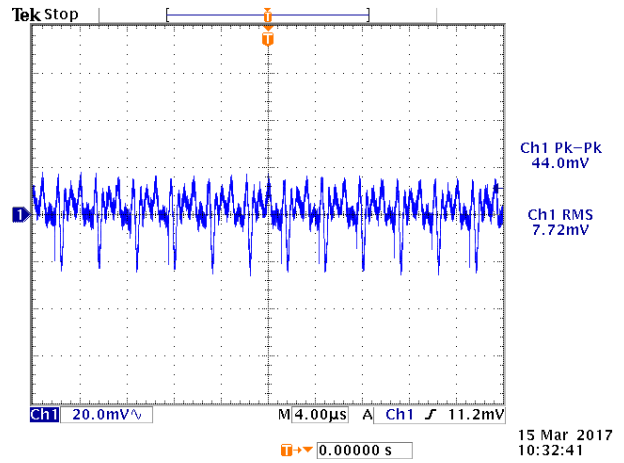

Figure 9. Ripple and noise at full load,  $V_{in} = 36 V$

**Note:** Ripple and Noise at 3.3 VDC output, with a 220 µF oscan capacitor cap at the output,  $T_a = 25^{\circ}C$

10. STARTUP & SHUTDOWN

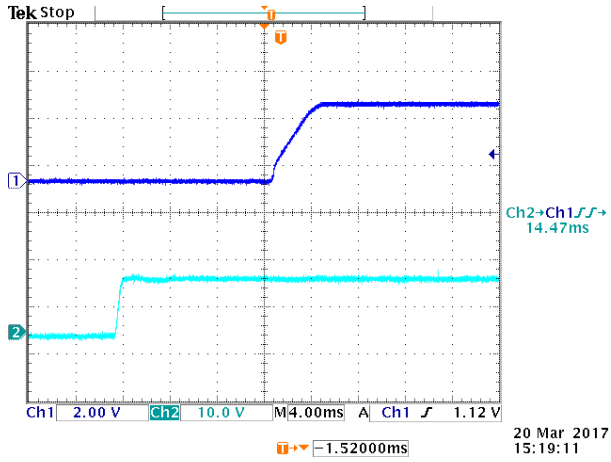

Figure 10. Startup

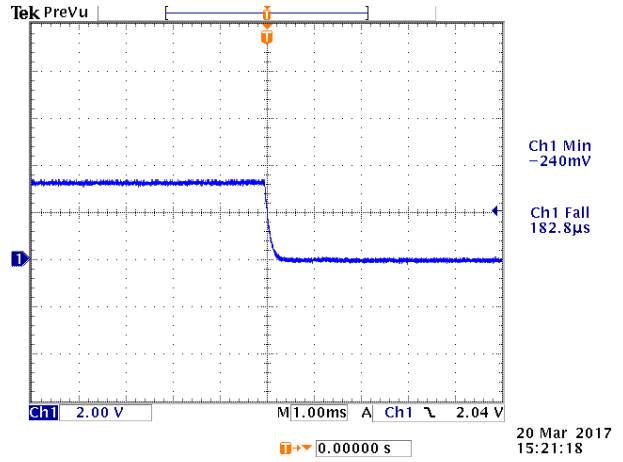

Figure 11. Shutdown

Test Condition:  $V_{in} = 12\text{ V}$ ,  $I_{out} = 6\text{ A}$ , with a  $220\ \mu\text{F}$  oscan capacitor at the output.

11. TRANSIENT RESPONSE WAVEFORMS

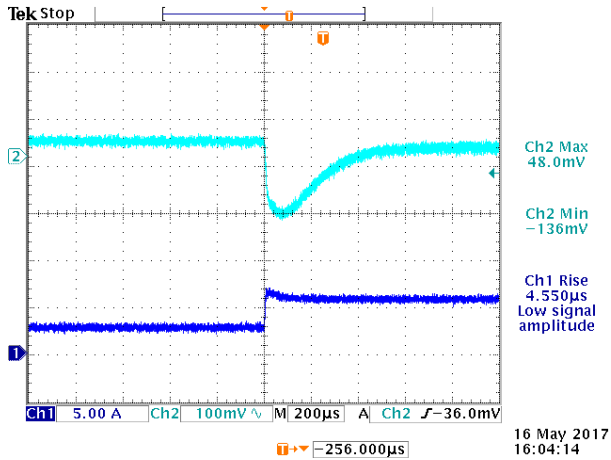

Figure 12. 50% to 100% load transient at 12 Vdc input, 5 Vdc output and  $T_a = 25^\circ\text{C}$

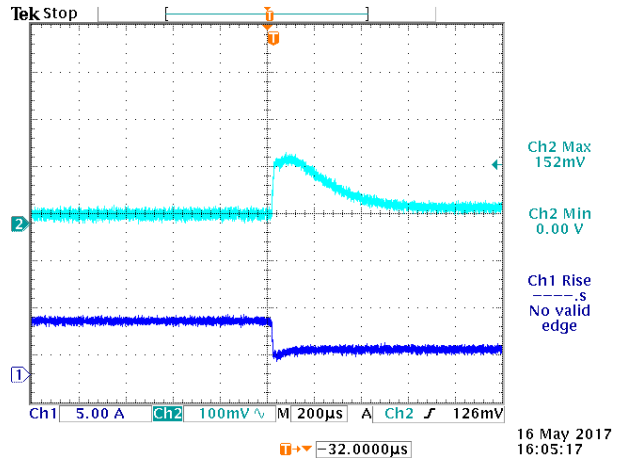

Figure 13. 100% to 50% load transient at 12 Vdc input, 5 Vdc output and  $T_a = 25^\circ\text{C}$

Test Condition:  $di/dt = 0.5\text{ A}/\mu\text{s}$ ,  $V_{in} = 12\text{ V}$ , with a  $220\ \mu\text{F}$  oscan capacitor at the output.

## 12. INPUT UNDER-VOLTAGE LOCKOUT

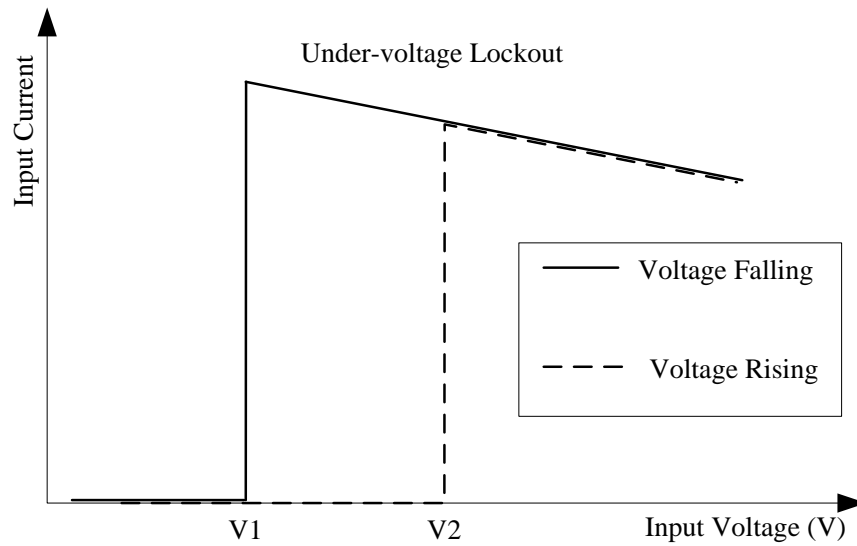

Figure 14. Input under-voltage lockout

$$V1 = 4 V$$

$$V2 = 7 V$$

## 13. OUTPUT VOLTAGE TRIM

Equations for calculating the trim resistor (in k $\Omega$ ) given the desired adjusted voltage ( $V_{adj}$ ) and the nominal output voltage of the converter ( $V_{nom} = 3.3 V$ ) are shown below. The Trim Down resistor should be connected between the Trim pin and  $V_{out}$ . The Trim Up resistor should be connected between the Trim pin and Ground. Only one of the resistors should be used for any given application.

$$R_{trimdown} = \frac{151.6}{V_{nom} - V_{adj}} - 70.2$$

$$R_{trimup} = \frac{33.7}{V_{adj} - V_{nom}} - 14$$



## 14. SOLDERING INFORMATION

The SRBH-06H1A1 modules are designed to be compatible with reflow soldering process. The suggested Pb-free solder paste is Sn/Ag/Cu(SAC). The recommended reflow profile using Sn/Ag/Cu solder is shown in the following. Recommended reflow peak temperature is 245°C while the part can withstand peak temperature of 260°C maximum for 10seconds. This profile should be used only as a guideline. Many other factors influence the success of SMT reflow soldering. Since your production environment may differ, please thoroughly review these guidelines with your process engineers.

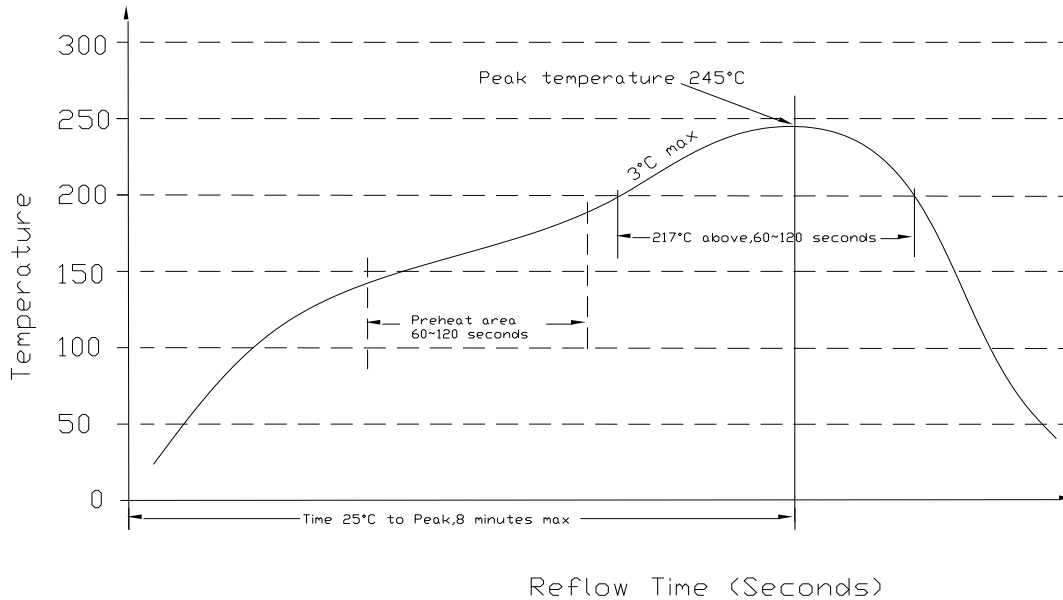

Figure 15. Soldering information

## 15. MSL RATING

The SRBH-06H1A1 modules have a MSL rating of 3.

## 16. STORAGE AND HANDLING

The SRBH-06H1A1 modules are designed to be compatible with J-STD-033 Rev:A (Handling, Packing, Shipping and Use of Moisture /Reflow Sensitive surface Mount devices). Moisture barrier bags (MBB) with desiccant are applied. The recommended storage environment and handling procedure is detailed in J-STD-033.

## 17. PRE-BAKING

This component has been designed, handled, and packaged ready for Pb-free reflow soldering. If the assembly shop follows J-STD-033 guidelines, no pre-bake of this component is required before being reflowed to a PCB. Our packaging tray can only withstand temperature of 70°C max.

18. MECHANICAL DIMENSIONS

OUTLINE

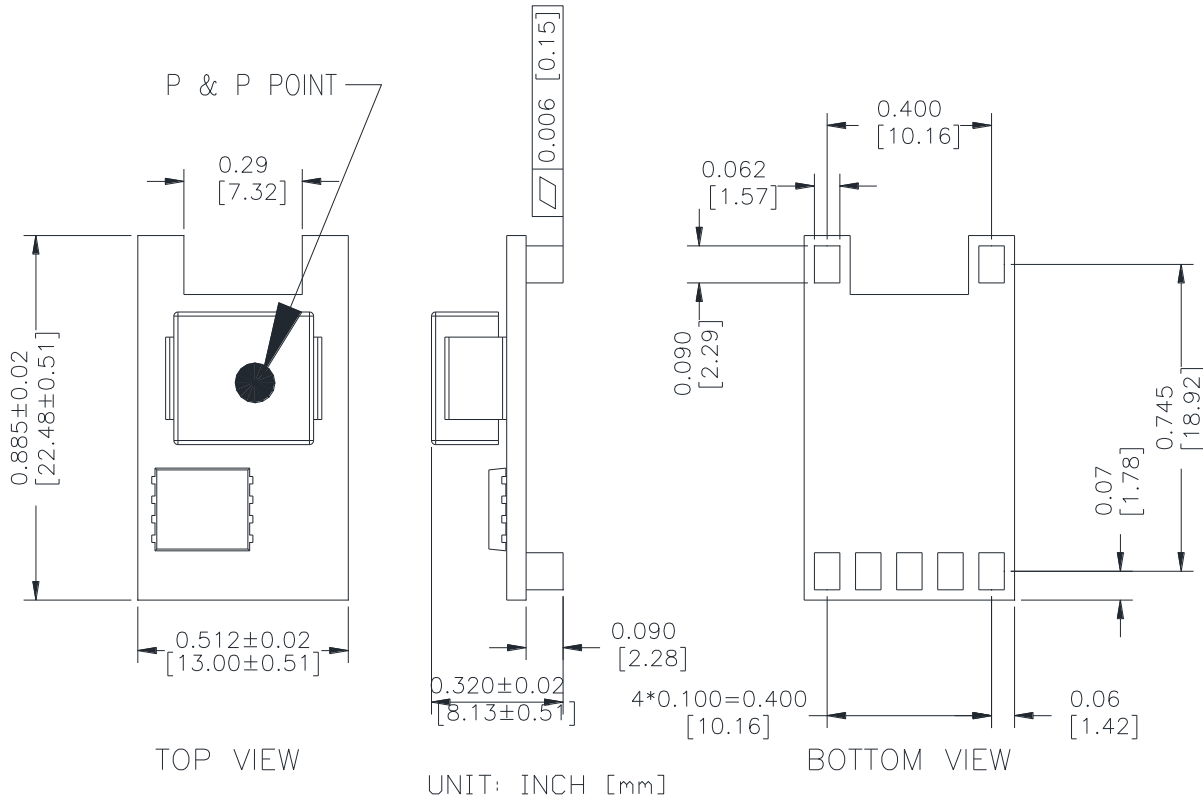

Figure 16. Outline

NOTES:

- 1) All Pins: Material - Copper Alloy;  
Finish - Gold plated
- 2) Un-dimensioned components are shown for visual reference only.
- 3) All dimensions in inch [mm]; Tolerances: x.xx +/-0.02 inch [0.51 mm]. x.xxx +/-0.010 inch [0.25 mm].

## PIN DEFINITIONS

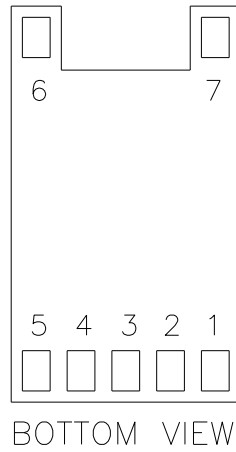

Figure 17. Pins

PIN	FUNCTION	PIN	FUNCTION
1	Remote On/Off	5	Trim
2	Vin	6	N/A
3	GND	7	N/A
4	Vout		

## RECOMMENDED PAD LAYOUT

### RECOMMENDED PCB PAD LAYOUT

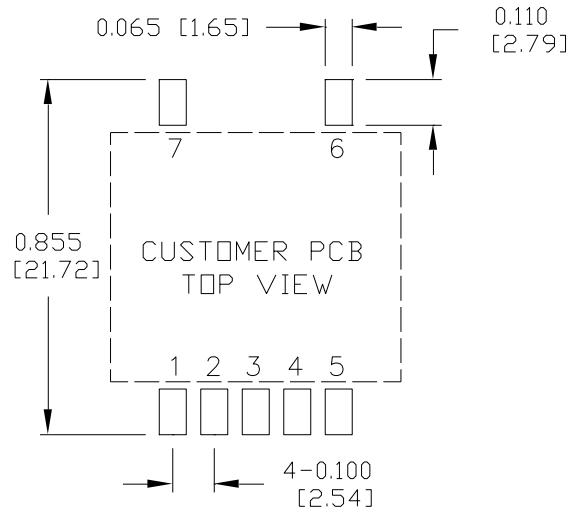

Figure 18. Recommended pad layout

**19. PACKAGING INFORMATION**

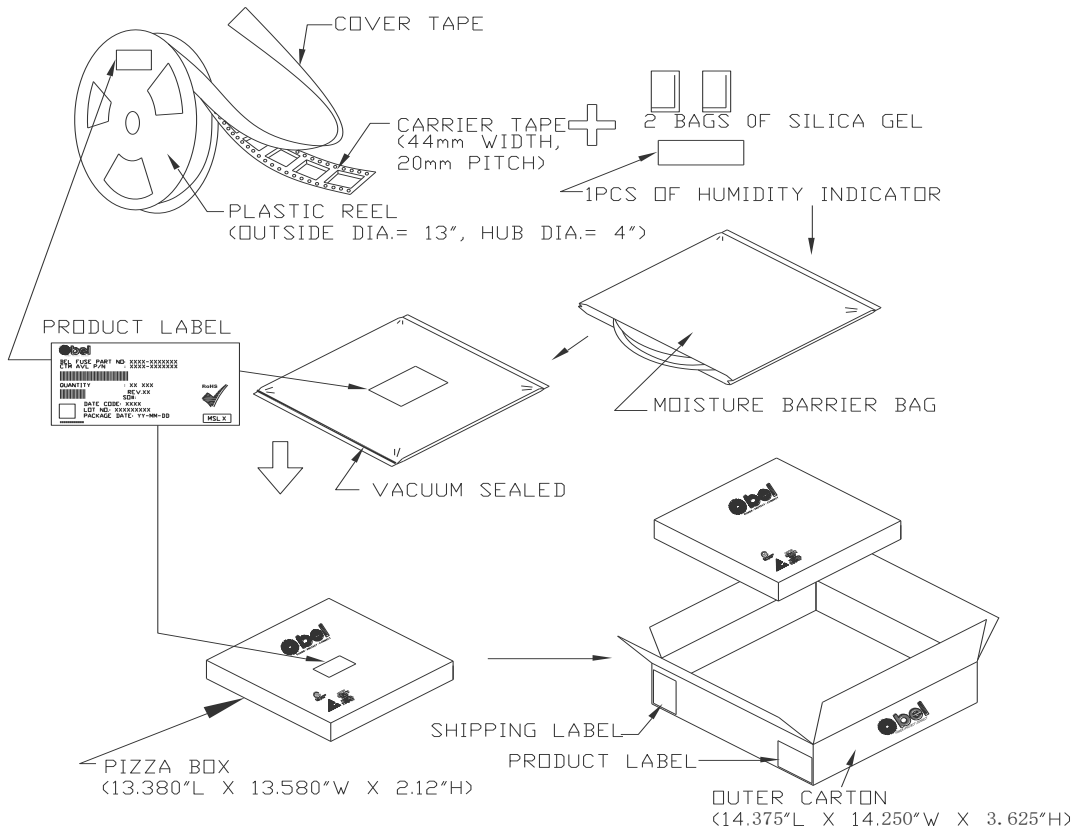
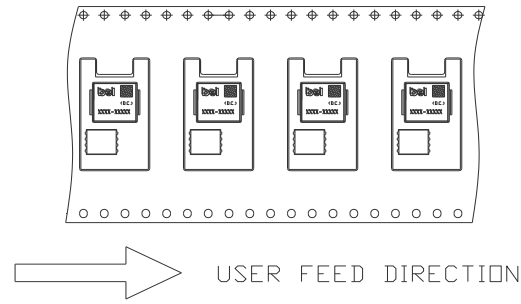

Figure 19. Packaging information-1



ORIENTATION OF COMPONENT INSIDE POCKET

TAPE WIDTH	44mm
POCKET PITCH	20mm
QUANTITY OF COMPONENTS PER REEL	320
PLASTIC REEL OUTER DIAMETER	13 INCHES
PLASTIC REEL HUB DIAMETER	4 INCHES
COMPLY WITH EIA 481-2-A	

*Figure 20. Packaging information-2*

## 20. REVISION HISTORY

DATE	REVISION	CHANGES DETAIL	APPROVAL
2017-03-23	AA	First release.	S.Wang
2017-05-16	AB	Change MTBF UVLO, Add packaging information.	S.Wang
2017-08-29	AC	Update Line and load Regulation, Output Current Limit, Transient response, Input Reflected Ripple Current.	S.Wang
2018-04-26	AD	Update PRE-BAKING.	S.Wang
2018-05-24	AE	Add G – Tray package, Update MD.	S.Wang
2021-01-11	AF	Update outline notes to gold plated.	XF.Jiang
2021-07-05	AG	Add object ID. Add thermal test airflow direction.	XF.Jiang

For more information on these products consult: [tech.support@psbel.com](mailto:tech.support@psbel.com)

**NUCLEAR AND MEDICAL APPLICATIONS** - Products are not designed or intended for use as critical components in life support systems, equipment used in hazardous environments, or nuclear control systems.

**TECHNICAL REVISIONS** - The appearance of products, including safety agency certifications pictured on labels, may change depending on the date manufactured. Specifications are subject to change without notice.



[tech.support@psbel.com](mailto:tech.support@psbel.com)  
[belfuse.com/power-solutions](http://belfuse.com/power-solutions)