

Features

Power Module

- Wide input range (4 - 18V)
- Low profile 1.45mm
- Small footprint 3x3mm
- Adjustable output 0.8 to 5.2V
- Up to 120°C ambient temperature with derating
- Integrated solution



RPL-3.0

3.0 Amp
10 Pad LGA
Package

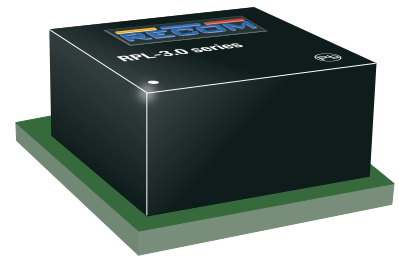

EN55032 compliant

Description

The RPL-3.0 is a buck converter with integrated inductor in a tiny 3mm x 3mm x 1.45mm thermally-enhanced LGA package. The input range is from 4.0 to 18VDC, allowing 5V and 12V supply rails to be used. The output voltage can be set with two resistors in the range from 0.8V up to 5.2V. The output current is up to 3A and is fully protected against continuous short-circuits, output overcurrent or over-temperature faults. Its high current and small size make the RPL-3.0 ideal for imaging systems, distributed power architectures, portable equipment in telecom as well as industrial applications.

Selection Guide

Part Number	Input Voltage Range [VDC]	Output Voltage [VDC]	Output Current max. [mA]	Efficiency ⁽¹⁾ typ. [%]
RPL-3.0	4.0-18.0	0.8-5.2	3000	89

Notes:

Note1: Efficiency tested at $V_{IN}= 12VDC$, full load and $V_{OUT}= 3.3VDC$

Model Numbering

RPL-3.0-

Output Current _____ Packaging ⁽²⁾

Notes:

Note2: add suffix "-R" for tape and reel packaging

add suffix "-CT" for cut tape packaging (refer to "**PACKAGING INFORMATION**")

Specifications

ABSOLUTE MAX RATINGS (exceeding these ratings may damage the device)				
Parameter	Symbol	Min.	Typ.	Max.
Absolute Maximum Voltage	V_{IN}	-0.3VDC		20VDC
	V_{OUT}	0VDC		6.5VDC
	V_{CTRL}	0VDC		18VDC
	V_{PG}	0VDC		5.5VDC
	others ⁽³⁾	-0.3VDC		4VDC
Maximum continuous power losses ⁽⁴⁾	@ $T_{AMB} = 25^{\circ}C$			2.08W
Junction Temperature	T_J			150°C
Lead Temperature				260°C

Notes:

Note3: For CTRL absolute max ratings, please refer to "**CTRL and SYNC Operating CONDITIONS**"

Note4: Exceeding maximum allowable power dissipation causes device to enter thermal shutdown which protects device from permanent damage. Refer to "**CHARACTERISTIC CURVES**"



www.recom-power.com/eval-ref-boards

Specifications

OPERATING CONDITIONS ($V_{IN}= 12VDC$, $T_J= -40^{\circ}C$ to $+125^{\circ}C$, unless otherwise noted, typical values are at $T_J= +25^{\circ}C$)

Parameter	Symbol	Condition	Min.	Typ.	Max.
Input Voltage Range	V_{IN}		4VDC		18VDC
UVLO threshold rising			3.2VDC	3.6VDC	3.9VDC
UVLO threshold falling				3.1VDC	
UVLO threshold hysteresis				500mV	
Output Voltage Range	V_{OUT}		0.8VDC		5.2VDC
Output Current Range	I_{OUT}		0A		3A
Standby current	I_{IN}	$V_{CTRL} = 0VDC$			15 μ A
Quiescent current	I_Q	$V_{FB} = 0.85VDC$, no switching		1.2mA	
Switching frequency	f_{SW}		1870kHz	2200kHz	2530kHz
Feedback voltage	V_{FB}		788mV	800mV	812mV
Output load regulation		0-100% load @ $3.3V_{OUT}$	-0.5%		+0.5%
V_{CC} regulator	V_{CC}			3.3VDC	
V_{CC} load regulation		$I_{CC} = 20mA$		3%	
Rise time		V_{OUT} from 10% to 90%		1.65ms	

Typical Application

$V_{IN}= 4-18VDC$; $V_{OUT}= 3.3VDC$, $I_{OUT}= 3A$

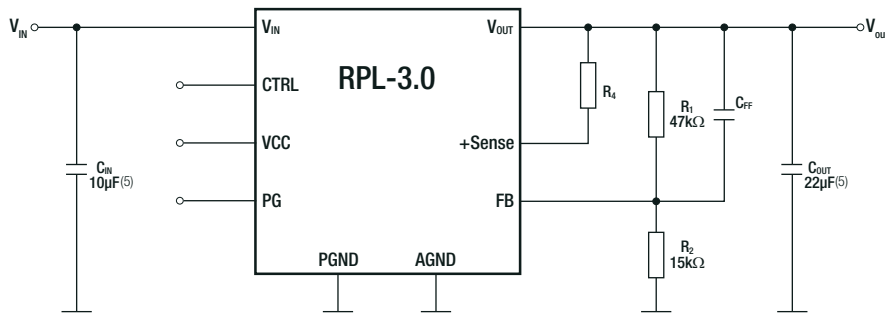

Notes:

Note5: A 10 μ F input capacitor (C_{IN}) is required to absorb the input switching current. A 22 μ F output capacitor (C_{OUT}) is mandatory. To get stable regulation use for R_1 and R_2 1% or 0.1% resistors, R_4 should be 1kOhm. RECOM recommends low ESR X5R or X7R ceramic caps.

Safe Operating Area

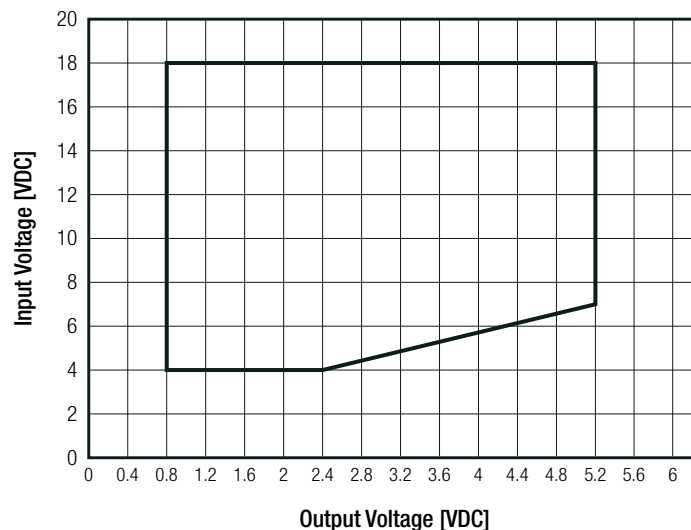

Specifications

CTRL OPERATING CONDITIONS ($V_{IN}= 12VDC$, $T_J= -40^{\circ}C$ to $+125^{\circ}C$, unless otherwise noted, typical values are at $T_J= +25^{\circ}C$)

Parameter	Symbol	Condition	Min.	Typ.	Max.
CTRL rising threshold	V_{CTRL_RISING}		1.1VDC	1.2VDC	1.3VDC
CTRL falling threshold	$V_{CTRL_FALLING}$		0.96VDC	1VDC	1.04VDC

POWER GOOD OPERATING CONDITIONS ($V_{IN}= 12VDC$, $T_J= -40^{\circ}C$ to $+125^{\circ}C$, unless otherwise noted, typical values are at $T_J= +25^{\circ}C$)

Parameter	Symbol	Condition	Min.	Typ.	Max.
OV rising threshold	V_{FB}	PG_{OVHI} fault	110%	115%	120%
OV falling threshold	V_{FB}	PG_{OVL0} good		110%	
UV rising threshold	V_{FB}	PG_{UVHI} good	85%	90%	95%
UV falling threshold	V_{FB}	PG_{UVLO} fault		80%	
Sink current capability	V_{PG}	$sink_{current} = 4mA$		0.4VDC	0.6VDC

PROTECTIONS

Parameter	Symbol	Condition	Min.	Typ.	Max.
Over current Limitation	L_{Limit1}	current monitor via internal MOSFET $R_{DS(on)}$	3A	3.3A	3.9A
OVP threshold	V_{OVP}	if V_{FB} is greater than V_{OVP} , for t_{OVP} , device will enter hiccup mode	110%	115%	120%
OVP hysteresis		disabled during soft start		5%	
Over voltage delay	t_{OVP}	if V_{FB} is greater than V_{OVP} , for t_{OVP} , device will enter hiccup mode		2 μs	
Output pin OVP	$V_{OVP\ FB > 115\%}$		5.7VDC	6VDC	6.3VDC
Absolute OVP hysteresis				50mV	

THERMAL OPERATING CONDITIONS ($V_{IN}= 12VDC$, $T_J= -40^{\circ}C$ to $+125^{\circ}C$, unless otherwise noted, typical values are at $T_J= +25^{\circ}C$)

Parameter	Symbol	Condition	Min.	Typ.	Max.
Operating Junction Temperature	T_J		-40 $^{\circ}C$		+125 $^{\circ}C$
Thermal Resistance ⁽⁶⁾	R_{thJA} R_{thJC}	junction to ambient junction to case		65K/W 30K/W	
Thermal shutdown		hysteresis		150 $^{\circ}C$ 20 $^{\circ}C$	

Notes:

Note6: Tested with RECOM evaluation module: [RPL-3.0-EVM-1](#)

OUTPUT VOLTAGE SETTING

The external resistor divider sets the output voltage. Choose the R1 resistance. R2 can be estimated with Equation:

$$R2 = \frac{R1}{\frac{V_{OUT}}{0.8VDC} - 1}$$

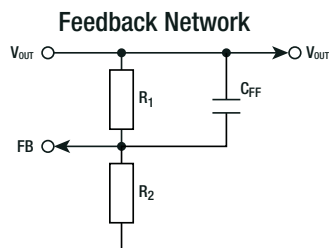

Where V_{OUT} is the output voltage. The output voltage feedback gain is determined by:

$$G_{FB} = \frac{R2}{R1 + R2}$$

To stabilize the system and optimize the load transient response, place a feed-forward capacitor (C_{FF}) in parallel with R1. Upper table shows the values of feedback resistors and feed-forward capacitors for common output voltages.

Table below lists recommended resistor values for common Vout:

V_{OUT} [V]	R1 [k Ω]	R2 [k Ω]	C_{FF} [pF]	C_{OUT} [μF]
1	47	187	22	22
1.2	47	93.1	22	22
1.5	47	53.6	22	22
1.8	47	37.4	22	22
2.5	47	22	39	22
3.3	47	15	39	22
5	47	8.87	39	22

Specifications

TYPICAL PERFORMANCE CHARACTERISTICS ($V_{OUT}= 1.8VDC$, $T_J= +25^{\circ}C$; tested with RECOM evaluation module: RPL-3.0-EVM-1)

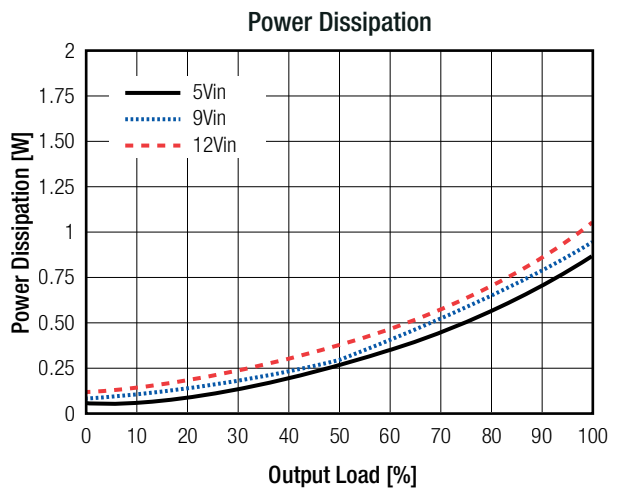
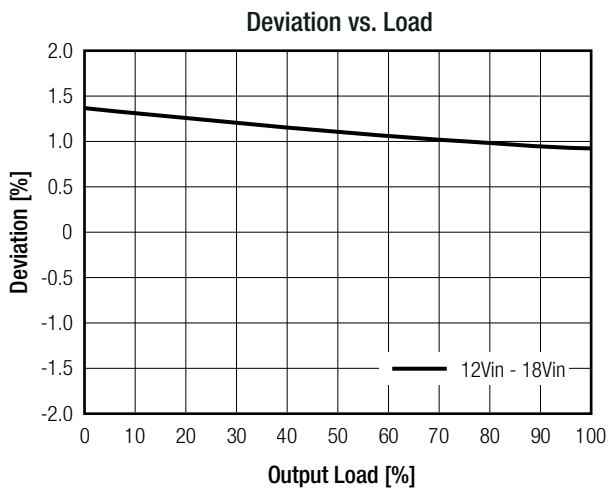
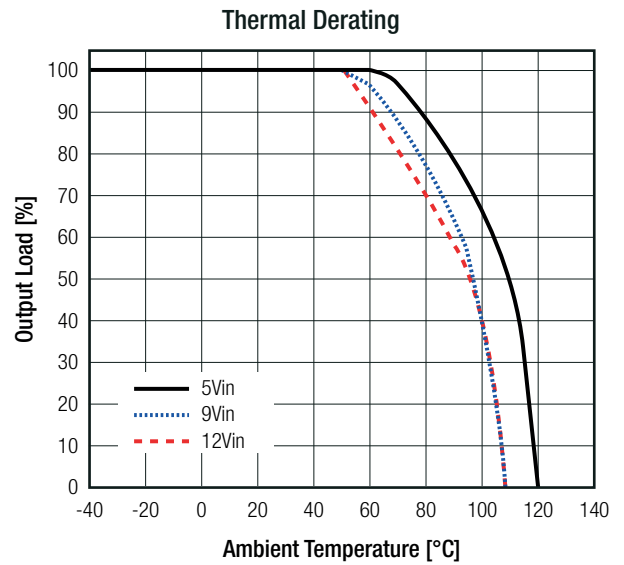
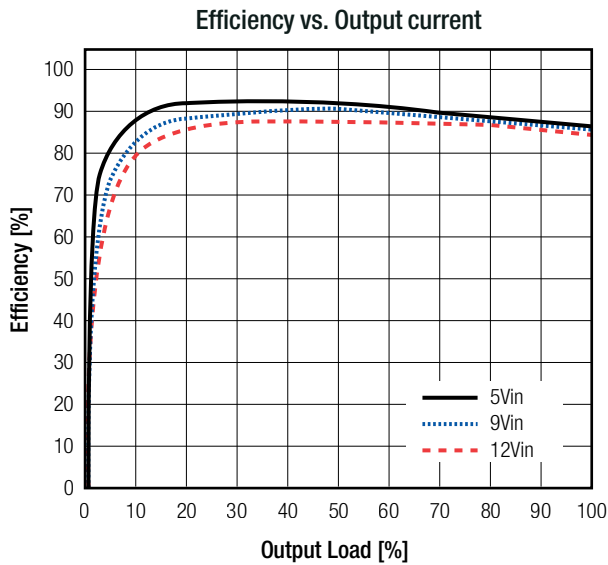

TYPICAL PERFORMANCE CHARACTERISTICS ($V_{OUT}= 3.3VDC$, $T_J= +25^{\circ}C$; tested with RECOM evaluation module: RPL-3.0-EVM-1)

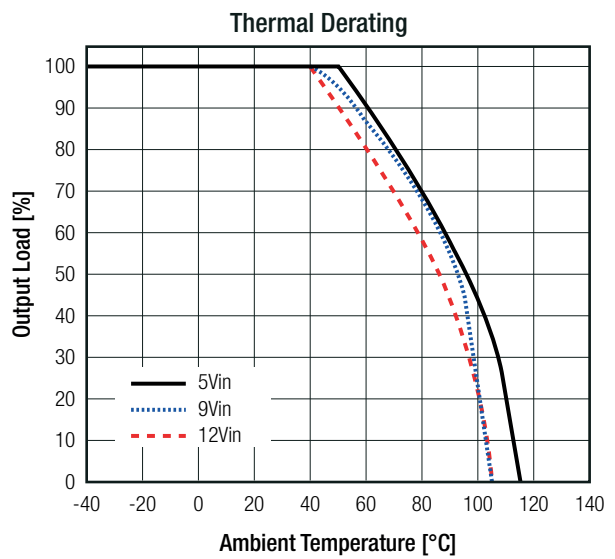
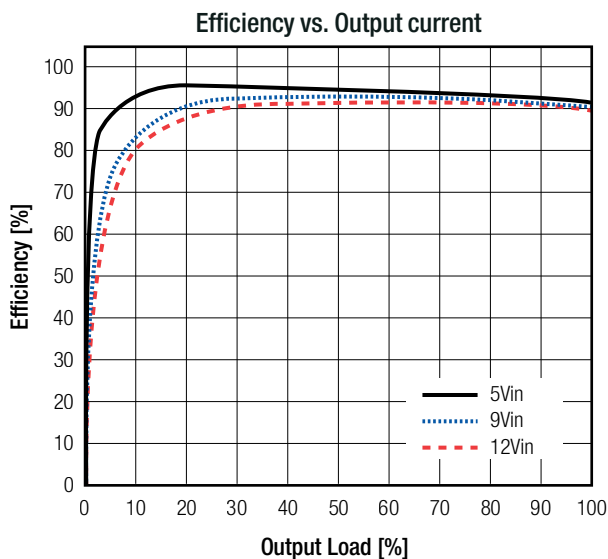

continued on next page

Specifications

TYPICAL PERFORMANCE CHARACTERISTICS ($V_{OUT} = 3.3VDC$, $T_J = +25^\circ C$; tested with RECOM evaluation module: RPL-3.0-EVM-1)

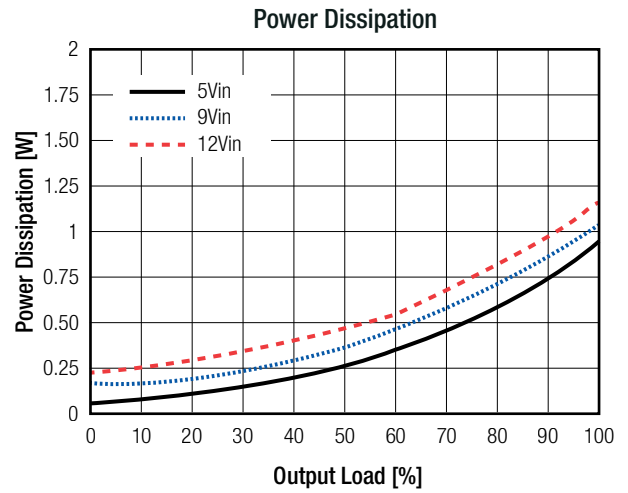
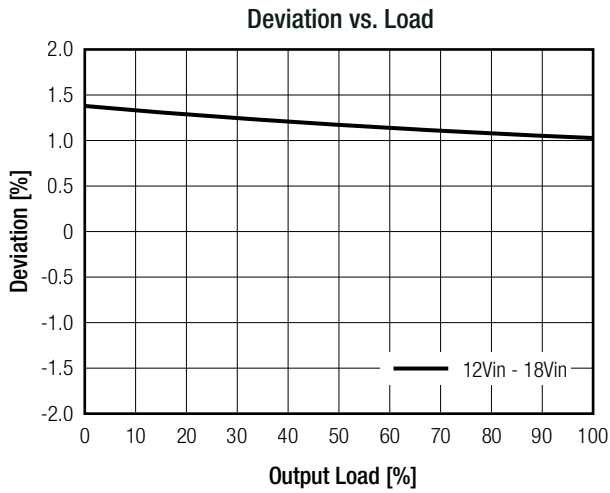

TYPICAL PERFORMANCE CHARACTERISTICS ($V_{OUT} = 5VDC$, $T_J = +25^\circ C$; tested with RECOM evaluation module: RPL-3.0-EVM-1)

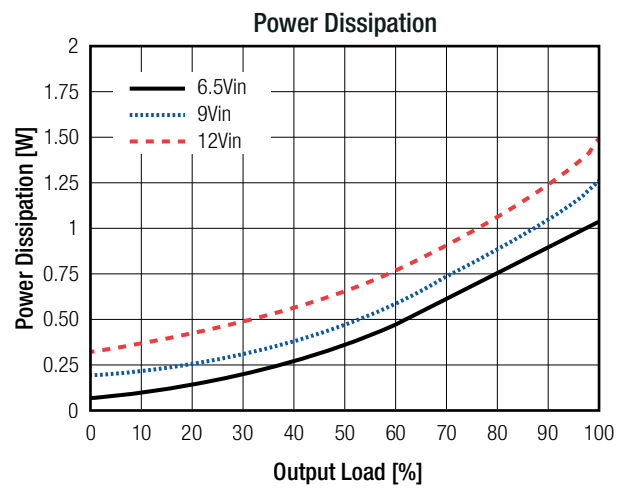
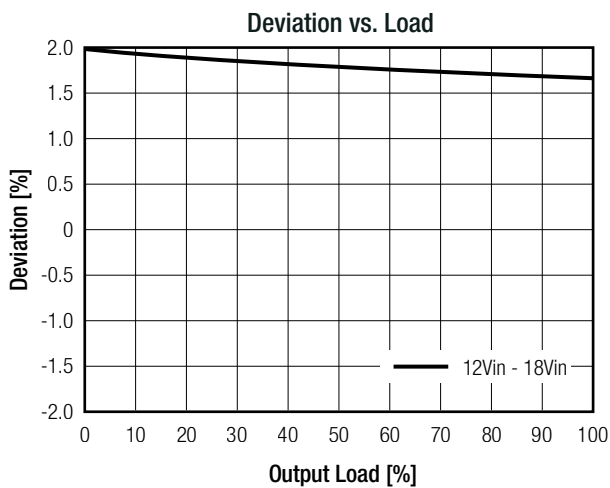
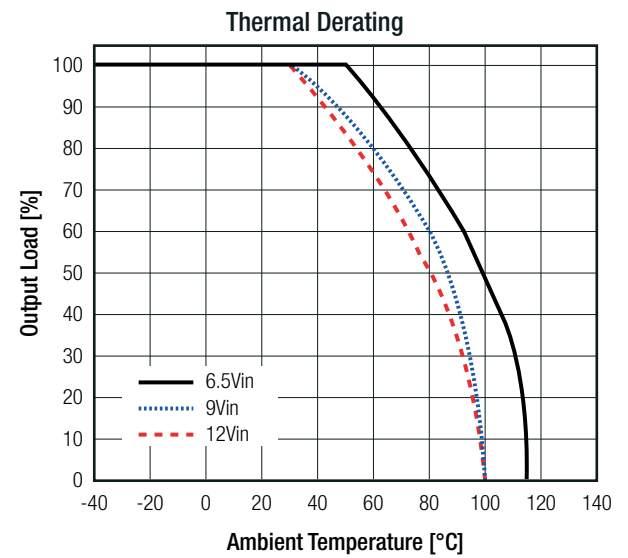
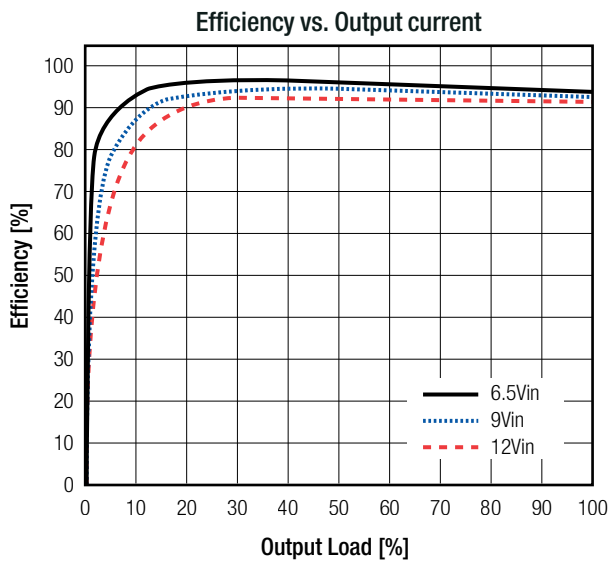

Specifications

SAFETY AND CERTIFICATIONS

Certificate Type (Safety)	Standard
RoHS2	RoHS 2011/65/EU + AM2015/863

DIMENSION AND PHYSICAL CHARACTERISTICS

Parameter	Type	Value
Material		plastic
Dimension (LxWxH)		3.00 x 3.00 x 1.45mm
Weight		0.1g typ.

Dimension Drawing (mm)

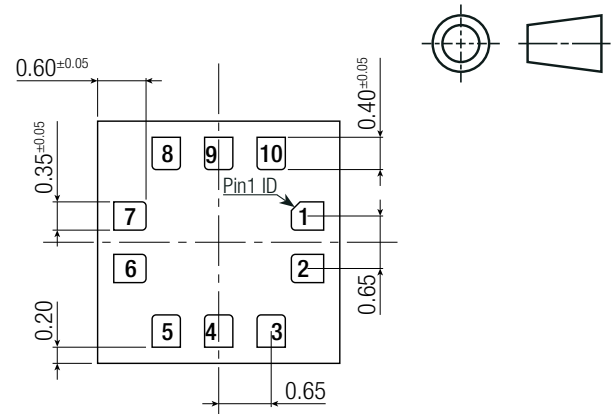
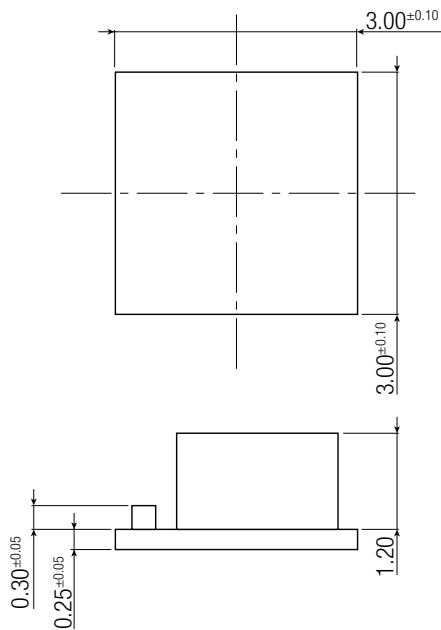

Recommended Footprint Details (Top View)

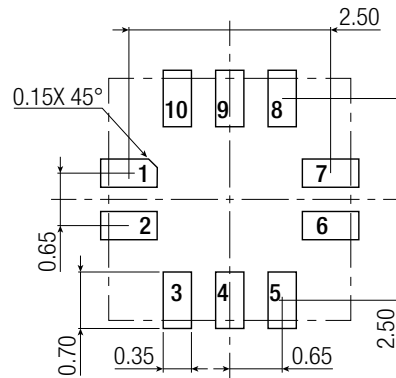

Pad Information

Pad #	Function	Description
1	CTRL	CTRL pin. Connect to V_{IN} when not used.
2	V_{IN}	Input voltage. Connect using wide PCB traces. Requires C_{in} to decouple input rail.
3, 4	PGND	System ground. Reference ground of the regulated output voltage. AGND is connected to PGND internally. Requires special consideration during PCB layout. Connect to PGND with copper traces and vias.
5	V_{OUT}	Output voltage. Connect external bypass capacitors between this pin and GND close to the pins.
6	+Sense	Output voltage sense pin
7	FB	Feedback input. Used to set the output voltage between 0.8V and 5.2V
8	AGND	Analog ground. (reference GND for FB pin) refer to "PCB Layout Suggestion"
9	VCC	Internal 3.3VDC LDO regulator output.
10	PG	Power good output.

Tolerances: x.x= ±0.1mm
x.xx= ±0.05mm

Specifications

SOLDERING

Wave or Reflow etc.

Profile Feature	PB-Free Assembly
Preheat	
minimum Temperature (TS_min)	155°C
maximum Temperature (TS_max)	245°C
Time (tS)	100s-300s
Liquidus	
Temperature (TL)	217°C
Time (tL)	30-60s
Peak Temperature (TP)	245°C
Time remaining around Peak Temperature	10s
max Ramp Down Rate (from Ts_max to TP)	5°C/s
max Ramp Up Rate	3°C/s
max time from 25°C to Peak Temperature (TP)	8min

- 1 Pb-Free assembly is recommended according to JEDEC J-STD020.
- 2 Ensure that the peak reflow temperature does not exceed 240°C ±5°C as per JEDEC J-STD020
- 3 The reflow time period during peak temperature of 240°C ±5°C should not exceed 30 seconds.
- 4 Reflow time above liquidus (217°C) should not exceed 150 seconds.
- 5 For solder paste use a standard SAC Alloy such as SAC 305, type 3 or higher.
- 6 Other soldering methods (e.g. vaporphase) are not verified and have to be validated at his own risk.

Solder Pofil

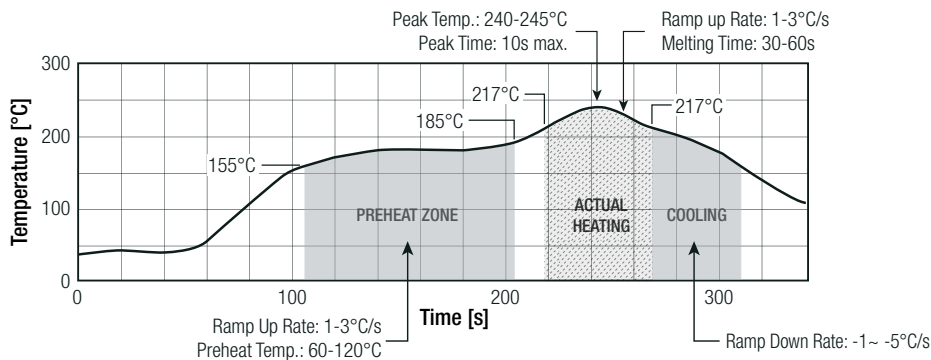

PCB LAYOUT SUGGESTION

Efficient PCB layout is critical for stable operation. For the best results, see Figure below and follow the guidelines below:

1. Keep the connection of the input ground and PGND as short and wide as possible.
2. Ensure that all feedback connections are short and direct.
3. Place the feedback resistors as close to the chip as possible.
4. Route sensitive analog areas such as FB away from SW.
5. Place enough vias around the chip to improve thermal performance.

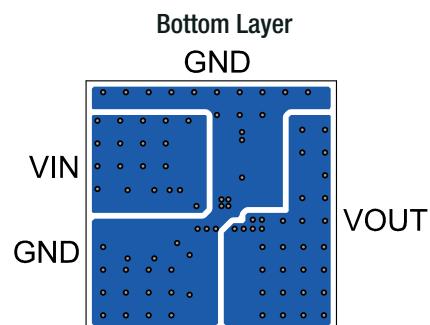
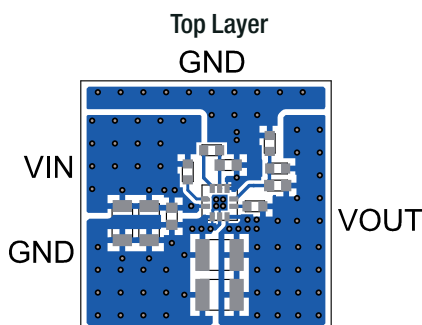

Specifications

BLOCK DIAGRAM

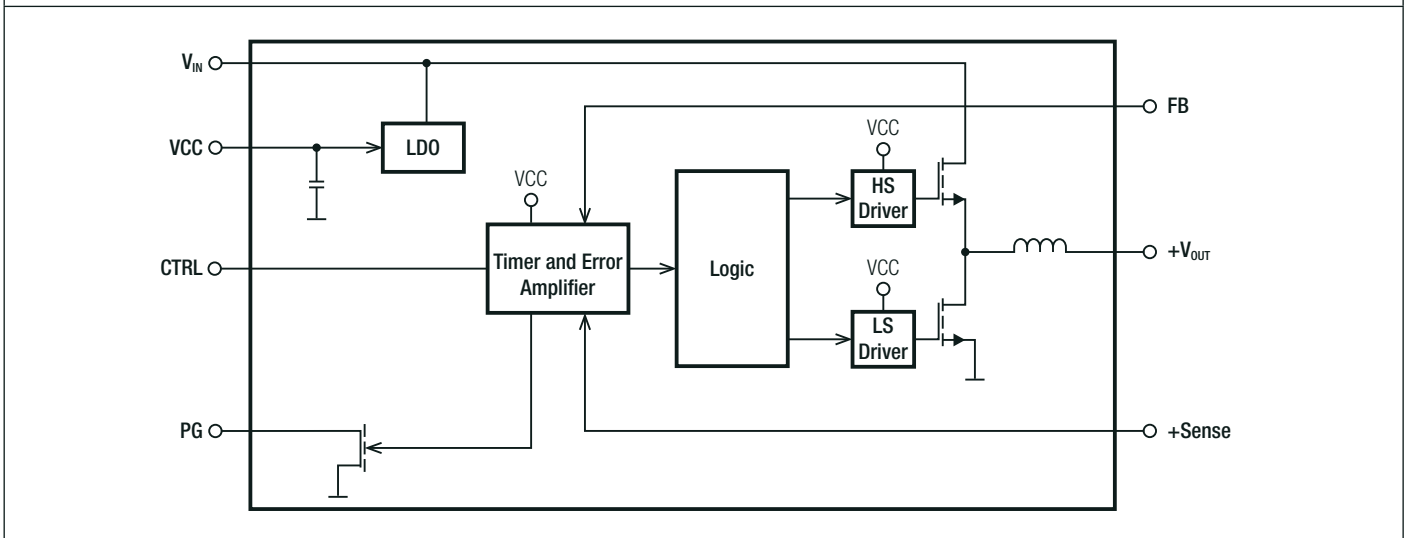

PACKAGING INFORMATION

Parameter	Type	Value
Packaging Dimension (LxWxH)	reel (diameter + width)	Ø177.8 x 12.4mm
	tape and reel (carton)	260.0 x 240.0 x 60.0mm
	moisture barrier bag ("-CT")	100.0 x 100.0 x 30.0mm
Packaging Quantity	tape and reel	500pcs
	tube ("-CT")	10pcs
Tape Width		12mm
Storage Temperature Range		-65°C to +150°C
Storage Humidity	non-condensing	95% RH max.

The product information and specifications may be subject to changes even without prior written notice. The product has been designed for various applications; its suitability lies in the responsibility of each customer. The products are not authorized for use in safety-critical applications without RECOM's explicit written consent. A safety-critical application is an application where a failure may reasonably be expected to endanger or cause loss of life, inflict bodily harm or damage property. The applicant shall indemnify and hold harmless RECOM, its affiliated companies and its representatives against any damage claims in connection with the unauthorized use of RECOM products in such safety-critical applications.