

Data sheet | Item number: 250-411

PCB terminal block; push-button; 0.5 mm²; Pin spacing 2.5 mm; 11-pole;
Push-in CAGE CLAMP®; 0,50 mm²; gray

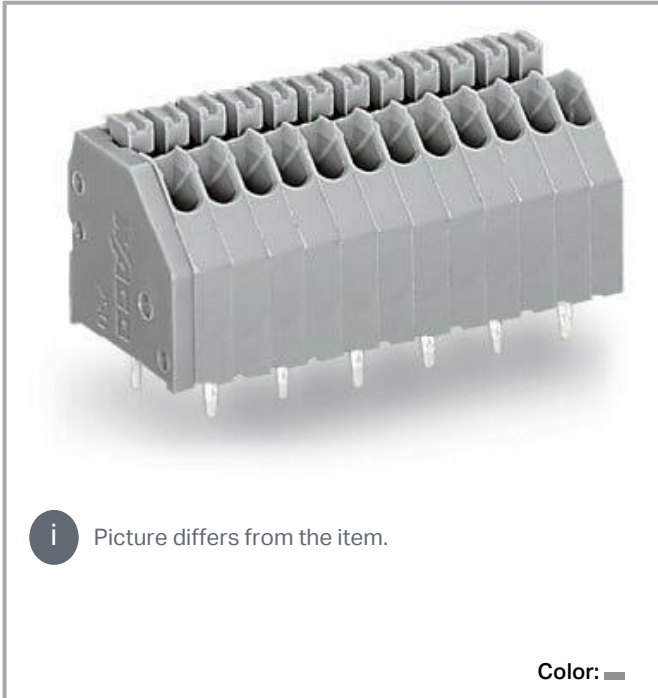

www.wago.com/250-411



i Picture differs from the item.

Color:

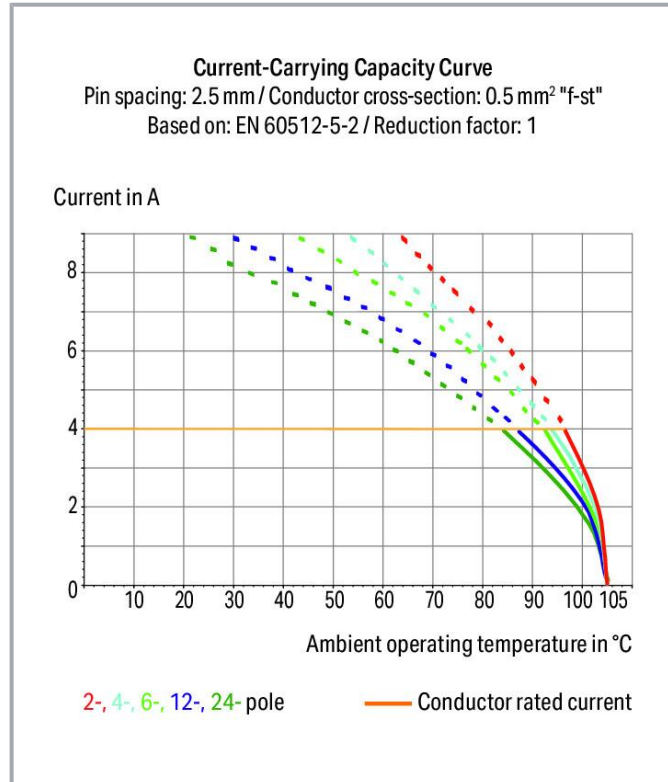

Subject to changes. Please also observe the further product documentation!

WAGO GmbH & Co. KG
Hansastr. 27
32423 Minden
Phone: +49571 887-0 | Fax: +49571 887-169
Email: info.de@wago.com | Web: www.wago.com

Do you have any questions about our products?
We are always happy to take your call at +49 (571) 887-44222.

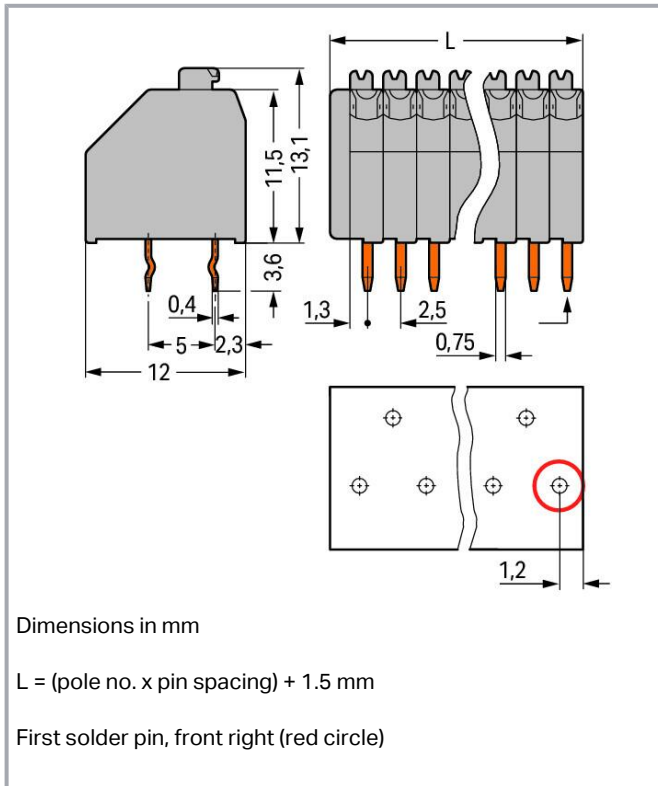

Item description

- Compact PCB terminal strips with push-buttons
- Push-in termination of solid conductors
- Termination/removal of fine-stranded conductors via push-buttons
- 45° conductor entry angle provides easy, space-saving wiring
- Custom color combinations
- Terminal strips also available with spacers upon request

Data

Notes

Variants:

Other pole numbers

Other colors

Mixed-color PCB connector strips

Terminal strips with spacers

Direct marking

Other versions (or variants) can be requested from WAGO Sales or configured at <https://configurator.wago.com/>.

Subject to changes. Please also observe the further product documentation!

WAGO GmbH & Co. KG

Hansastr. 27

32423 Minden

Phone: +49571 887-0 | Fax: +49571 887-169

Email: info.de@wago.com | Web: www.wago.com

Do you have any questions about our products?

We are always happy to take your call at +49 (571) 887-44222.

Electrical data

Ratings per IEC/EN

| Ratings per | IEC/EN 60664-1 |
|-------------------------------|--|
| Nominal voltage (III/3) | 160 V |
| Rated impulse voltage (III/3) | 2.5 kV |
| Rated voltage (III/2) | 160 V |
| Rated impulse voltage (III/2) | 2.5 kV |
| Nominal voltage (II/2) | 320 V |
| Rated surge voltage (II/2) | 2.5 kV |
| Rated current | 4 A |
| Legend (ratings) | (III / 2) \triangleq Overvoltage category III / Pollution degree 2 |

Ratings per UL 1059

| Approvals per | UL 1059 |
|--------------------------------|---------|
| Rated voltage UL (Use Group B) | 300 V |
| Rated current UL (Use Group B) | 5 A |
| Rated voltage UL (Use Group D) | 300 V |
| Rated current UL (Use Group D) | 5 A |

Ratings per CSA

| Approvals per | CSA |
|---------------------------------|-------|
| Rated voltage CSA (Use Group B) | 300 V |
| Rated current CSA (Use Group B) | 5 A |
| Rated voltage CSA (Use Group D) | 300 V |
| Rated current CSA (Use Group D) | 5 A |

Connection data

| | |
|----------------------------|----|
| Connection points | 11 |
| Total number of potentials | 11 |
| Number of connection types | 1 |
| Number of levels | 1 |

Connection 1

| | |
|-----------------------|---------------------|
| Connection technology | Push-in CAGE CLAMP® |
| Actuation type | Push-button |

Subject to changes. Please also observe the further product documentation!



| | |
|---------------------------------------|--|
| Solid conductor | 0.14 ... 0.5 mm ² / 24 ... 20 AWG |
| Fine-stranded conductor | 0.2 ... 0.5 mm ² / 24 ... 20 AWG |
| Conductor diameter | 0.4 ... 0.8 mm / 24 ... 20 AWG |
| Strip length | 8.5 ... 9.5 mm / 0.33 ... 0.37 inches |
| Conductor connection direction to PCB | 45 ° |
| Pole number | 11 |

Physical data

| | |
|--------------------------------------|--------------------------|
| Pin spacing | 2.5 mm / 0.098 inches |
| Width | 29 mm / 1.142 inches |
| Height | 16.7 mm / 0.657 inches |
| Height from the surface | 13.1 mm / 0.516 inches |
| Depth | 12 mm / 0.472 inches |
| Solder pin length | 3.6 mm |
| Solder pin dimensions | 0.4 x 0.75 mm |
| Drilled hole diameter with tolerance | 1.1 ^(+0.1) mm |

Plug-in connection

| | |
|--------------------------------------|----|
| Plugging without loss of pin spacing | No |
|--------------------------------------|----|

PCB contact

| | |
|-------------------------------------|--|
| PCB contact | THT |
| Solder pin arrangement | over the entire terminal strip (staggered) |
| Number of solder pins per potential | 1 |

Material Data

| | |
|-----------------------------|--|
| Note (material data) | Information on material specifications can be found here |
| Color | gray |
| Material group | I |
| Insulation material | Polyamide (PA66) |
| Flammability class per UL94 | V0 |
| Clamping spring material | Copper alloy |
| Contact plating | Tin |
| Fire load | 0.094 MJ |
| Weight | 4 g |

Subject to changes. Please also observe the further product documentation!

Environmental requirements

| | |
|-------------------------|-----------------|
| Limit temperature range | -60 ... +105 °C |
|-------------------------|-----------------|

Commercial data



| | |
|-----------------------|--------------------------------|
| Product Group | 4 (Printed Circuit Connectors) |
| eCl@ss 10.0 | 27-44-04-01 |
| eCl@ss 9.0 | 27-44-04-01 |
| ETIM 8.0 | EC002643 |
| ETIM 7.0 | EC002643 |
| PU (SPU) | 160 (40) pcs |
| Packaging type | box |
| Country of origin | CH |
| GTIN | 4044918643085 |
| Customs tariff number | 85369010000 |

Environmental Product Compliance

| | |
|------------------------|-------------------------|
| RoHS Compliance Status | Compliant, No Exemption |
|------------------------|-------------------------|

Approvals / Certificates

Declarations of conformity and manufacturer's declarations

| Logo | Approval | Additional Approval Text | Certificate name |
|--|--|--------------------------|------------------|
|  | EU-Declaration of Conformity WAGO GmbH & Co. KG | - | - |
|  | UK-Declaration of Conformity WAGO GmbH & Co. KG | - | - |

Optional accessories

Tool

| | |
|--|--|
| Operating tool | |
|  | <p>Item no.: 210-647</p> <p>Operating tool; Blade: 2.5 x 0.4 mm; with a partially insulated shaft; multicoloured</p> <p>www.wago.com/210-647</p> |

Subject to changes. Please also observe the further product documentation!



Item no.: 210-719

Operating tool; Blade: 2.5 x 0.4 mm; with a partially insulated shaft

www.wago.com/210-719

Marking accessories

Marking strip



Item no.: 210-331/250-207

Marking strips; as a DIN A4 sheet; MARKED; 1-48 (100x); Height of marker strip: 2.3 mm/0.091 in; Strip length 182 mm; Horizontal marking; Self-adhesive; white

www.wago.com/210-331/250-207



Item no.: 210-331/250-202

Marking strips; as a DIN A4 sheet; MARKED; 1-16 (400x); Height of marker strip: 2.3 mm/0.091 in; Strip length 182 mm; Horizontal marking; Self-adhesive; white

www.wago.com/210-331/250-202



Item no.: 210-331/250-204

Marking strips; as a DIN A4 sheet; MARKED; 17-32 (400x); Height of marker strip: 2.3 mm/0.091 in; Strip length 182 mm; Horizontal marking; Self-adhesive; white

www.wago.com/210-331/250-204



Item no.: 210-331/250-206

Marking strips; as a DIN A4 sheet; MARKED; 33-48 (400x); Height of marker strip: 2.3 mm/0.091 in; Strip length 182 mm; Horizontal marking; Self-adhesive; white

www.wago.com/210-331/250-206

Testing and measuring

Testing accessories



Item no.: 735-500

WAGO Test pin; 1 mm Ø; 30 V AC / 60 V DC; CAT0; 1 A; 6 mm uninsulated; Test lead for soldering up to 0,5mm²

www.wago.com/735-500

Downloads

Documentation

Additional Information

| | | | |
|------------------------|------------|--------|----------|
| Technical Section | 2019 Apr 3 | pdf | Download |
| Technical explanations | | 2.0 MB | |

CAD/CAE-Data

CAE data

| | | |
|---------------------------|-----|----------|
| EPLAN Data Portal 250-411 | URL | Download |
| ZUKEN Portal 250-411 | URL | Download |

PCB Design

Symbol and Footprint 250-411

Subject to changes. Please also observe the further product documentation!

WAGO GmbH & Co. KG
 Hansastr. 27
 32423 Minden
 Phone: +49571 887-0 | Fax: +49571 887-169
 Email: info.de@wago.com | Web: www.wago.com

Do you have any questions about our products?
 We are always happy to take your call at +49 (571) 887-44222.



[URL](#)

[Download](#)

CAX data for your PCB design, consisting of "schematic symbols and PCB footprints", allow easy integration of the WAGO component into your development environment.

Supported formats:

- Accel EDA 14 & 15
- Altium 6 to current version
- Cadence Allegro
- DesignSpark
- Eagle Libraries
- KiCad
- Mentor Graphics BoardStation
- Mentor Graphics Design Architect
- Mentor Graphics Design Expedition 99 and 2000
- OrCAD 9.X PCB and Capture
- PADS PowerPCB 3, 3.5, 4.X, and 5.X
- PADS PowerPCB and PowerLogic 3.0
- PCAD 2000, 2001, 2002, 2004, and 2006
- Pulsonix 8.5 or newer
- STL
- 3D STEP
- TARGET 3001!
- View Logic ViewDraw
- Quadcept
- Zuken CadStar 3 and 4
- Zuken CR-5000 and CR-8000

PCB Component Libraries (EDA), PCB CAD Library Ultra Librarian

CAD data

2D/3D Models 250-411

[URL](#)

[Download](#)

Environmental Product Compliance

Compliance Search

Environmental Product Compliance 250-411

[URL](#)

[Download](#)

PCB terminal block; push-button; 0.5 mm²; Pin spacing 2.5 mm; 11-pole; Push-in CAGE CLAMP®; 0,50 mm²; gray

Subject to changes. Please also observe the further product documentation!

WAGO GmbH & Co. KG

Hansastr. 27

32423 Minden

Phone: +49571 887-0 | Fax: +49571 887-169

Email: info.de@wago.com | Web: www.wago.com

Do you have any questions about our products?

We are always happy to take your call at +49 (571) 887-44222.

Installation Notes

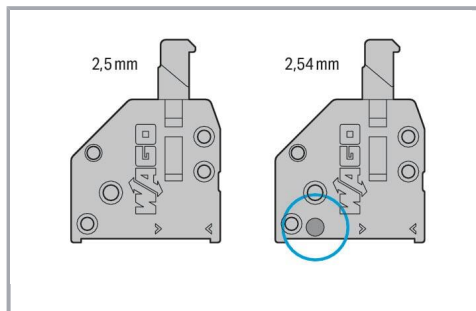

A groove at the back of the terminal strip differentiates between the two pin spacings.

Conductor termination

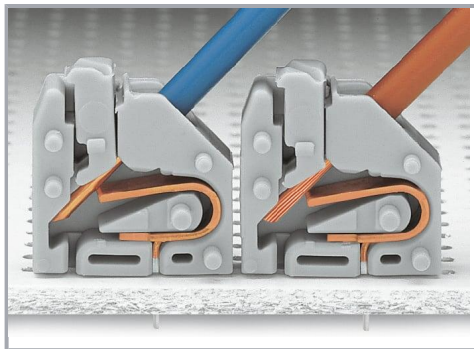

Inserting solid conductors via push-in termination.

Inserting fine-stranded conductors via push-buttons, 250 Series – 3.5 mm pin spacing.

Conductor termination

Subject to changes. Please also observe the further product documentation!

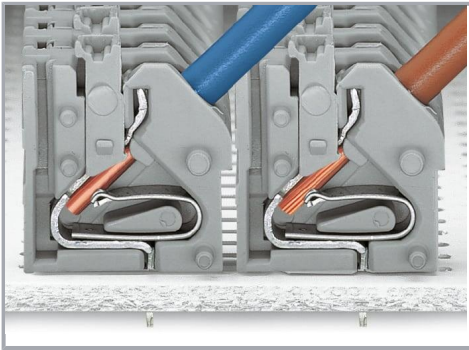

Space-saving wiring, 250 Series – 5 mm pin spacing.

Testing

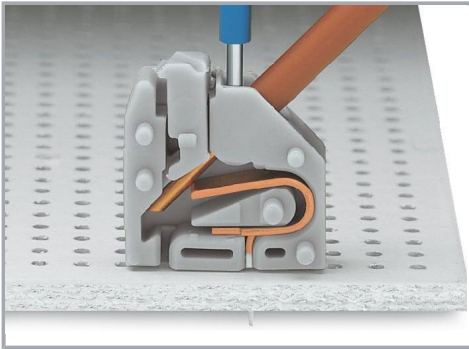

Testing with 11 mm Ø test pin, on the conductor, 250 Series – 2.5 ... 3.5 mm pin spacing.

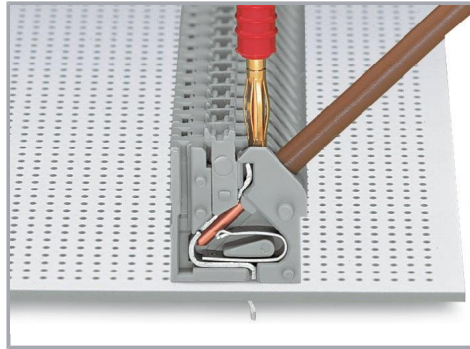

Testing with 2 mm Ø test plug, touch contact, 250 Series – 5 mm pin spacing.

Marking

Subject to changes. Please also observe the further product documentation!

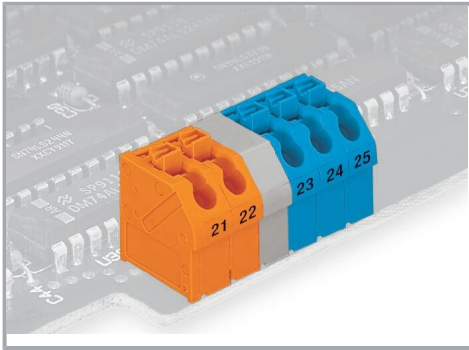

Labeling via self-adhesive strips or direct marking. Mixed-color terminal strips (with or without spacer) are available upon request.

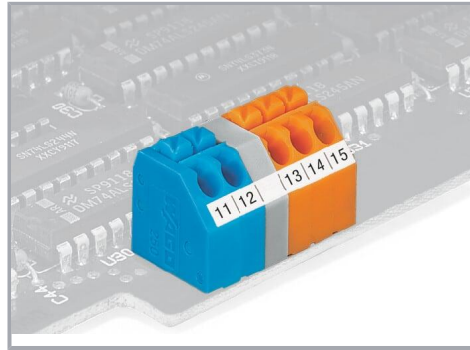

Labeling via self-adhesive strips or direct marking. Mixed-color terminal strips (with or without spacer) are available upon request.

Subject to changes. Please also observe the further product documentation!