

WITHOUT PICK-AND-PLACE CAP

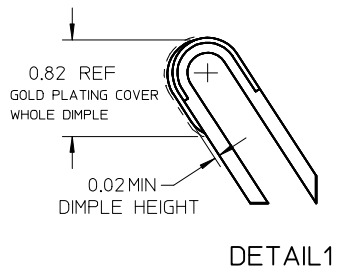

DETAIL1

RECOMMENDED FOOT PRINT

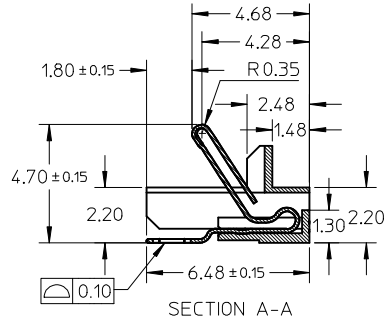
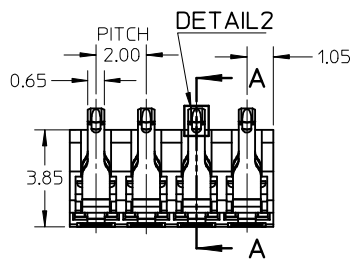
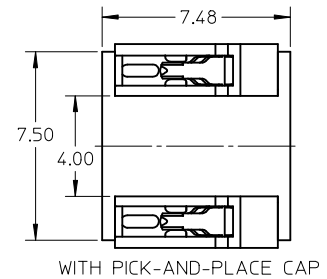

WITH PICK-AND-PLACE CAP

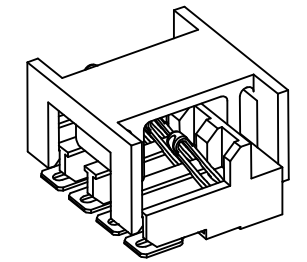

WITH PICK-AND-PLACE CAP

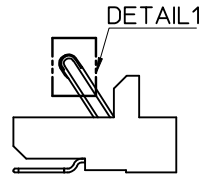
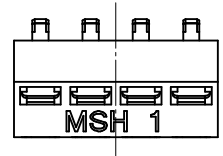
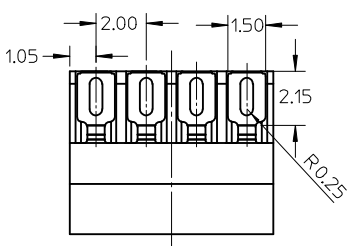

DETAIL1

- NOTE:
- MATERIAL:
 - HOUSING: LCP, 30% GLASS-FILLED, UL 94V-0, COLOR :BLACK
 - CAP: PA46 30% GLASS-FILLED, UL 94V-0, COLOR :BLACK
 - TERMINAL: 0.15MM BeCu C17200 TM06
 - FINISH:
 - CONTACT AREA: 0.75 MICRON GOLD MIN OVER 1.25 MICRON NICKEL MIN.
 - SOLDER AREA: 3.75 MICRON PURE TIN MIN OVER 1.25 MICRON NICKEL MIN.
 - REST AREA: 1.25 MICRON NICKEL MIN.
 - RECOMMENDED NOMINAL DEFLECTION 1.05mm(HORIZONTAL)
 - PRODUCT SPECIFICATION: PS-105029-001
 - PRODUCT COMPLIANT TO ROHS DIRECTIVE 2002/95/EC AND ELV DIRECTIVE 2000/53/EC

NEW RELEASE EC NO: SH2009-0166 DRWN: YPWU CHKD: YLZHUO APPR: HWWANG	QUALITY SYMBOLS ▽=0 ◻=0	GENERAL TOLERANCES (UNLESS SPECIFIED)		DIMENSION STYLE MM ONLY		SCALE 5:1	DESIGN UNITS METRIC	THIRD ANGLE PROJECTION	
			mm	INCH	DRAWN BY YPWU	DATE 2008/01/15	TITLE 2MM PITCH 4 PINS RIGHT ANGLE BATTERY CONN SALES DRAWING		
		4 PLACES	± ---	± ---	CHECKED BY RZHANG	DATE 2008/01/15			
		3 PLACES	± ---	± ---	APPROVED BY HWWANG	DATE 2008/01/16			
			ANGULAR ± ---°		MATERIAL NO. 1050291001	DOCUMENT NO. SD-105029-101	SHEET NO. 1 OF 1		
		DRAFT WHERE APPLICABLE MUST REMAIN WITHIN DIMENSIONS		SIZE A3	THIS DRAWING CONTAINS INFORMATION THAT IS PROPRIETARY TO MOLEX INCORPORATED AND SHOULD NOT BE USED WITHOUT WRITTEN PERMISSION				

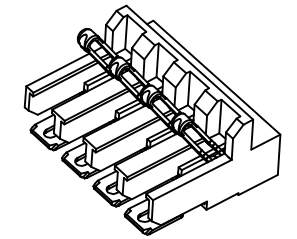
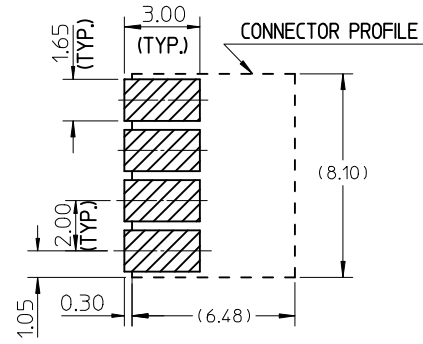
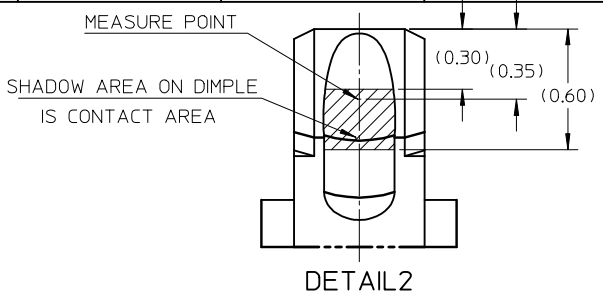
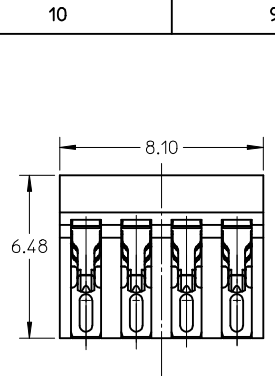

WITHOUT PICK-AND-PLACE CAP

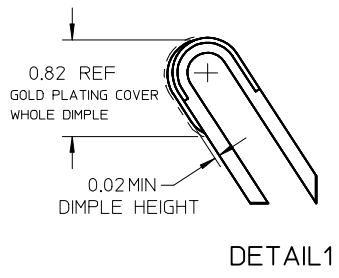
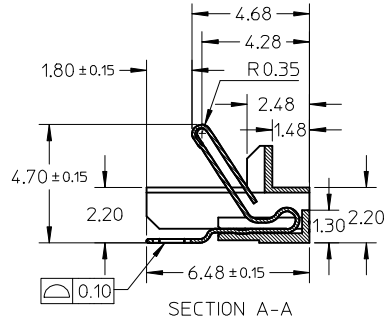
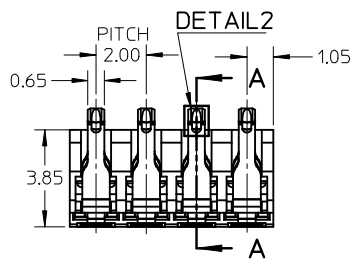

DETAIL1

RECOMMENDED FOOT PRINT

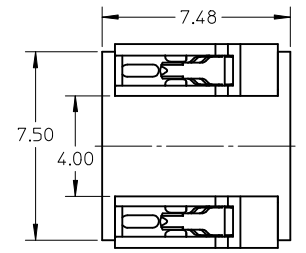

WITH PICK-AND-PLACE CAP

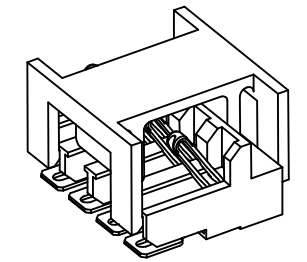

WITH PICK-AND-PLACE CAP

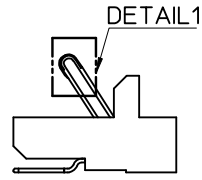
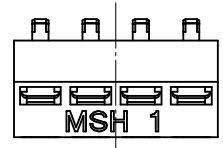
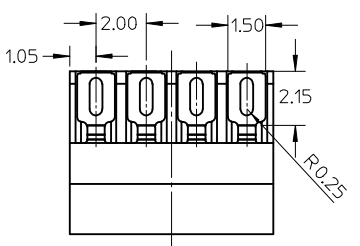

DETAIL1

- NOTE:
- MATERIAL:
 - HOUSING: LCP, 30% GLASS-FILLED, UL 94V-0, COLOR :BLACK
 - CAP: PA46 30% GLASS-FILLED, UL 94V-0, COLOR :BLACK
 - TERMINAL: 0.15MM BeCu C17200 TM06
 - FINISH:
 - CONTACT AREA: 0.75 MICRON GOLD MIN OVER 1.25 MICRON NICKEL MIN.
 - SOLDER AREA: 3.75 MICRON PURE TIN MIN OVER 1.25 MICRON NICKEL MIN.
 - REST AREA: 1.25 MICRON NICKEL MIN.
 - RECOMMENDED NOMINAL DEFLECTION 1.05mm(HORIZONTAL)
 - PRODUCT SPECIFICATION: PS-105029-001
 - PRODUCT COMPLIANT TO ROHS DIRECTIVE 2002/95/EC AND ELV DIRECTIVE 2000/53/EC

NEW RELEASE EC NO: SH2009-0166 DRWN: YPWU CHKD: YLZHUO APPR: HWWANG	2008/10/16 2008/10/20 2008/11/05	QUALITY SYMBOLS ▽=0 ◻=0	GENERAL TOLERANCES (UNLESS SPECIFIED)		DIMENSION STYLE MM ONLY		SCALE 5:1	DESIGN UNITS METRIC	THIRD ANGLE PROJECTION		
				mm	INCH	DRAWN BY YPWU	DATE 2008/01/15	TITLE 2MM PITCH 4 PINS RIGHT ANGLE BATTERY CONN SALES DRAWING			
			4 PLACES	± ---	± ---	CHECKED BY RZHANG	DATE 2008/01/15				
			3 PLACES	± ---	± ---	APPROVED BY HWWANG	DATE 2008/01/16				
			ANGULAR ± ---°		MATERIAL NO. 1050291001	DOCUMENT NO. SD-105029-101		SHEET NO. 1 OF 1			
			DRAFT WHERE APPLICABLE MUST REMAIN WITHIN DIMENSIONS		THIS DRAWING CONTAINS INFORMATION THAT IS PROPRIETARY TO MOLEX INCORPORATED AND SHOULD NOT BE USED WITHOUT WRITTEN PERMISSION						