

Process Sealed Miniature Rocker

## Specifications

Electrical Ratings	5A @ 120VAC, 28VDC 2A @ 250VAC See Contact Options	Dielectric Strength	1500Vrms min
Electrical Life	30,000 cycles typical	Insulation Resistance	>100MΩ min
Contact Resistance	<20mΩ initial @ 2-4VDC, 100mA	Operating Temperature	-40°C to 85°C
		Storage Temperature	-40°C to 85°C
		Sealing Degree	IP67

## Materials

Actuator	6/6 Nylon, Glass Filled, Flame Retardant Heat Stabilized, UL94V-0
Housing	6/6 Nylon, Glass Filled, Flame Retardant Heat Stabilized, UL94V-0
Support Bracket	Brass, Tin Plated
Contacts	Copper Alloy, Silver Plated or Gold Plated
Terminals	Copper Alloy, Silver Plated or Gold Plated

## Ordering Information

1. Series	ASR	1	3	R11	2			C	Q
ASR									
2. Number of Poles									
1 = SPDT									
2 = DPDT									
3 = 3PDT*									
3. Switch Function									
1 = ON-NONE-ON									
2 = ON-NONE-(ON)*									
3 = ON-OFF-ON*									
4 = (ON)-OFF-(ON)*									
5 = ON-OFF-(ON)*									
6 = ON-ON-ON* <sup>†</sup>									
4. Actuator									
R11P / R11 = Rocker, PC mount / Panel mount									
R21P / R21 = Rocker, PC mount / Panel mount									
P13P / P13 = Paddle, PC mount / Panel mount									
P23P / P23 = Paddle, PC mount / Panel mount									
R15P = Rocker, PC mount									
R43P = Rocker, PC mount									
R47P = Rocker, PC mount									
R48P = Rocker, PC mount									
5. Actuator Color									
1 = White									
2 = Black									
3 = Red									
4 = Orange									
5 = Yellow									
6 = Green									
7 = Blue									
8 = Brown									
9 = Gray									
6. Actuator Marking Style									
Blank = No Marking									
A, B, C, D, E, F, G									
7. Actuator Marking Color									
Blank = No marking									
W = White, standard									
B = Black									
8. Terminals									
B = Solder Lugs									
C = PC pin									
D = Quick Connect									
H = Horizontal mount, right angle PC pin									
HS = Horizontal mount, right angle Snap-in									
V = Vertical mount, right angle PC pin									
S20 = PC pin with support bracket									
S25 = PC pin with support bracket									
V20 = Snap-in support bracket									
V25 = Snap-in support bracket									
9. Contacts									
Q = Silver plated									
R = Gold plated									
G = Gold over Silver plated									

\*Available Switch Function 1 only †See Three Way Wiring Section for details

Dimensions are shown for reference purposes only.  
Specifications and availability subject to change without notice.  
ASR Rev B 11/2022

## Switch Function

### SPDT

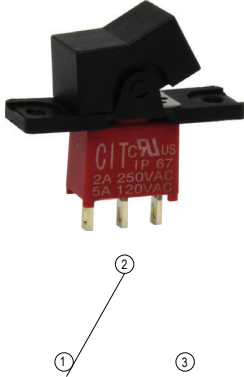

Function	Rocker Position		
1	ON	NONE	ON
2	ON	NONE	(ON)
3	ON	OFF	ON
4	(ON)	OFF	(ON)
5	ON	OFF	(ON)
Terminals	2-3	-	2-1

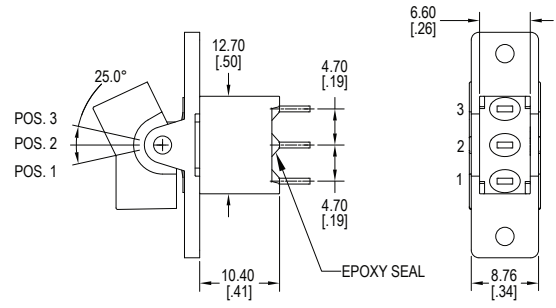

### DPDT

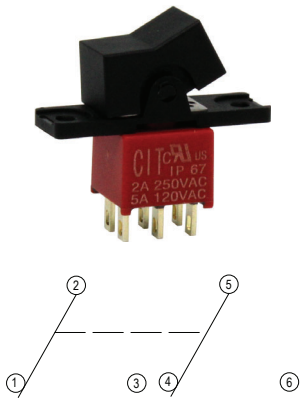

Function	Rocker Position		
1	ON	NONE	ON
2	ON	NONE	(ON)
3	ON	OFF	ON
4	(ON)	OFF	(ON)
5	ON	OFF	(ON)
Terminals	2-3	-	2-1
6	ON	ON	ON
Terminals	2-3 5-6	2-3 5-4	2-1 5-4

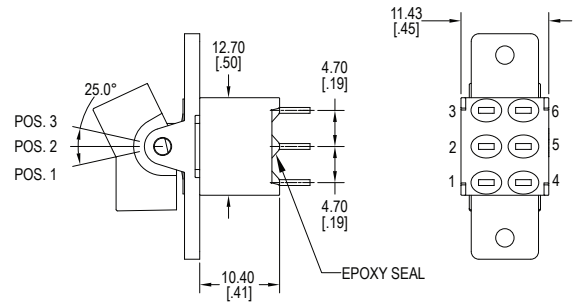

### 3PDT

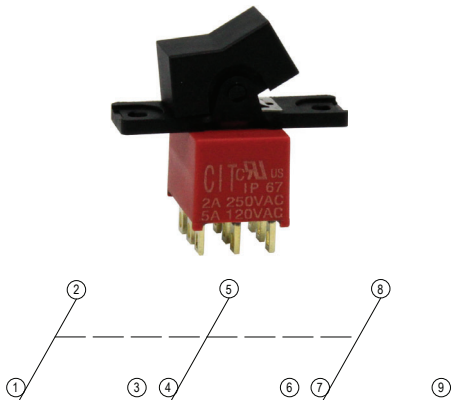

Function	Rocker Position		
1	ON	NONE	ON
2	ON	NONE	(ON)
3	ON	OFF	ON
4	(ON)	OFF	(ON)
5	ON	OFF	(ON)
Terminals	2-3 5-6 8-9	-	2-1 5-4 8-7

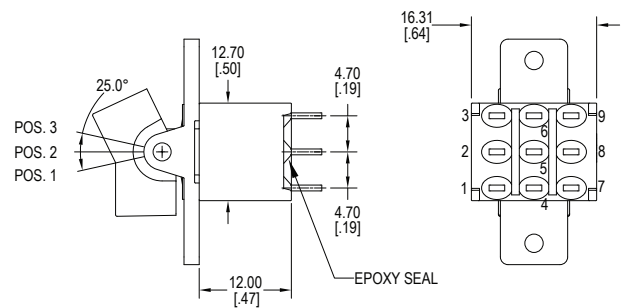

## Actuator Options

**R11P**

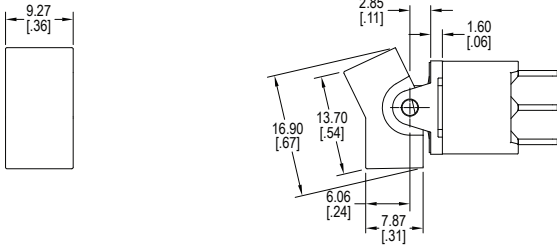

**R11**

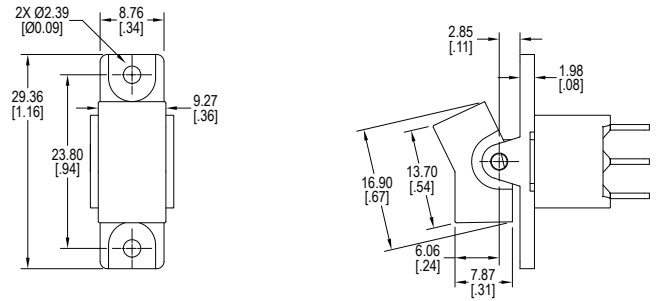

**R21P**

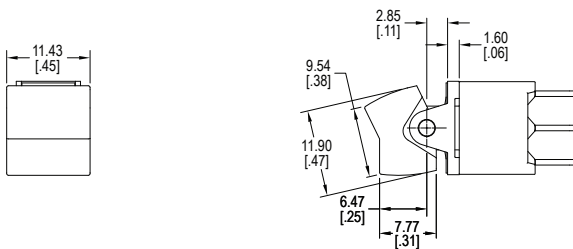

**R21**

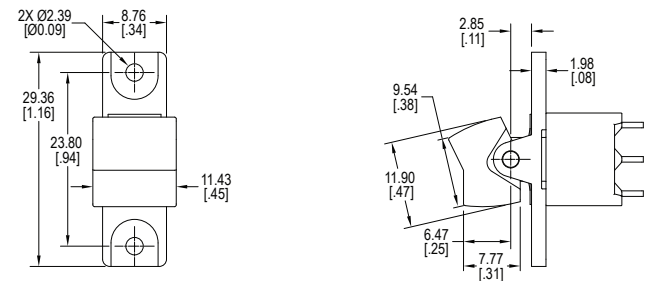

**R15P**

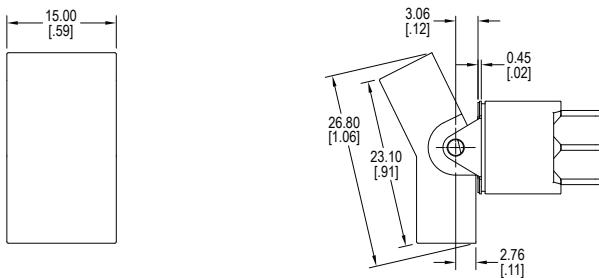

**R43P**

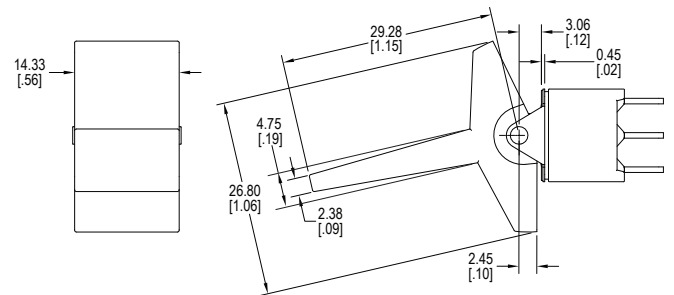

**R47P**

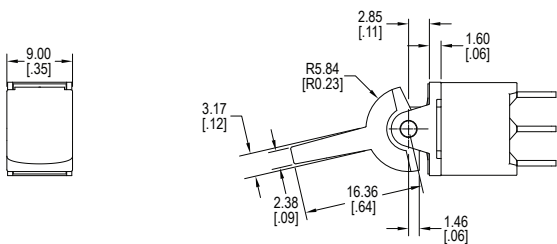

**R48P**

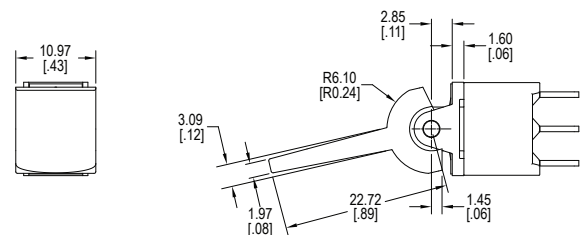

## Actuator Options

**P13P**

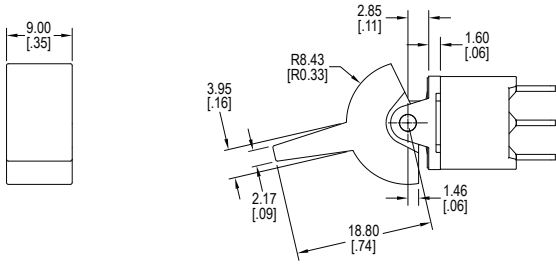

**P13**

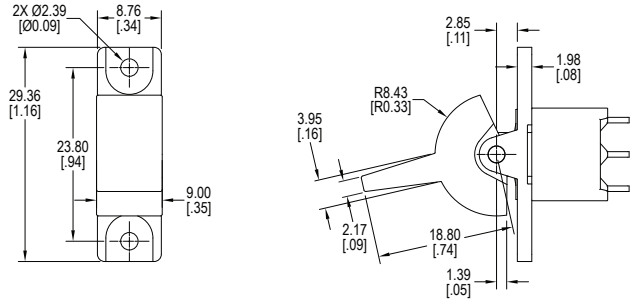

**P23P**

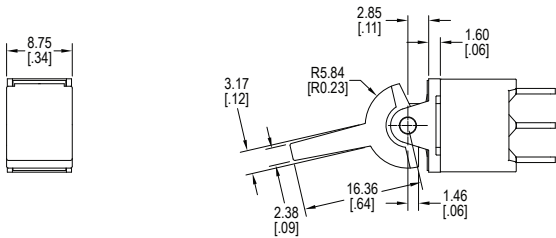

**P23**

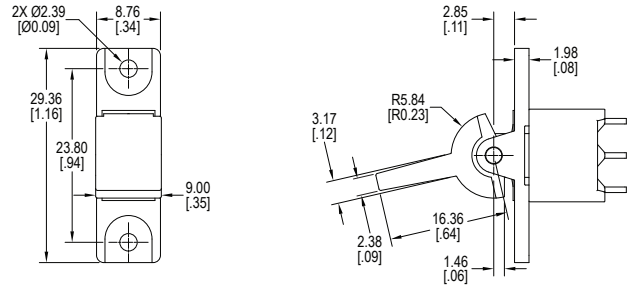

## Panel Mounting

**SPDT**

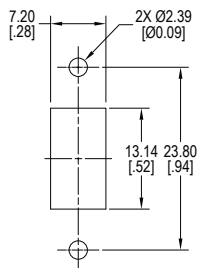

**DPDT**

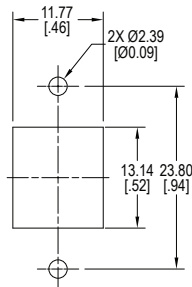

**3PDT**

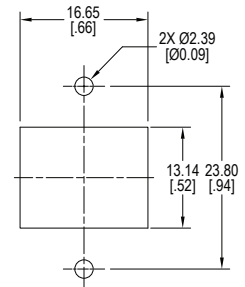

## Actuator Marking

**A**



**B**

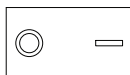

**C**

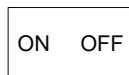

**D**



**E**



**F**

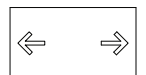

## Terminal Options

### B, Solder Lug – SPDT

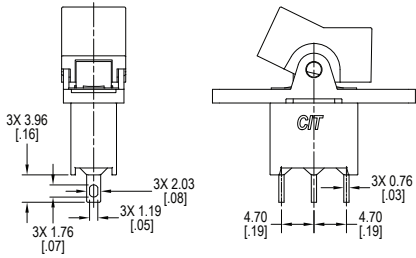

### B, Solder Lug – DPDT

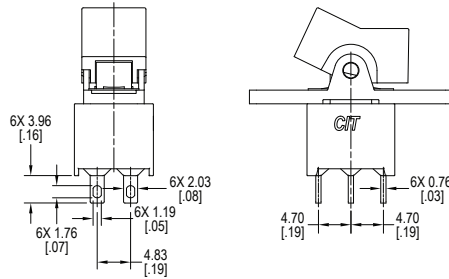

### B, Solder Lug – 3PDT

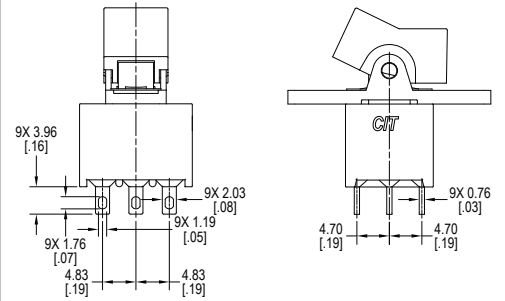

### C, PC Pins – SPDT

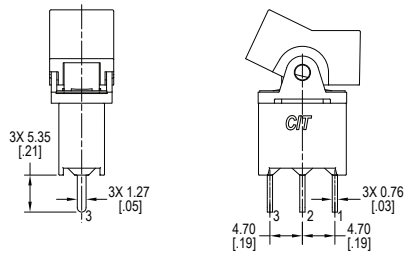

### C, PC Pins – DPDT

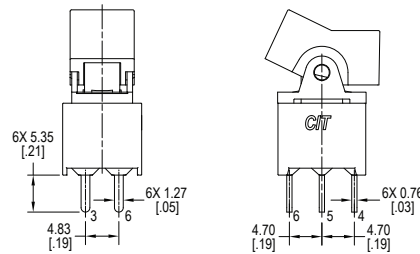

### C, PC Pins – 3PDT

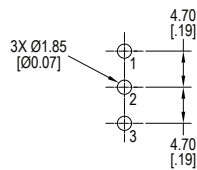
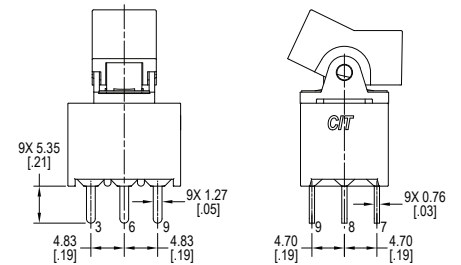

PCB Layout

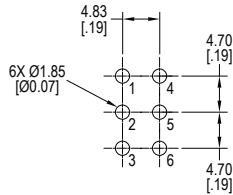

PCB Layout

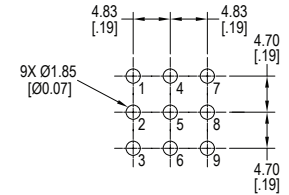

PCB Layout

### D, Quick Connect – SPDT

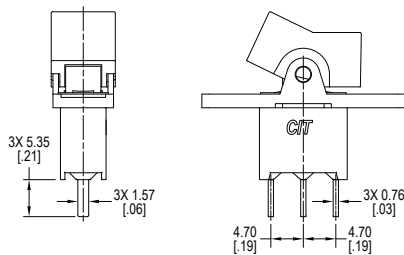

### D, Quick Connect – DPDT

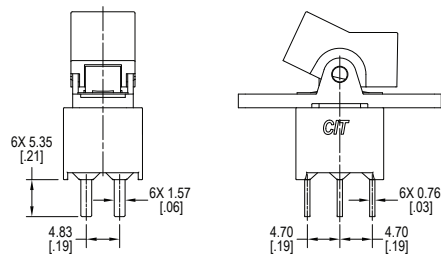

### D, Quick Connect – 3PDT

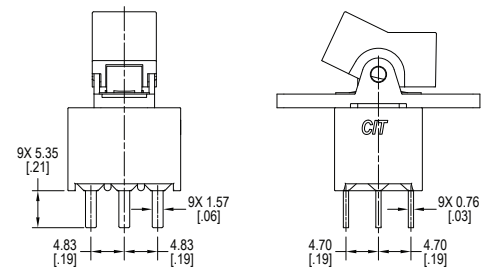

**Terminal Options**

**H / HS, Horizontal mount, right angle PC pins – SPDT**

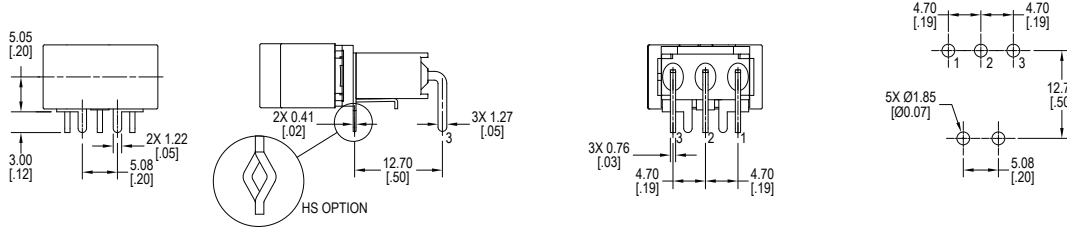

**H / HS, Horizontal mount, right angle PC pins – DPDT**

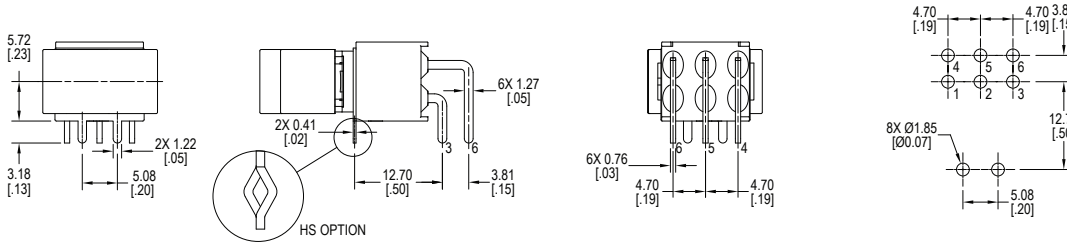

**H / HS, Horizontal mount, right angle PC pins – 3PDT**

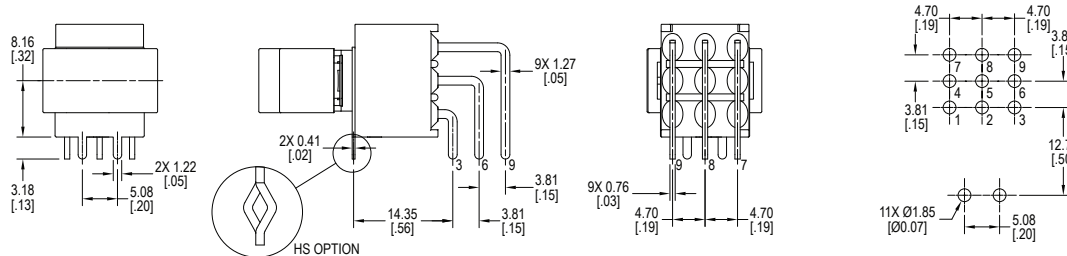

## Terminal Options

### V, Vertical mount, right angle PC pins – SPDT

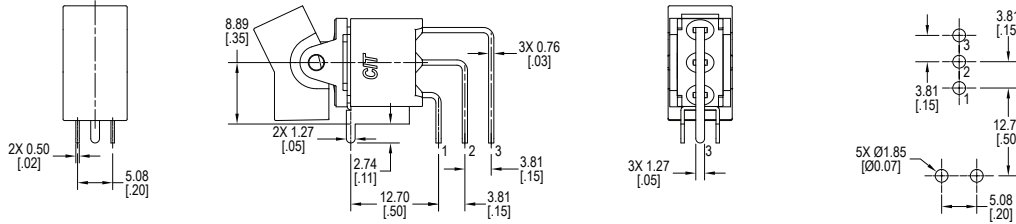

### V, Vertical mount, right angle PC pins – DPDT

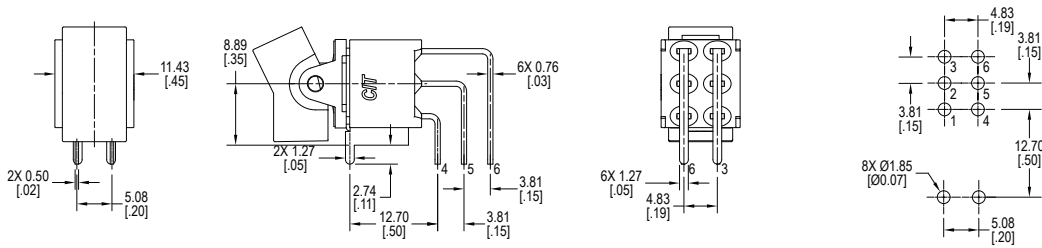

### V, Vertical mount, right angle PC pins – 3PDT

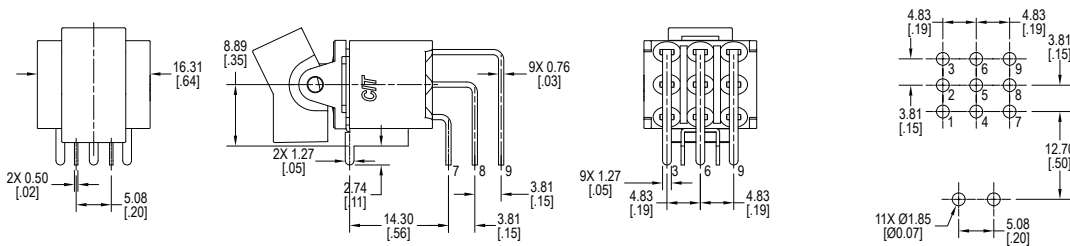

## Terminal Options

### S20 / S25 PC Pin with Support Bracket & V20 / V25 Snap In – SPDT

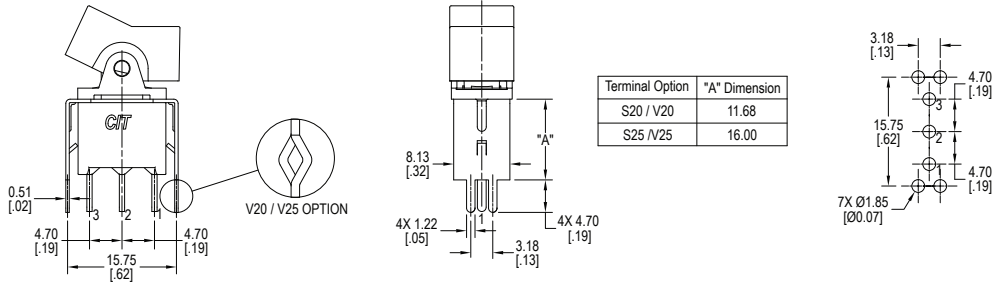

### S20 / S25 PC Pin with Support Bracket & V20 / V25 Snap In – DPDT

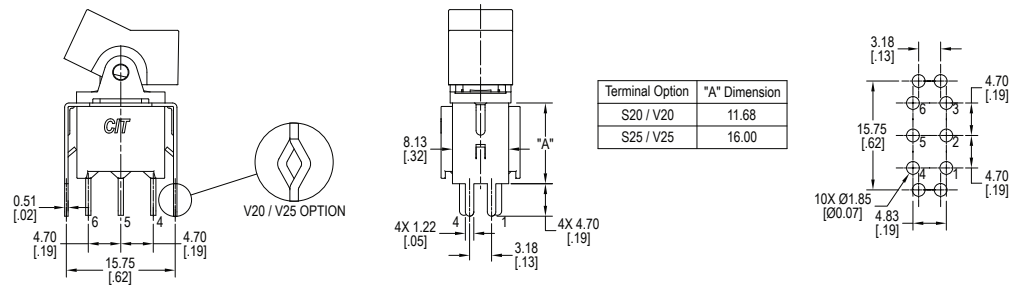

### S20 / S25 PC Pin with Support Bracket & V20 / V25 Snap In – 3PDT

