

# Technical Data Sheet

## 7343/B1C2-APSA/X/MS

### Features

- Popular T-1 3/4 package.
- High efficiency.
- General purpose leads.
- Selected minimum intensities.
- Available on tape and reel.
- The product itself will remain within RoHS compliant version.
- UV resistant epoxy

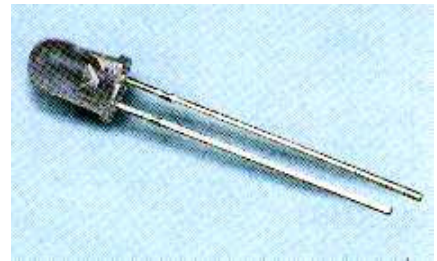

### Descriptions

- The series is specially designed for applications requiring higher brightness.
- The LED lamps are available with different colors, intensities, epoxy colors, etc.

### Applications

- Color Graphic Signs
- Message boards
- Variable message signs (VMS)
- Commercial outdoor advertising

### Device Selection Guide

| LED Part No.         | Chip     |               | Lens Color  | Stopper |
|----------------------|----------|---------------|-------------|---------|
|                      | Material | Emitted Color |             |         |
| 7343/B1C2-APSB/MS    | InGaN    | Blue          | Water clear | No      |
| 7343/B1C21-APSB/P/MS |          |               |             | Yes     |

# Technical Data Sheet

## 7343/B1C2-APSA/X/MS

### Package Dimensions

#### Stopper Type

#### No Stopper Type

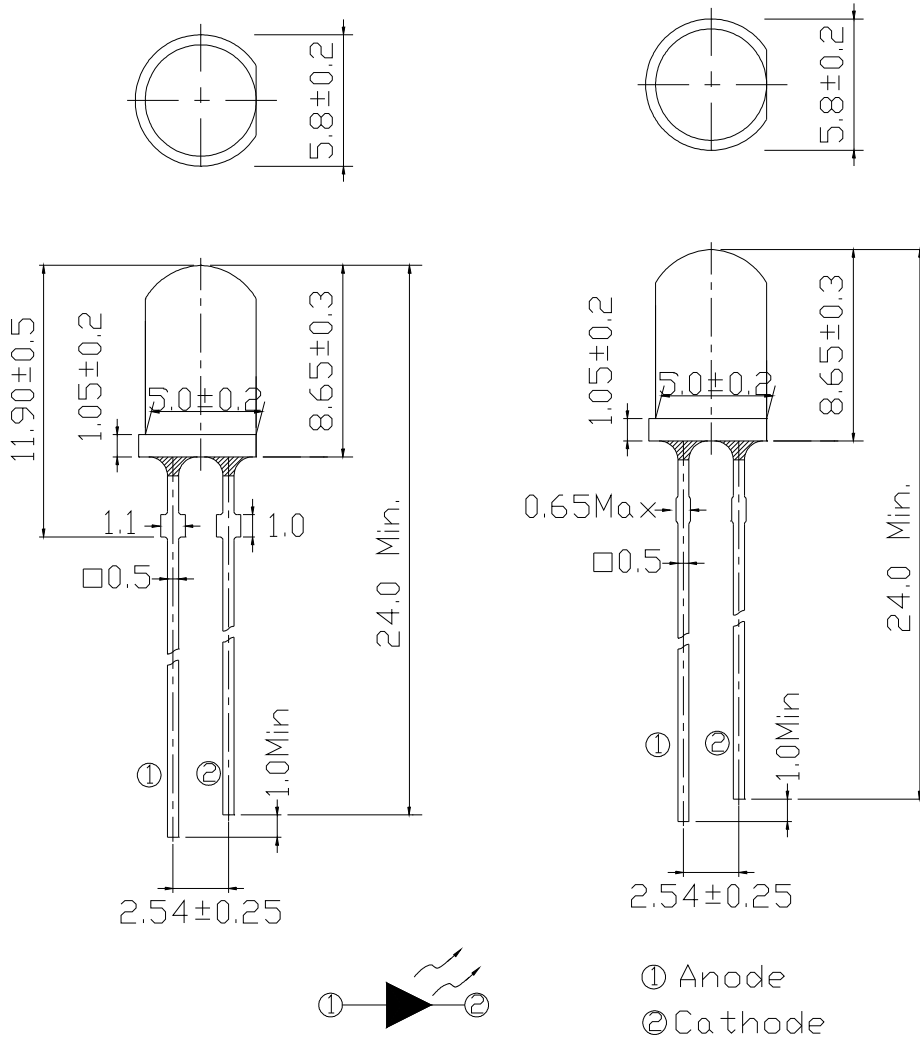

### Notes:

- Other dimensions are in millimeters, tolerance is 0.25mm except being specified.
- Protruded resin under flange is 1.5mm Max LED.
- Bare copper alloy is exposed at tie-bar portion after cutting.



# Technical Data Sheet

## 7343/B1C2-APSA/X/MS

### Absolute Maximum Rating ( $T_a=25^{\circ}\text{C}$ )

| Parameter                              | Symbol    | Absolute Maximum Rating | Unit               |
|--|-----------|-------------------------|--------------------|
| Forward Current                        | $I_F$     | 30                      | mA                 |
| Pulse Forward Current (Duty1/10@ 1KHz) | $I_{FP}$  | 100                     | mA                 |
| Operating Temperature                  | $T_{opr}$ | -40 ~ +85               | $^{\circ}\text{C}$ |
| Storage Temperature                    | $T_{stg}$ | -40 ~ +100              | $^{\circ}\text{C}$ |
| Reverse Voltage                        | $V_R$     | 5                       | V                  |
| Electrostatic Discharge                | ESD       | 1K                      | V                  |
| Soldering Temperature                  | $T_{sol}$ | 260 $\pm$ 5             | $^{\circ}\text{C}$ |
| Power Dissipation                      | $P_d$     | 110                     | mW                 |

Notes: Soldering time  $\leq$  5 seconds.

### Electro-Optical Characteristics ( $T_a=25^{\circ}\text{C}$ )

| Parameter             | Symbol          | Min. | Typ. | Max. | Unit          | Condition         |
|-----------------------|-----------------|------|------|------|---------------|-------------------|
| Radiometric Intensity | $I_v$           | 2850 | 4500 | 7150 | mcd           | $I_F=20\text{mA}$ |
| Viewing Angle         | $2\theta_{1/2}$ | ---- | 15   | ---- | deg           |                   |
| Peak Wavelength       | $\lambda_p$     | ---- | 468  | ---- | nm            |                   |
| Dominant Wavelength   | $\lambda_d$     | 465  | 470  | 475  |               |                   |
| Spectrum Half width   | $\Delta\lambda$ | ---- | 35   | ---- |               |                   |
| Forward Voltage       | $V_F$           | 2.8  | 3.2  | 3.6  | V             |                   |
| Reverse Current       | $I_R$           | ---- | ---- | 50   | $\mu\text{A}$ | $V_R=5\text{V}$   |



# Technical Data Sheet

## 7343/B1C2-APSA/X/MS

### Rank Combination ( $I_F=20mA$ )

| Rank               | P         | Q         | R         | S         |
|--------------------|-----------|-----------|-----------|-----------|
| Luminous Intensity | 2850~3600 | 3600~4500 | 4500~5650 | 5650~7150 |

\*Measurement Uncertainty of Luminous Intensity:  $\pm 15\%$

Unit: :mcd

| Rank            | 0       | 1       | 2       | 3       |
|-----------------|---------|---------|---------|---------|
| Forward Voltage | 2.8~3.0 | 3.0~3.2 | 3.2~3.4 | 3.4~3.6 |

\*Measurement Uncertainty of Forward Voltage:  $\pm 0.1V$

Unit:V

| Rank                | 1       | 2       |
|---------------------|---------|---------|
| Dominant Wavelength | 465~470 | 470~475 |

\*Measurement Uncertainty of Dominant Wavelength  $\pm 1.0nm$

Unit:nm

# Technical Data Sheet

## 7343/B1C2-APSA/X/MS

### Typical Electro-Optical Characteristics Curves

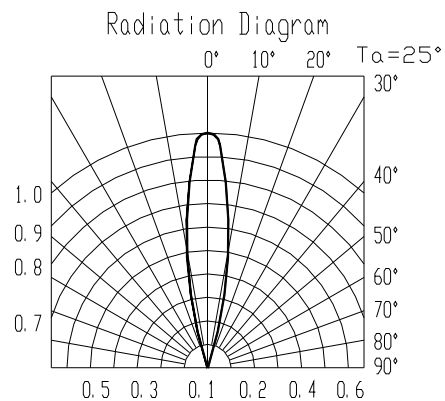
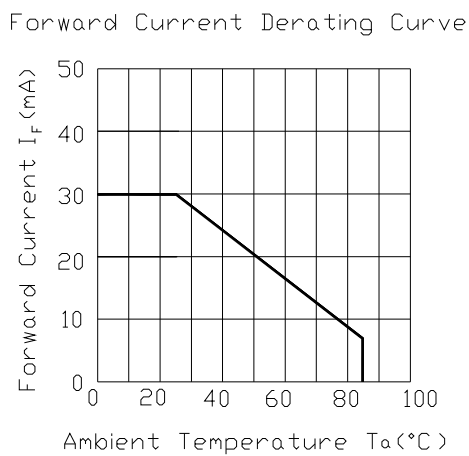
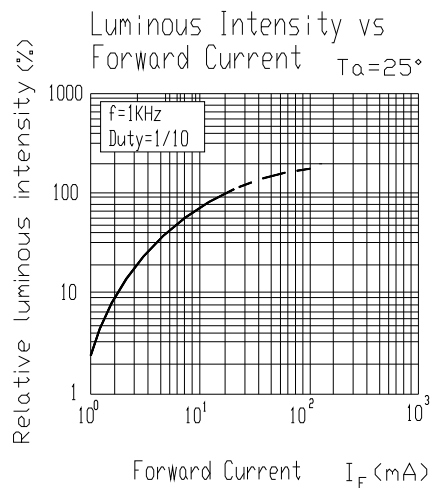
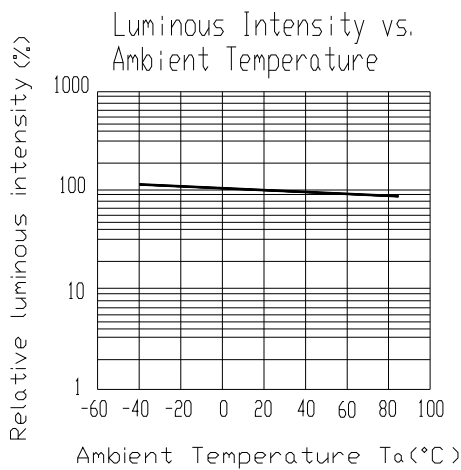
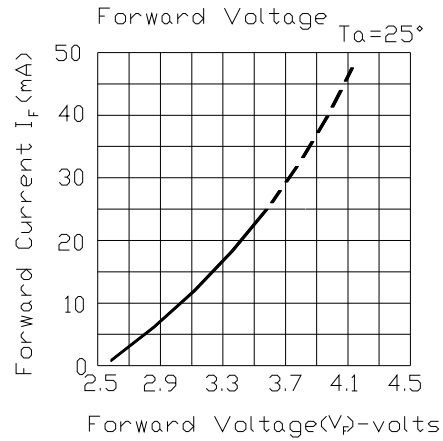
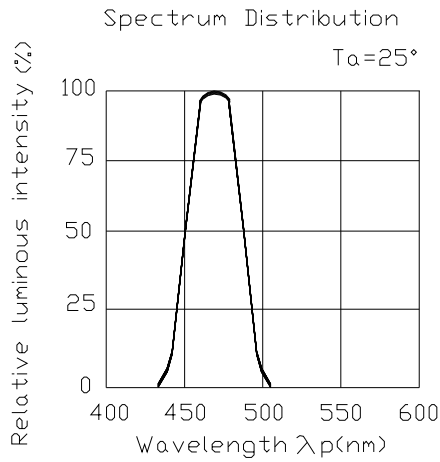



# Technical Data Sheet

**7343/B1C2-APSA/X/MS**

## Packing Quantity Specification

1.500PCS/1Bag , 5Bags/1Box

2.10Boxes/1Carton

## Label Form Specification

|   |      |
|---|------|
| <b>EVERLIGHT</b>  |      |
| CPN:  |      |
| P/N:  |      |
|    | RoHS |
| 7343/B1C2-APSA/X/MS   |      |
| QTY :   | CAT: |
|    | HUE: |
| LOT NO :  | REF: |
|  |      |
| MADE IN TAIWAN  |      |

CPN: Customer's Production Number

P/N : Production Number

QTY: Packing Quantity

CAT: Ranks of Luminous and Forward Voltage

HUE: Ranks of Dominant Wavelength

REF: Reference

LOT No: Lot Number

MADE IN TAIWAN: Production Place



# Technical Data Sheet

## 7343/B1C2-APSA/X/MS

### Notes

1. Above specification may be changed without notice. EVERLIGHT will reserve authority on material change for above specification.
2. When using this product, please observe the absolute maximum ratings and the instructions for using outlined in these specification sheets. EVERLIGHT assumes no responsibility for any damage resulting from use of the product which does not comply with the absolute maximum ratings and the instructions included in these specification sheets.
3. These specification sheets include materials protected under copyright of EVERLIGHT corporation. Please don't reproduce or cause anyone to reproduce them without EVERLIGHT's consent.
4. Soldering Condition

Careful attention should be paid during soldering. When soldering, leave more than 3mm from solder joint to case, and soldering beyond the base of the tie bar is recommended.

Avoiding applying any stress to the lead frame while the LEDs are at high temperature particularly when soldering.

Recommended soldering conditions:

| Hand Soldering       |                                     | DIP Soldering |                          |
|----------------------|-------------------------------------|---------------|--------------------------|
| Temp. at tip of iron | 400°C Max. (30W Max.)               | Preheat temp. | 100°C Max. (60 sec Max.) |
| Soldering time       | 3 sec Max.                          | Bath temp.    | 265 Max.                 |
| Distance             | 3mm Min.(From solder joint to case) | Bath time.    | 5 sec Max.               |
|                      |                                     | Distance      | 3mm Min.                 |

**EVERLIGHT ELECTRONICS CO., LTD.**  
Office: No 25, Lane 76, Sec 3, Chung Yang Rd,  
Tucheng, Taipei 236, Taiwan, R.O.C

Tel: 886-2-2267-2000, 2267-9936  
Fax: 886-2267-6244, 2267-6189, 2267-6306  
<http://www.everlight.com>