

# KEP-BS SERIES

## THREE PHASE HIGH PERFORMANCE EMI FILTER

### BOOKSHELF TYPE SINGLE STAGE WYE CONFIGURATION

#### INTRODUCTION

Bookshelf design for motor drive applications requiring minimum space and convenient installation with high performance at significant interference levels

#### APPLICATION

- Industrial Automation
- HVAC
- CNC Machines
- Robotics

#### FEATURES

- 3 Phase filters for Drives/Invertors
- Bookshelf Design
- Chassis Mounting with Neutral

#### APPROVALS AND COMPLIANCE

- UL Recognised
- CSA Certified



STANDARD



NEW-DIN RAIL

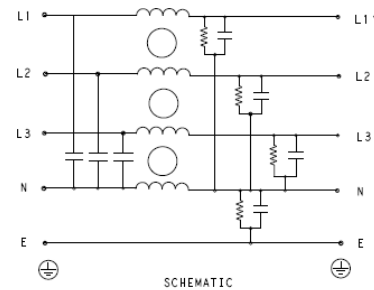

#### Specifications

Electrical Characteristics	
Maximum Continuous Operating Voltage	440/520VAC
Current Ratings	7A to 150A @40°C, Din Mount 7A to 100A @40°C
Operating Frequency	50/60Hz
High Potential Test Voltage -440VAC	Line to Ground 2632VDC for 1 Minute
	Line to Line 1892VDC for 1 Minute
High Potential Test Voltage -520VAC	Line to Ground 2856VDC for 1 Minute
	Line to Line 2236VDC for 1 Minute
Overload Capability	135% of Rated current for 15 minutes

## KEP-BS Series

Three Phase High Performance EMI Filter

Functional Characteristics	
Operating Temperature Range	-25°C to +85°C
Climatic Category	25/85/21
Termination (Depends on Current Rating)	Shock Proof
Flammability Corresponding to	UL 94 V-0

Reference Standards	
Design Corresponding to	UL 60939-3 and CSA 22.2 No.8-13

### Selection Table - Standard Version



TE Ordering Number	Catalog Number	Rated Current @40°C	Rated Voltage @40°C	Leakage Current (mA)	Weight (Kgs)	Termination 
2-1609968-7	7KEPS10ABSW	7A	440 VAC	5	0.8	4
3-1609968-0	16KEPS10ABSW	16A	440 VAC	5	0.9	4
3-1609968-1	30KEPS10ABSW	30A	440 VAC	5	1.2	4
3-1609968-2	42KEPS10ABSW	42A	440 VAC	6	1.2	10
3-1609968-3	55KEPS10ABSW	55A	440 VAC	6	1.6	10
3-1609968-4	75KEPS10ABSW	75A	440 VAC	6	2	16
3-1609968-5	100KEPS10ABSW	100A	440 VAC	11	2.2	25
3-1609968-6	125KEPS10ABSW	120A	440 VAC	11	4	50
3-1609968-7	150KEPS10ABSW	150A	440 VAC	11	5	50
5-1609968-7	7KEPS10BBSW	7A	520 VAC	5	0.8	4
6-1609968-0	16KEPS10BBSW	16A	520 VAC	5	0.9	4
6-1609968-1	30KEPS10BBSW	30A	520 VAC	5	1.2	4
6-1609968-2	42KEPS10BBSW	42A	520 VAC	6	1.2	10
6-1609968-3	55KEPS10BBSW	55A	520 VAC	6	1.6	10
6-1609968-4	75KEPS10BBSW	75A	520 VAC	6	2	16
6-1609968-5	100KEPS10BBSW	100A	520 VAC	11	2.2	25
6-1609968-6	125KEPS10BBSW	120A	520 VAC	11	4	50
6-1609968-7	150KEPS10BBSW	150A	520 VAC	11	5	50

# KEP-BS Series

Three Phase High Performance EMI Filter

## Selection Table - Din Rail Mount



NEW

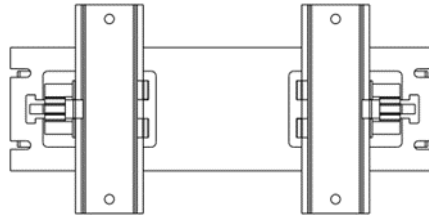

VERTICAL MOUNT

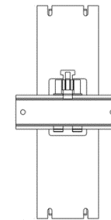

HORIZONTAL MOUNT

Note: Din Rail not supplied

TE Part Number	Catalog Number	Din Type	Rated Current @40°C	Rated Voltage @40°C	Leakage Current (mA)	Weight (Kgs)	Termination 
9-1609968-3	7KEPS10ABSWHM	HORIZONTAL	7A	440 VAC	5	0.9	4
9-1609968-4	16KEPS10ABSWHM	HORIZONTAL	16A	440 VAC	5	1	4
9-1609968-5	30KEPS10ABSWHM	HORIZONTAL	30A	440 VAC	5	1.3	4
9-1609968-6	42KEPS10ABSWHM	HORIZONTAL	42A	440 VAC	6	1.3	10
9-1609968-7	7KEPS10ABSWVM	VERTICAL	7A	440 VAC	5	1.8	4
9-1609968-8	16KEPS10ABSWVM	VERTICAL	16A	440 VAC	5	1.4	4
9-1609968-9	30KEPS10ABSWVM	VERTICAL	30A	440 VAC	5	1.4	4
7-1609969-0	42KEPS10ABSWVM	VERTICAL	42A	440 VAC	6	1.8	10
7-1609969-1	55KEPS10ABSWHM	HORIZONTAL	55A	440 VAC	6	2.2	10
7-1609969-2	75KEPS10ABSWHM	HORIZONTAL	75A	440 VAC	6	2.4	16
7-1609969-3	100KEPS10ABSWHM	HORIZONTAL	100A	440 VAC	11	3.2	25
8-1609969-5	7KEPS10BBSWHM	HORIZONTAL	7A	520 VAC	5	0.9	4
8-1609969-6	16KEPS10BBSWHM	HORIZONTAL	16A	520 VAC	5	1	4
8-1609969-7	30KEPS10BBSWHM	HORIZONTAL	30A	520 VAC	5	1.3	4
8-1609969-8	42KEPS10BBSWHM	HORIZONTAL	42A	520 VAC	6	1.3	10
8-1609969-9	7KEPS10BBSWVM	VERTICAL	7A	520 VAC	5	1.8	4
9-1609969-0	16KEPS10BBSWVM	VERTICAL	16A	520 VAC	5	1.4	4
9-1609969-1	30KEPS10BBSWVM	VERTICAL	30A	520 VAC	5	1.4	4
9-1609969-2	42KEPS10BBSWVM	VERTICAL	42A	520 VAC	6	1.8	10
9-1609969-3	55KEPS10BBSWHM	HORIZONTAL	55A	520 VAC	6	2.2	10
9-1609969-4	75KEPS10BBSWHM	HORIZONTAL	75A	520 VAC	6	2.4	16
9-1609969-5	100KEPS10BBSWHM	HORIZONTAL	100A	520 VAC	11	3.2	25

## KEP-BS Series

Three Phase High Performance EMI Filter

### Connectors Cross Section

	4	10	16	25	50
Wire Section (mm <sup>2</sup> )	4mm <sup>2</sup>	10 mm <sup>2</sup>	16 mm <sup>2</sup>	25 mm <sup>2</sup>	50 mm <sup>2</sup>
Wire Section (AWG)	12AWG	8 AWG	6 AWG	4 AWG	1/0 AWG
Wire Stripping	max 10mm	max 13.5 mm	max 17 mm	max 17 mm	max 20 mm
Max Recommended Torque	0.5 Nm/4.5 in.lbs	1.2 Nm/10.8 in.lbs	2-2.2 Nm/18-19.8 in.lbs	2 Nm/18 in.lbs	6 Nm/54 in.lbs

### Insertion Loss (Typical) – Measured in Closed 50Ω System

		Common Mode 50Ω/50Ω								
		Frequency in MHz								
		0.01	0.05	0.15	0.5	1	3	5	10	30
Current Rating	7A	22	18	48	60	70	65	58	31	11
	16A	20	25	56	64	75	70	60	31	11
	30A	21	23	35	61	67	50	43	37	19
	42A	35	42	55	54	52	48	34	24	10
	55A	32	40	55	56	52	48	34	24	12
	75A	30	35	48	60	64	57	30	22	15
	100A	24	24	29	56	46	50	54	23	12
	125A	25	25	32	55	45	32	28	22	12
	150A	24	25	31	50	41	30	26	21	13

		Differential Mode 50Ω/50Ω								
		Frequency in MHz								
		0.01	0.05	0.15	0.5	1	3	5	10	30
Current Rating	7A	24	22	63	50	67	60	56	70	50
	16A	32	40	63	60	70	65	60	50	60
	30A	28	29	38	75	67	59	48	21	24
	42A	32	40	50	65	62	68	62	40	18
	55A	32	41	52	68	62	68	56	40	16
	75A	27	32	41	56	68	60	49	38	19
	100A	17	20	23	42	40	52	58	20	20
	125A	44	45	49	48	40	31	25	17	16
	150A	42	43	47	48	41	30	24	18	18

# KEP-BS Series

Three Phase High Performance EMI Filter

## Common Mode Insertion Loss (Typical in dB - Refer to table above)

7A

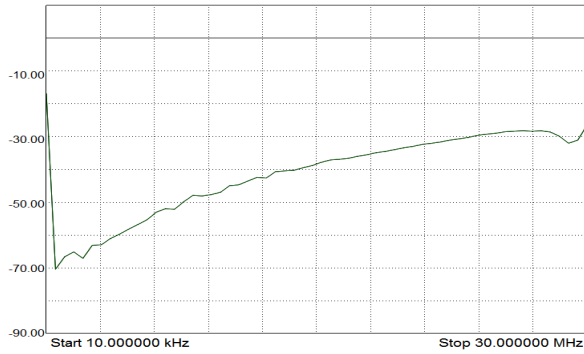

16A

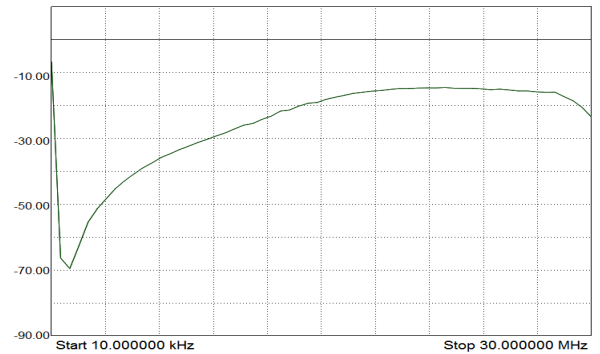

30A

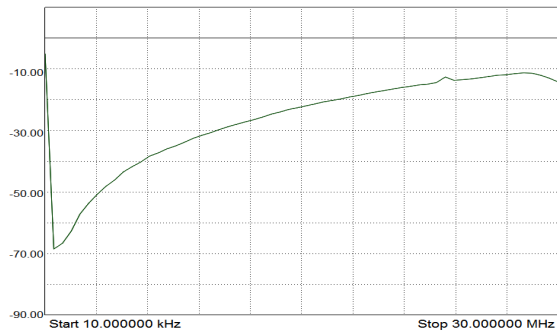

42A

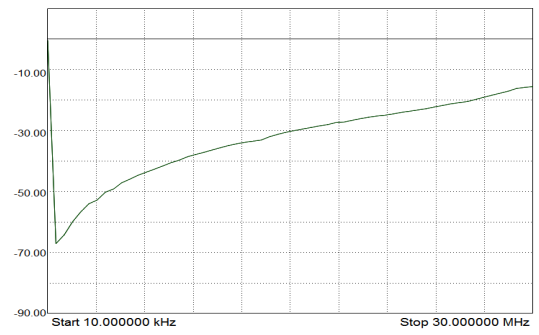

55A

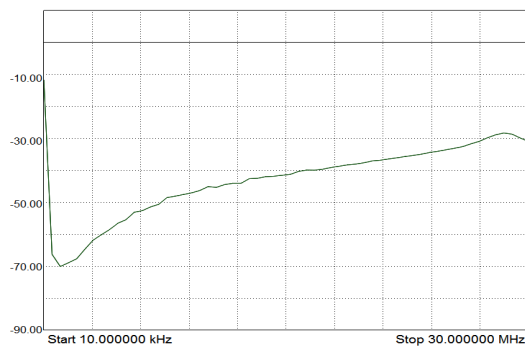

75A

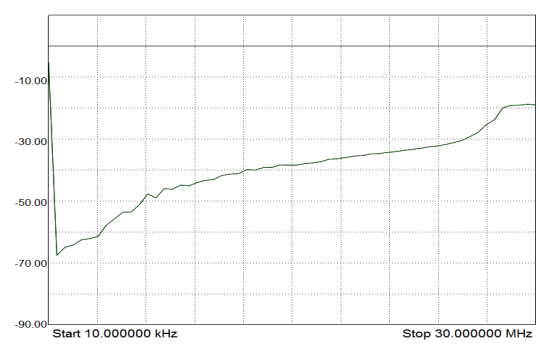

# KEP-BS Series

Three Phase High Performance EMI Filter

## Common Mode Insertion Loss (Typical in dB - Refer to table above)

100A

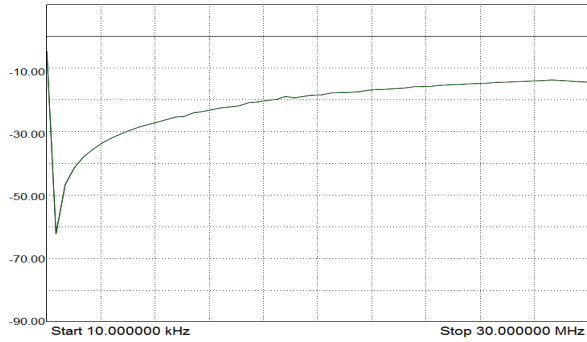

125A

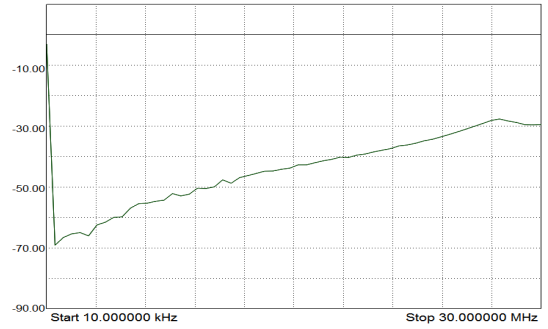

150A

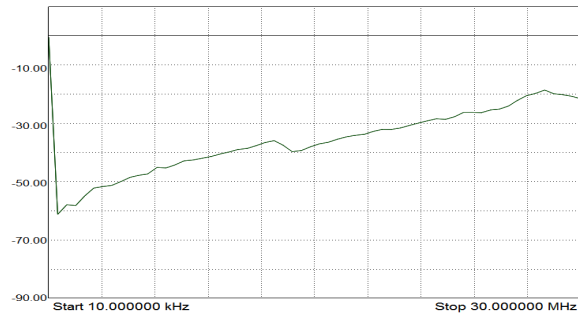

All dimensions in mm; Tolerances according: ISO2768-m

# KEP-BS Series

Three Phase High Performance EMI Filter

## Case Dimensions - Standard Version

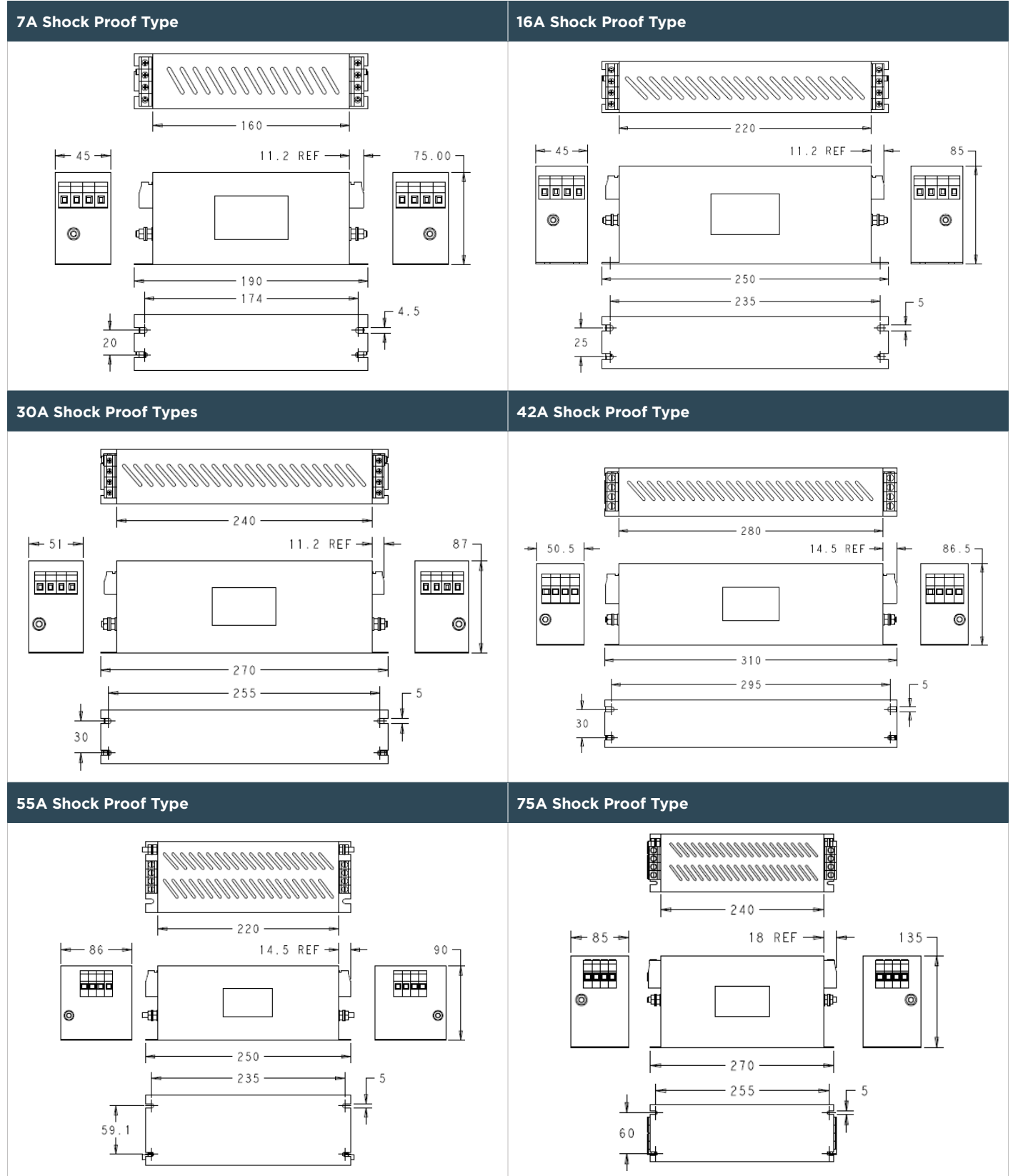

# KEP-BS Series

Three Phase High Performance EMI Filter

## Case Dimensions - Standard Version

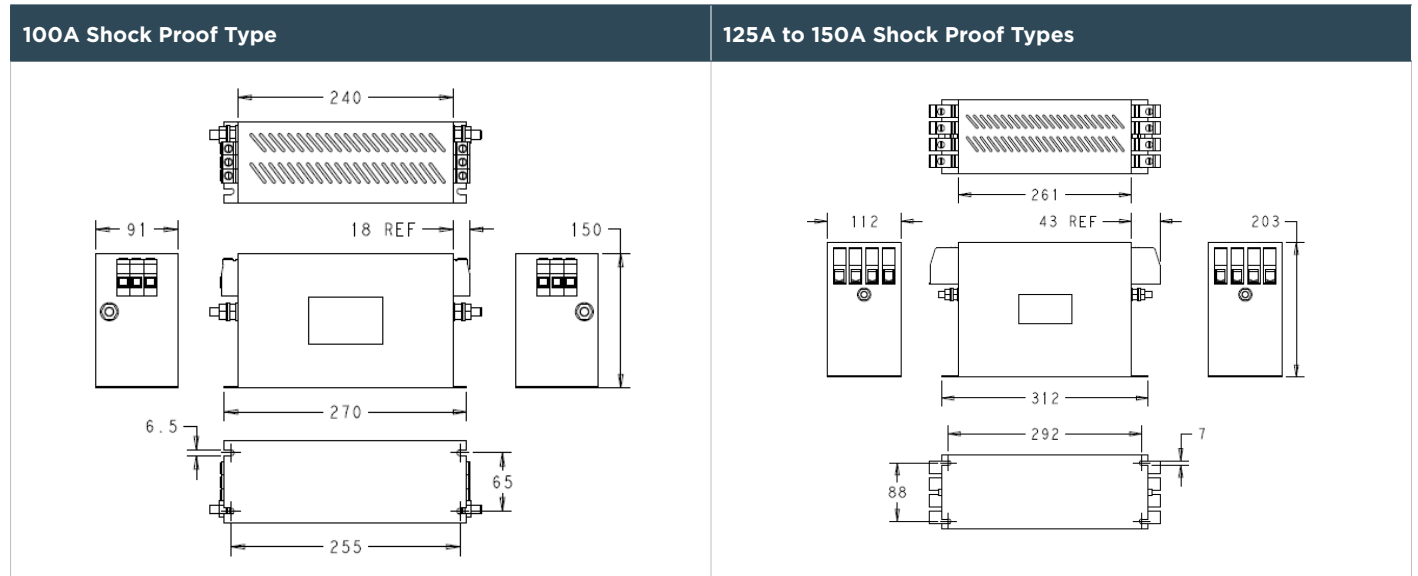

All dimensions in mm; Tolerances according: ISO2768-m



# KEP-BS Series

Three Phase High Performance EMI Filter

## Case Dimensions - Din Rail Mount

### 7A Shock Proof Type - Horizontal Mount

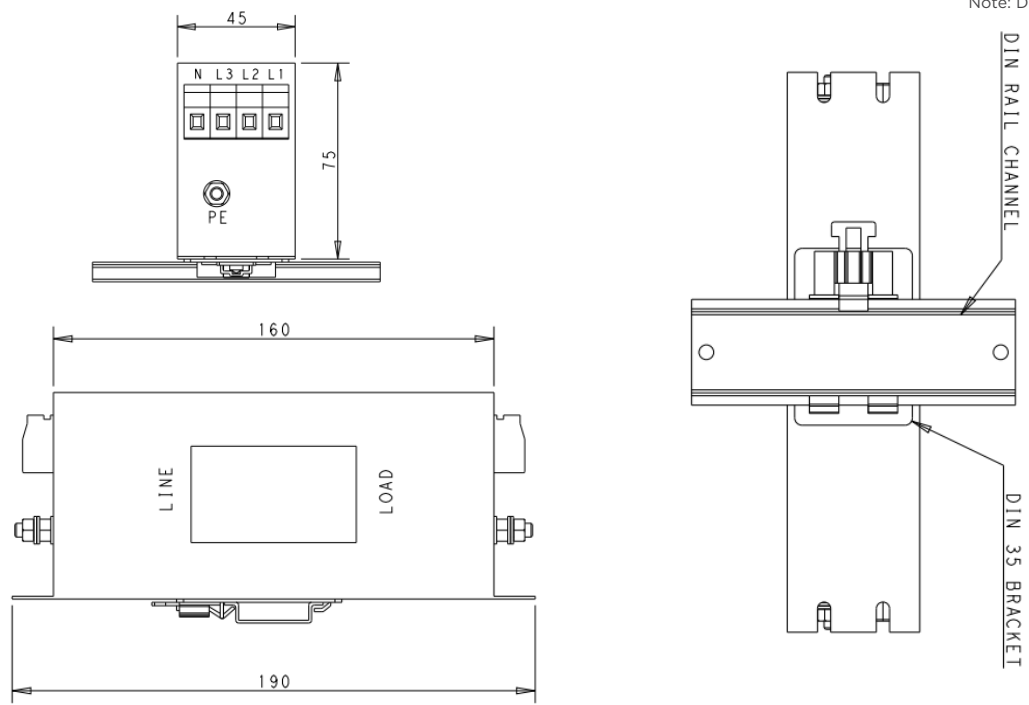

### 7A Shock Proof Type - Vertical Mount

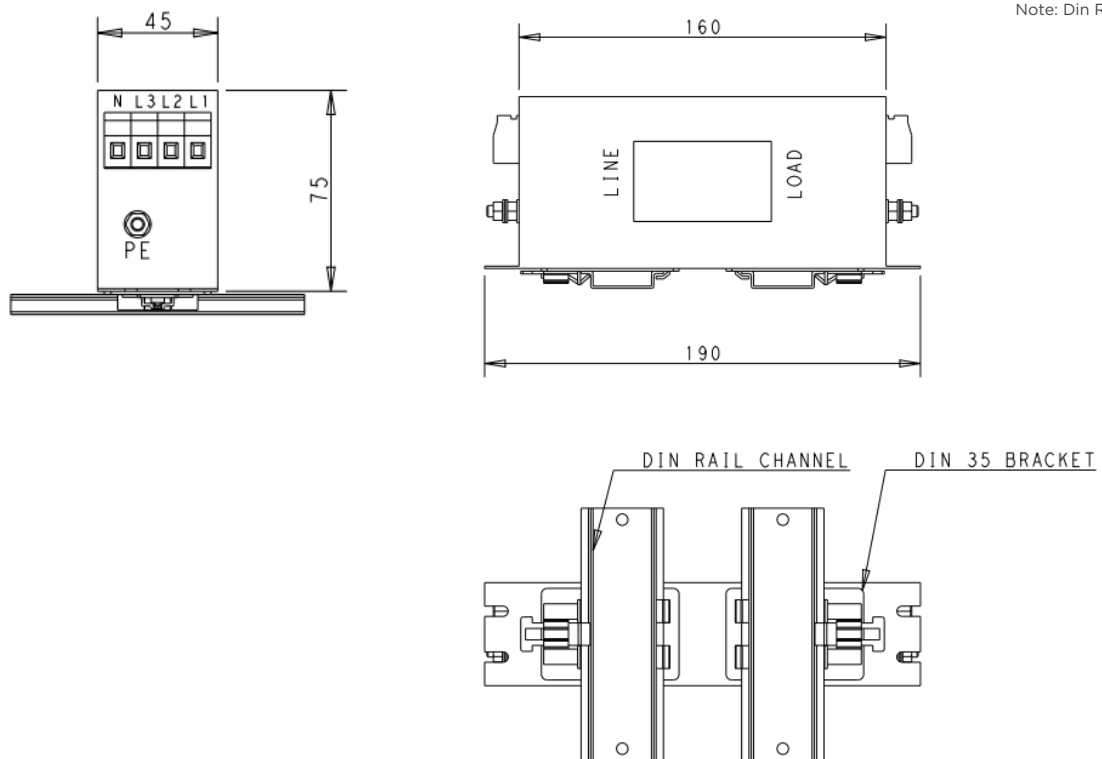

# KEP-BS Series

Three Phase High Performance EMI Filter

## Case Dimensions - Din Rail Mount

### 16A Shock Proof Type - Horizontal Mount

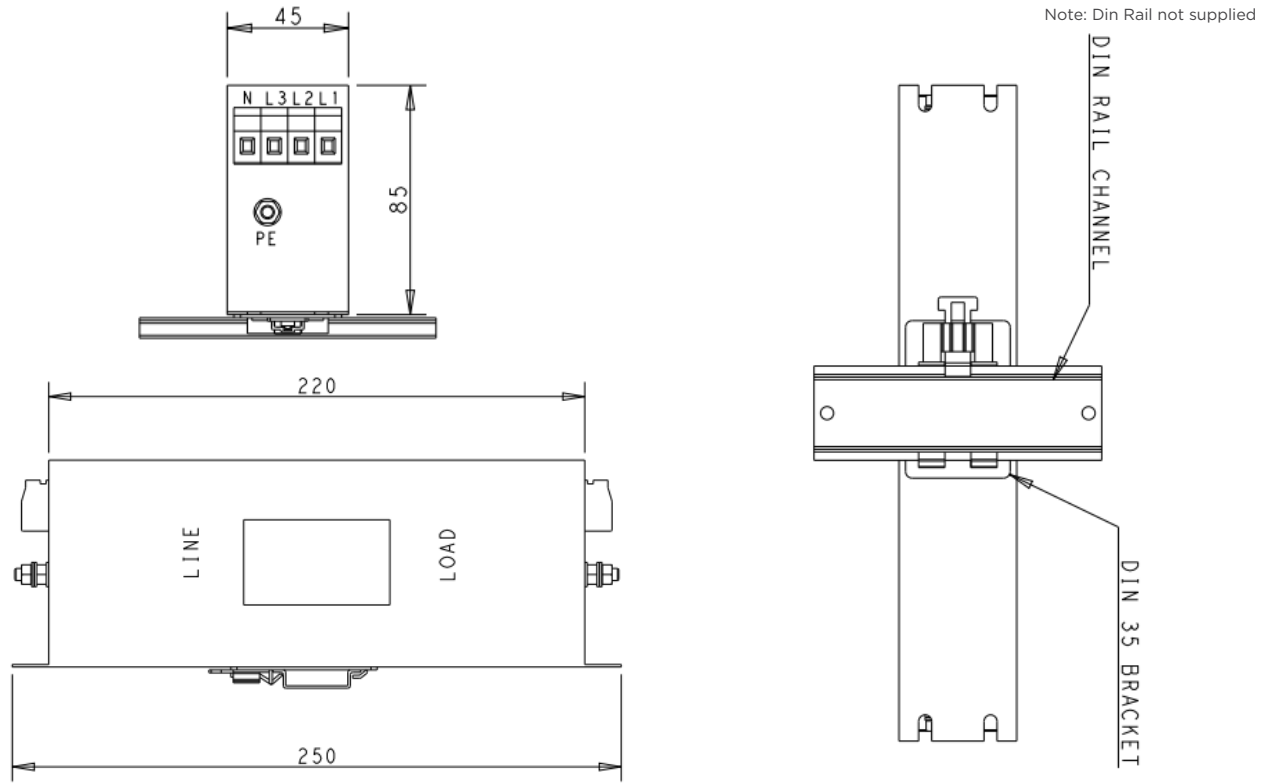

### 16A Shock Proof Type - Vertical Mount

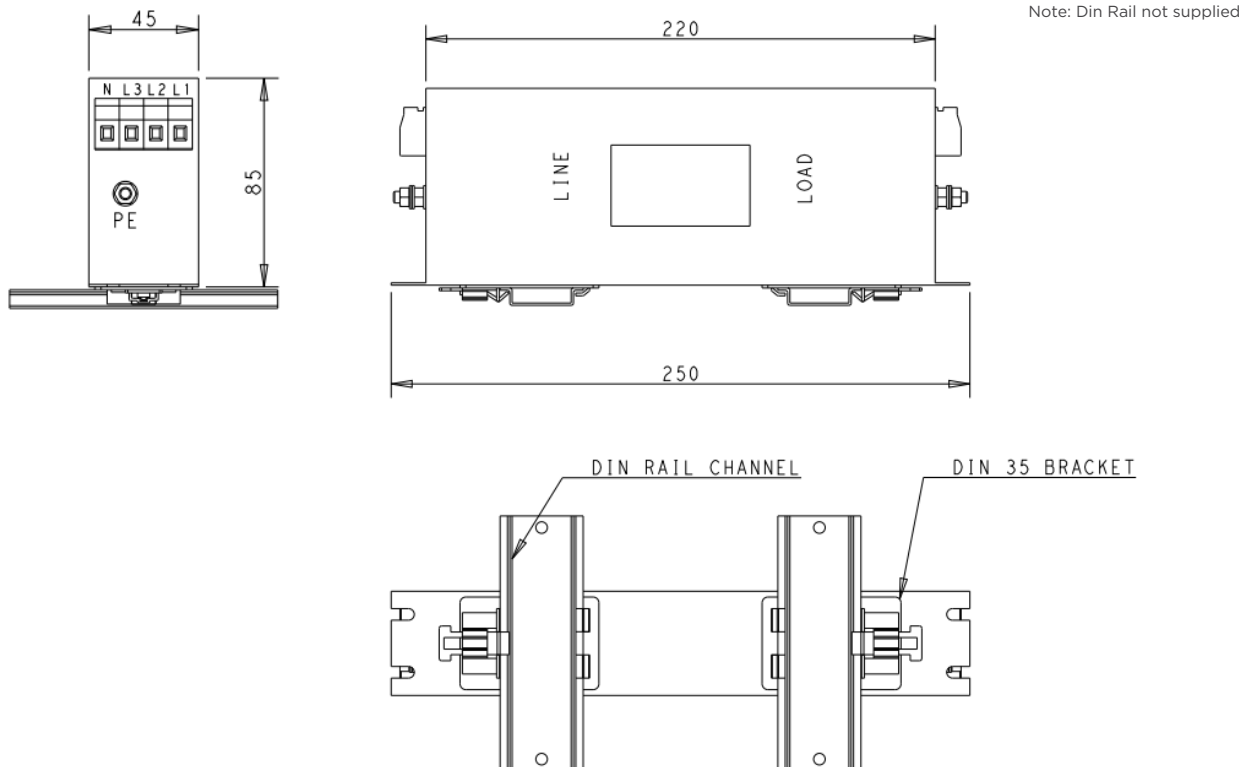

# KEP-BS Series

Three Phase High Performance EMI Filter

## Case Dimensions - Din Rail Mount

### 30A Shock Proof Type - Horizontal Mount

Note: Din Rail not supplied

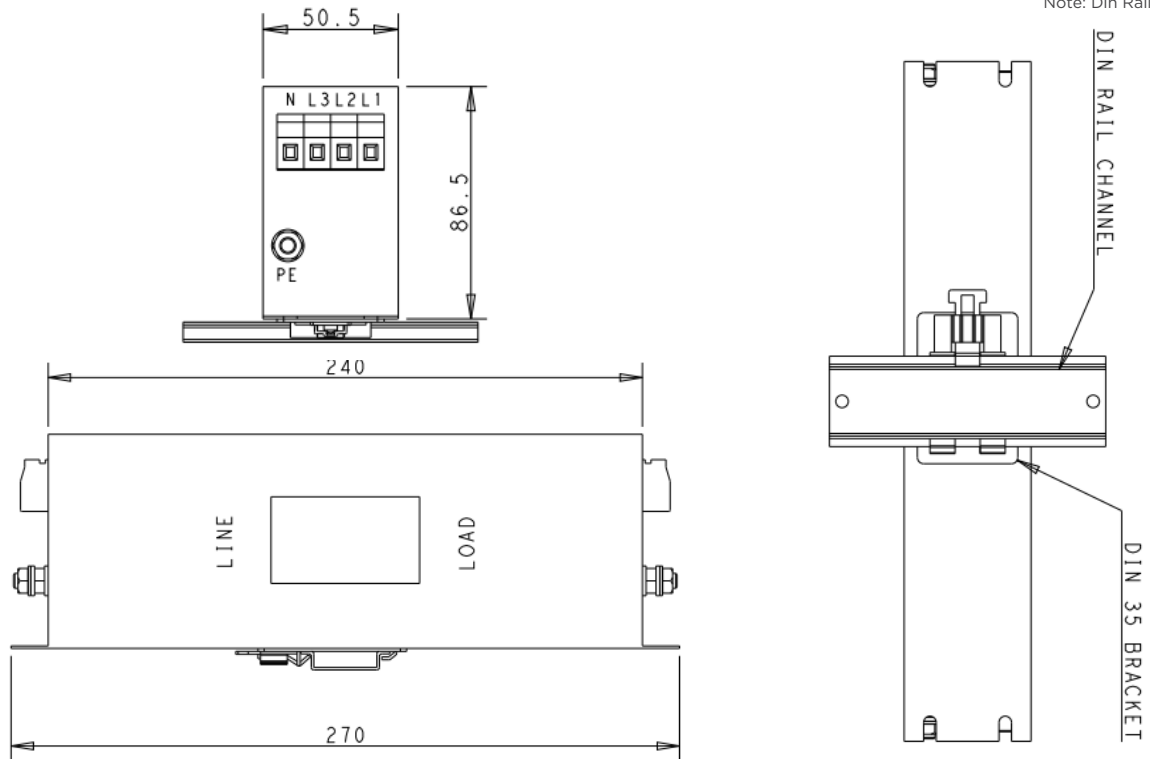

### 30A Shock Proof Type - Vertical Mount

Note: Din Rail not supplied

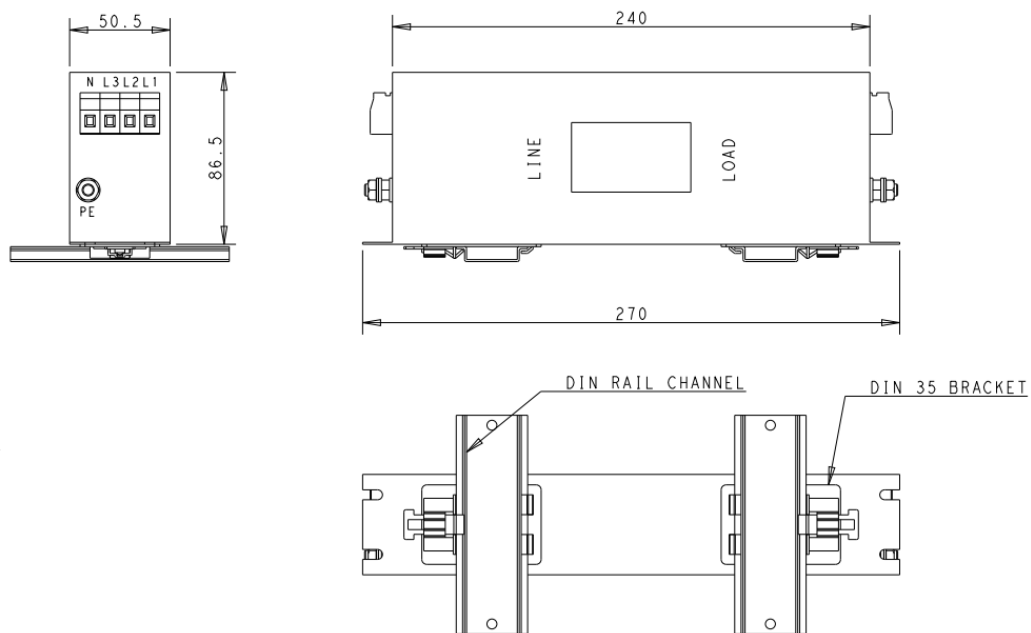

# KEP-BS Series

Three Phase High Performance EMI Filter

## Case Dimensions - Din Rail Mount

### 42A Shock Proof Type - Horizontal Mount

Note: Din Rail not supplied

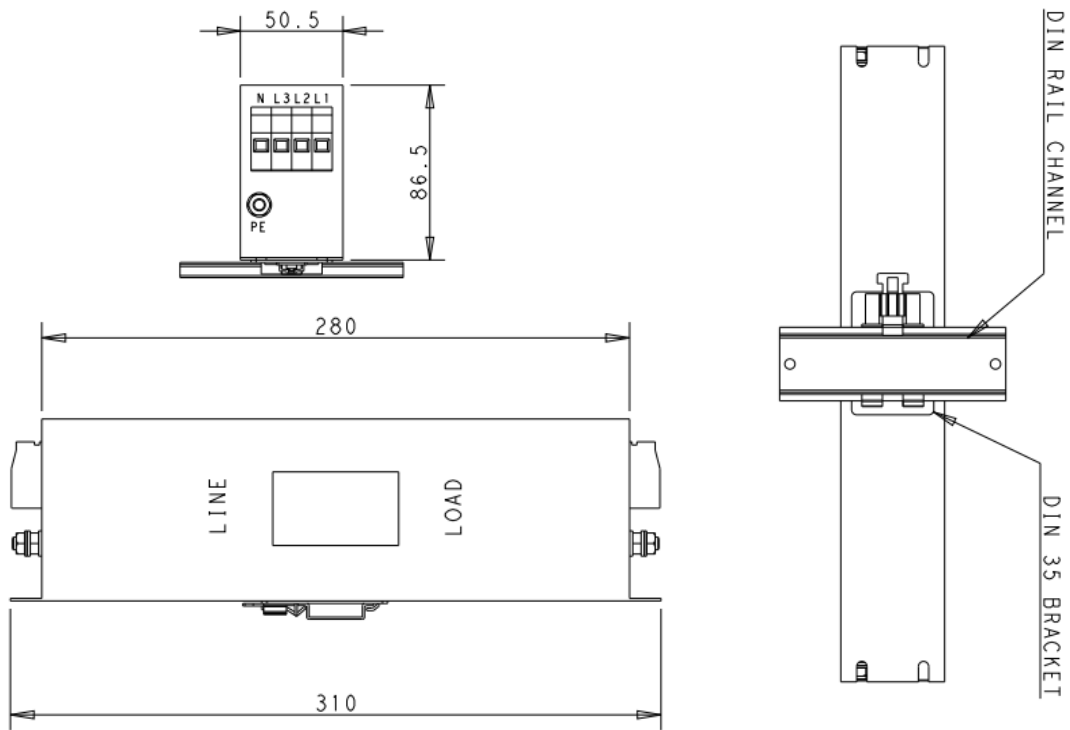

### 42A Shock Proof Type - Vertical Mount

Note: Din Rail not supplied

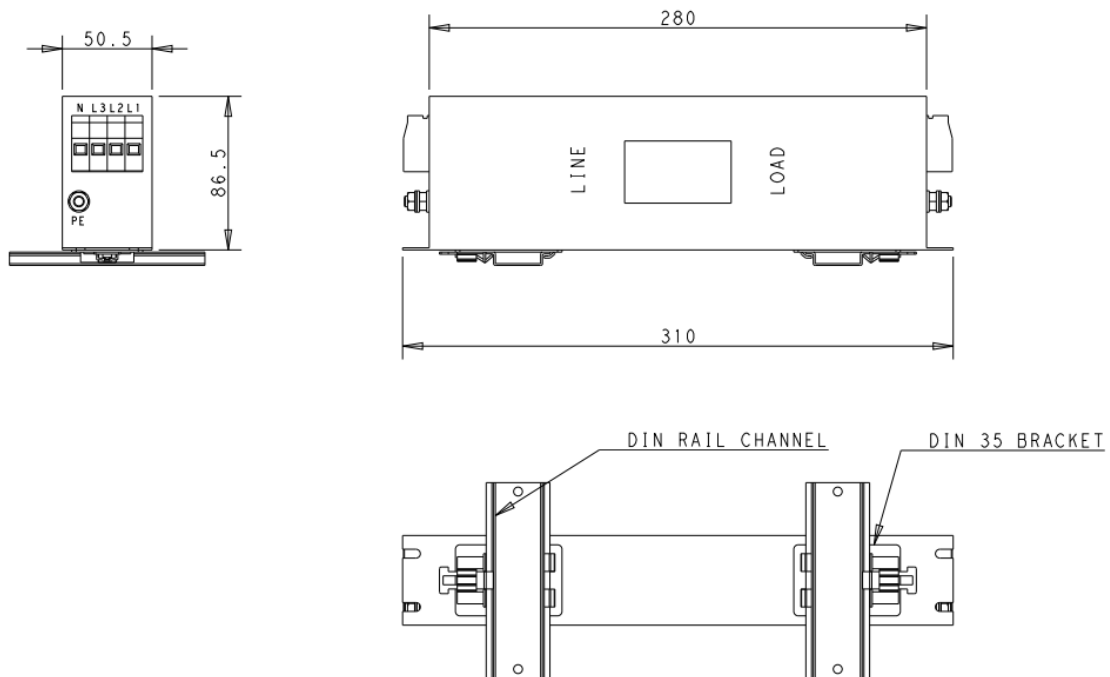

# KEP-BS Series

Three Phase High Performance EMI Filter

## Case Dimensions - Din Rail Mount

### 55A Shock Proof Type - Horizontal Mount

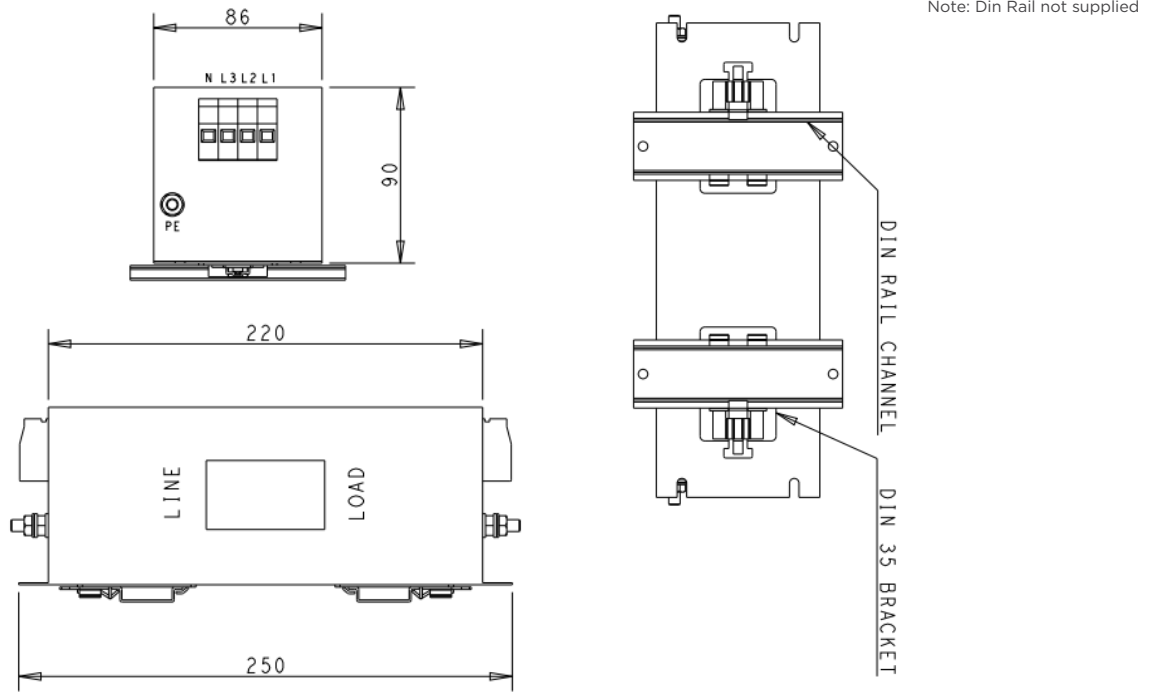

### 75A Shock Proof Type - Horizontal Mount

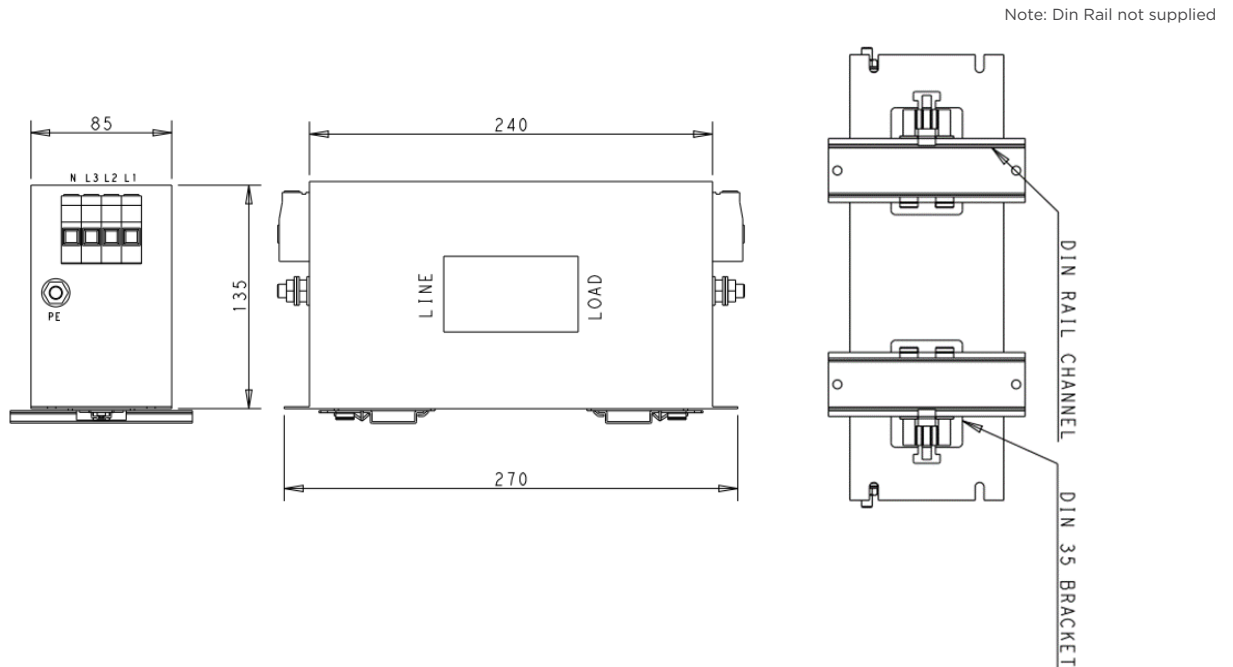

All dimensions in mm; Tolerances according: ISO2768-m

# KEP-BS Series

Three Phase High Performance EMI Filter

## Case Dimensions - Din Rail Mount

### 100A Shock Proof Type - Horizontal Mount

Note: Din Rail not supplied

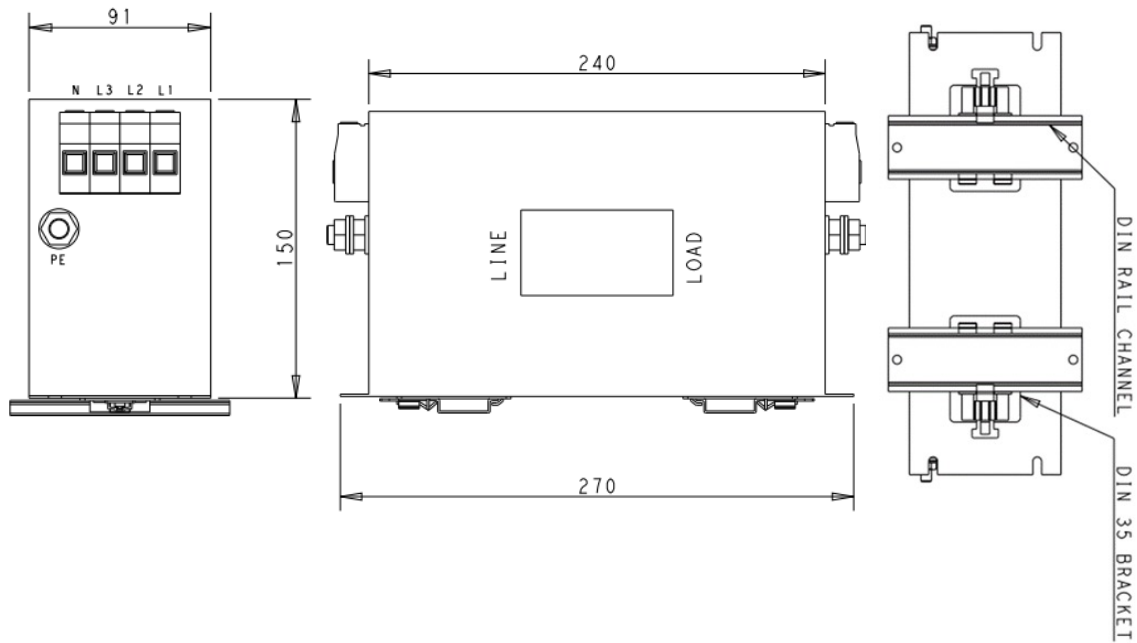

All dimensions in mm; Tolerances according: ISO2768-m

## HOW TO ORDER

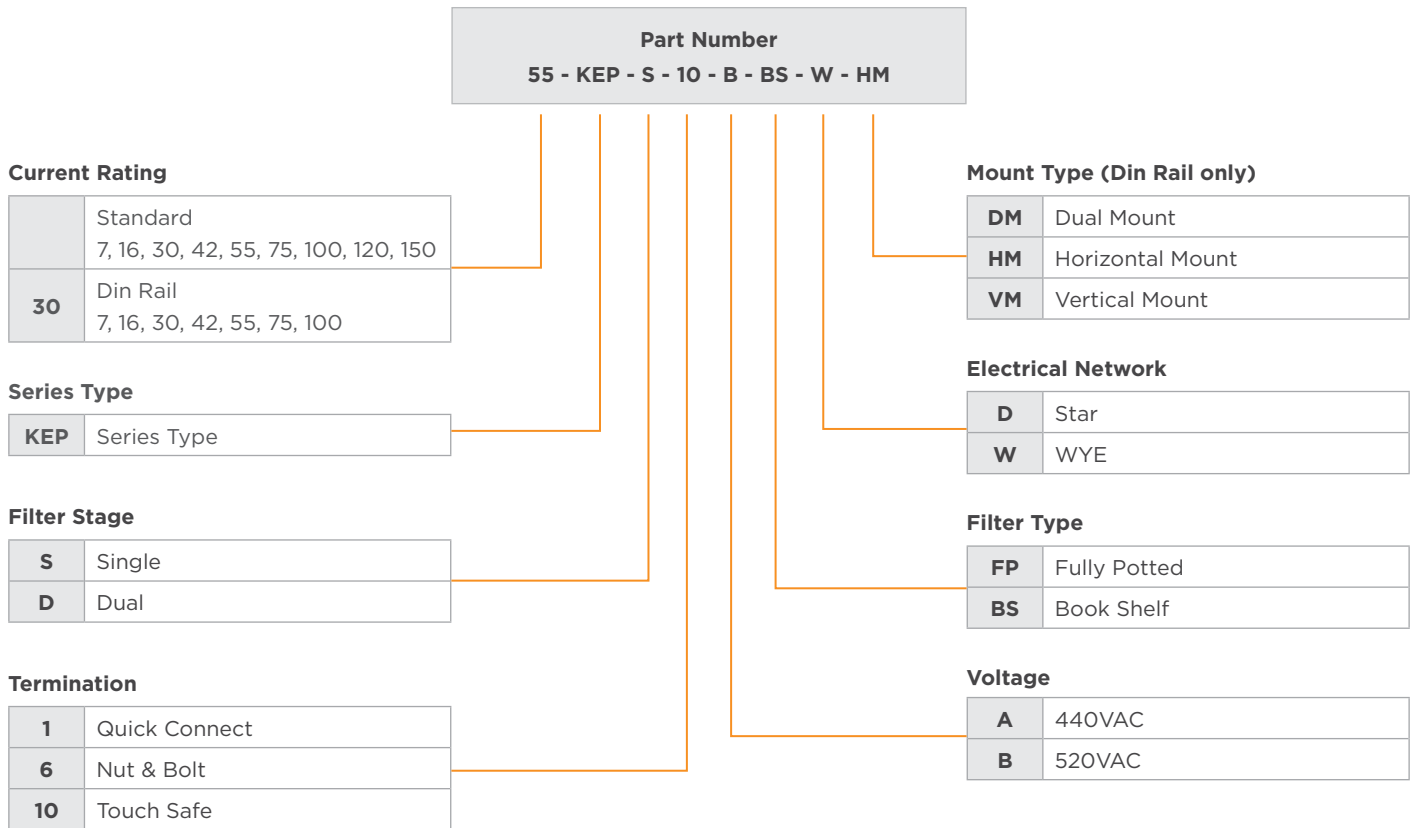

## te.com

©2022 TE Connectivity. All Rights Reserved.

TE Connectivity, TE Connectivity (logo) and Every Connection Counts are trademarks. All other logos, products and/or company names referred to herein might be trademarks of their respective owners.

The information given herein, including drawings, illustrations and schematics which are intended for illustration purposes only, is believed to be reliable. However, TE Connectivity makes no warranties as to its accuracy or completeness and disclaims any liability in connection with its use. TE Connectivity's obligations shall only be as set forth in TE Connectivity's Standard Terms and Conditions of Sale for this product and in no case will TE Connectivity be liable for any incidental, indirect or consequential damages arising out of the sale, resale, use or misuse of the product. Users of TE Connectivity products should make their own evaluation to determine the suitability of each such product for the specific application.

12/22 ED