

NJM11100

■ ABSOLUTE MAXIMUM RATINGS

(Ta=25°C)

PARAMETER	SYMBOL	MAXIMUM RATING	UNIT
Input Voltage	V _{IN}	-0.3 to +20	V
Output Voltage	V _{OUT}	-0.3 to +19	V
Control Pin Voltage	V _{CONT}	-0.3 to +20	V
Output Adjust Pin Voltage	V _{ADJ}	-0.3 to +4	V
Noise Bypass Pin Voltage (*5)	V _{NB}	-0.3 to +4	V
Power Dissipation	P _D	SOT-23-6	510(*1) 710(*2)
		DFN6-H1 (ESON6-H1)	450(*3) 1200(*4)
Operating Temperature Range	Topr	-40 to +85	°C
Storage Temperature Range	Tstg	-40 to +150	°C

(*1): Mounted on glass epoxy board. (76.2×114.3×1.6mm: based on EIA/JDEC standard, 2Layers)

(*2): Mounted on glass epoxy board. (76.2×114.3×1.6mm: based on EIA/JDEC standard, 4Layers), internal Cu area: 74.2×74.2mm

(*3): Mounted on glass epoxy board (101.5×114.5×1.6mm: based on EIA/JDEC standard, 2Layers FR-4, with Exposed Pad)

(*4): Mounted on glass epoxy board (101.5×114.5×1.6mm: based on EIA/JDEC standard, 4Layers FR-4, with Exposed Pad)

(4Layers: Applying 99.5×99.5mm inner Cu area and a thermal via hole to a board based on JEDEC standard JESD51-5)

(*5): When input voltage is less than +4V, the absolute maximum control voltage is equal to the input voltage.

■ RECOMMENDED OPERATING CONDITIONS

PARAMETER	SYMBOL	TEST CONDITION	MIN.	TYP.	MAX.	UNIT
Input Voltage Range	V _{IN}		2.1	-	18	V
Output Voltage Range	V _{OUT}		1.3	-	17	V

■ ELECTRICAL CHARACTERISTICS

(Unless other noted, V_{IN}=4V, R1=51kΩ, R2=68kΩ, C_{IN}=0.1μF, C_O=1.0μF (V_O<1.4V: 2.2μF), C_p=0.01μF, C_{fb}=100pF, Ta=25°C)

PARAMETER	SYMBOL	TEST CONDITION	MIN.	TYP.	MAX.	UNIT
Reference Voltage	V _{ref}	I _O =30mA	-1.0%	1.25	+1.0%	V
Quiescent Current	I _Q	I _O =0mA, except I _{cont}	-	200	260	μA
Quiescent Current at OFF-state	I _{Q(OFF)}	V _{CONT} =0V	-	-	100	nA
Ground Current	I _{GND}	I _O =50mA	-	0.75	1.5	mA
Output Current	I _O	V _O =0.3V	240	320	-	mA
Line Regulation	ΔV _O /ΔV _{IN}	V _{IN} =V _O +1V to V _O +6V, I _O =30mA	-	-	0.10	%/V
Load Regulation	ΔV _O /ΔI _O	I _O =0 to 200mA	-	-	0.01	%/mA
Dropout Voltage(*6)	ΔV _{LO}	I _O =200mA	-	0.2	0.35	V
Control Voltage at ON-state	V _{CONT(ON)}		1.6	-	-	V
Control Voltage at OFF-state	V _{CONT(OFF)}		-	-	0.6	V
Control Current	I _{CONT}	V _{CONT} =1.6V	-	3	12	μA
Ripple Rejection	RR	e _{in} =200mVrms, f=1kHz, I _O =10mA, V _O =3V setting	-	75	-	dB
Average Temperature Coefficient of Output Voltage	ΔV _O /ΔTa	Ta=0°C to +85°C, I _O =30mA	-	±35	-	ppm/°C
Output Noise Voltage	V _{NO}	f=10Hz to 80kHz, I _O =10mA, V _O =3V setting	-	30	-	μVrms

(*6): Except setting Output Voltage less than 2.1V.

POWER DISSIPATION vs. AMBIENT TEMPERATURE

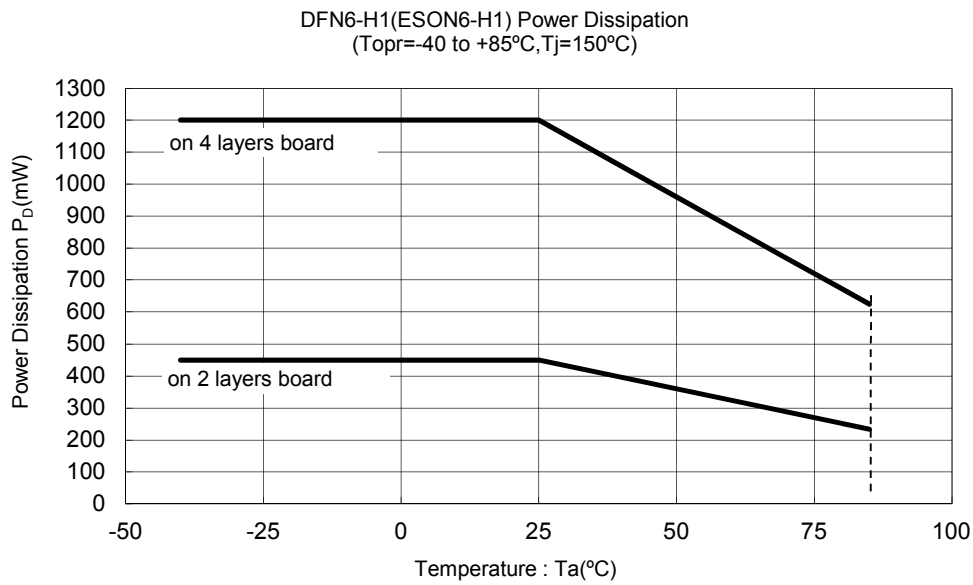
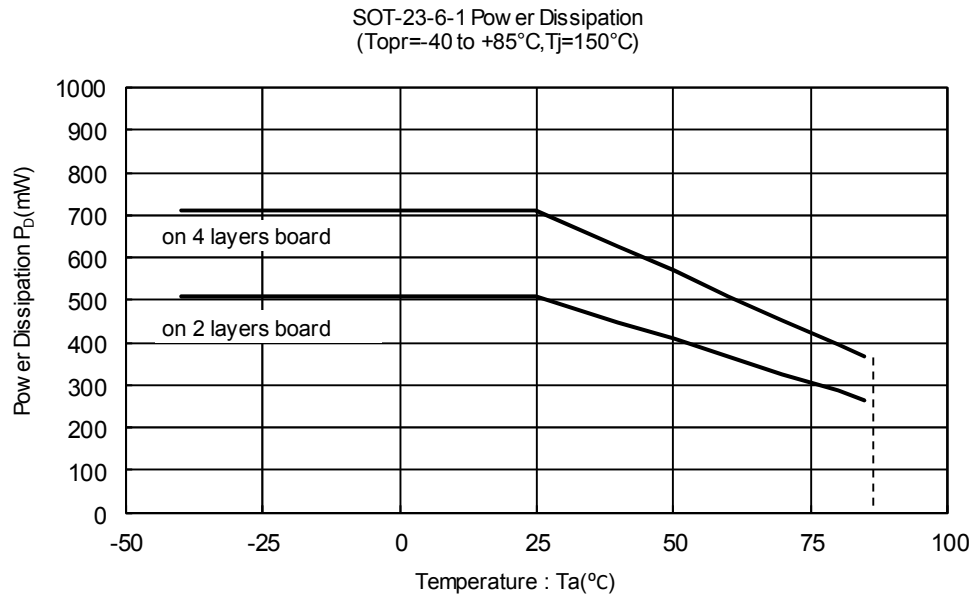

NJM11100

■ TEST CIRCUIT

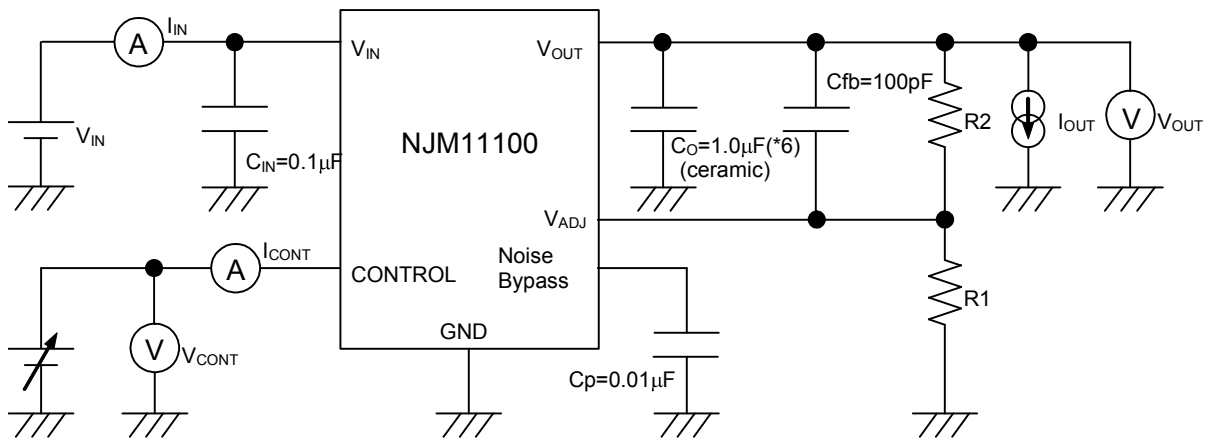

(*7): $V_o < 1.4\text{V}$: $2.2\mu\text{F}$

■ TYPICAL APPLICATION

1. In the case where ON/OFF Control is not required:

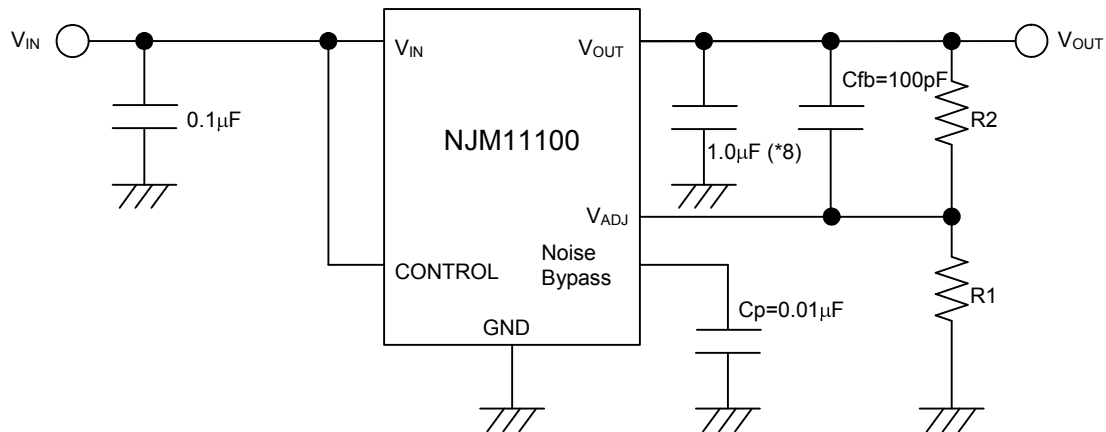

Connect CONTROL pin to V_{IN} pin
 (*8): $V_O < 1.4V$: $2.2\mu F$

2. In use of ON/OFF CONTROL:

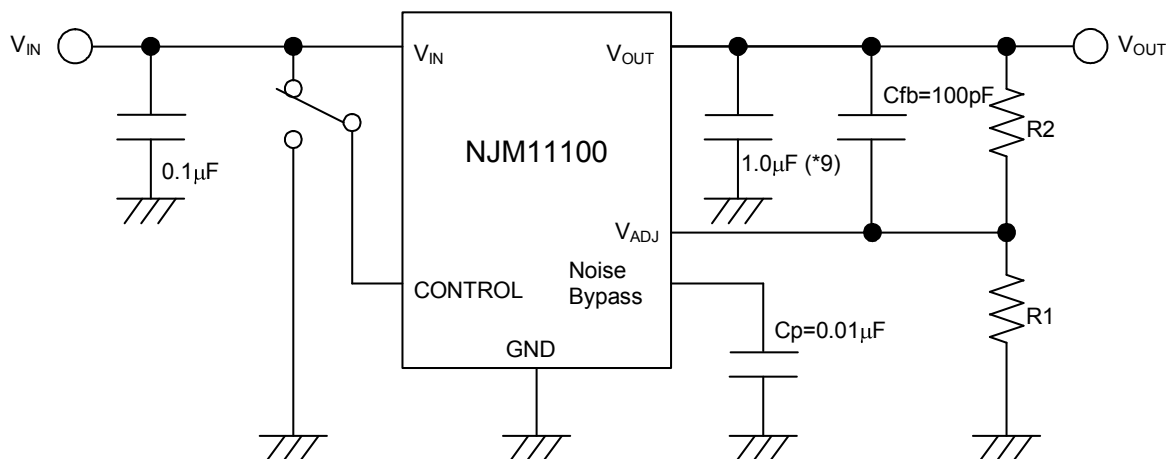

State of CONTROL pin:

- “H” → output is enabled.
- “L” or “open” → output is disabled.

(*9): $V_O < 1.4V$: $2.2\mu F$

[Output voltage setting formula]

$$V_{OUT} = V_{ref} \times \frac{R1 + R2}{R1}$$

$$V_{ref(typ)} = 1.25V$$

$$1.3V \leq V_{OUT(typ)} \leq 17.0V$$

R1 value should be selected between $1k\Omega$ and $120k\Omega$.

* Input Capacitor C_{IN}

Input Capacitor C_{IN} is required to prevent oscillation and reduce power supply ripple for applications when high power supply impedance or a long power supply line.

Therefore, use the recommended C_{IN} value (refer to conditions of ELECTRIC CHARACTERISTIC) or larger and should connect between GND and V_{IN} as shortest path as possible to avoid the problem.

* Output Capacitor C_O (MLCC)

Output capacitor (C_O) will be required for a phase compensation of the internal error amplifier.

The capacitance and the equivalent series resistance (ESR) influence to stable operation of the regulator.

Use of a smaller C_O may cause excess output noise or oscillation of the regulator due to lack of the phase compensation.

On the other hand, Use of a larger C_O reduces output noise and ripple output, and also improves output transient response when rapid load change.

Therefore, use the recommended C_O value (refer to conditions of ELECTRIC CHARACTERISTIC) or larger and should connect between GND and V_{OUT} as shortest path as possible for stable operation

The recommended capacitance depends on the output voltage rank. Especially, low voltage regulator requires larger C_O value.

In addition, you should consider varied characteristics of capacitor (a frequency characteristic, a temperature characteristic, a DC bias characteristic and so on) and unevenness peculiar to a capacitor supplier enough.

When selecting C_O , recommend that have withstand voltage margin against output voltage and superior temperature characteristic though this product is designed stability works with wide range ESR of capacitor including low ESR products.

* Noise bypass Capacitor C_p

Noise bypass capacitor C_p reduces noise generated by band-gap reference circuit. Noise level and ripple rejection will be improved when larger C_p is used. Use of smaller C_p value may cause oscillation.

Use the C_p recommended value larger (refer to conditions of ELECTRIC CHARACTERISTIC) to avoid the problem.

* Reverse Current Protection

NJM11100 is built in Reverse Current Protection circuit.

So external Schottky barrier diode(SBD) is not required that this circuit prevents the large reverse current due to the output voltage being higher than the input voltage.

CHARACTERISTICS

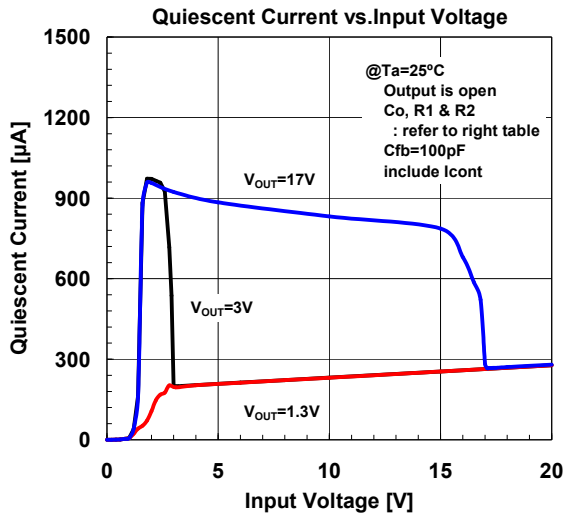

$V_{OUT}=1.3V$: $C_O=2.2\mu F$, $R1=51k\Omega$, $R2=2k\Omega$
 $3.0V$: $C_O=1.0\mu F$, $R1=51k\Omega$, $R2=68k\Omega$
 $17V$: $C_O=1.0\mu F$, $R1=51k\Omega$, $R2=640k\Omega$

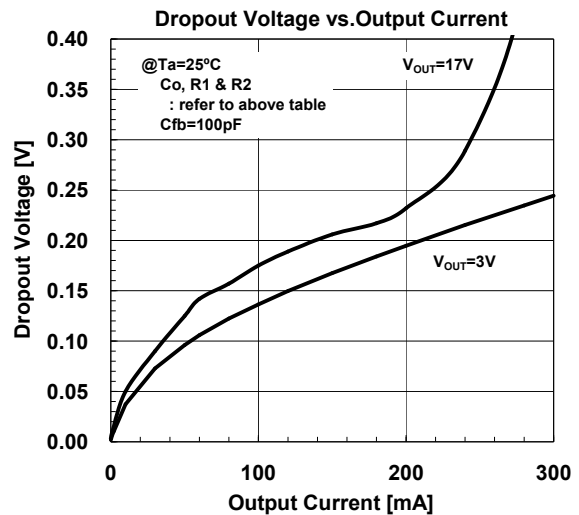
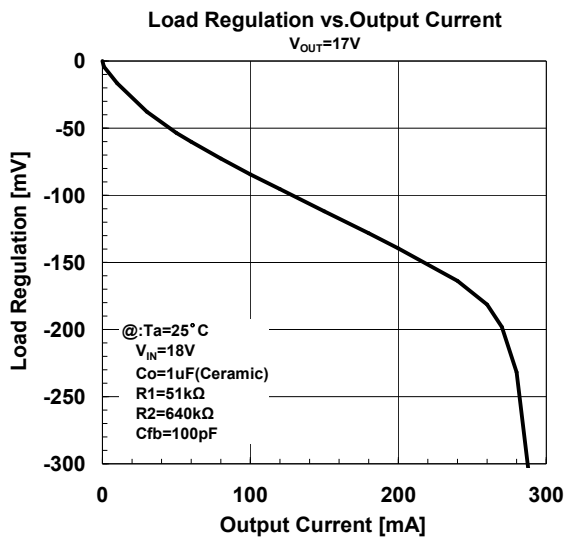
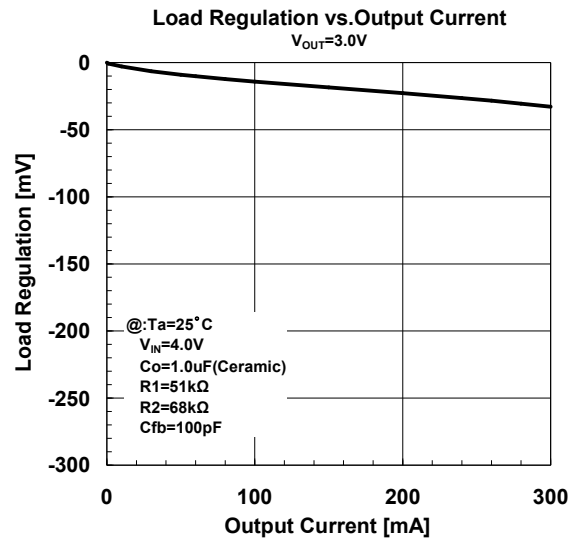
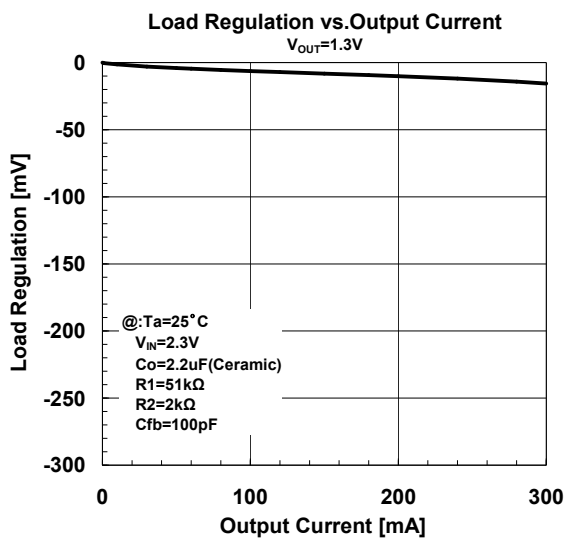

CHARACTERISTICS

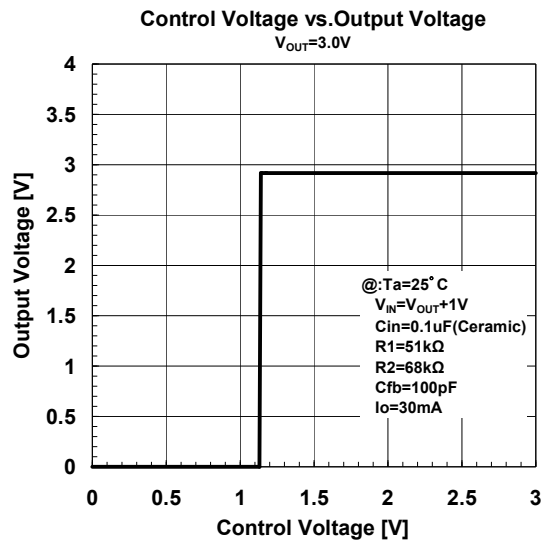
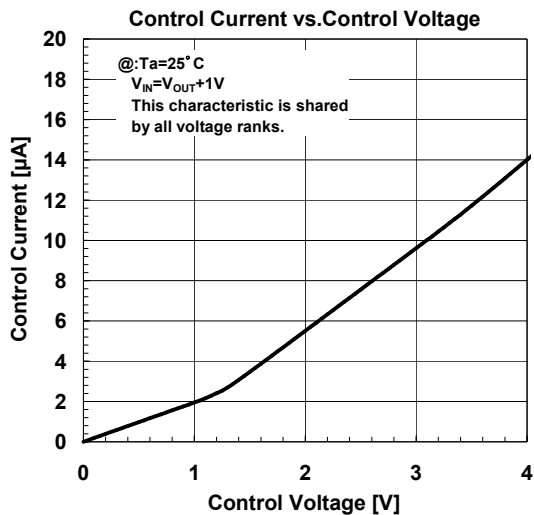
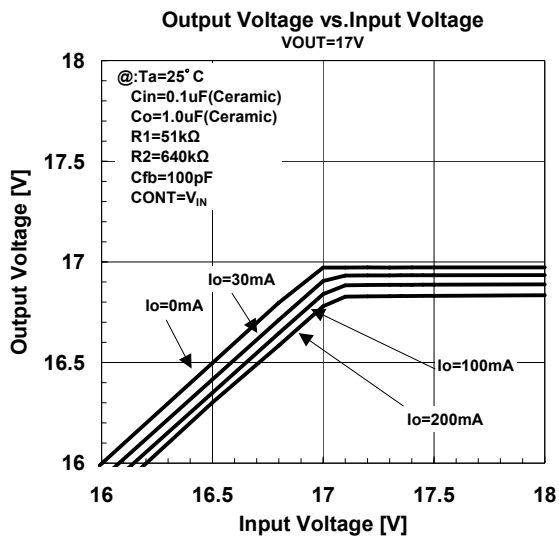
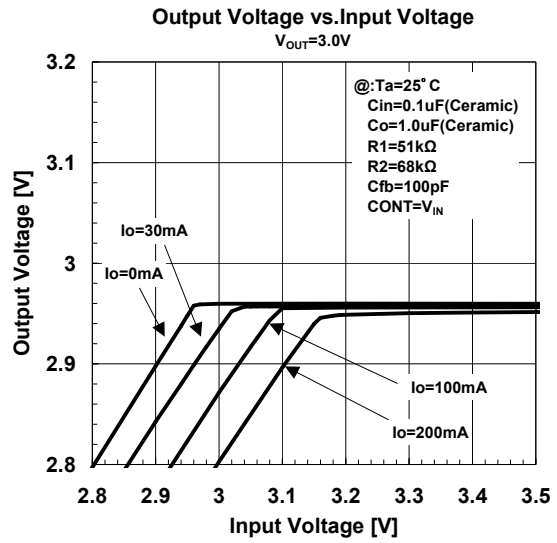
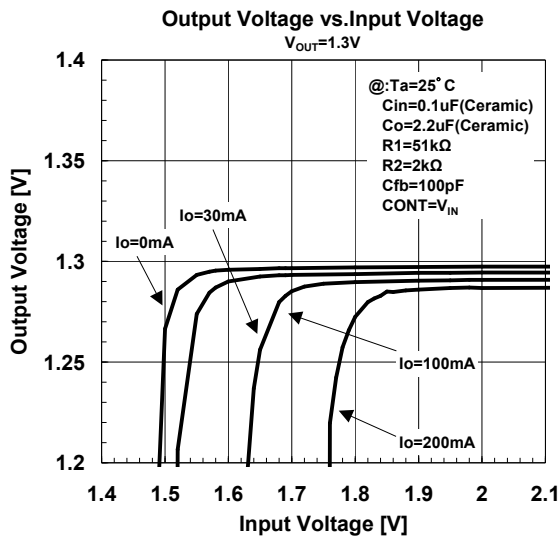

CHARACTERISTICS

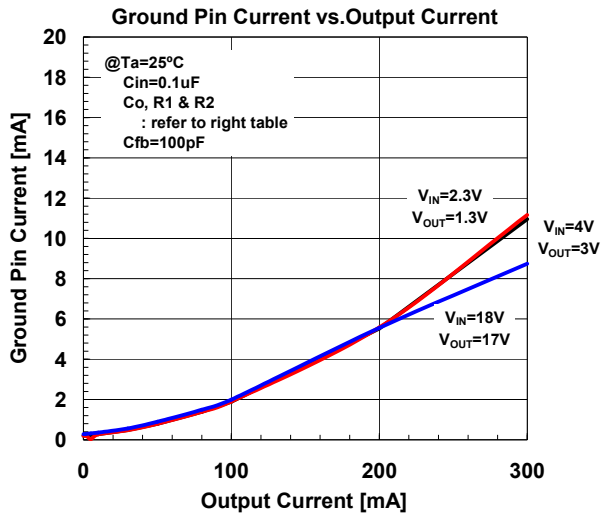

V_{OUT}=1.3V: C_O=2.2μF, R₁=51kΩ, R₂=2kΩ
 3.0V: C_O=1.0μF, R₁=51kΩ, R₂=68kΩ
 17V: C_O=1.0μF, R₁=51kΩ, R₂=640kΩ

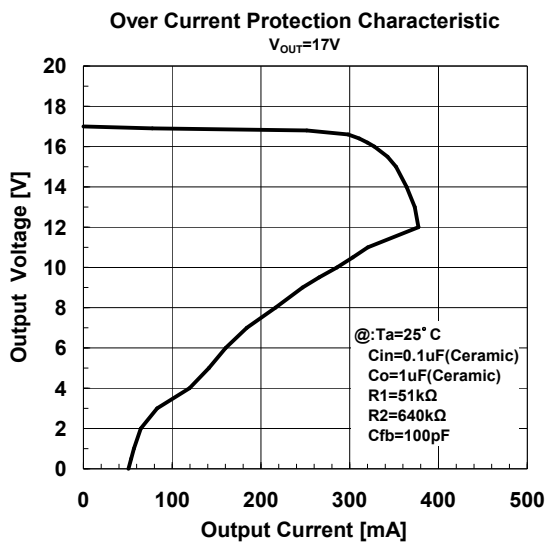
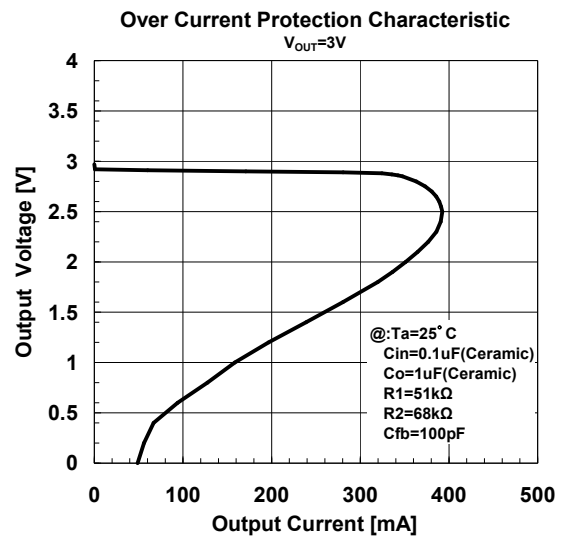
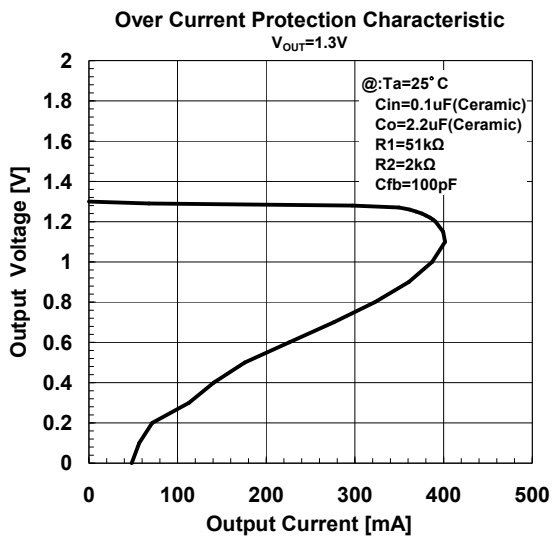

CHARACTERISTICS

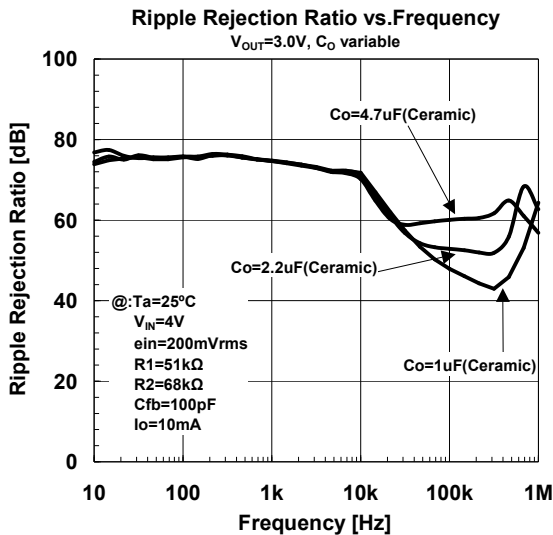
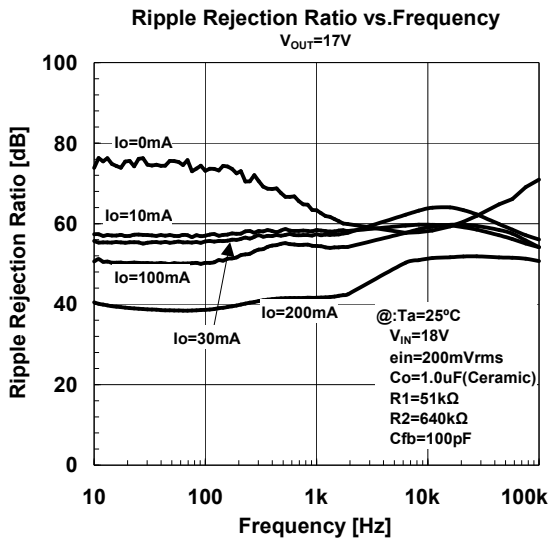
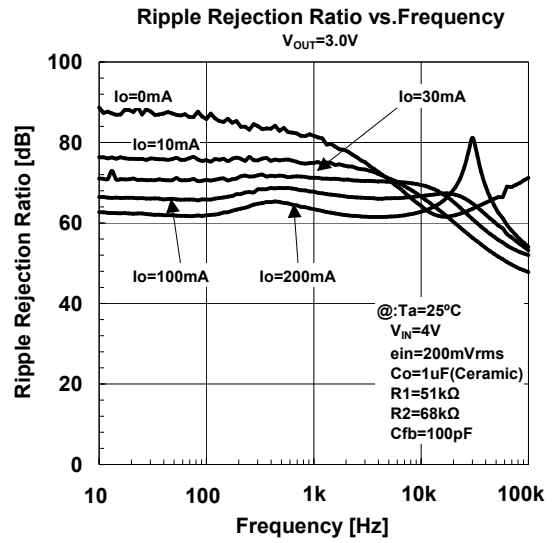
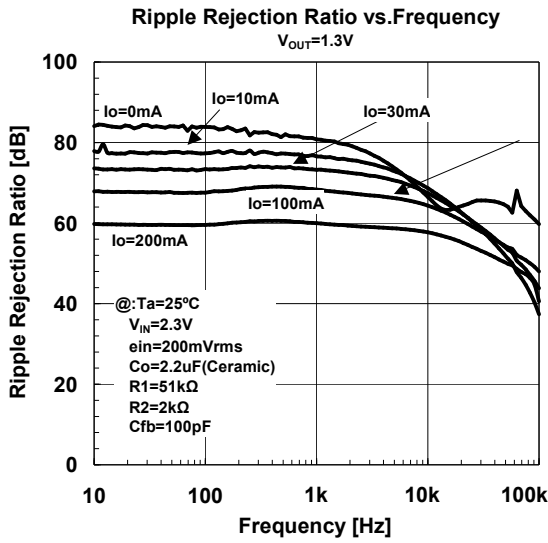

CHARACTERISTICS

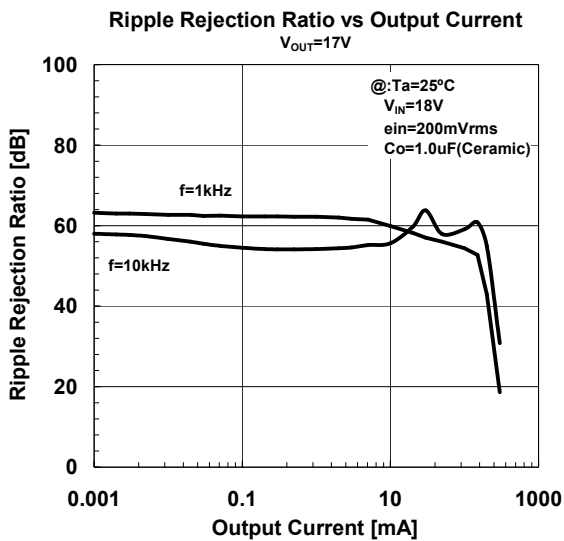
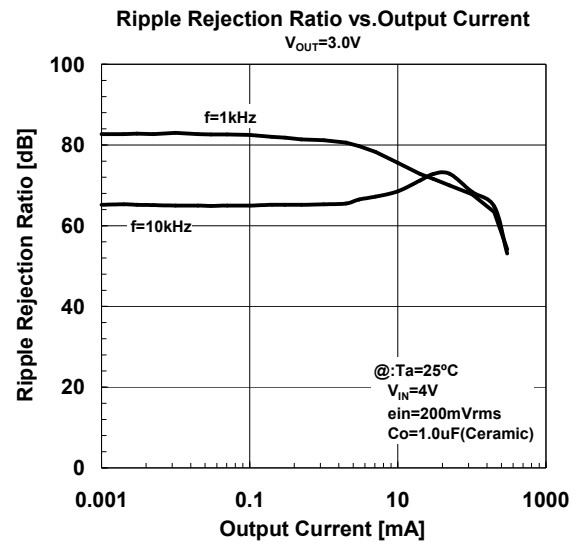
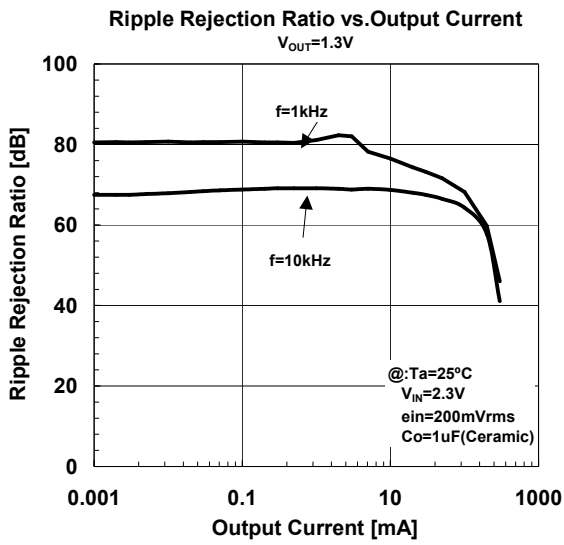

NJM11100

CHARACTERISTICS

Output Noise Voltage vs. Output Current

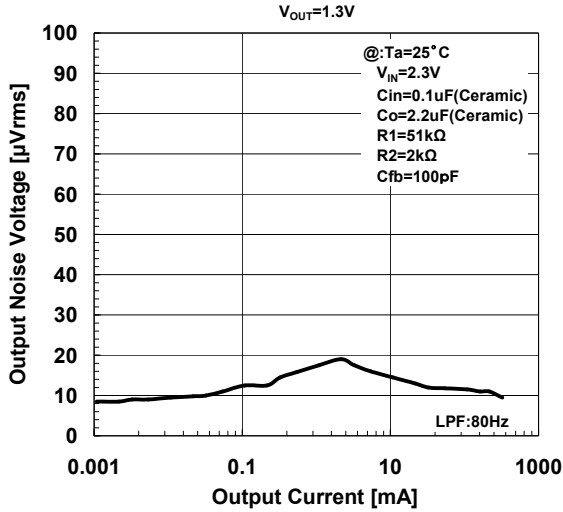

Output Noise Voltage vs. Output Current

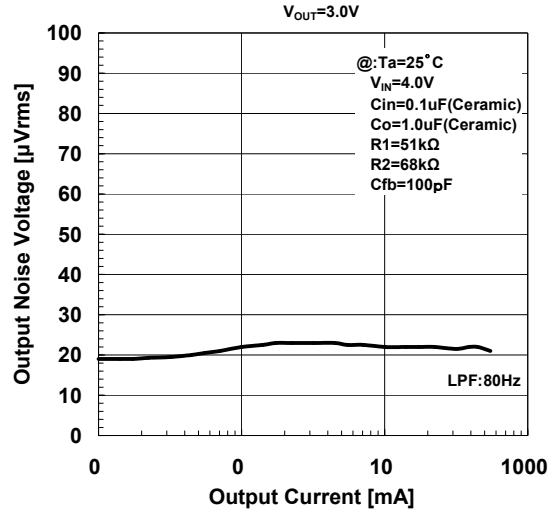

Output Noise Voltage vs. Output Current

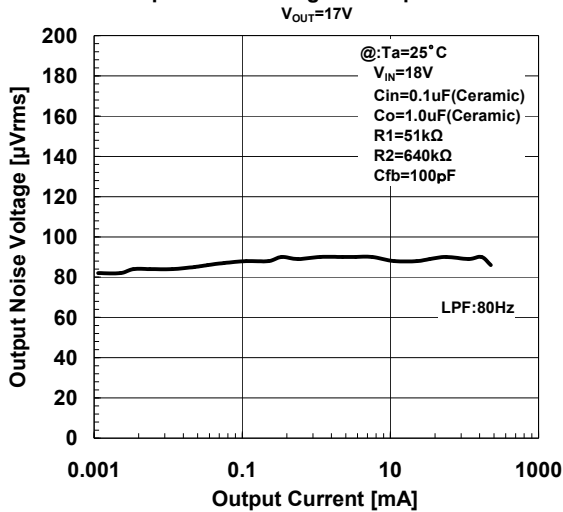

Output Noise Voltage vs. Noise Bypass Capacitance

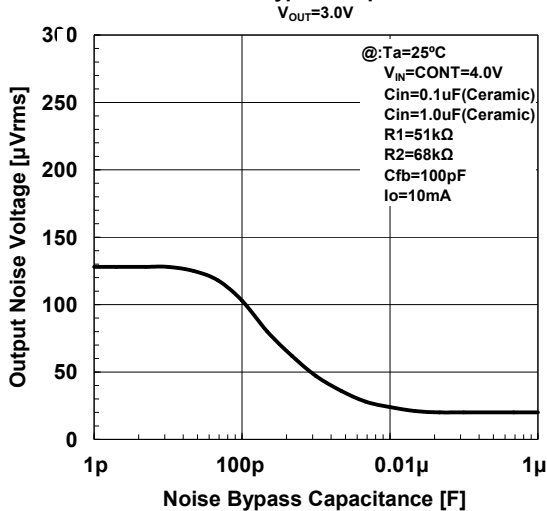

CHARACTERISTICS

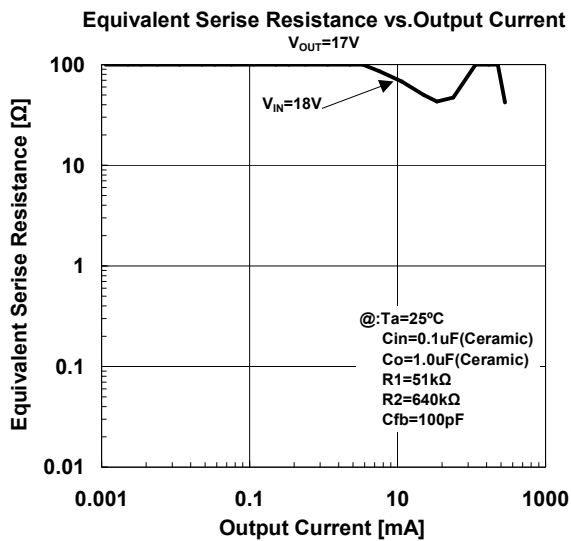
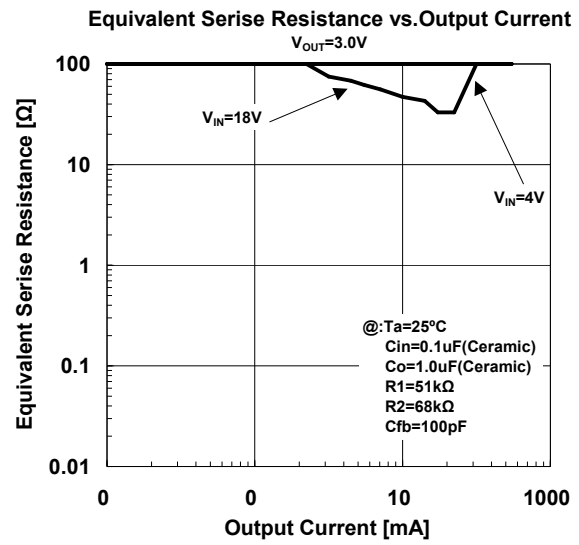
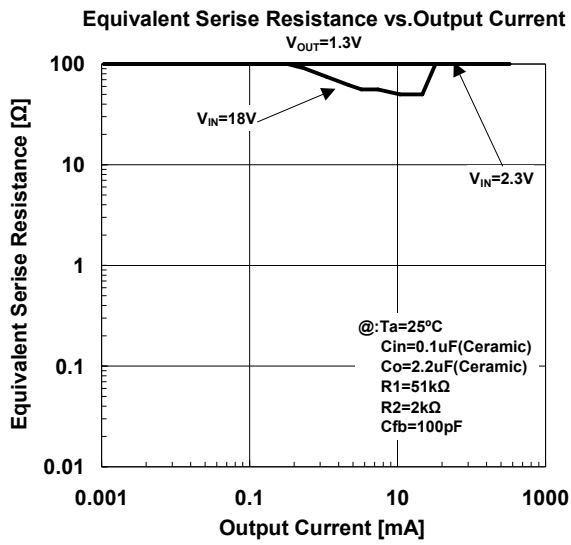

CHARACTERISTICS

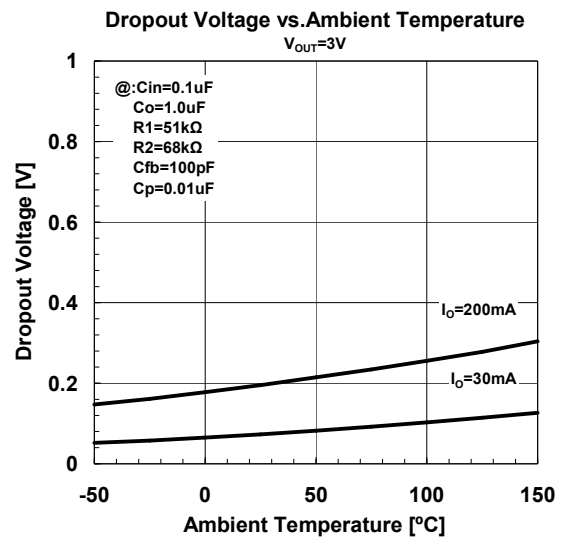
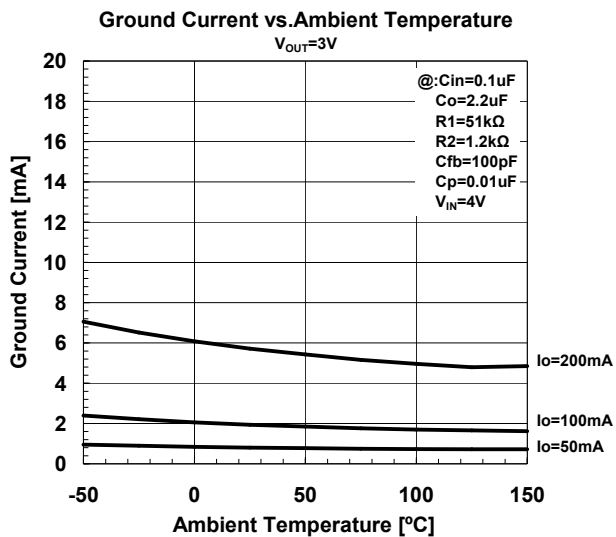
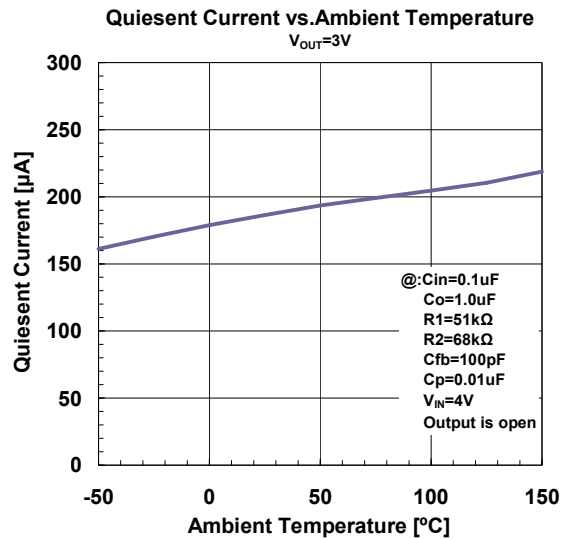
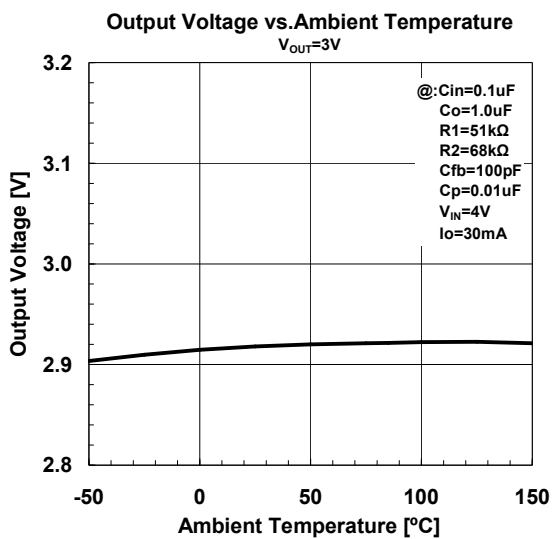
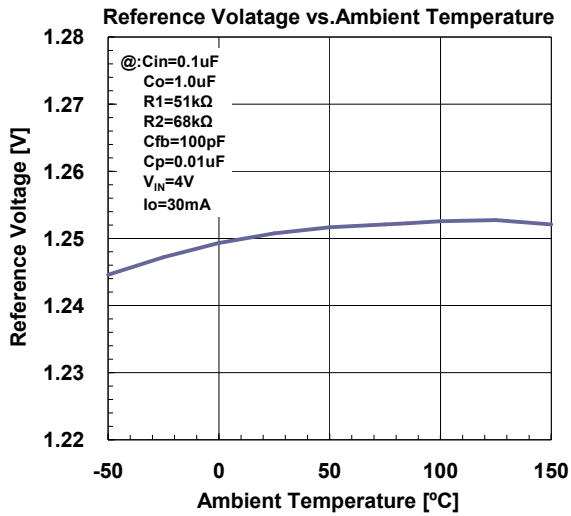

CHARACTERISTICS

Control Current vs. Ambient Temperature

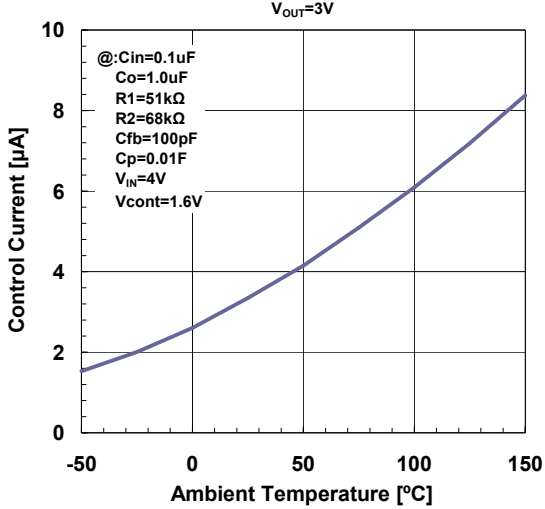

Control Voltage vs. Temperature

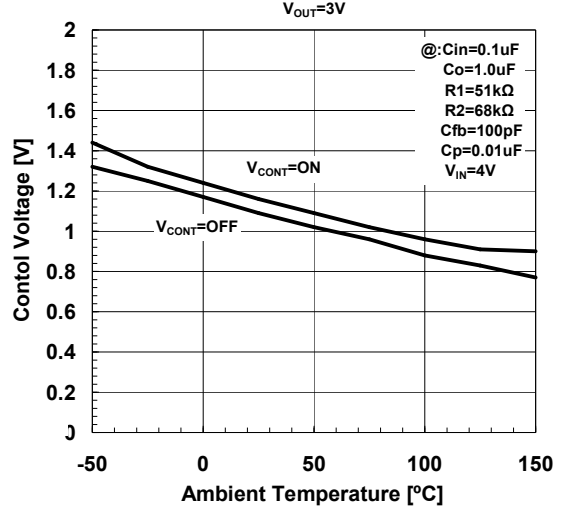

Line Regulation vs. Ambient Temperature

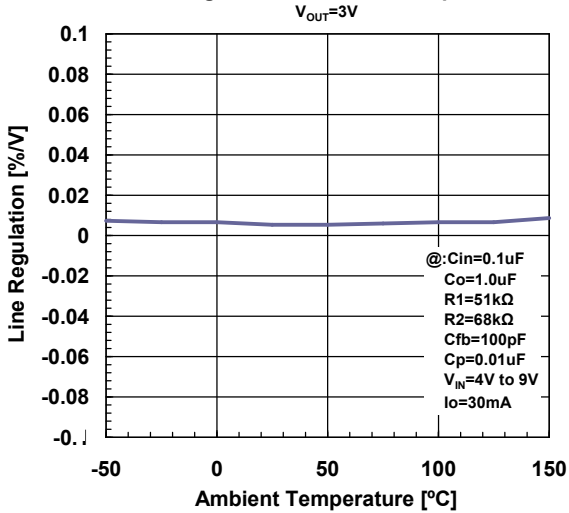

Load Regulation vs. Ambient Temperature

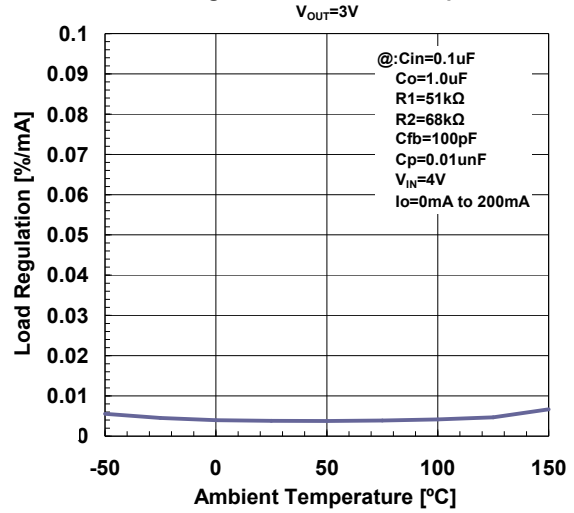

Output Peak Current vs. Ambient Temperature

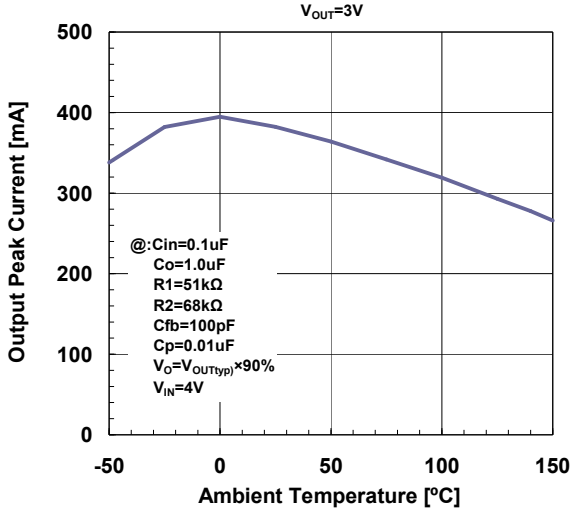

Thermal Shutdown Characteristic

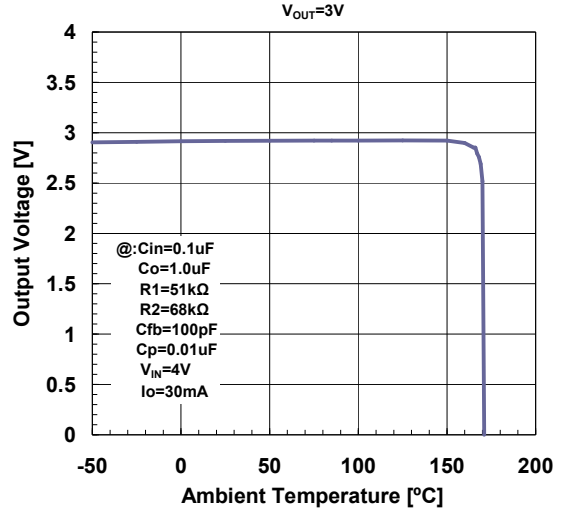

CHARACTERISTICS

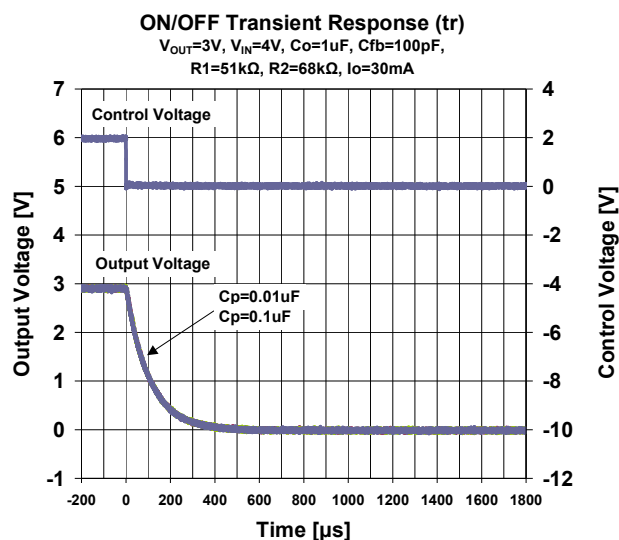
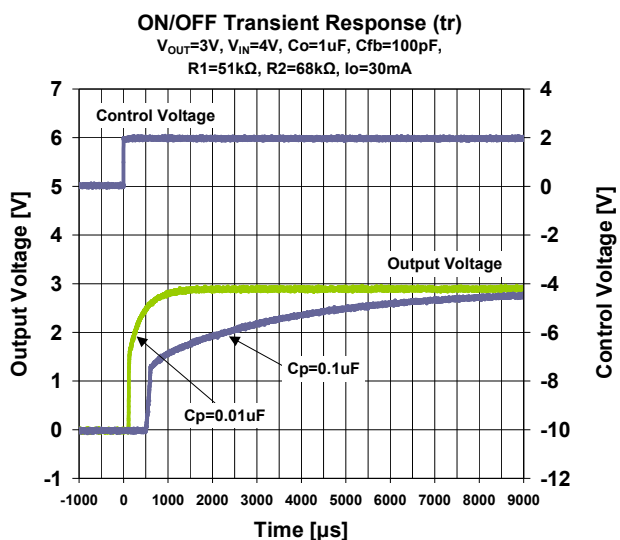
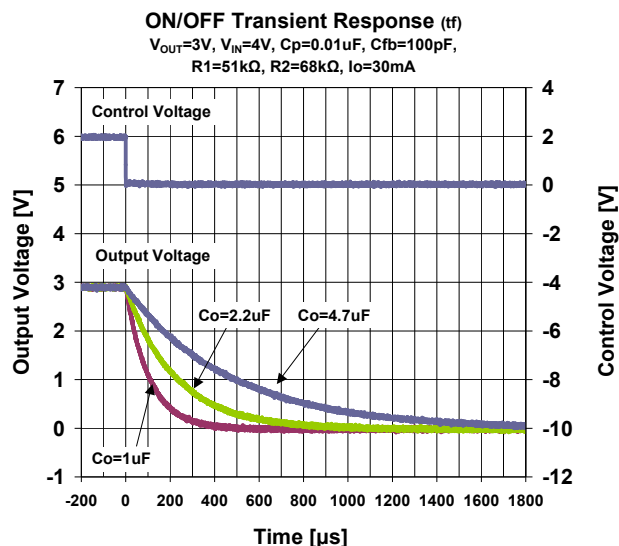
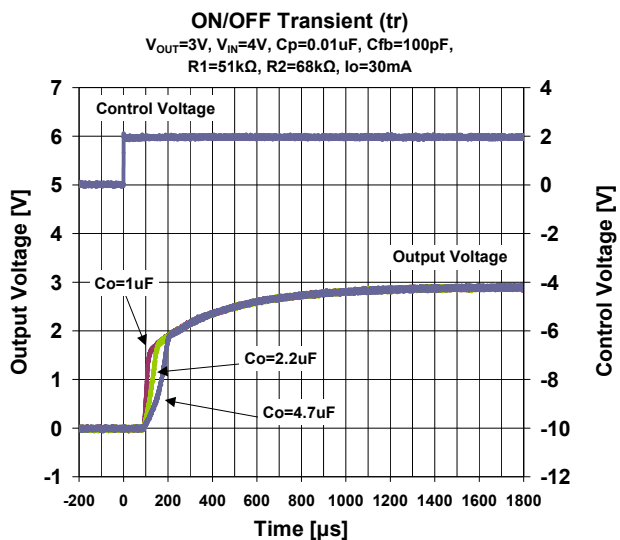
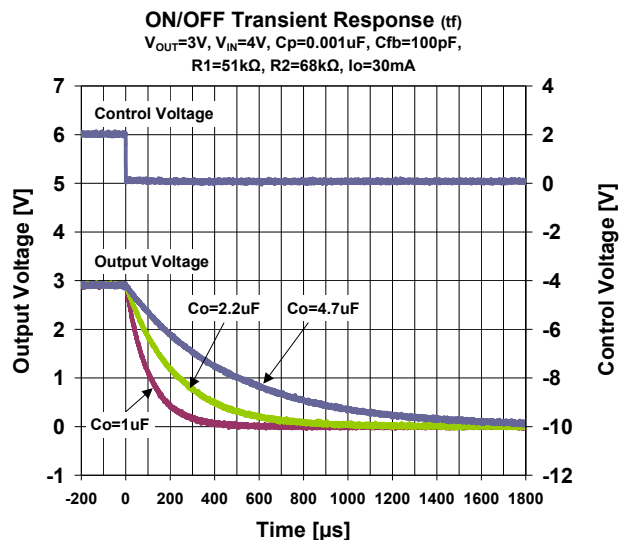
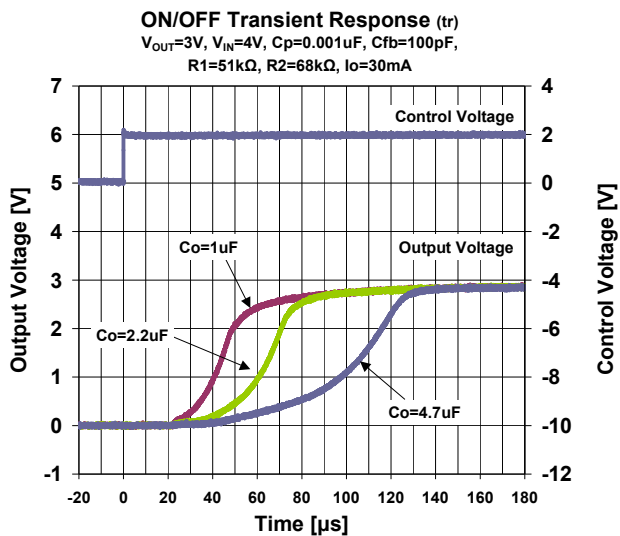

■ CHARACTERISTICS

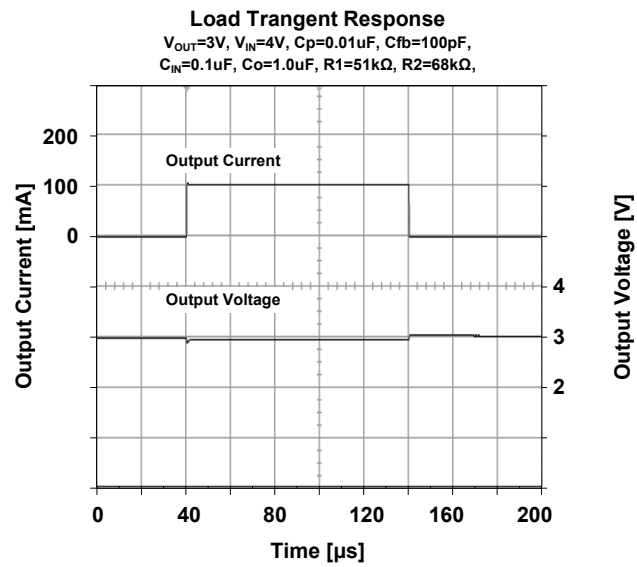
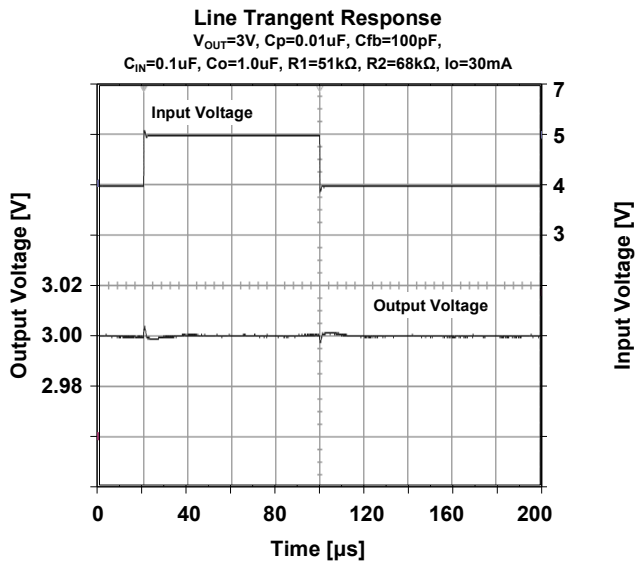

NJM11100

■ PACKAGE OUT LINE

SOT-23-6-1

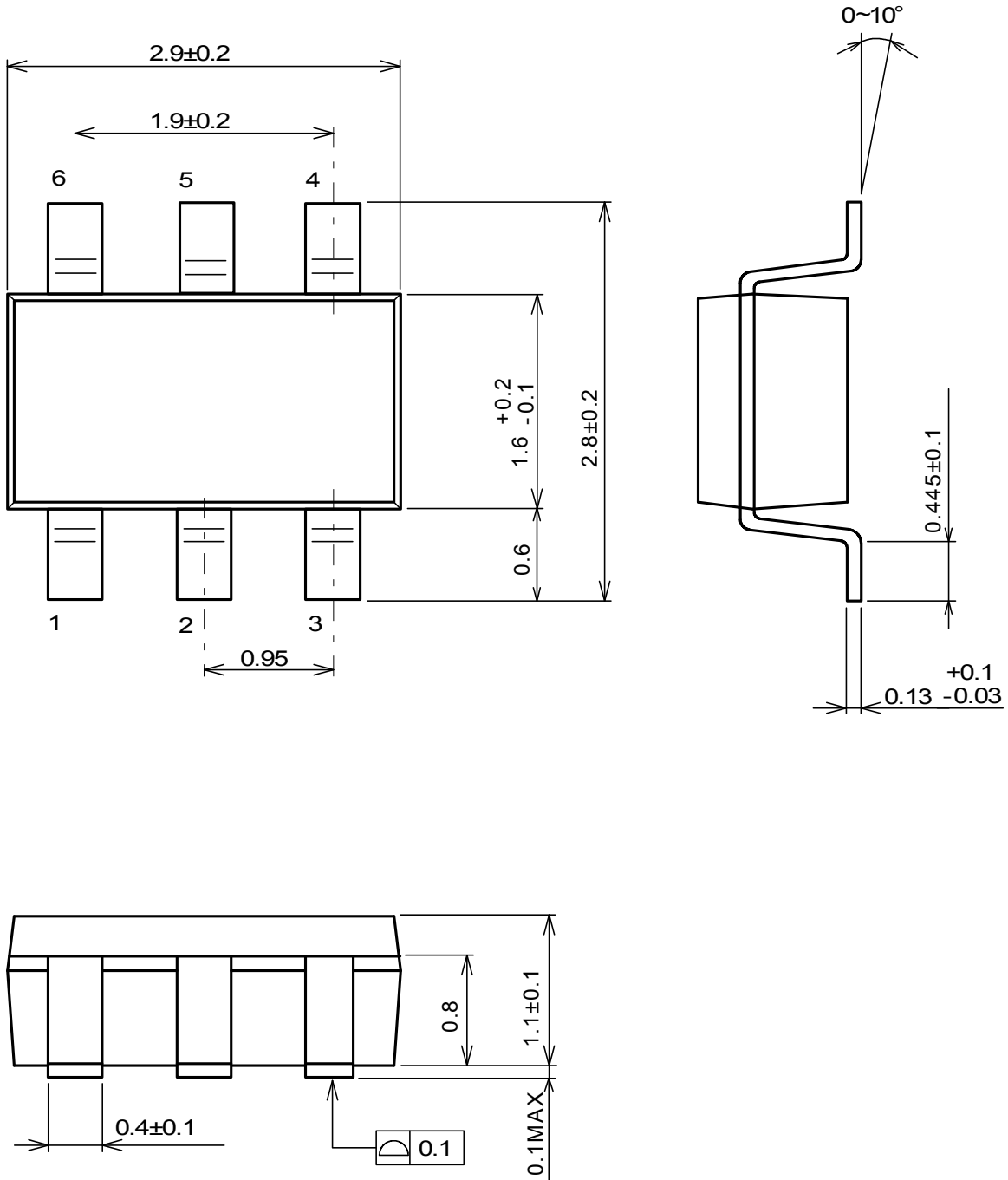

NOTES

All linear dimensions are in millimeters.

UNIT : mm

[CAUTION]

The specifications on this datasheets are only given for information , without any guarantee as regards either mistakes or omissions.

The application circuits in this datasheets are described only to show representative usages of the product and not intended for the guarantee or permission of any right including the industrial rights.