

Revision Level			Revision Record	Changed	Date	Approved	Date
Drawing	State	Part					
01.2	DESIGN RELEASE		SEE ECN# 014408	FDS	04/23/18	EJH	04/23/18

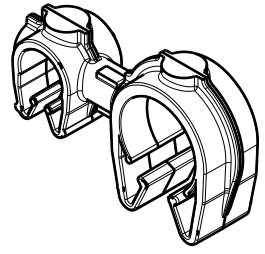

ISOMETRIC VIEW

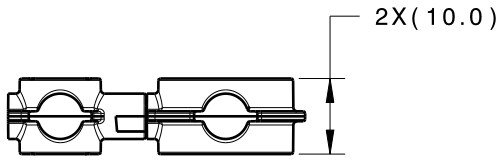
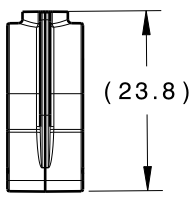
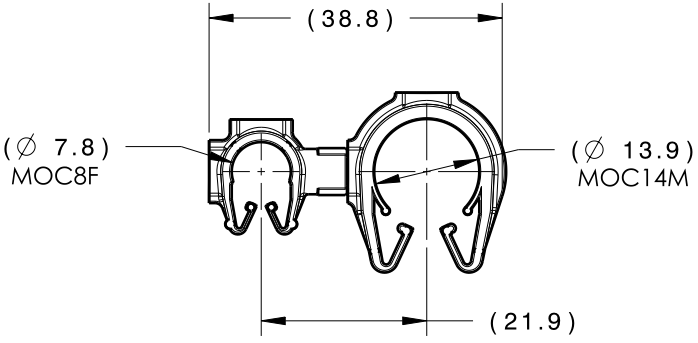

CLIPS ROTATE 360 DEGREES

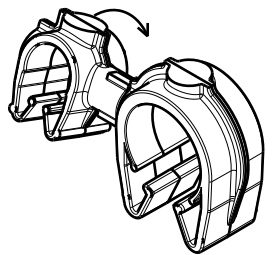

ISOMETRIC VIEW ROTATED

TYPE	MOC8F	MOC14M
HARNESS	7.5MM-8.5MM	13.0MM-15.0MM
HOSE	7.0MM-8.5MM	13.0MM-15.0MM
HARD PIPE/TUBE	7.9MM-9.0MM	14.0MM-15.8MM

*RECOMMENDED SIZES MAY DIFFER DEPENDING ON THE APPLICATION, PRODUCT REQUIREMENTS AND MATERIALS USED

GLOBAL PART DESCRIPTION 	MOC8F			MOC14M		
	DRAWING	MATERIAL	COLOR	DRAWING	MATERIAL	COLOR
MOC8FMOC14M-PA66HIRHS-BK	16-0316-000-CSU	PA66HIRHS	BLACK	16-0320-000-CSU	PA66HIRHS	BLACK

Material SEE CHART COLOR: SEE CHART	Units millimeters	The copyright of this drawing is reserved by HellermannTyton. It is issued on condition that it is not reproduced, copied or disclosed to a third party, either wholly or in part, without the consent of HellermannTyton.	Drawn	TAT	2/21/17	Article/Type-No	MOC8FMOC14M	Scale	1:1
	Tolerance defined on each dimension		Approved	EJH	2/28/17	Title	 8MM MOC COUPLED TO A 14MM MOC	Project Number	16-0326
			HellermannTyton			North America Email: corp@htamericas.com Web: www.hellermann.tyton.com		Drawing-No	PRODUCTION : Phase
16-0326-245-CSU 						Sheet 1/1			