

Data sheet | Item number: 770-944

h-distribution connector; 4-pole; Cod. A; 1 input; 2 outputs; outputs on one side; 2 locking levers; black

www.wago.com/770-944

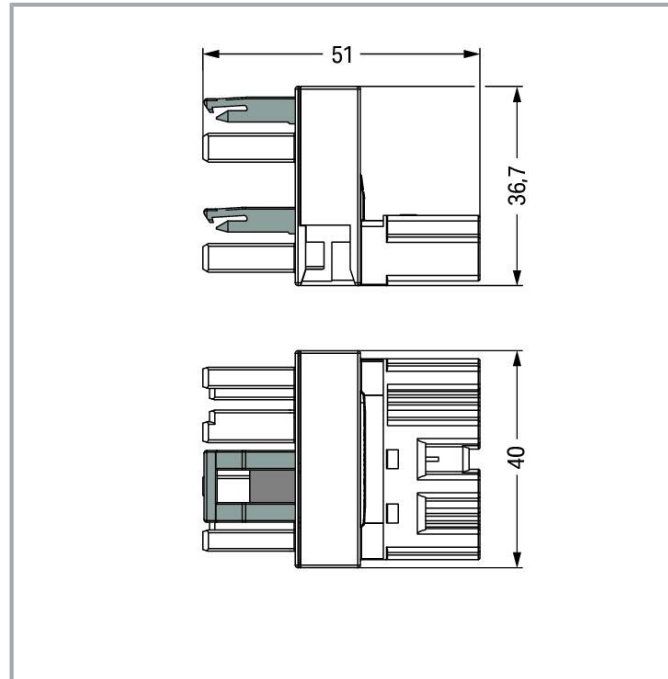

Item description

Distribution connector **WINSTA**® MIDI with protection against mismatching

The **WINSTA**® MIDI distribution connector rated current 25 A supports fast, reliable installation. The pluggable installation connectors with spring pressure connection technology work entirely without screw connections. They allow flexible, error-free installation in numerous possible uses. The coding options reduce installation errors, allowing fast, secure wiring of all components. The pluggable installation connector is protected in accordance with protection type IP20 (When mated: IP2xC (These compact connectors are not designed for use in open, easily accessible areas!)). This means that users' fingers will never come into contact with electrified elements. The **WINSTA**® MIDI pluggable installation connector with A coding in black or white is usually used for general mains applications in power distribution. Important parameters in the selection of a pluggable installation connector are the rated current and voltage: They provide information about possible domains of use and applications. This product has a current rating of 25 A – so it is also suitable for robust loads. **WINSTA**® MIDI with Push-in CAGE CLAMP® spring pressure connection technology is used in can be found in a variety of projects you can use for quick, easy, flexible, and secure electrical installation.

WINSTA® MIDI solutions for your electrical installation – protected against mismatching and maintenance-free

Subject to changes. Please also observe the further product documentation!

WAGO GmbH & Co. KG
Hansastr. 27
32423 Minden
Phone: +49571 887-0 | Fax: +49571 887-169
Email: info.de@wago.com | Web: www.wago.com

Do you have any questions about our products?
We are always happy to take your call at +49 (571) 887-44222.



The WINSTA® Pluggable Connection System allows pluggable electrical installation. This significantly reduces the need for servicing and lowers costs. Choose durability and quality – the WINSTA® MIDI pluggable installation connector with locking lever from WAGO makes the electrical installation of electrical components noticeably easier.

- pluggable installation connectors with protection against mismatching
- for automation controllers
- with A coding for a great number of applications
- exact dimensions
- fast, secure installation

Data

Electrical data

Ratings per IEC/EN

Ratings per	IEC/EN 60664-1
Nominal voltage (III/3)	400 V
Rated impulse voltage (III/3)	6 kV
Rated current	25 A
Legend (ratings)	(III / 3) ≙ Overvoltage category III / Pollution degree 3

Ratings per UL 1977

Note for the US market	Some versions may also be used for current interruption in accordance with the UL certificate in select applications with currents below 16 A and voltages up to 600 V. For further information, please contact your local sales office.
Rated voltage (UL 1977)	600 V
Rated current UL 1977	23 A

General

Note on contact resistance	approx. 1 mΩ of contact resistance approx. 0.25 mΩ contact transition plug/socket
----------------------------	--

Connection data

Total number of potentials	4
PE function	Preceding PE contact

Subject to changes. Please also observe the further product documentation!



Connection 1

Pole number	4
-------------	---

Physical data

Pin spacing	10 mm / 0.394 inches
Width	40 mm / 1.575 inches
Height	36.7 mm / 1.445 inches
Depth	51 mm / 2.008 inches

Mechanical Data

Application	General mains applications
Coding	A
Marking	N \perp 2/L 1/L'
Potential marking	N \perp 2/L 1/L'
Mating force of a plug-in connection	approx. 20 ... 70 N (depending on pole number)
Retention force of a plug-in connection	When locked: > 80 N
Unmating force of a plug-in connection	Unlocked: approx. 20 ... 70 N (depending on pole number)
Number of mating cycles	200, without resistive load
Type of distribution box	h-distribution connector, outputs on one side
Protection type	IP20; When mated: IP2xC (These compact connectors are not designed for use in open, easily accessible areas!)

Plug-in connection

Contact type (pluggable connector)	Socket/plug
Mismating protection	Yes
Note on mismating protection	All <i>WINSTA</i> [®] components are 100% protected against mismating when: a.) plugging different numbers of poles b.) plugging while rotated 180 c.) plugging while laterally staggered d.) plugging one pole
Locking lever	yes
Locking of plug-in connection	locking lever
Note on locking system	All connectors for mounted installations (snap-in versions for lighting fixtures or devices, all types of PCB and distribution connectors) are factory-equipped with locking levers to ensure

Subject to changes. Please also observe the further product documentation!



plugs and sockets are securely locked. Additional locking levers are only required for flying leads (plug/socket).

Material Data

Note (material data)

Information on material specifications can be found here

Color	black
Insulation material	Polyamide (PA66)
Flammability class per UL94	V0
Contact material	Copper or copper alloy; surface-treated
Contact plating	Tin
Fire load	2.95 MJ
Weight	31.6 g

Environmental requirements

Processing temperature	-5 ... +40 °C
Continuous operating temperature	-35 ... +85 °C
Note on continuous operating temperature	Insulating parts for temperatures ≤ 105 °C

Commercial data

Product Group	20 (Winsta)
eCl@ss 10.0	27-44-06-03
eCl@ss 9.0	27-44-06-03
ETIM 8.0	EC002567
ETIM 7.0	EC002567
PU (SPU)	25 pcs
Packaging type	box
Country of origin	DE
GTIN	4045454982034
Customs tariff number	85366990990

Environmental Product Compliance

RoHS Compliance Status	Compliant, No Exemption
------------------------	-------------------------

Approvals / Certificates

General approvals







Subject to changes. Please also observe the further product documentation!

WAGO GmbH & Co. KG
 Hansastr. 27
 32423 Minden
 Phone: +49571 887-0 | Fax: +49571 887-169
 Email: info.de@wago.com | Web: www.wago.com

Do you have any questions about our products?
 We are always happy to take your call at +49 (571) 887-44222.



Logo	Approval	Additional Approval Text	Certificate name
	cURus Underwriters Laboratories Inc.	UL 1977	E45171

Counterpart

	Item no.770-114 Plug; with strain relief housing; 4-pole; Cod. A; 4,00 mm ² ; black	www.wago.com/770-114
	Item no.770-104 Socket; with strain relief housing; 4-pole; Cod. A; 4,00 mm ² ; black	www.wago.com/770-104
	Item no.770-204 Socket; 4-pole; Cod. A; 4,00 mm ² ; black	www.wago.com/770-204
	Item no.771-9994/006-101 pre-assembled interconnecting cable; Eca; Socket/plug; 4-pole; Cod. A; H05VV-F 4G 1.5 mm ² ; 1 m; 1,50 mm ² ; black	www.wago.com/771-9994/006-101
	Item no.770-214 Plug; 4-pole; Cod. A; 4,00 mm ² ; black	www.wago.com/770-214
	Item no.771-9994/106-101 pre-assembled connecting cable; Eca; Socket/open-ended; 4-pole; Cod. A; H05VV-F 4G 1.5 mm ² ; 1 m; 1,50 mm ² ; black	www.wago.com/771-9994/106-101
	Item no.771-9994/206-101 pre-assembled connecting cable; Eca; Plug/open-ended; 4-pole; Cod. A; H05VV-F 4G 1.5 mm ² ; 1 m; 1,50 mm ² ; black	www.wago.com/771-9994/206-101

Optional accessories

Cover

Cover		
	Item no.: 770-360 Lockout cap; for plugs; 5-pole; separable; yellow	www.wago.com/770-360
	Item no.: 770-201 Lockout cap; 12-pole, separable; for sockets; Plastic; black	www.wago.com/770-201
	Item no.: 770-221 Lockout cap; 12-pole, separable; for sockets; Plastic; white	www.wago.com/770-221

Mounting

Mounting accessories

Subject to changes. Please also observe the further product documentation!



Item no.: 770-624

Mounting plate; 4-pole; for distribution connectors; Plastic; black

www.wago.com/770-624



Item no.: 770-674

Mounting plate; 4-pole; for distribution connectors; Plastic; white

www.wago.com/770-674

Downloads

Documentation

Bid Text

770-944 X81 - Datei	2019 Feb 19	xml 2.8 kB	Download
770-944 doc - Datei	2015 Mar 12	doc 23.6 kB	Download

CAD/CAE-Data

CAE data

ZUKEN Portal 770-944	URL	Download
WSCAD Universe 770-944	URL	Download

CAD data

2D/3D Models 770-944	URL	Download
----------------------	-----	----------

Environmental Product Compliance

Compliance Search

Environmental Product Compliance 770-944 h-distribution connector; 4-pole; Cod. A; 1 input; 2 outputs; outputs on one side; 2 locking levers; black	URL	Download
--	-----	----------

Installation Notes

Subject to changes. Please also observe the further product documentation!

WAGO GmbH & Co. KG
Hansastr. 27
32423 Minden
Phone: +49571 887-0 | Fax: +49571 887-169
Email: info.de@wago.com | Web: www.wago.com

Do you have any questions about our products?
We are always happy to take your call at +49 (571) 887-44222.

Installation

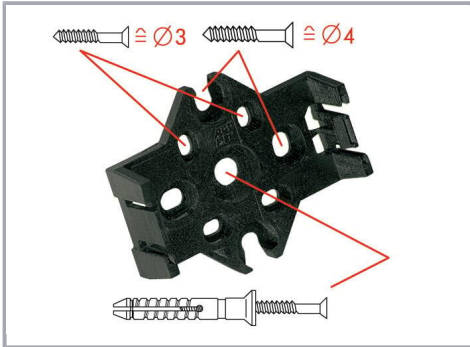

Mounting plates can be secured using commercially available screws or nail-drive anchors.



The distribution connectors snap together when attached to the mounting plate.



To release the distribution connector, unlock the latch using a screwdriver.

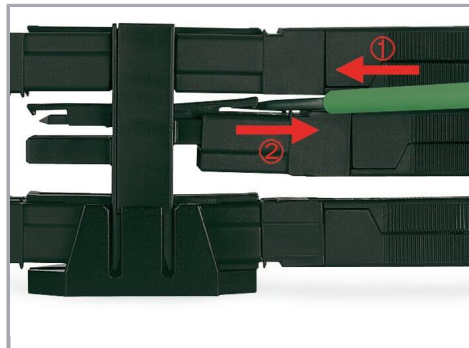

All distribution connector connections are locked and protected against accidental disconnection directly after mating. Locking of any connection is released using a screwdriver, even if all connections are used.

Product family

WINSTA® MIDI

[Show all products from the family](#)

Subject to changes. Please also observe the further product documentation!