

# Hardware Reference Manual

REV. April 2021

---

## Blackbird

**(VL-EPU-  
4562/4462)**

Intel® Core™-based Embedded  
Processing Unit with SATA, Dual  
Ethernet, USB, Digital I/O, Serial,  
Video, Mini PCIe Sockets, SPX,  
Trusted Platform Module





[WWW.VERSALOGIC.COM](http://WWW.VERSALOGIC.COM)

12100 SW Tualatin Road  
Tualatin, OR 97062-7341  
(503) 747-2261  
Fax (971) 224-4708

Copyright © 2017-2021 VersaLogic Corp. All rights reserved.

**Notice:**

Although every effort has been made to ensure this document is error-free, VersaLogic makes no representations or warranties with respect to this product and specifically disclaims any implied warranties of merchantability or fitness for any particular purpose.

VersaLogic reserves the right to revise this product and associated documentation at any time without obligation to notify anyone of such changes.

\* Other names and brands may be claimed as the property of others.

## Product Revision Notes

Revision 1.00	Initial release
Revision 1.01	Replaced block diagram
Revision 1.02	Updated Web links and WDT information
Revision 1.03	Updated Power Connector Pinout diagram (Figure 7)
Revision 1.04	Replaced Power Connector Pinout diagram (Figure 7)
Revision 1.05	Removed heat pipe information
Revision 1.06	Consolidated DIO information in Chapter 10
Revision 1.07	Added battery RTC note
Revision 1.08	Replaced Figure 31
Revision 1.09	Added header part numbers for paddleboard user I/O (Table 20 notes)
Revision 1.10	Added note 4 to Table 9 (10K pullup for the I <sup>2</sup> C signals)
Revision 1.11	Updated the ground notice on page iv
Revision 1.12	Updated the BIOS Setup section
Revision 1.13	Updated Figure 29
Revision 1.15	Updated LVDS connector information (Page 51)
Revision 1.16	Added max thermal note for EPU-4562 ECPxxx models (Page 72)
Revision 1.20	Updated SKU information (Pages 18-19) Updated CBR-4005B image (Figure 25)
Revision 1.21	Updated the Molex part numbers on page 24
Revision 1.22	Added Audio information and pinout on page 50
Revision 1.23	Updated table 15

## Support Page

The [Blackbird Product Page](#) contains additional information and resources for this product including:

- Operating system information and software drivers
- Data sheets and manufacturers links for chips used in this product
- BIOS information and upgrades

## Customer Support

If you are unable to solve a problem after reading this manual or visiting the product support page, contact VersaLogic Technical Support at (503) 747-2261. VersaLogic support engineers are also available via e-mail at [Support@VersaLogic.com](mailto:Support@VersaLogic.com).

## Repair Service

If your product requires service, you must obtain a Returned Material Authorization (RMA) number by calling 503-747-2261. Be ready to provide the following information:

- Your name, the name of your company, your phone number, and e-mail address
- The name of a technician or engineer that can be contacted if any questions arise
- The quantity of items being returned
- The model and serial number (barcode) of each item

- A detailed description of the problem
- Steps you have taken to resolve or recreate the problem
- The return shipping address

**Warranty Repair** All parts and labor charges are covered, including return shipping charges for UPS Ground delivery to United States addresses.

**Non-warranty Repair** All approved non-warranty repairs are subject to diagnosis and labor charges, parts charges and return shipping fees. Specify the shipping method you prefer and provide a purchase order number for invoicing the repair.

**Note:** Mark the RMA number clearly on the outside of the box before returning.

## Cautions

### Electrostatic Discharge



**CAUTION:**

Electrostatic discharge (ESD) can damage circuit boards, disk drives, and other components. The circuit board must only be handled at an ESD workstation. If an approved station is not available, some measure of protection can be provided by wearing a grounded antistatic wrist strap. Keep all plastic away from the board, and do not slide the board over any surface.

After removing the board from its protective wrapper, place the board on a grounded, static-free surface, component side up. Use an antistatic foam pad if available.

The board should also be protected inside a closed metallic antistatic envelope during shipment or storage.

**Note:** The exterior coating on some metallic antistatic bags is sufficiently conductive to cause excessive battery drain if the bag comes in contact with the bottom side of the Blackbird.

### Handling Care



**CAUTION:**

Avoid touching the exposed circuitry with your fingers when handling the board. Though it will not damage the circuitry, it is possible that small amounts of oil or perspiration on the skin could have enough conductivity to cause the contents of CMOS RAM to become corrupted through careless handling, resulting in CMOS resetting to factory defaults.

## Grounding



### CAUTION:

All mounting standoffs are signal ground. For example, if metal standoffs are used to mount to an earth-grounded chassis, it is highly recommended to isolate the standoffs from the chassis.

# Contents

---

<b>Introduction .....</b>	<b>10</b>
Features .....	10
Technical Specifications .....	11
Block Diagram .....	12
Dimensions and Mounting .....	13
Blackbird Dimensions .....	13
<b>Configuration and Setup .....</b>	<b>14</b>
Initial Configuration .....	14
Basic Setup .....	14
BIOS Setup .....	16
Default BIOS Setup Values .....	16
Operating System Installation .....	16
Jumper Blocks .....	17
Jumper As-Shipped Configuration .....	17
Jumper Configuration Summary .....	17
<b>Board Features .....</b>	<b>19</b>
CPU .....	19
CPU Die Temperature .....	19
System RAM .....	19
I/O Interfaces .....	20
Real-Time Clock (RTC) .....	20
External Connectors .....	21
Baseboard Connector Locations .....	21
Power Delivery .....	23
Main Power Connector .....	23
Cabling .....	24
Power Requirements .....	24
Power Delivery Considerations .....	24
Power Button .....	25
Supported Power States .....	25
Battery Power Options .....	26
External Speaker .....	27
Push-button Reset .....	27
CPU Fan Connector .....	28
Cabling .....	29
LEDs .....	29
Power-Good/Fault Indicator LEDs .....	31
<b>Mass Storage Interfaces .....</b>	<b>32</b>
SATA Interface .....	32
<b>Multi-purpose I/O .....</b>	<b>34</b>
USB Interfaces .....	34
Mini PCIe Sockets .....	35

W_DISABLE# Signal.....	37
Mini PCIe Card Status LEDs.....	38
User I/O Connector.....	39
Cabling.....	40
Analog-to-Digital and Digital to Analog Converter Interface.....	41
Cabling.....	42
SPX™ Expansion Bus.....	43
Cabling.....	44
<b>Serial I/O.....</b>	<b>45</b>
Serial Ports.....	45
Serial Port Connector Pinout.....	46
Cabling.....	46
COM Port Configuration.....	47
Console Redirection.....	47
<b>Audio and Video Interfaces.....</b>	<b>48</b>
Mini DisplayPort++ (DP++) Connectors.....	48
VGA Output.....	50
Audio Output.....	50
LVDS Interface.....	51
LVDS Flat Panel Display Connector.....	51
LVDS Backlight Connector.....	53
<b>Network Interfaces.....</b>	<b>54</b>
Ethernet Connector.....	54
Cabling.....	55
Ethernet Status LEDs.....	56
<b>VL-CBR-4005B Paddleboard.....</b>	<b>57</b>
VL-CBR-4005B Connectors and Indicators.....	57
User I/O Connector.....	58
Cabling.....	59
On-board Battery.....	59
Auxiliary I/O Connector.....	60
Dimensions and Mounting Holes.....	61
<b>Digital and Analog I/O Paddleboards.....</b>	<b>62</b>
Analog I/O (Using VL-CBR-2004).....	62
Dimensions and Mounting Holes.....	63
Digital I/O (Using VL-CBR-2005).....	64
Voltage.....	65
<b>Thermal Considerations.....</b>	<b>66</b>
Selecting the Correct Thermal Solution for Your Application.....	66
Heat Plate.....	66
System-level Considerations.....	66
CPU Thermal Trip Points.....	67
Thermal Specifications, Restrictions, and Conditions.....	69
Overall Restrictions and Conditions:.....	69
Heat Plate Only Restrictions and Conditions:.....	69
Heat Sink Only Considerations:.....	69

Heat Sink with Fan Considerations: .....	69
EPU-4562/4462 Thermal Characterization.....	70
Test Results.....	71
Hardware Assembly.....	73
Installing the VL-HDW-417 Passive Heat Sink .....	74
Installing the VL-HDW-418 Heat Sink Fan .....	75
<b>KNOWN ISSUES .....</b>	<b>76</b>

## Figures

Figure 1. Blackbird (VL-EPU-4562/4462) Block Diagram.....	12
Figure 2. Blackbird Dimensions and Mounting Holes.....	13
Figure 3. Typical Development Configuration .....	15
Figure 4. Jumpers As-Shipped Configuration.....	17
Figure 5. Top Baseboard Connector Locations.....	21
Figure 6. Bottom Baseboard Connector Locations .....	22
Figure 7. Main Power Connector Pin Orientation.....	23
Figure 8. Location and Pin Orientation of the Battery Connector .....	26
Figure 9. VL-CBR-0203 Latching Battery Module .....	27
Figure 10. Location and Pin Orientation of the CPU Fan Connector .....	28
Figure 11. Location of Status Indicator LEDs .....	29
Figure 12. Location of the SATA Connectors .....	32
Figure 13. Location of the USB Ports .....	34
Figure 14. Location of Mini PCIe Sockets.....	35
Figure 15. Mini PCIe Status LEDs.....	38
Figure 16. Location and Pin Orientation of the User I/O Connector .....	39
Figure 17. Location and Pin Orientation of the Analog-to-Digital Input Connector .....	41
Figure 18. SPX Connector Location and Pin Configuration.....	43
Figure 19. Location and Pin Orientation of the Serial I/O Connectors .....	45
Figure 20. Location of the Mini DisplayPort++ Connector .....	49
Figure 21. VL-CBR-2032 Mini DisplayPort to VGA Adapter .....	50
Figure 22. Location of the LVDS Connectors .....	51
Figure 23. Location and Pin Orientation of the Ethernet Connector.....	54
Figure 24. Onboard Ethernet Status LEDs.....	56
Figure 25. VL-CBR-4005B Connectors, Switches, and LEDs .....	57
Figure 26. Location and Pin Orientation of the User I/O Connector .....	58
Figure 27. Location and Pin Orientation of Auxiliary I/O Connector .....	60
Figure 28. VL-CBR-4005B Dimensions and Mounting Holes .....	61
Figure 29. Analog I/O and Ground Terminal Block Pinouts .....	63
Figure 30. CBR-2004B/CBR-2005 Dimensions and Mounting Holes .....	63
Figure 31: Digital I/O Connector (J30).....	64
Figure 32. Digital I/O and Ground Terminal Block Pinouts .....	65
Figure 33. EPU-4562-EBP Quad Core Temperature Relative to Ambient Temperature.....	71
Figure 34. EPU-4562-ECP Quad Core Temperature Relative to Ambient Temperature.....	72
Figure 35. Hardware Assembly with Heat Plate Down .....	73
Figure 36. Installing the Passive Heat Sink.....	74
Figure 37. Installing the Heat Sink Fan.....	75



## Tables

---

Table 1: Jumper Block Configurations .....	17
Table 2: Blackbird Memory Characteristics.....	19
Table 3: Main Power Connector Pinout.....	24
Table 4: Supported Power States .....	25
Table 5: CPU Fan Connector Pinout.....	28
Table 6: SATA Port Configuration .....	33
Table 7: Mini PCIe / mSATA Socket Pinout.....	36
Table 8: Mini PCIe Card Status LEDs .....	38
Table 9: User I/O Connector Pinout and Pin Orientation .....	40
Table 10: Analog-to-Digital and Digital to Analog Input Connector Pinout.....	42
Table 11: SPX Connector Pinout .....	44
Table 12: COM1/COM2 Connector Pinout .....	46
Table 13: COM3/COM4 Connector Pinout .....	46
Table 14: Mini DisplayPort++ Connector Pinout .....	49
Table 15: Audio Connector Pinout (J20) .....	50
Table 16: LVDS Flat Panel Display Connector Pinout.....	51
Table 17: LVDS Backlight Connector Pinout.....	53
Table 18: Ethernet Connector Pinout .....	55
Table 19: Ethernet Status LED Details .....	56
Table 20: User I/O Connector Pinout.....	58
Table 21: Auxiliary I/O Connector Pinout.....	60
Table 22: CBR-2004B Pinouts.....	62
Table 23: Digital I/O Pinout.....	65
Table 24: CPU Thermal Trip Points.....	67
Table 25: Temperature Monitoring Programs.....	68
Table 26: Absolute Minimum and Maximum Air Temperatures .....	69
Table 27: EPU-4562/4462 Thermal Testing Setup .....	70

## Features

The Blackbird (VL-EPU-4562/4462) is a compact, rugged x86 type board-level embedded computer. It is designed and tested to meet military and medical requirements for smaller, lighter, low power embedded systems. The Blackbird is a member of the VersaLogic family of ultra-rugged embedded x86 computers. This embedded computer, equipped with a 6th Generation Intel Core\* “Skylake” processor, is designed to withstand extreme temperature, impact, and vibration.

This embedded computer, equipped with an Intel Core processor, is designed to withstand extreme temperature, impact, and vibration. Its features include:

- Options for Intel Core\* “SkyLake” dual and quad core processors with clock rates up to 2.0 GHz
- Integrated high-performance video. Intel HD 520 and 530 - Gen-9 compute architecture, 24 execution units, and GPU Turbo Boost. Supports DirectX 12, OpenGL 4.4, OpenCL 2.0.
- Dual Mini DisplayPort and LVDS video outputs. LVDS backlight control
- Up to 32 GB DDR4 memory
- Dual Gigabit Ethernet ports
- Dual USB 3.0 port and four USB 2.0 ports support keyboard, mouse, and other devices
- Four RS-232/422/485 serial ports, audio output, and I<sup>2</sup>C support
- Trusted Platform Module
- Three 8254 timer/counters
- On-board data acquisition support. Eight multi-range analog inputs, four analog outputs, and twenty four 3.3V digital I/O lines
- Dual 6 Gb/s SATA ports support bootable SATA hard drives
- Two Full and one half-sized Mini PCIe Card sockets. Supports Wi-Fi modems, GPS, MIL-STD-1553, Ethernet, flash data storage with auto-detect mSATA flash storage support, and other mini PCIe modules.
- Support for SPI and SPX devices, including low cost analog and digital modules.
- Customization available

The Blackbird is compatible with popular operating systems including Microsoft\* Windows\* 10/WES7, and Linux (see the [VersaLogic Support](#)).

Blackbird EPUs receive 100% functional testing and are backed by a limited five-year warranty. Careful parts sourcing and US-based technical support ensure the highest possible quality, reliability, service, and product longevity for this exceptional EPU.

## Technical Specifications

Refer to the [Blackbird Product Page](#) for complete specifications. Specifications are subject to change without notification.



## Dimensions and Mounting

### Blackbird Dimensions

The figure below provides the board's dimensions (COM Express Basic size base).

**Figure 2. Blackbird Dimensions and Mounting Holes**

*(Not to scale. All dimensions in millimeters.)*

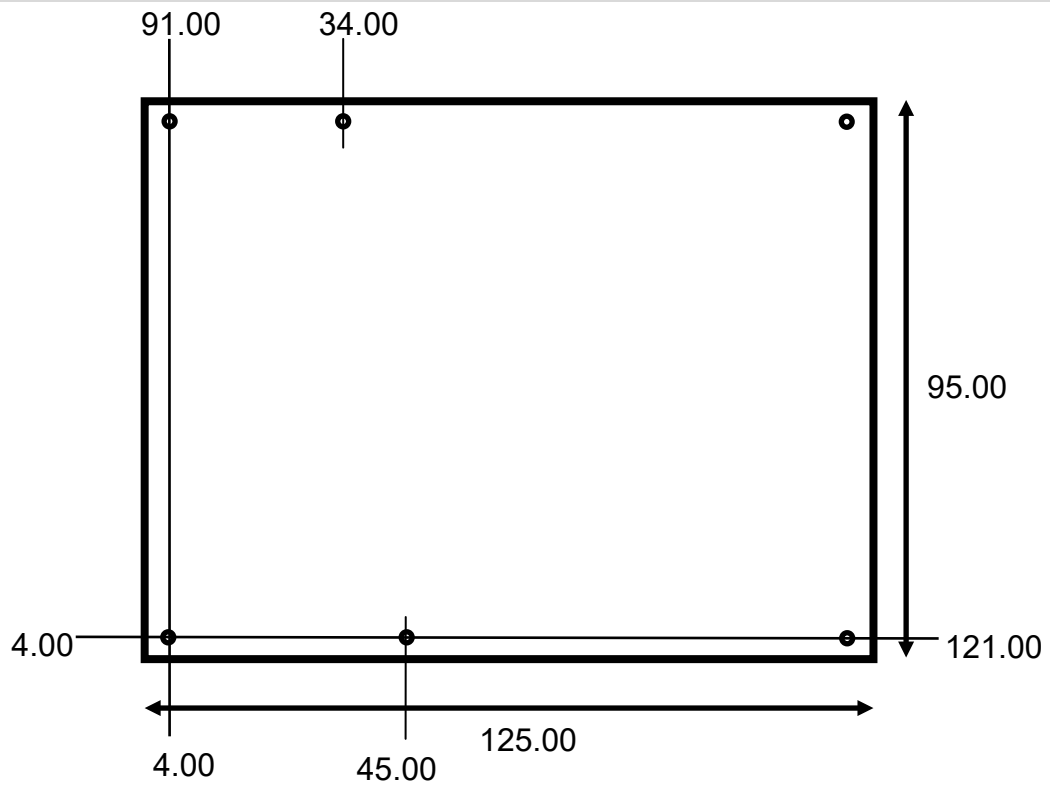

## Initial Configuration

The following components are recommended for a typical development system with the Blackbird EPU:

- ATX power supply
- VL-CBR-4005B paddleboard and VL-CBR-4005A cable. Refer to the chapter titled “VL-CBR-4005B Paddleboard”, beginning on page 57 for details on the VL-CBR-4005B paddleboard.
- USB keyboard and mouse
- SATA hard drive
- USB CD-ROM drive
- VGA monitor and a VL-CBR-2032 Mini DisplayPort-to-VGA adapter
- A thermal solution (using either VersaLogic accessories or a customer-designed solution)

You will also need an operating system (OS) installation CD-ROM.

## Basic Setup

The following steps outline the procedure for setting up a typical development system. The Blackbird should be handled at an ESD workstation or while wearing a grounded antistatic wrist strap.

Before you begin, unpack the Blackbird and accessories. Verify that you received all the items you ordered. Inspect the system visually for any damage that may have occurred in shipping. Contact [Support@VersaLogic.com](mailto:Support@VersaLogic.com) immediately if any items are damaged or missing.

Gather all the peripheral devices you plan to attach to the Blackbird as well as their interface and power cables. Attach standoffs to the board to stabilize it and make it easier to work with.

The next figure shows a typical setup for the Blackbird in the development environment.

Figure 3. Typical Development Configuration

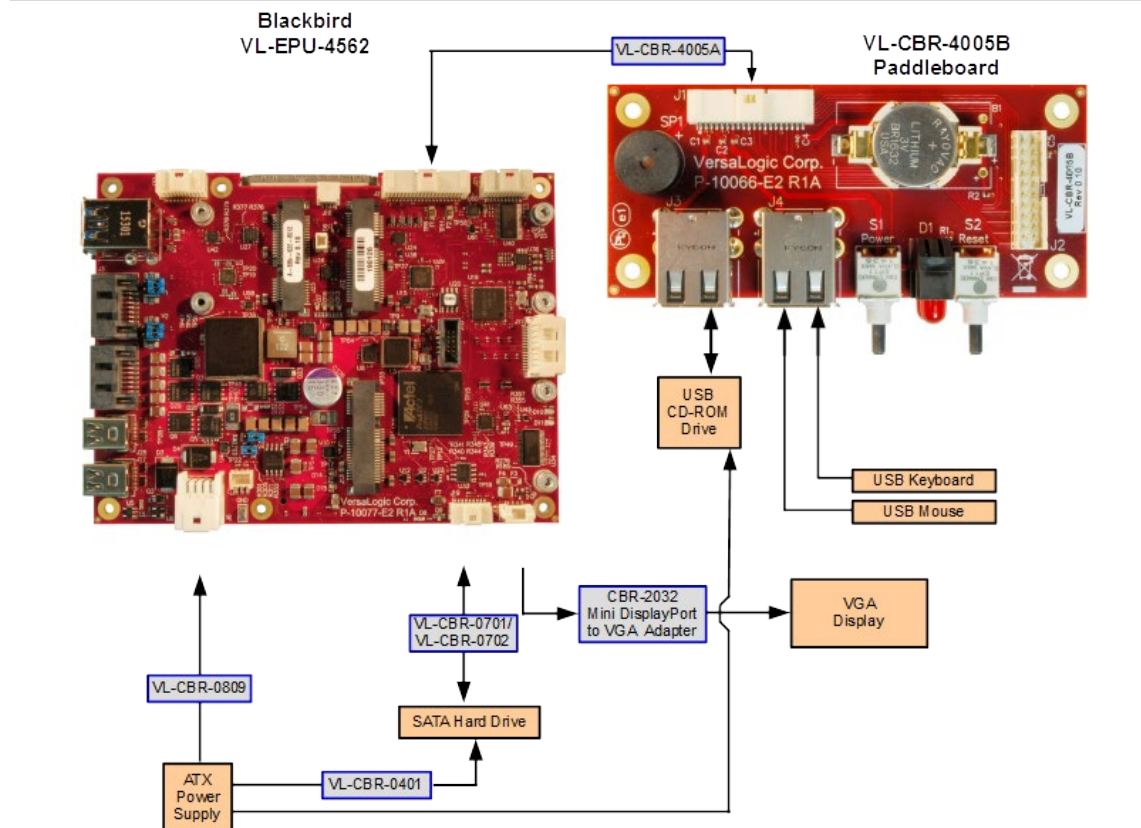

### 1. Attach Cables and Peripherals

- Attach a VGA monitor to either of the baseboard's Mini DisplayPort++ connectors using a VL-CBR-2032.
- Attach a SATA hard disk to either of the baseboard's SATA connectors using a VL-CBR-0701 or VL-CBR-0702 cable.
- Attach a VL-CBR-4005B paddleboard to the baseboard's User I/O connector.
- Connect a USB keyboard and USB mouse to one of the USB Type-A connectors on the VL-CBR-4005B paddleboard.
- Attach a USB CD-ROM drive to one of the USB Type-A connectors on the VL-CBR-4005B paddleboard.

### 2. Connect Power Source

- Plug the power adapter cable VL-CBR-0809 into the main power connector on the baseboard. Attach the motherboard connector of the ATX power supply to the adapter.
- Attach an ATX power cable to any 3.5-inch drive that is not already attached to the power supply (hard drive or CD-ROM drive).

### 3. Install Thermal Solution

- See Installing VersaLogic Thermal Solutions.

#### 4. Review Configuration

- Before you power up the system, double-check all the connections. Make sure all cables are oriented correctly, that adequate power is supplied to the Blackbird and all attached peripheral devices.

#### 5. Power On

- Turn on the ATX power supply and the video monitor. If the system is correctly configured, a video signal should be present.

#### 6. Install Operating System

- Install the operating system according to the instructions provided by the operating system manufacturer.

## BIOS Setup

The Blackbird permits the storage of user-defined BIOS settings. This enables you to retrieve those settings from cleared or corrupted CMOS RAM, or battery failure. All BIOS defaults can be changed, except the time and date. BIOS defaults are updated using the BIOS Update Utility.

**CAUTION:** If BIOS default settings make the system unbootable and prevent the user from entering the BIOS Setup utility, the Blackbird must be serviced by the factory.

### Default BIOS Setup Values

After CMOS RAM clears, the system loads default BIOS parameters the next time the board powers on. The default CMOS RAM setup values are used in order to boot the system whenever the main CMOS RAM values are blank, or when the system battery is dead or has been removed from the board.

## Operating System Installation

The standard PC architecture used on the Blackbird makes the installation and use of most of the standard x86-based operating systems very simple. The operating systems listed on the [VersaLogic Software Support](#) page use the standard installation procedures provided by the maker of the operating system. Special optimized hardware drivers for a particular operating system, or a link to the drivers, are available on the [Blackbird Product Page](#).



# Jumper Blocks

## Jumper As-Shipped Configuration

Figure 4. Jumpers As-Shipped Configuration

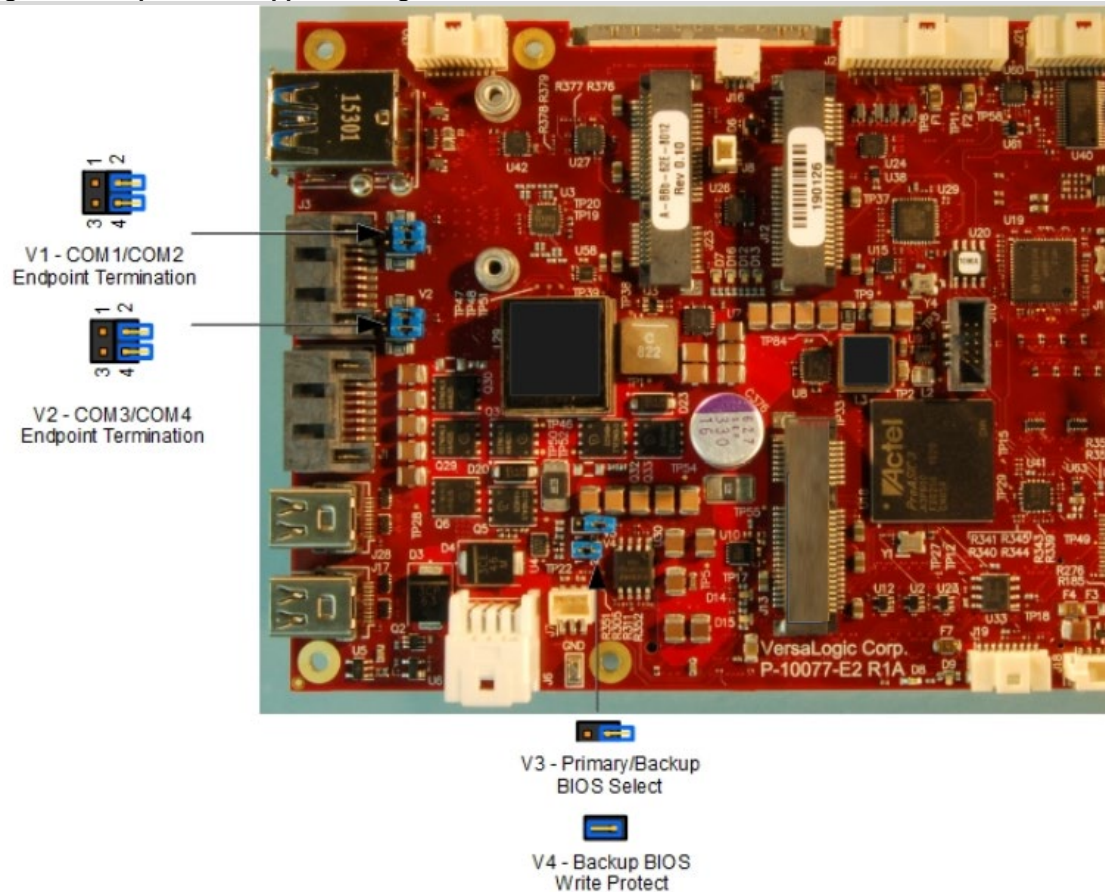

## Jumper Configuration Summary

Table 1: Jumper Block Configurations

Jumper Block	Pins	Function	Description
V1	1-2	COM1 Endpoint Termination	<ul style="list-style-type: none"> <li>Jumper In: Endpoint termination (for RS-485 or RS-422)</li> <li><b>Jumper Out: Not terminated (RS-232) (default)</b></li> </ul>
	3-4	COM2 Endpoint termination	<ul style="list-style-type: none"> <li>Jumper In: Endpoint termination (for RS-485 or RS-422)</li> <li><b>Jumper Out: Not terminated (RS-232) (default)</b></li> </ul>
V2	1-2	COM3 Endpoint Termination	<ul style="list-style-type: none"> <li>Jumper In: Endpoint termination (for RS-485 or RS-422)</li> <li><b>Jumper Out: Not terminated (RS-232) (default)</b></li> </ul>
	3-4	COM4 Endpoint termination	<ul style="list-style-type: none"> <li>Jumper In: Endpoint termination (for RS-485 or RS-422)</li> <li><b>Jumper Out: Not terminated (RS-232) (default)</b></li> </ul>

Jumper Block	Pins	Function	Description
V3	1-2	Primary/Backup BIOS Select	<ul style="list-style-type: none"><li>▪ Jumper In: Use Backup BIOS on the base board</li><li>▪ <b>Jumper Out: Use Primary BIOS on the COM Express Module (default)</b></li></ul>
V4	1-2	Backup BIOS Write Protect	<ul style="list-style-type: none"><li>▪ <b>Jumper In: Backup BIOS is write-protected (default)</b></li><li>▪ Jumper Out: Backup BIOS is not write-protected</li></ul>

**Note:** Backup BIOS write protection is not currently implemented

# Board Features

# 3

## CPU

The Intel Core\* SoC features integrated 3D graphics, video encode and decode, and memory and display controllers in one package. The following CPU configurations are available:

- VL-EPU-4462-EAP-08: Intel Core i3-6100U – 2.3 GHz, Dual Core (8 GB memory support)
- VL-EPU-4462-EBP-16: Intel Core i5-6300U – 2.4 GHz, Dual Core (16 GB memory support)
- VL-EPU-4562-ECP-16: Intel Core i7-6822EQ – 2.0 GHz, Quad Core (16 GB memory support)
- VL-EPU-4562-ECP-32: Intel Core i7-6822EQ – 2.0 GHz, Quad Core (32 GB memory support)
- VL-EPU-4562-WCP-16: Intel Core i7-6822EQ – 2.0 GHz, Quad Core (16 GB memory support)
- VL-EPU-4562-WCP-32: Intel Core i7-6822EQ – 2.0 GHz, Quad Core (32 GB memory support)

### CPU Die Temperature

The CPU die temperature is affected by numerous conditions, such as CPU utilization, CPU speed, ambient air temperature, airflow, thermal effects of adjacent circuit boards, external heat sources, and many others.

The thermal management for the Intel Core series of processors consists of a sensor located in the core processor area. The processor contains multiple techniques to help better manage thermal attributes of the processor. It implements thermal-based clock throttling and thermal-based speed step transitions. There is one thermal sensor on the processor that triggers Intel's thermal monitor (the temperature at which the thermal sensor triggers the thermal monitor is set during the fabrication of the processor). Triggering of this sensor is visible to software by means of the thermal interrupt LVT entry in the local APIC.

## System RAM

The Blackbird has DDR4 memory with the following characteristics:

**Table 2: Blackbird Memory Characteristics**

Board Model	Memory Type	Capacity	Data Rate
VL-EPU-4562-WCP-16	DDR4	16 GB	2133 MT/s – Single Channel
VL-EPU-4562-WCP-32	DDR4	32 GB	2133 MT/s – Dual Channel
VL-EPU-4462-EAP-08	DDR4	8 GB	2133 MT/s – Single Channel
VL-EPU-4462-EBP-16	DDR4	16 GB	2133 MT/s – Single Channel
VL-EPU-4562-EBP-16	DDR4	16 GB	2133 MT/s – Single Channel
VL-EPU-4562-ECP-16	DDR4	16 GB	2133 MT/s – Single Channel

Board Model	Memory Type	Capacity	Data Rate
VL-EPU-4562-ECP-32	DDR4	32 GB	2133 MT/s – Dual Channel

\*\* **Note:** Special Order Product – Contact VersaLogic Sales for more information

## I/O Interfaces

Later chapters describe the Blackbird's I/O interfaces and their associated connectors as follows:

- Mass Storage Interfaces (SATA) beginning on page 32
- Multi-purpose I/O (USB, Mini PCIe / mSATA, User I/O), beginning on page 34
- Serial I/O, beginning on page 45
- Audio and Video Interfaces (Mini DisplayPort++ and LVDS), beginning on page 48
- Network Interfaces, beginning on page 54

## Real-Time Clock (RTC)

The Blackbird features a real-time clock/calendar (RTC) circuit. The Blackbird supplies RTC voltage in S5, S3, and S0 states, but requires an external +2.75 V to +3.3 V battery connection. Refer to the section titled Battery Power Options on page 26 for more information. The BIOS Setup utility sets the RTC.

# External Connectors

## Baseboard Connector Locations

Figure 5. Top Baseboard Connector Locations

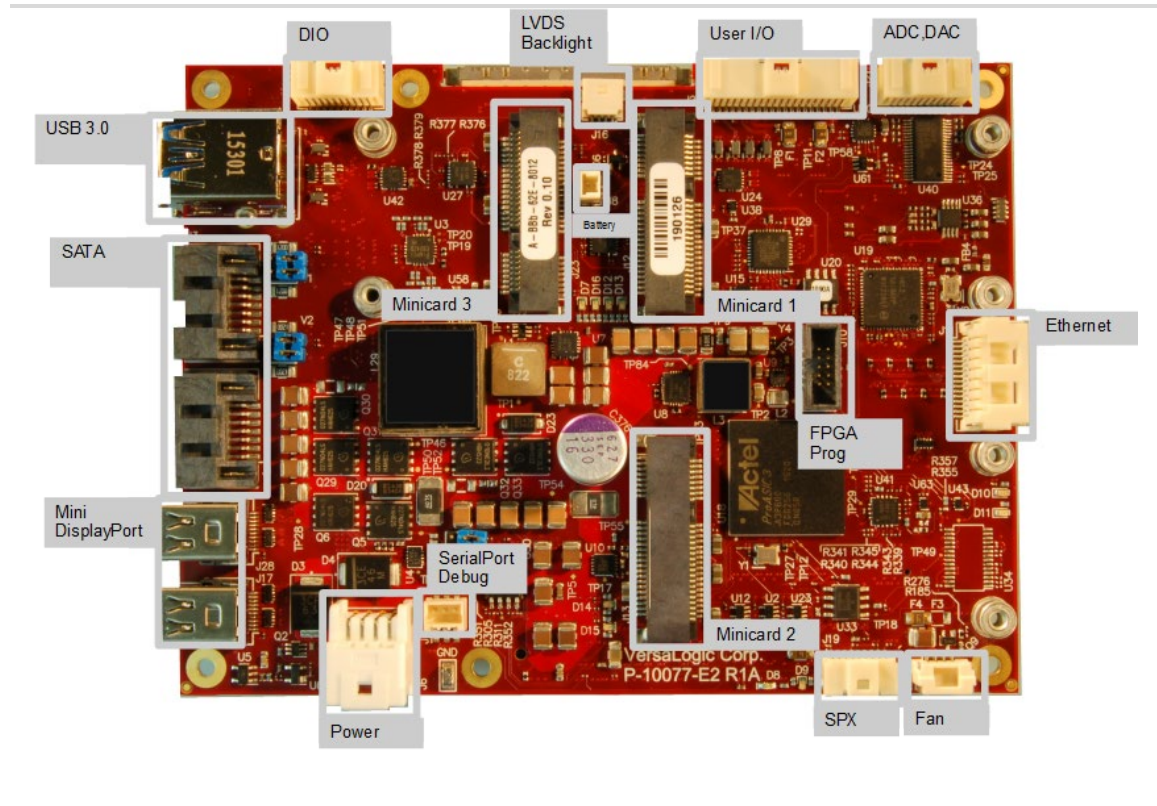
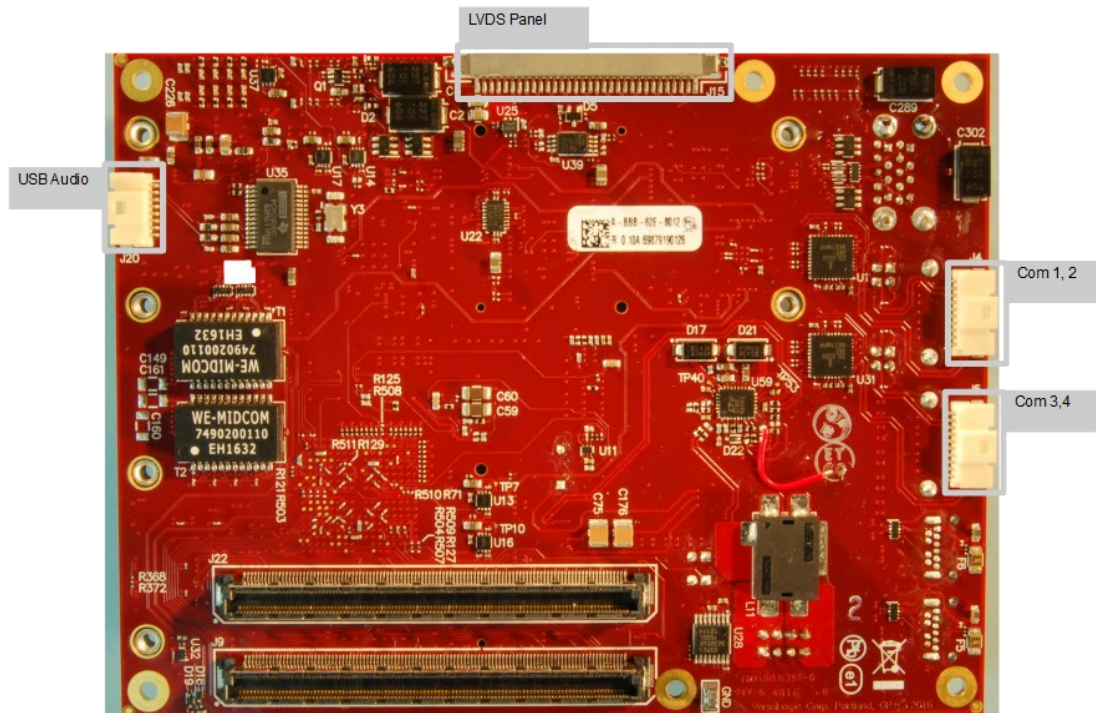

Figure 6. Bottom Baseboard Connector Locations



## Power Delivery

### Main Power Connector

An 8-pin power connector applies the Main input power to the Blackbird. The figure below shows the location and the pin orientation of the main power connector. Table 3 lists the pinout of the main power connector.

**Figure 7. Main Power Connector Pin Orientation**

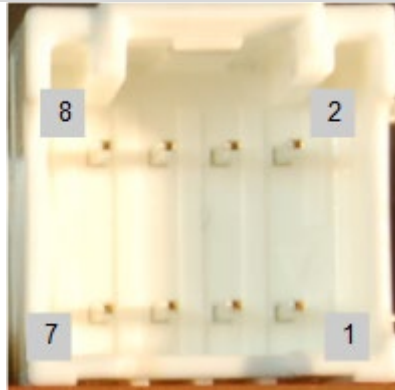



**Table 3: Main Power Connector Pinout**

Pin	Signal	Description	Pin	Signal	Description
1	PWRIN_POS	Main input voltage (+8V to +30V)	2	PWRIN_POS	Main input voltage (+8V to +30V)
3	EARTH_GND	Earth ground	4	PWRIN_POS	Main input voltage (+8V to +30V)
5	POWER_FAULT	An open-drain signal <ul style="list-style-type: none"> <li>Low if power is OK</li> <li>Open if there is a power fault (<b>Note</b>)</li> </ul>	6	PWRIN_NEG	Power return
7	PWRIN_NEG	Power return	8	PWRIN_NEG	Power return

**Note:** A power fault can be due any of the following conditions:

- The input power is off.
- The main input regulator has failed.
- The power input is under or over-voltage (not in the 8 - 30V range).

## Cabling

An adapter cable, part number VL-CBR-0809, is available for connecting the Blackbird to an ATX power supply.

If your application requires a custom cable, the following information will be useful:

VL-EPU-4562/4462 Board Connector	Mating Connector
Molex 55959-0830	Molex 51353-0800

## Power Requirements

The Blackbird requires a single +8 to +30 VDC supply capable of providing at least 35 W average power that can also provide a peak power of 60 W. The input DC supply creates both the standby and payload voltages provided to the CPU module.

The exact power requirements for the Blackbird depend on several factors, including CPU configuration (the number of cores, CPU clock rate), memory configuration, peripheral connections, and attached devices, and others.

The VersaLogic VL-PS-ATX12-300A is a 1U size ATX power supply suitable for use with the Blackbird. Use the VL-CBR-0809 adapter cable to attach the power supply to the main power connector.

## Power Delivery Considerations

Using the VersaLogic approved power supply (VL-PS-ATX12-300A) and power cable (VL-CBR-0809) will ensure high quality power delivery to the board. Customers who design their own power delivery methods should take into consideration the guidelines below to ensure good power connections.

The specifications for typical operating current do not include any off-board power usage that fed through the Blackbird power connector. Expansion boards and USB devices plugged into the board will source additional power through the Blackbird power connector.



- Do not use wire smaller than 22 AWG. Use high quality UL 1007 compliant stranded wire.
- The length of the wire should not exceed 18 inches.
- Avoid using any additional connectors in the power delivery system.
- The power and ground leads should be twisted together, or as close together as possible to reduce lead inductance.
- A separate conductor must be used for each of the power pins.
- All power input pins and all ground pins must be independently connected between the power source and the power connector.
- Use a high quality power supply that can supply a stable voltage while reacting to widely varying current draws.

### Power Button

The User I/O connector (shown in Figure 16 on page 39) includes an input for a power button. A momentary short to ground or assertion of pin 17 will cause a power button ACPI event. The button event can be configured in Windows to enter an S3 power state (Sleep, Standby, or Suspend-to-RAM), an S4 power state (Hibernate or Suspend-to-Disk), or an S5 power state (Shutdown or Soft-Off). This connector uses IEC 61000-4-2-rated TVS components to help protect against ESD damage.

A power button is provided on the VL-CBR-4005B paddleboard. Refer to the chapter titled VL-CBR-4005B Paddleboard, beginning on page 57 for more information.

### Supported Power States

The next table lists the Blackbird's supported power states.

**Table 4: Supported Power States**

Power State	Description
S0 (G0)	Working
S1 (G1-S1)	All processor caches are flushed and the CPUs stop executing instructions. Power to the CPUs and RAM is maintained. Devices that do not indicate they must remain on may be powered down.
S3 (G1-S3)	Commonly referred to as Standby, Sleep, or Suspend-to-RAM. RAM remains powered.
S4 (G1-S4)	Hibernation or Suspend-to-Disk. All content of main memory is saved to non-volatile memory, such as a hard drive, and is powered down.
S5 (G2)	Soft Off. Almost the same as G3 Mechanical Off, except that the power supply still provides power, at a minimum, to the power button to allow return to S0. A full reboot is required. No previous content is retained. Other components may remain powered so the computer can "wake" on input from the keyboard, clock, modem, LAN, or USB device.
G3	Mechanical off (ATX supply switch turned off).

## Battery Power Options

The battery circuit on the Blackbird provides power for the Real-Time Clock (RTC) and power to store BIOS Setup utility settings in non-volatile RAM.

The Blackbird has multiple options for providing battery power:

- Use an external battery (the VL-CBR-0203, for example) connected to the board through the battery connector.
- Use the battery supplied with the CBR-4005B paddleboard

**Note:** The system may occasionally not boot on the first attempt if there is no RTC battery connected and the unit has been left unpowered for more than 3 hours. When this situation occurs, the board will boot successfully when the power is switched off and then on again.

This issue can be resolved in one of two ways:

1. Always have an RTC battery connected
2. Ensure that the POST Watchdog Timer in the BIOS is enabled

The figure below shows the location and pin orientation of the battery connector.

**Figure 8. Location and Pin Orientation of the Battery Connector**

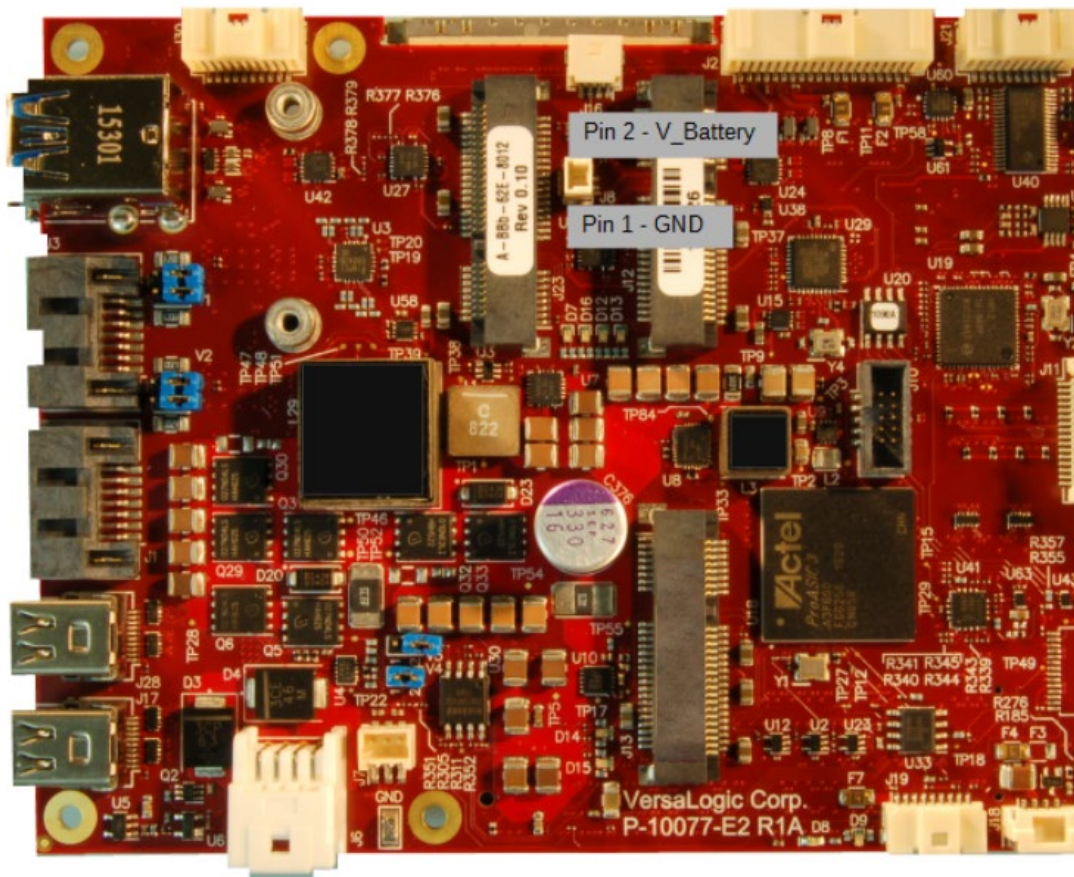

## Cabling

If your application requires a custom cable, the following information will be useful:

VL-EPU-4562/4462 Board Connector	Mating Connector
Molex 501331-0207	Molex 501330-0200

## VL-CBR-0203 External Battery Module

The VL-CBR-0203 external battery module is compatible with the Blackbird. For more information, contact [Sales@VersaLogic.com](mailto:Sales@VersaLogic.com).

**Figure 9. VL-CBR-0203 Latching Battery Module**



## External Speaker

The User I/O connector (shown in Figure 16 on page 39) includes a speaker output signal at pin 15. The VL-CBR-4005B paddleboard provides a piezoelectric speaker. Figure 25 on page 57 shows the location of the piezoelectric speaker on the VL-CBR-4005B paddleboard.

## Push-button Reset

The User I/O connector (shown in Figure 16 on page 39) includes an input for a push-button reset switch. Shorting pin 18 to ground causes the Blackbird to reboot. This must be a mechanical switch or an open-collector or open-drain active switch with less than a 0.5V low-level input when the current is 1 mA. There must be no pull-up resistor on this signal. This connector uses IEC 61000-4-2-rated TVS components to help protect against ESD damage.

A reset button on the VL-CBR-4005B paddleboard is provided. Refer to the chapter titled VL-CBR-4005B Paddleboard, beginning on page 57 for more information.

## CPU Fan Connector

The Blackbird provides a four-pin CPU fan connector. The figure below shows the location and pin orientation of the CPU fan connector.

**Figure 10. Location and Pin Orientation of the CPU Fan Connector**

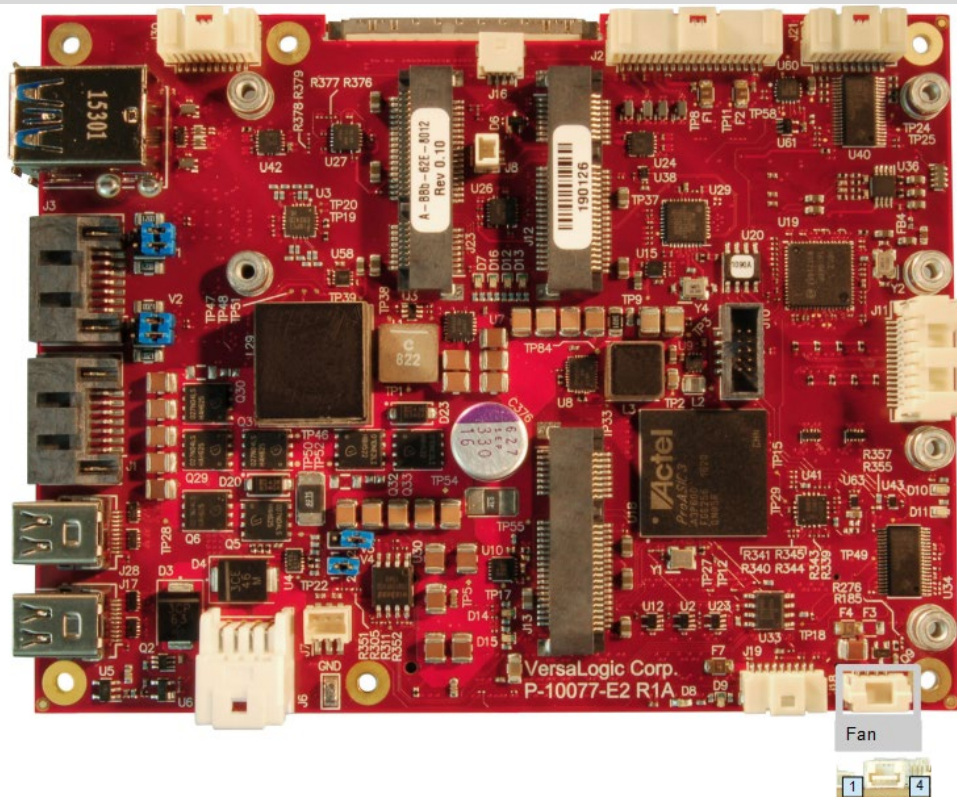

The table below provides the pinout of the CPU fan connector.

**Table 5: CPU Fan Connector Pinout**

Pin	Signal
1	Ground
2	+12 VDC ( <b>Note</b> )
3	FAN_TACH
4	FAN_CONTROL

**Note:** There is a stuffing option to change Pin 2 to V12\_S0 for custom products

## Cabling



If your application requires a custom cable, the following information will be useful:

EPU-4562/4462 Board Connector	Mating Connector
Molex 502386-0470	Molex 502380-0400

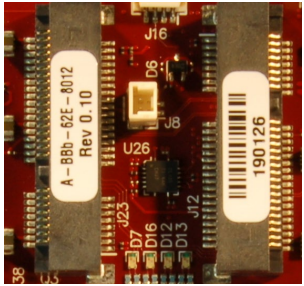

## LEDs

The figure below shows the locations of the status indicator LEDs

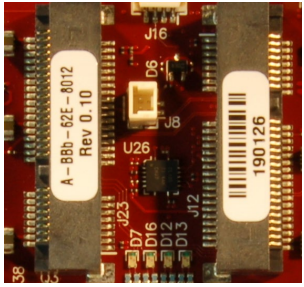
**Figure 11. Location of Status Indicator LEDs**

LED	Status Indication	Position
D7	Wireless WAN/LAN activity for module installed in Mini PCIe Socket #3 (WWAN is Green, WLAN is Yellow)	
D8	SATA/mSATA (blue) activity	
D9	Power good (green) and fault indicator (yellow) dual-LED	
D10	Link activity (green) for Ethernet port 0	
D11	Link activity (green) for Ethernet port 1	
D12	Wireless WAN/LAN activity for module installed in Mini PCIe Socket #1 (WWAN is Green, WLAN is Yellow)	
LED	Status Indication	Position

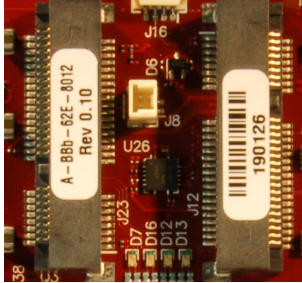

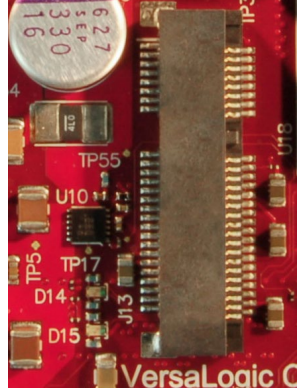
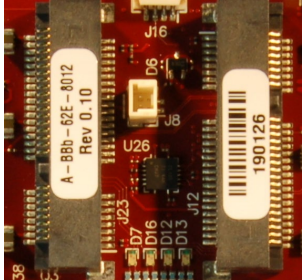
D13	Status of power and wireless PAN activity for module installed in Mini PCIe Socket #1 (Power Status is yellow, wireless PAN activity is green)	
D14	Wireless WAN/LAN activity for module installed in Mini PCIe Socket #2 (WWAN is Green, WLAN is Yellow)	
D15	Status of power and wireless PAN activity for module installed in Mini PCIe Socket #2 (Power Status is yellow, wireless PAN activity is green)	
D16	Status of power and wireless PAN activity for module installed in Mini PCIe Socket #3 (Power Status is yellow, wireless PAN activity is green)	

### **Power-Good/Fault Indicator LEDs**

A dual-color (green/yellow) LED (D9) provides the following status:

- Green – indicates power good when the Blackbird in an S0 state. When in sleep modes, the LED pulses every 2 seconds.
- Yellow – indicates a fault. If this LED remains lit after power-cycling the Blackbird, contact VersaLogic Customer Support.

## Mass Storage Interfaces

### SATA Interface

The Blackbird provides three serial ATA 3.0 (SATA 3.0) ports that communicate at a rate of up to 6.0 Gbits/s. Two ports connect to right-angle SATA connectors with latching capability. The third port connects to Minicard #1 when an mSATA module is installed.

The ATX power supplies Power to the SATA drive. Note that the standard SATA drive power connector is different from the common 4-pin Molex connector used on IDE drives. Most current ATX power supplies provide SATA connectors, and many SATA drives provide both types of power connectors. If the power supply you are using does not provide SATA connectors, adapters are available.

Figure 12. Location of the SATA Connectors

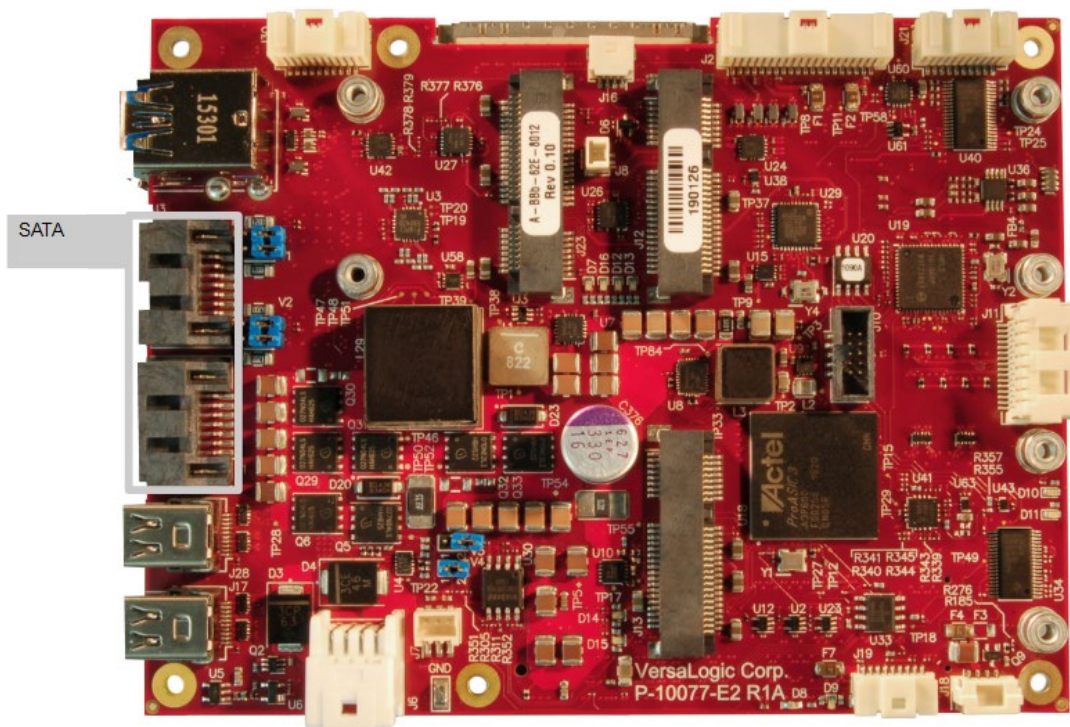



**Table 6. SATA Port Configuration**

COM Port	Port Speed	Destination
0	SATA 3.0	On-board SATA right-angle latching connector J1 (VL P/N <b>XE1SATASA</b> )
1	SATA 3.0	On-board SATA right-angle latching connector J3 (VL P/N <b>XE1SATASA</b> )
2	SATA 3.0	Electronically mux'd to the minicard #1 when selected for mSATA mode (otherwise this port is not used).

## Multi-purpose I/O

### USB Interfaces

As shown below, the Blackbird supports four USB 2.0 Host ports and two USB 3.0 Super-Speed ports.

**Figure 13. Location of the USB Ports**

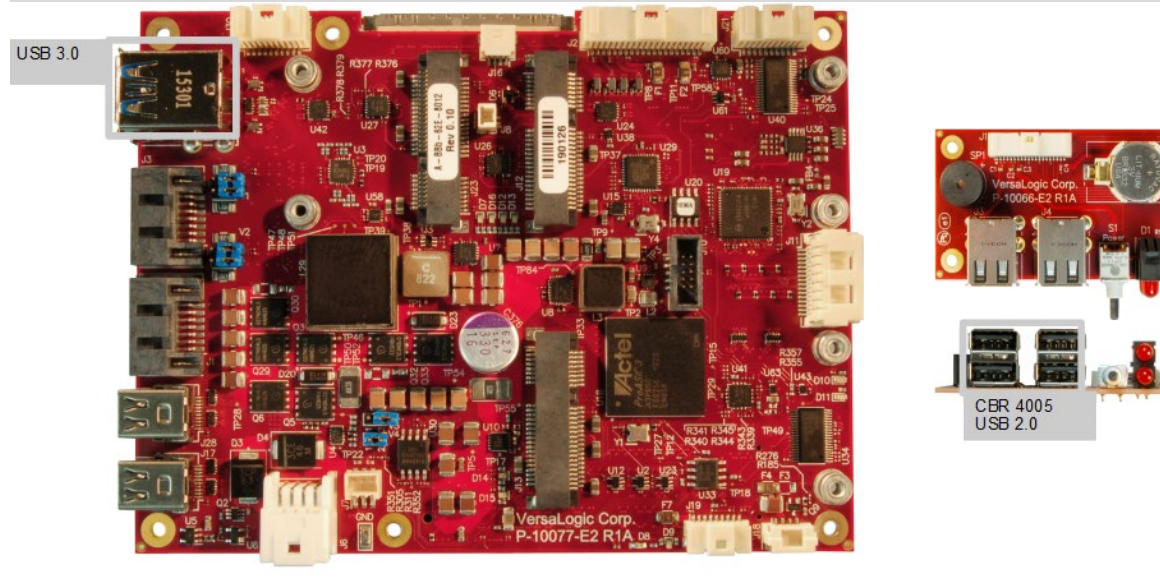

## Mini PCIe Sockets

The figure below shows the location of the three Mini PCIe sockets. All three minicards support USB and SMBus interfaces. Minicard 1 is full-size and supports either a PCIe Minicard or an mSATA module. Minicard 2 is also full-size and supports PCIe. Minicard 3 is half-size and supports PCIe. For information on Mini PCIe modules available from VersaLogic, contact [Sales@VersaLogic.com](mailto:Sales@VersaLogic.com).

The VL-MPEs-F1E series of mSATA modules provide flash storage of 4 GB, 16 GB, or 32 GB.

To secure a Mini PCIe card or mSATA module to the on-board standoffs, use two M2.5 x 6 mm pan head Philips nylon screws. These screws are available in quantities of 10 in the VL-HDW-108 hardware kit from VersaLogic.

**Figure 14. Location of Mini PCIe Sockets**

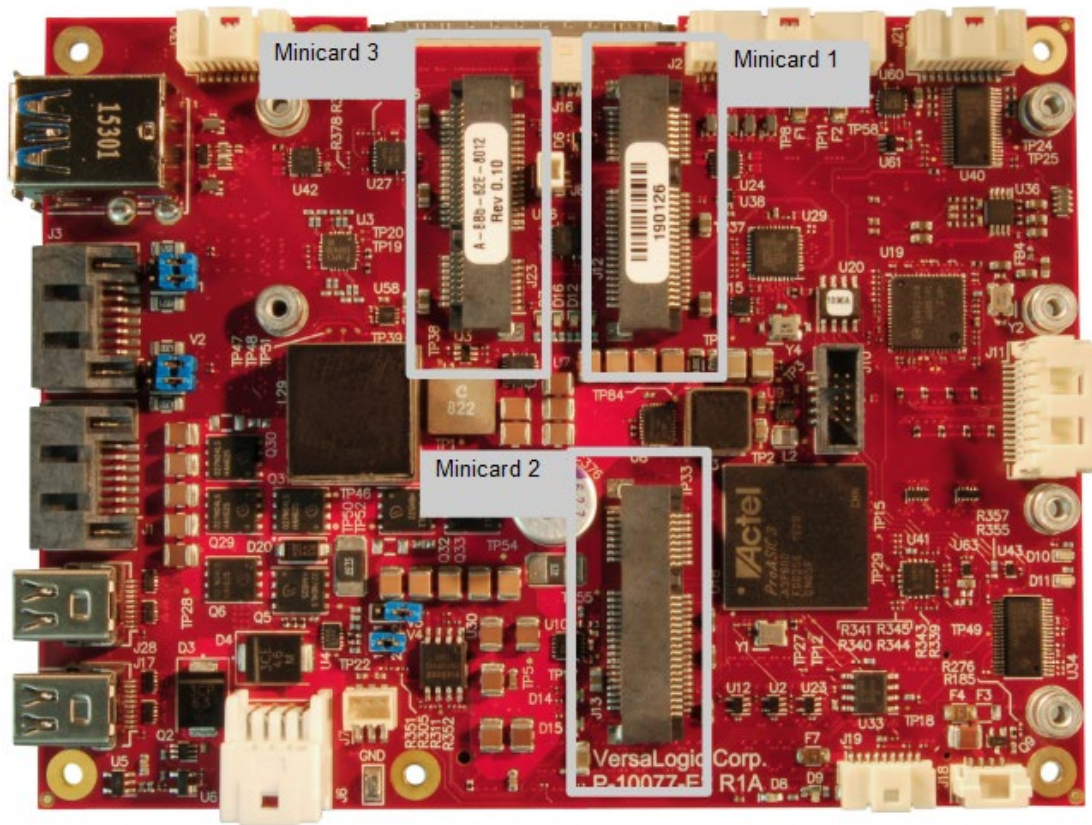

Table 7: Mini PCIe / mSATA Socket Pinout

Pin	Mini PCIe Signal Name	Mini PCIe Function	mSATA Signal Name	mSATA Function
1	WAKE#	Wake	Reserved	Not connected
2	3.3VAUX	3.3 V auxiliary source	+3.3V	3.3 V source
3	NC	Not connected	Reserved	Not connected
4	GND	Ground	GND	Ground
5	NC	Not connected	Reserved	Not connected
6	1.5V	1.5 V power	+1.5V	1.5 V power
7	CLKREQ#	Reference clock request	Reserved	Not connected
8	NC	Not connected	Reserved	Not connected
9	GND	Ground	GND	Ground
10	NC	Not connected	Reserved	Not connected
11	REFCLK-	Reference clock input –	Reserved	Not connected
12	NC	Not connected	Reserved	Not connected
13	REFCLK+	Reference clock input +	Reserved	Not connected
14	NC	Not connected	Reserved	Not connected
15	GND	Ground	GND	Ground
16	NC	Not connected	Reserved	Not connected
17	NC	Not connected	Reserved	Not connected
18	GND	Ground	GND	Ground
19	NC	Not connected	Reserved	Not connected
20	W_DISABLE#	Wireless disable	Reserved	Not connected
21	GND	Ground	GND	Ground
22	PERST#	Card reset	Reserved	Not connected
23	PERn0	PCIe receive –	+B	Host receiver diff. pair +
24	3.3VAUX	3.3 V auxiliary source	+3.3V	3.3 V source
25	PERp0	PCIe receive +	-B	Host receiver diff. pair –
26	GND	Ground	GND	Ground
27	GND	Ground	GND	Ground
28	1.5V	1.5 V power	+1.5V	1.5 V power
29	GND	Ground	GND	Ground
30	SMB_CLK	SMBus clock	Two Wire I/F	Two wire I/F clock
31	PETn0	PCIe transmit –	-A	Host transmitter diff. pair –
32	SMB_DATA	SMBus data	Two Wire I/F	Two wire I/F data
33	PETp0	PCIe transmit +	+A	Host transmitter diff. pair +
34	GND	Ground	GND	Ground
35	GND	Ground	GND	Ground

Pin	Mini PCIe Signal Name	Mini PCIe Function		mSATA Signal Name	mSATA Function
36	USB_D-	USB data –		Reserved	Not connected
37	GND	Ground		GND	Ground
38	USB_D+	USB data +		Reserved	Not connected
39	3.3VAUX	3.3V auxiliary source		+3.3V	3.3 V source
40	GND	Ground		GND	Ground
41	3.3VAUX	3.3 V auxiliary source		+3.3V	3.3 V source
42	LED_WWAN#	Wireless WAN LED		Reserved	Not connected
43	GND	mSATA Detect ( <b>Note 1</b> )		GND/NC	Ground/Not connected
44	LED_WLAN#	Wireless LAN LED		Reserved	Not connected
45	NC	Not connected		Vendor	Not connected
46	LED_WPAN#	Wireless PAN LED		Reserved	Not connected
47	NC	Not connected		Vendor	Not connected
48	1.5V	1.5 V power		+1.5V	1.5 V power
49	Reserved	Reserved		DA/DSS	Device activity
50	GND	Ground		GND	Ground
51	Reserved	Reserved		GND	Ground ( <b>Note 2</b> )
52	3.3VAUX	3.3 V auxiliary source		+3.3V	3.3 V source

**Notes:**

1. Some mSATA modules do not leave Pin 43 open.
2. Some Mini PCIe cards use this signal as a second Mini PCIe card wireless disable input. On the Blackbird, this signal is available for use for mSATA versus Mini PCIe card detection. There is an option on the VersaLogic Features BIOS Setup utility screen for setting the mSATA detection method.

**W\_DISABLE# Signal**

The W\_DISABLE# signal is for use with optional wireless Ethernet Mini PCIe cards. The signal enables you to disable a wireless card's radio operation in order to meet public safety regulations or when otherwise desired. W\_DISABLE# is an active low signal that when driven low (shorted to ground) disables radio operation on the Mini PCIe card wireless device. When W\_DISABLE# is not asserted, or in a high impedance state, the radio may transmit if not disabled by other means such as software. The W\_DISABLE# signals for each of the three Minicards are controlled by registers in the FPGA.

## Mini PCIe Card Status LEDs

These LEDs provide status for modules installed in the Mini PCIe sockets. The table below lists the states of the LEDs. The Power On LED is an important warning to not hot-plug the minicard. It is intentionally yellow to indicate “caution”. Figure 15 shows their location on the Blackbird.

**Table 8: Mini PCIe Card Status LEDs**

LED	Ref Des	State	Description
Green (WWAN)	D12 (#1)	On	WWAN active
	D14 (#2)	Off	WWAN inactive
	D7 (#3)		
Yellow (WLAN)	D12 (#1)	On	WLAN active
	D14 (#2)	Off	WLAN inactive
	D7 (#3)		
Green (WPAN)	D13 (#1)	On	WPAN active
	D15 (#2)	Off	WPAN inactive
	D16 (#3)		
Yellow (Power On)	D13 (#1)	On	Minicard Power is On
	D15 (#2)	Off	Minicard Power is Off
	D16 (#3)		

**Figure 15. Mini PCIe Status LEDs**

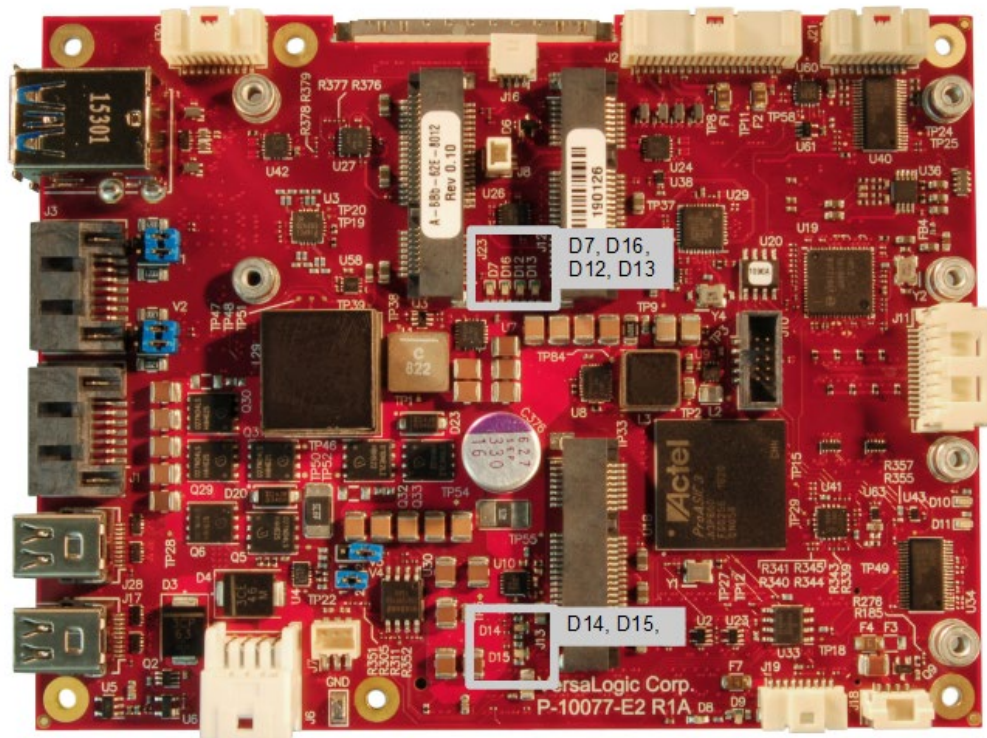



## User I/O Connector

The 40-pin user I/O connector incorporates the signals for the following:

- Four USB ports
- Eight GPIO lines (these are functionally muxed with six timer I/O signals per FPGA registers). There are eight timer signals and they share digital I/Os 16-9. The eight GPIO lines on the paddleboard each have an alternate mode, accessible using the FPGA's AUXMODE1 register. Refer to the *EPU-4562/4462 Programmer's Reference Manual* for more information on FPGA registers.
- Three LEDs (two Ethernet link status LEDs and a programmable LED)
- Two I<sup>2</sup>C signals (clock and data)
- Push-button power switch
- Push-button reset switch
- Speaker output

This connector uses IEC 61000-4-2-rated TVS components to help protect against ESD damage.

The following figure shows the location and pin orientation of the user I/O connector.

**Figure 16. Location and Pin Orientation of the User I/O Connector**

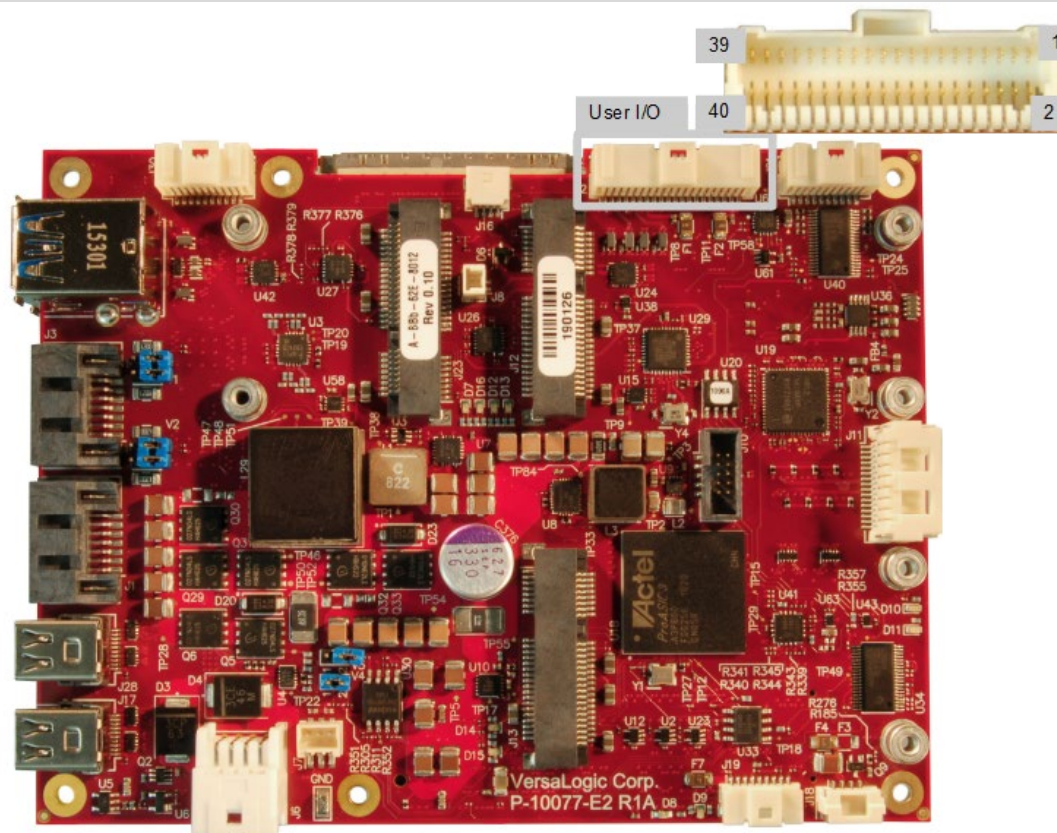

The following table provides the pinout of the user I/O connector.

**Table 9: User I/O Connector Pinout and Pin Orientation**

Pin	Signal	Pin	Signal
1	+5 V (Note 1)	2	GND
3	USB1_P	4	USB2_P
5	USB1_N	6	USB2_N
7	+5V (Note 2)	8	GND
9	USB3_P	10	USB4_P
11	USB3_N	12	USB4_N
13	+3.3 V (Note 3)	14	GND
15	SPKR#	16	PLED#
17	PWR_BTN#	18	RST_BTN#
19	GND	20	GND
21	I2C Clock (Note 4)	22	V_BATT
23	I2C Data	24	V_BATT Return
25	GND	26	GND
27	GPIO1	28	GPIO2
29	GPIO3	30	GPIO4
31	GND	32	GND
33	GPIO5	34	GPIO6
35	GPIO7	36	GPIO8
37	+3.3 V (Note 5)	38	GND
39	ETH LED0	40	ETH LED1

**Notes:**

1. This is the +5V VBUS power for USB Port 1 and 2.
2. This is the +5V VBUS power for USB Port 3 and 4.
3. This 3.3 V power goes off in sleep modes. The SPKR# uses this power as should the PLED# (there is no requirement for PLED# to use this power, but the VL-CBR-4005B paddleboard does).
4. There are 10k pullups on the I2C clock & data signals.
5. This 3.3 V power can be turned on or off similar to the 3.3V power to the Mini Card via the FPGA (can go off in sleep modes or always stay on; by default it goes off in sleep modes). It is used for the 10 k $\Omega$  pullup resistor power on the 8x GPIOs and usually for the 2x Ethernet LEDs, however, the Ethernet LEDs can be powered by a 3.3 V power source.

## Cabling

An adapter cable, part number VL-CBR-4005A, is available for connecting the CBR-4005B paddleboard to the VL-EPU-4562/4462. This is a 12-inch, Pico-Clasp 40-pin to 40-pin cable.

If your application requires a custom cable, the following information will be useful:

EPU-4562/4462 Board Connector	Mating Connector
Molex 501571-4007	Molex 501189-4010



## Analog-to-Digital and Digital to Analog Converter Interface

The Analog-to-Digital and Digital to Analog converter interface provides eight single-ended analog input channels. The figure below shows the location and pin orientation of the Analog-to-Digital and Digital to Analog connector.

The 20-pin I/O connector (J30) incorporates 16 Digital I/O (DIO) lines that are independently configurable as an input or output. DIO inputs can be set for normal or inverted level. DIO outputs can be set to be normal HIGH or LOW state. There are pull-up resistors to +3.3 V on all DIO lines. The pull-ups implemented — in the FPGA — can range in value from 20 k $\Omega$  to 40 k $\Omega$ . After reset, the DIO lines are set as inputs with pull-ups that will be detected as a HIGH state to external equipment.

VersaLogic provides a set of application programming interface (API) calls for managing the DIO lines. See the VersaAPI Support Page for information

**Figure 17. Location and Pin Orientation of the Analog-to-Digital Input Connector**

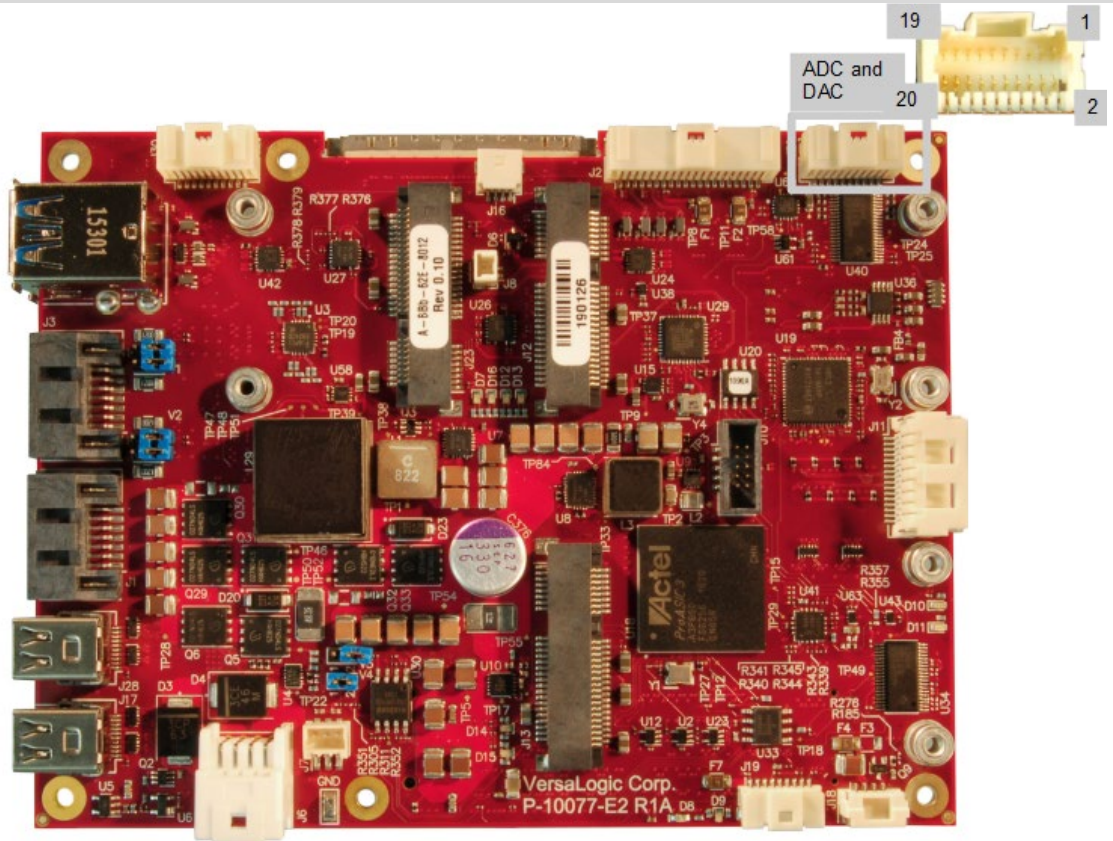

The EPU-4562/4462 uses a Texas Instruments ADS8668 eight-channel 12-bit A/D converter. The converter has a 500 kilo-samples-per-second (ksps) aggregate sampling rate, with a 1.115  $\mu$ s acquisition time, high-impedance. The converter is per-channel programmable for the following input ranges:

- $\pm 0.64$  V
- $\pm 1.28$  V
- $\pm 2.56$  V
- $\pm 5.12$  V
- $\pm 10.24$  V
- 0 to 1.28 V
- 0 to 2.56 V
- 0 to 5.12 V
- 0 to 10.24 V

Communications with the A/D converter are handled by the FPGA, which uses the SPX slave selection signal for SPI device 5 to enable the A/D read strobe for the SPI interface. Refer to the *VL-EPU-4562/4462 Programmer's Reference Manual* (available on the EPU-4562/4462 Product Support Web Page) for information on configuring the SPX registers for A/D access.

Refer to the [Texas Instruments ADS8668 A/D Converter Datasheet](#) for programming information.

This table provides the pinout of the Analog-to-Digital and Digital to Analog Input connector.

**Table 10: Analog-to-Digital and Digital to Analog Input Connector Pinout**

Pin	Signal	Pin	Signal
1	Analog Input 1	2	Analog Input 2
3	Analog Ground	4	Analog Ground
5	Analog Input 3	6	Analog Input 4
7	Analog Ground	8	Analog Ground
9	Analog Input 5	10	Analog Input 6
11	Analog Ground	12	Analog Ground
13	Analog Input 7	14	Analog Input 8
15	Analog Ground	16	Analog Ground
17	Analog Output #1	18	Analog Output #2
19	Analog Output #3	20	Analog Output #4

### Cabling

The VL-CBR-2004 paddleboard is bundled with an adapter cable for connecting the Blackbird to the VL-CBR-2004 paddleboard. This is a 12-inch, Pico-Clasp 20-pin to 20-pin cable.

If your application requires a custom cable, the following information will be useful:

EPU-4562/4462 Board Connector	Mating Connector
Molex 501571-2007	Molex 501189-2010

## SPX™ Expansion Bus

Up to two serial peripheral expansion (SPX) devices can be attached to the Blackbird at connector using a CBR-0901 cable. The SPX interface provides the standard serial peripheral interface (SPI) signals: CLK, MISO, and MOSI, as well as two chip selects, SS0# and SS1#. The +5 V power provided to pin 1 of the SPX connector is protected by a 1 A resettable fuse.

The figure below shows the location and pin orientation of the SPX connector.

**Figure 18. SPX Connector Location and Pin Configuration**

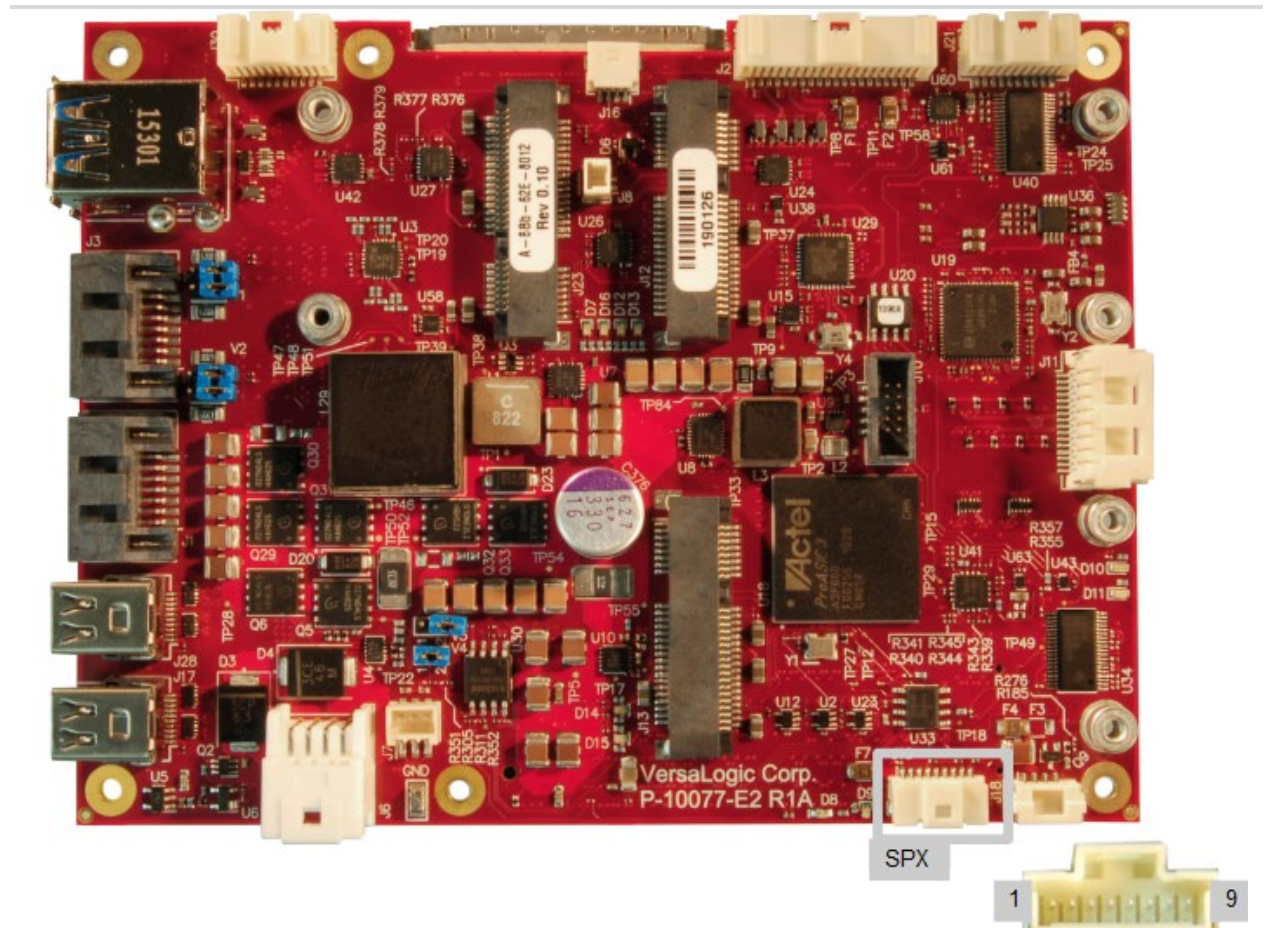

The table below lists the pinout of the SPX connector.

**Table 11: SPX Connector Pinout**

Pin	Signal	Function
1	VCC	+5.0 V ( <b>Note</b> )
2	CLK	SPX Clock
3	GND	Ground
4	MISO	Master input, Slave output
5	GND	Ground
6	MOSI	Master output, Slave input
7	GND	Ground
8	SS0#	Chip Select 0
9	SS1#	Chip Select 1

**Note.** This power is off in sleep mode

SPI is, in its simplest form, a three wire serial bus. One signal is a clock, driven only by the permanent master device on-board. The others are Data In and Data Out with respect to the master. The SPX implementation on the Blackbird supports chip selects. The master device initiates all SPI transactions. A slave device responds when its chip select is asserted and it receives clock pulses from the master. All four common SPI modes are supported through the use of clock polarity and clock idle state controls.

## Cabling

An adapter cable, part number CBR-0901, is available. This is a 9-inch, 9-pin Pico-Clasp to Dual SPX cable.

If your application requires a custom cable, the following information will be useful:

EPU-4562/4462 Board Connector	Mating Connector
Molex 501568-0907	Molex 501330-0900



## Serial Ports

The Blackbird provides four serial ports. All ports can operate in either RS-232, RS-422, or RS-485 mode. IRQ interrupts are chosen in the BIOS Setup utility. The UARTs are 16550-based serial ports implemented in the FPGA.

The figure below shows the location and pin orientation of the two serial I/O connectors.

**Figure 19. Location and Pin Orientation of the Serial I/O Connectors**

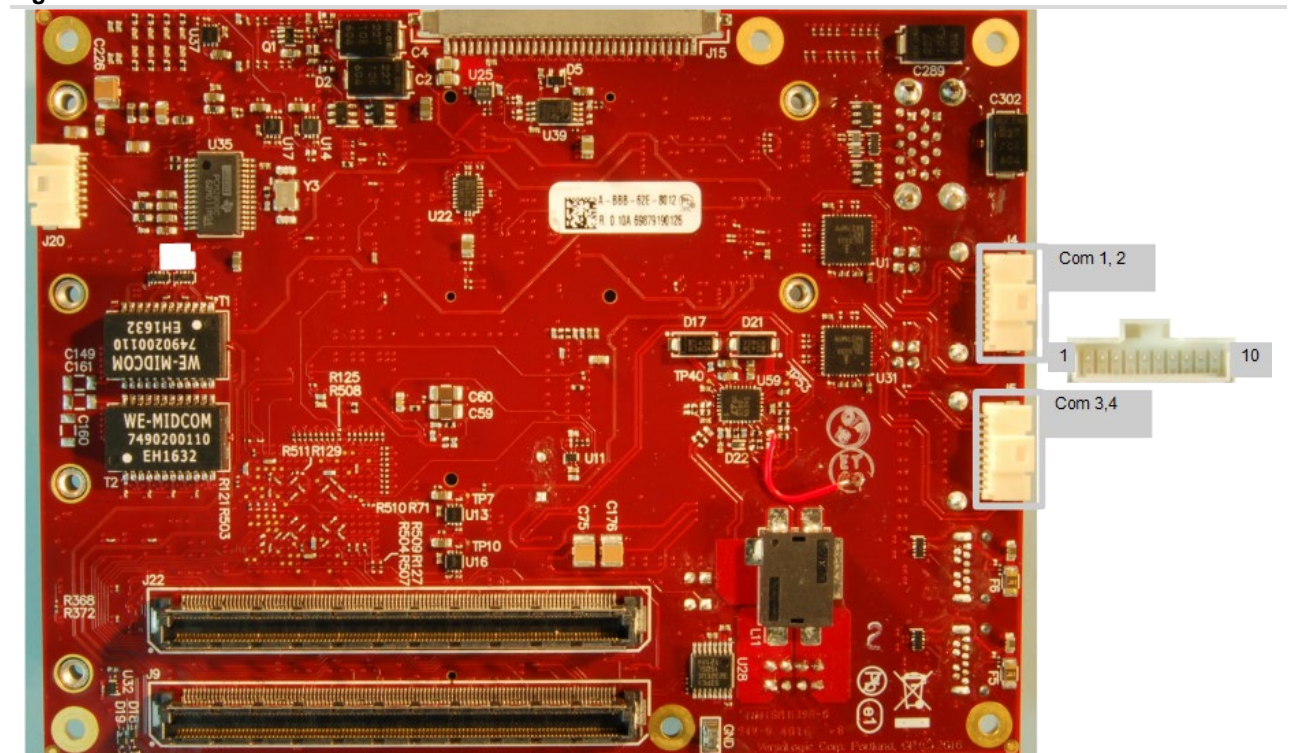

## Serial Port Connector Pinout

Table 12: COM1/COM2 Connector Pinout

Pin	RS-232 Signal	RS-422/RS-485 Signal	Port
1	RTS1	TXD1_P	COM1
2	TXD1#	TXD1_N	
3	CTS1	RXD1_P	
4	RXD1#	RXD1_N	
5	GND	GND	—
6	RTS2	TXD2_P	COM2
7	TXD2#	TXD2_N	
8	CTS2	RXD2_P	
9	RXD2#	RXD2_N	
10	GND	GND	—

Table 13: COM3/COM4 Connector Pinout

Pin	RS-232 Signal	RS-422/RS-485 Signal	Port
1	RTS3	TXD3_P	COM3
2	TXD3#	TXD3_N	
3	CTS3	RXD3_P	
4	RXD3#	RXD3_N	
5	GND	GND	—
6	RTS4	TXD4_P	COM4
7	TXD4	TXD4_N	
8	CTS4	RXD4_P	
9	RXD4#	RXD4_N	
10	GND	GND	—

### Cabling

An adapter cable, part number CBR-1014, is available for routing the serial I/O signals to 9-pin D-sub connectors. This is a 12-inch, Pico-Clasp 10-pin to two 9-pin D-sub connector cable.

If your application requires a custom cable, the following information will be useful:

<b>EPU-4562/4462 Board Connector</b>	<b>Mating Connector</b>
Molex 501331-1007	Molex 501330-1000

### **COM Port Configuration**

Jumper blocks V1 and V2 configure the serial ports for RS-232 or RS-485/RS-422 operation. See the section titled “Jumper Blocks” on page 17 for details. The termination resistor should only be enabled for RS-485 or RS-422 endpoint stations and not for intermediate stations. Termination must not be used for RS-232.

## **Console Redirection**

The Blackbird can be configured for remote access by redirecting the console to a serial communications port. The BIOS Setup utility and some operating systems (such as MS-DOS) can use this console for user interaction. The default settings for the redirected console are as follows:

- 115,200 baud rate
- 8 data bits, No parity, 1 stop bit (that is, 8-None-1)
- No flow control

---

# Audio and Video Interfaces

---



The Intel Core processor series contains an integrated graphics engine with advanced 2D/3D graphics, video decode and encode capabilities, and a display controller. The Blackbird provides the following video interfaces:

- Two Mini DisplayPort++ connectors
- One LVDS display connector; a 4-pin LVDS backlight control connector is also provided

## Mini DisplayPort++ (DP++) Connectors

DisplayPort consists of three interfaces:

- Main Link – transfers high-speed isochronous video and audio data
- Auxiliary channel – used for link management and device control; the EDID is read over this interface
- Hot Plug Detect – indicates that a cable is plugged in

The DisplayPort interface supports:

- Audio signaling
- DP++ mode allowing connection to an HDMI device through a passive adapter. “Passive” means that the adapter does not do any protocol conversion from DP to HDMI (the upstream processor switches to HDMI mode after it detects the adapter) and as a result it does not require software drivers.

The next figure shows the location of the 20-pin Mini DisplayPort++ connector. Table 14 lists the pinout of these Mini DisplayPort++ connectors.



Figure 20. Location of the Mini DisplayPort++ Connector

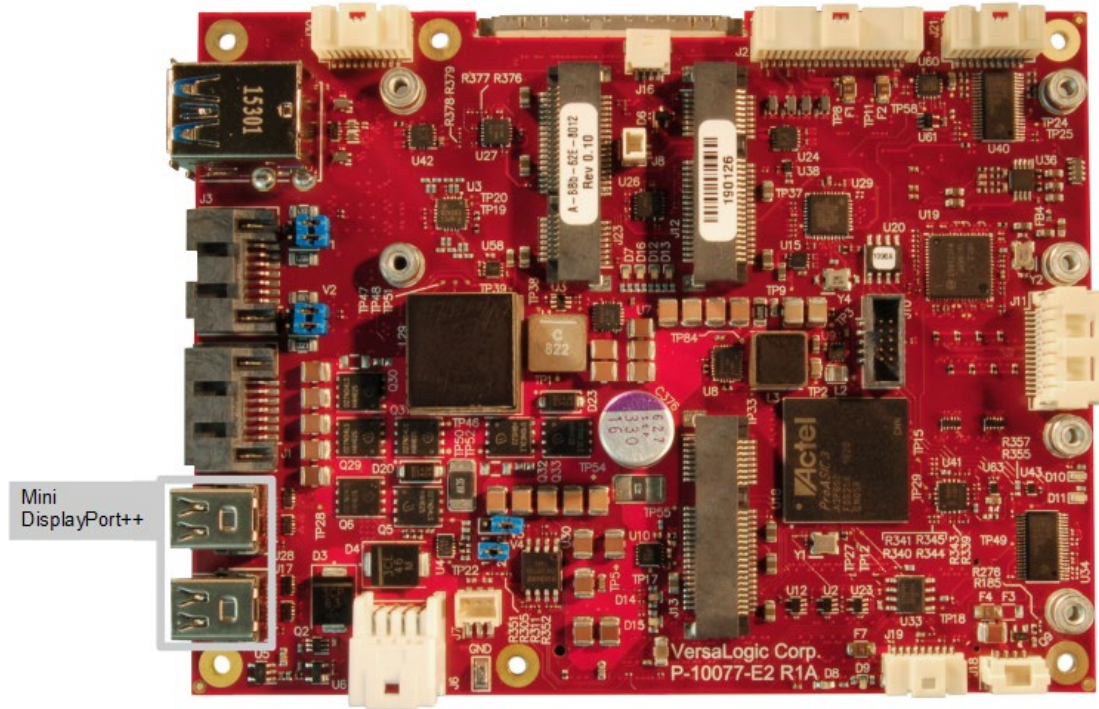

Table 14: Mini DisplayPort++ Connector Pinout

Pin	Signal	Pin	Signal
1	GND	2	HOT PLUG DETECT
3	ML_LANE0_P	4	CONFIG 1
5	ML_LANE0_N	6	CONFIG 2
7	GND	8	GND
9	ML_LANE1_P	10	ML_LANE3_P
11	ML_LANE1_N	12	ML_LANE3_N
13	GND	14	GND
15	ML_LANE2_P	16	AUX_CH_P
17	ML_LANE2_N	18	AUX_CH_N
19	GND	20	DP_POWER (3.3V) <b>Note</b>

**Note:** Power is off in sleep modes and the maximum current is 500mA and has a 1A resettable fuse.

## VGA Output

A VGA monitor can be attached to either Mini DisplayPort++ connector using the VL-CBR-2032 Mini DisplayPort-to-VGA adapter, similar to the one below.

**Figure 21. VL-CBR-2032 Mini DisplayPort to VGA Adapter**



## Audio Output

An audio connector is located on the bottom of the board at J20. Use the VersaLogic audio cable VL-CBR-0810 for output.

**Note:** Systems running Windows will need the appropriate drivers installed.

**Table 15. Audio Connector Pinout (J20)**

Pin	Signal
1	AUD_LIN
2	AGND_AUD
3	AUD_RIN
4	AGND_AUD
5	AUD_LOUT
6	AGND_AUD
7	AUD_ROUT
8	GND

## LVDS Interface

### LVDS Flat Panel Display Connector

The integrated LVDS flat panel display in the Blackbird is an ANSI/TIA/EIA-644-1995 specification-compliant interface. It can support 18 or 24 bits of RGB pixel data plus 3 bits of timing control (HSYNC/VSYNC/DE) on the 4 differential data output pairs. The LVDS interface supports a maximum resolution of 1920x1080 (60 Hz). The figure below shows the location of the LVDS display connector as well as the location and pin orientation of the LVDS back light connector.

The BIOS Setup utility provides several options for standard LVDS flat panel types. If these options do not match the requirements of the panel you are using, contact [Support@VersaLogic.com](mailto:Support@VersaLogic.com) for a custom video BIOS.

**Figure 22. Location of the LVDS Connectors**

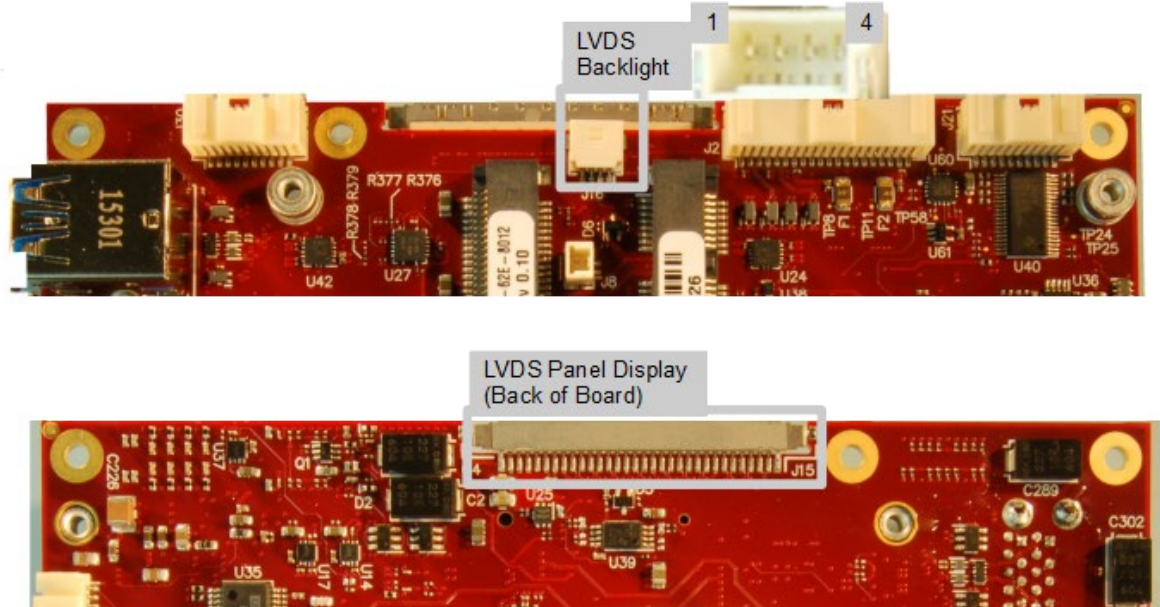

**Table 16: LVDS Flat Panel Display Connector Pinout**

Pin	Signal Name	Function
1	GD1	Guard (tie to Earth Ground).
2	LVDS_ODD0_N	LVDS Odd Lane 0 Neg Diff Signal
3	LVDS_ODD0_P	LVDS Odd Lane 0 Pos Diff Signal
4	LVDS_ODD1_N	LVDS Odd Lane 1 Neg Diff Signal
5	LVDS_ODD1_P	LVDS Odd Lane 1 Pos Diff Signal
6	LVDS_ODD2_N	LVDS Odd Lane 2 Neg Diff Signal
7	LVDS_ODD2_P	LVDS Odd Lane 2 Pos Diff Signal
8	GND1	Signal/Power Ground
9	LVDS_ODDCLK_N	LVDS Odd Clock Neg Diff Signal
10	LVDS_ODDCLK_P	LVDS Odd Clock Pos Diff Signal
11	LVDS_ODD3_N	LVDS Odd Lane 3 Neg Diff Signal
12	LVDS_ODD3_P	LVDS Odd Lane 3 Pos Diff Signal
13	LVDS_EVEN0_N	LVDS Even Lane 0 Neg Diff Signal

Pin	Signal Name	Function
14	LVDS_EVEN0_P	LVDS Even Lane 0 Pos Diff Signal
15	GND2	Signal/Power Ground
16	LVDS_EVEN1_N	LVDS Even Lane 1 Neg Diff Signal
17	LVDS_EVEN1_P	LVDS Even Lane 1 Pos Diff Signal
18	GND3	Signal/Power Ground
19	LVDS_EVEN2_N	LVDS Even Lane 2 Neg Diff Signal
20	LVDS_EVEN2_P	LVDS Even Lane 2 Pos Diff Signal
21	LVDS_EVENCLK_N	LVDS Even Clock Neg Diff Signal
22	LVDS_EVENCLK_P	LVDS Even Clock Pos Diff Signal
23	LVDS_EVEN3_N	LVDS Even Lane 3 Neg Diff Signal
24	LVDS_EVEN3_P	LVDS Even Lane 3 Pos Diff Signal
25	GND4	Signal/Power Ground
26	GND5	Signal/Power Ground
27	VCC1	Panel Power (3.3V) <b>Note</b>
28	GND6	Signal/Power Ground
29	VCC2	Panel Power (3.3V)
30	VCC3	Panel Power (3.3V)
31	VCC4	Panel Power (3.3V)
32	GD2	Guard (tie to Earth Ground).
33	MP1	Mounting pad on Pin1 end connected to Guard pins (tie to Earth Ground).
34	MP2	Mounting pad on Pin 32 end connected to Guard pins (tie to Earth Ground).

**Note:** Panel power goes off in sleep modes.

The +3.3V power provided to pins 19 and 20 is protected by a software-controllable power switch (1 Amp max.). The LVDD\_EN signal controls this switch from the LVDS interface controller in the CPU.

### Cabling

The following LVDS cables are available for use with the Blackbird board:

VL-CBR-3001 – 20” 2-Ch LVDS 30-pin JAE to 30-pin JAE (FI-X30HL)

VL-CBR-3002 – 20” 1-Ch LVDS 30-pin JAE to 1.25mm 20-pin Hirose (DF14-20S-1.25C)

VL-CBR-3003 – 20” 1-Ch LVDS 30-pin JAE to 20-pin JAE (F1-S20S)

If your application requires a custom cable, the following information will be useful:

EPU-4562/4462 Board Connector	Mating Connector
<ul style="list-style-type: none"> <li>Hirose MDF76GW-30S-1H(55)</li> <li>JAE FI-X30SSLA-HF</li> </ul>	<ul style="list-style-type: none"> <li>Hirose MDF76-30P-1C</li> <li>JAE FI-X30HL</li> </ul>

## LVDS Backlight Connector

Figure 22 shows the location and pin orientation of the LVDS back light connector. The table below lists the pinout of the LVDS backlight connector.

**Table 17: LVDS Backlight Connector Pinout**

Pin	Signal Name	Function
1	LVDS_BKLT_EN	LVDS backlight enable output. (5V TTL-level signal by default but will operate at higher voltages if the LVDS_BKLT_PWR is provided). High = enabled, Low = disabled.
2	Signal Ground	Ground
3	LVDS_BKLT_CTRL	LVDS backlight control output. (5V TTL-level signal by default but will operate at higher voltages if the LVDS_BKLT_PWR is provided). This is a PWM signal and the duty cycle can be set in the BIOS Setup utility.
4	LVDS_BKLT_LOGIC_PWR	Optional backlight logic power input. (Can range from +5V to +14V and sets the high-value on the LVDS_BKLT_EN and LVDS_BKLT_CTRL signals.) On-board +5V power is used when this is not connected.

### Cabling

An adapter cable, part number CBR-0404, is available for powering the LVDS backlight from the Blackbird board.

If your application requires a custom cable, the following information will be useful:

EPU-4562/4462 Board Connector	Mating Connector
Molex 501568-0407	Molex 501330-0400



## Network Interfaces

The Blackbird provides two Gigabit Ethernet interfaces with one from an Intel I210-IT Gigabit Ethernet controller on the baseboard and the second from an Intel I219-LM Gigabit Phy on the COM Express module (connected to the internal MAC in the Skylake processor). They both provide a standard IEEE 802.3 Ethernet interface for 1000Base-T, 100Base-TX, and 10Base-T applications. Both auto-negotiate connection speed. Drivers are readily available to support a variety of operating systems. For more information on these devices, refer to [Intel I210 Ethernet Controller datasheet](#) or [Intel I219 Ethernet Controller datasheet](#).

**✂ Integrator's Note:** Ethernet Port 1 supports network boot; Port 0 does not.

### Ethernet Connector

The Ethernet connector provides access to the Ethernet ports 0 and 1. Ethernet Port 0 connects to the I210-IT Ethernet controller on the baseboard and Ethernet Port 1 connects to the I219-LM Ethernet Phy on the COM Express module. The connector uses IEC 61000-4-2-rated TVS components to help protect against ESD damage. The figure below shows the location and pin orientation of the Ethernet connector.

**Figure 23. Location and Pin Orientation of the Ethernet Connector**

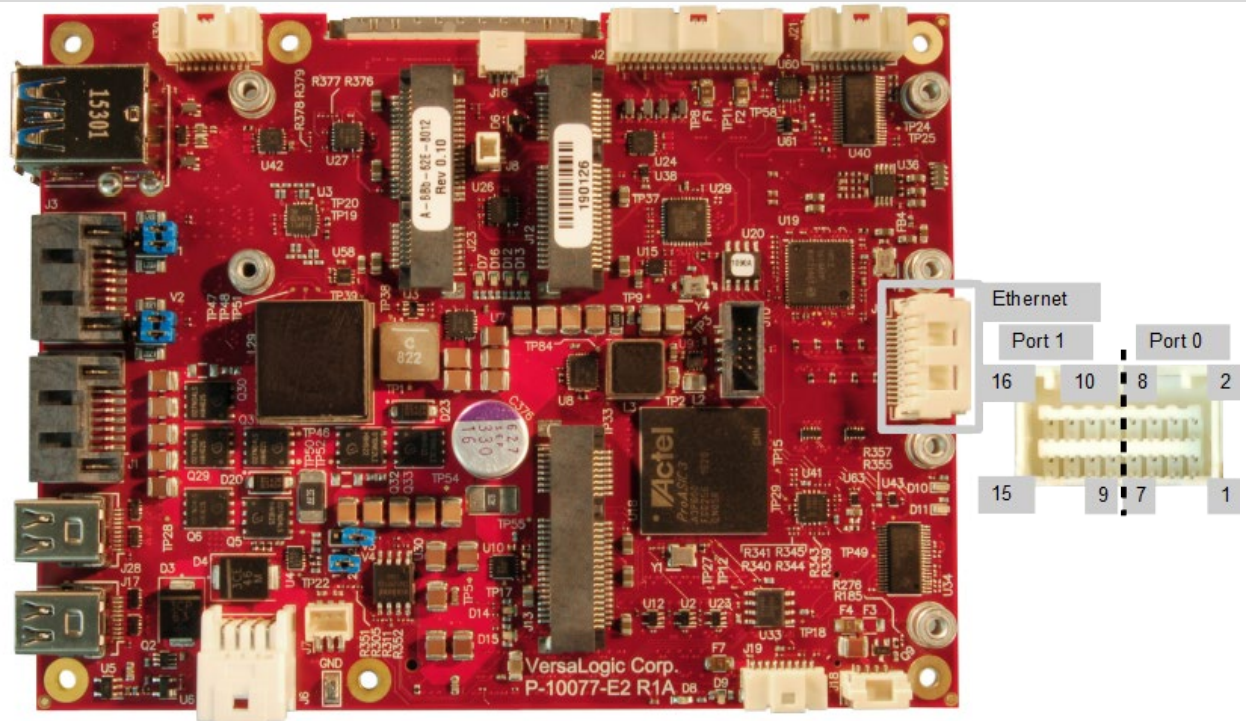

The following table lists the pinout of the Ethernet connector.

**Table 18: Ethernet Connector Pinout**

	Pin	10/100 Signals	10/100/1000 Signals	Pin	10/100 Signals	10/100/1000 Signals	
Port 0	1	- Auto Switch (Tx or Rx)	BI_DD-	2	+ Auto Switch (Tx or Rx)	BI_DD+	Port 0
	3	- Auto Switch (Tx or Rx)	BI_DB-	4	+ Auto Switch (Tx or Rx)	BI_DB+	
	5	- Auto Switch (Tx or Rx)	BI_DC-	6	+ Auto Switch (Tx or Rx)	BI_DC+	
	7	- Auto Switch (Tx or Rx)	BI_DA-	8	+ Auto Switch (Tx or Rx)	BI_DA+	
Port 1	9	- Auto Switch (Tx or Rx)	BI_DD-	10	+ Auto Switch (Tx or Rx)	BI_DD+	Port 1
	11	- Auto Switch (Tx or Rx)	BI_DB-	12	+ Auto Switch (Tx or Rx)	BI_DB+	
	13	- Auto Switch (Tx or Rx)	BI_DC-	14	+ Auto Switch (Tx or Rx)	BI_DC+	
	15	- Auto Switch (Tx or Rx)	BI_DA-	16	+ Auto Switch (Tx or Rx)	BI_DA+	

### Cabling

An adapter cable, part number CBR-1604, is available. This is a 12-inch, 16-pin Click-Mate to two RJ-45 connector cables.

If your application requires a custom cable, the following information will be useful:

EPU-4562/4462 Board Connector	Mating Connector
Molex 503148-1690	Molex 503149-1600

## Ethernet Status LEDs

The figure below shows the location of the Ethernet status LED.

**Table 19. Ethernet Status LED Details**

LED	Ref Des	State	Description
Green (Activity)	<b>D10 (Eth 0)</b>	On	Link Good (pulses with activity)
	<b>D11 (Eth 1)</b>	Off	Link is not good or cable is not connected

**Figure 24. Onboard Ethernet Status LEDs**

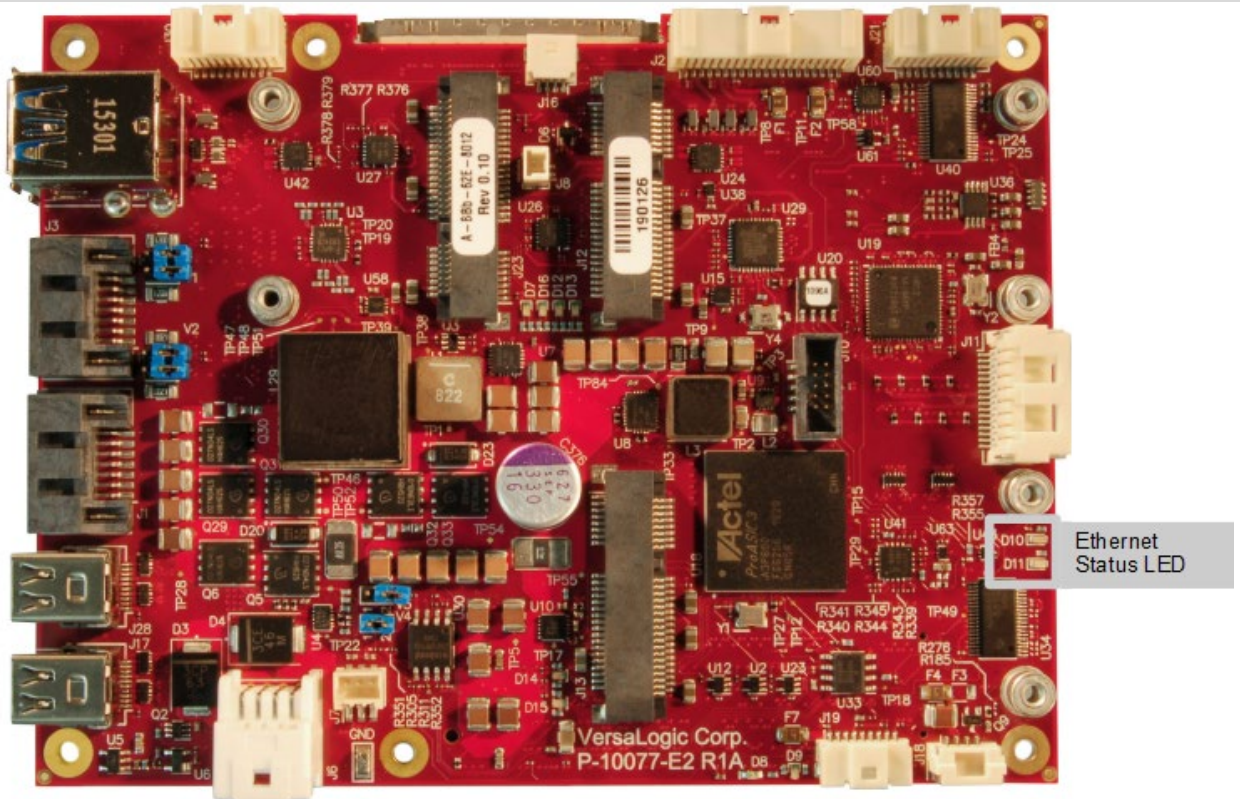



## VL-CBR-4005B Paddleboard

### VL-CBR-4005B Connectors and Indicators

This figure shows the locations of the connectors, switches, and LEDs on the VL-CBR-4005B paddleboard.

Figure 25. VL-CBR-4005B Connectors, Switches, and LEDs

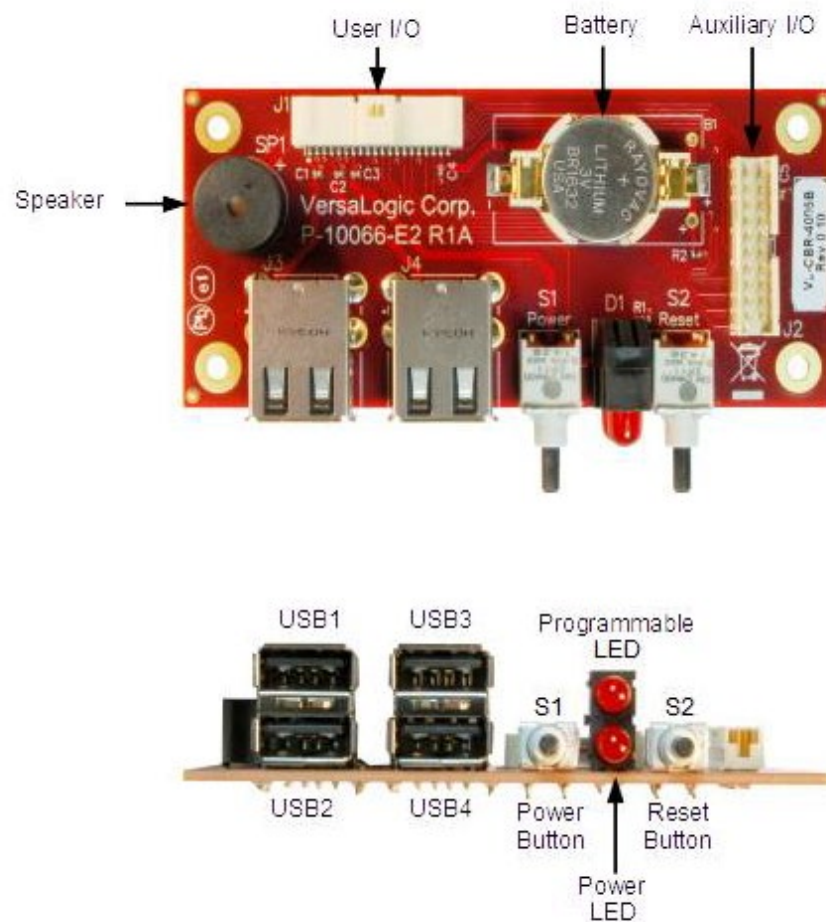

## User I/O Connector

The figure below shows the location and pin orientation of the user I/O connector.

Figure 26. Location and Pin Orientation of the User I/O Connector

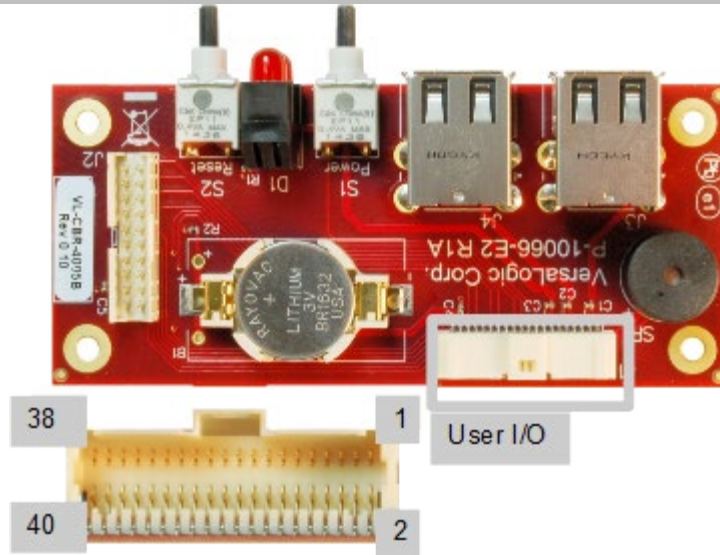

Table 20: User I/O Connector Pinout

Pin	Signal	Pin	Signal
1	+5 V	2	GND
3	USB1_P	4	USB2_P
5	USB1_N	6	USB2_N
7	+5V	8	GND
9	USB3_P	10	USB4_P
11	USB3_N	12	USB4_N
13	+3.3 V (Note 1)	14	GND
15	SPKR#	16	PLED#
17	PWR_BTN#	18	RST_BTN#
19	GND	20	GND
21	I2C Clock	22	V_BATT
23	I2C Data	24	V_BATT RETURN
25	GND	26	GND
27	GPIO1	28	GPIO2
29	GPIO3	30	GPIO4
31	GND	32	GND
33	GPIO5	34	GPIO6
35	GPIO7	36	GPIO8
37	+3.3 V (Note 2)	38	GND
39	ETH0 LED	40	ETH1 LED

### Notes:

1. This 3.3 V power goes off in sleep modes. The SPKR# uses this power as should the PLED# (there is no requirement for PLED# to use this power, but the VL-CBR-4005B paddleboard does).

2. This 3.3 V power can be turned on or off similar to the 3.3V power to the Mini Card via the FPGA (can go off in sleep modes or always stay on; by default it goes off in sleep modes). It is used for the 10 k $\Omega$  pullup resistor power on the 8x GPIOs and usually for the 2x Ethernet LEDs, however, the Ethernet LEDs can be powered by a 3.3 V power source.

### Cabling

An adapter cable, part number CBR-4005A, is available for connecting the VL-CBR-4005B paddleboard to the EPU-4562/4462. This is a 12-inch, Pico-Clasp 40-pin to 40-pin cable

If your application requires a custom cable, the following information will be useful:

CBR-4005B Board Connector	Mating Connector
Molex 501571-4007	Molex 501189-4010

### On-board Battery



#### CAUTION:

To prevent shorting, premature failure or damage to the Lithium battery, do not place the board on a conductive surface such as metal, black conductive foam or the outside surface of a metalized ESD protective pouch. The Lithium battery may explode if mistreated. Do not recharge, disassemble, or dispose of the battery in fire. Dispose of used batteries promptly.

Nominal battery voltage is 3.0 V. If the voltage drops below 2.7 V, contact the factory for a replacement. The life expectancy under normal use is approximately five years.

## Auxiliary I/O Connector

The next figure shows the location and pin orientation of the auxiliary I/O connector.

**Figure 27. Location and Pin Orientation of Auxiliary I/O Connector**

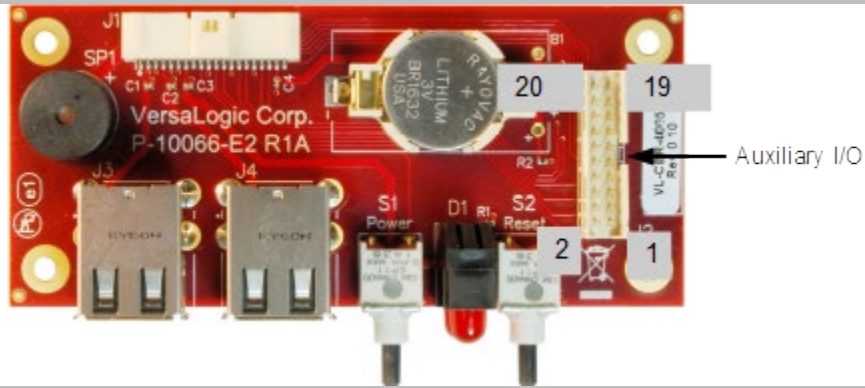

**Table 21: Auxiliary I/O Connector Pinout**

Pin	Signal	Pin	Signal
1	I2C Clock	2	V_BATT
3	I2C Data	4	V_BATT_RETURN
5	GND	6	GND
7	GPIO1	8	GPIO2
9	GPIO3	10	GPIO4
11	GND	12	GND
13	GPIO5	14	GPIO6
15	GPIO7	16	GPIO8
17	+3.3 V ( <b>Note</b> )	18	GND
19	Ethernet Port 0 LED	20	Ethernet Port 1 LED

**Notes.** Pin 17 connects to the 3.3V power on the main connector Pin 37.  
Header Part number: Amphenol 98414-F06-20ULF  
Mating connector: Amphenol 90311-020LF

## Dimensions and Mounting Holes

Figure 28. VL-CBR-4005B Dimensions and Mounting Holes

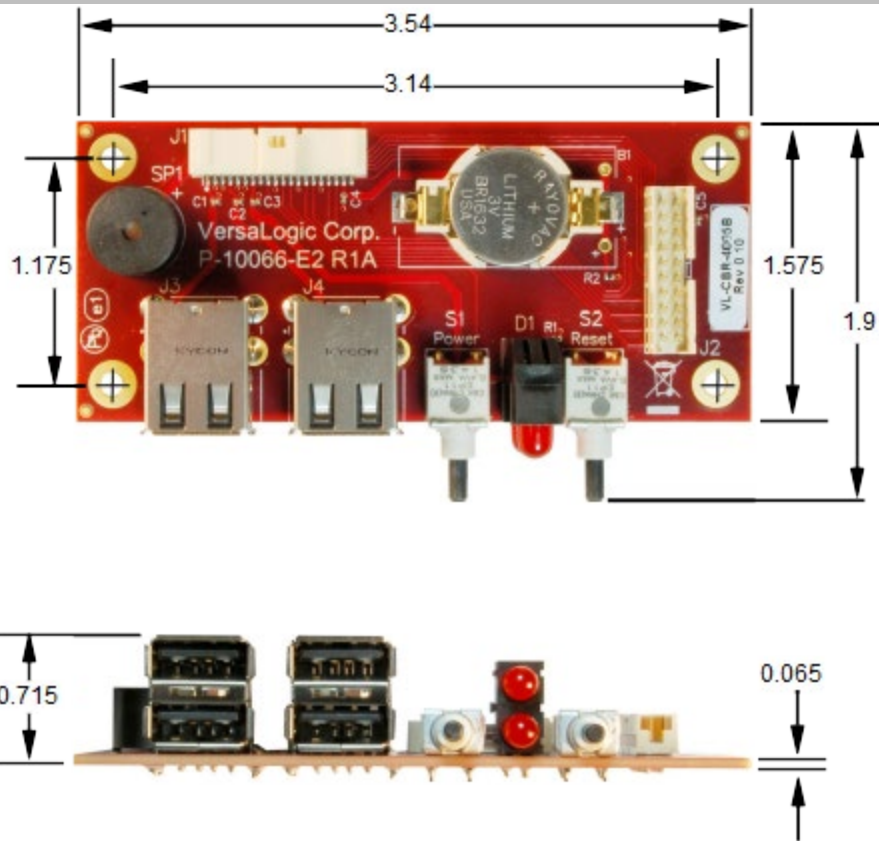

## Digital and Analog I/O Paddleboards

### Analog I/O (Using VL-CBR-2004)

To access the eight analog-to-digital inputs and four digital-to-analog outputs on the Blackbird, a paddleboard and 12-inch cable are available from VersaLogic, part number VL-CBR-2004. This section shows the locations and pin orientations of the connectors on the CBR-2004B paddleboard.

**Table 22. CBR-2004B Pinouts**

Pin	Signal	Description
1	ADC_CH1	Analog Input #1
2	ADC_CH2	Analog Input #2
3	AGND	Analog Ground
4	AGND	Analog Ground
5	ADC_CH3	Analog Input #3
6	ADC_CH4	Analog Input #4
7	AGND	Analog Ground
8	AGND	Analog Ground
9	ADC_CH5	Analog Input #5
10	ADC_CH6	Analog Input #6
11	AGND	Analog Ground
12	AGND	Analog Ground
13	ADC_CH7	Analog Input #7
14	ADC_CH8	Analog Input #8
15	AGND	Analog Ground
16	AGND	Analog Ground
17	DAC_OUT1	Analog Output #1
18	DAC_OUT2	Analog Output #2
19	DAC_OUT3	Analog Output #3
20	DAC_OUT4	Analog Output #4

Figure 29. Analog I/O and Ground Terminal Block Pinouts

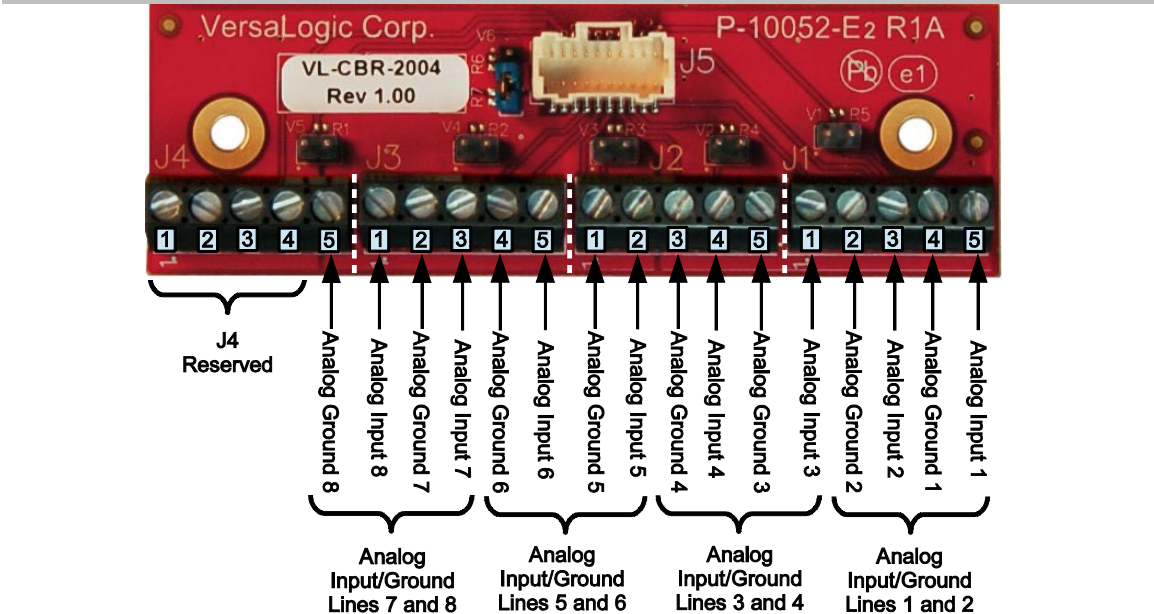

## Dimensions and Mounting Holes

Figure 30. CBR-2004B/CBR-2005 Dimensions and Mounting Holes

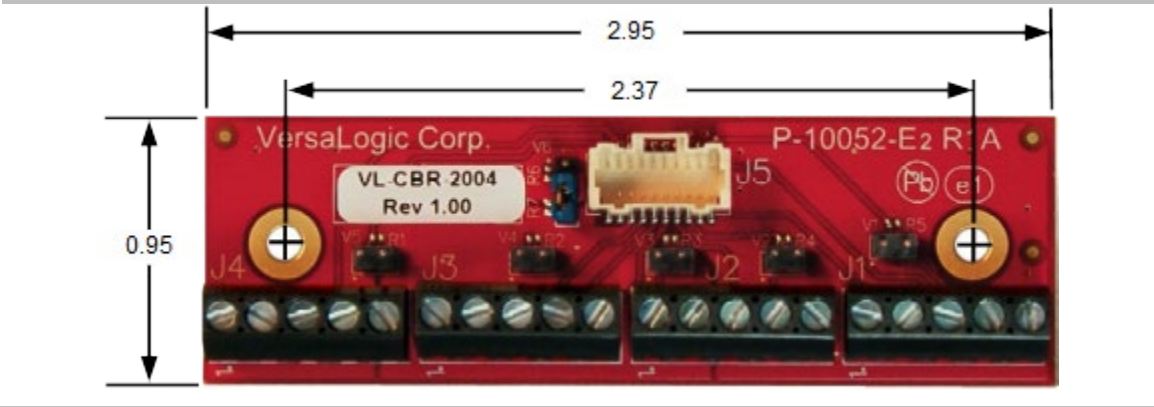



## Digital I/O (Using VL-CBR-2005)

The 20-pin I/O connector (J30) incorporates 16 Digital I/O (DIO) lines that are independently configurable as an input or output. DIO inputs can be set for normal or inverted level. DIO outputs can be set to be normal HIGH or LOW state. There are pull-up resistors to +3.3 V on all DIO lines. The pull-ups implemented — in the FPGA — can range in value from 20 k $\Omega$  to 40 k $\Omega$ . After reset, the DIO lines are set as inputs with pull-ups that will be detected as a HIGH state to external equipment.

**Figure 31: Digital I/O Connector (J30)**

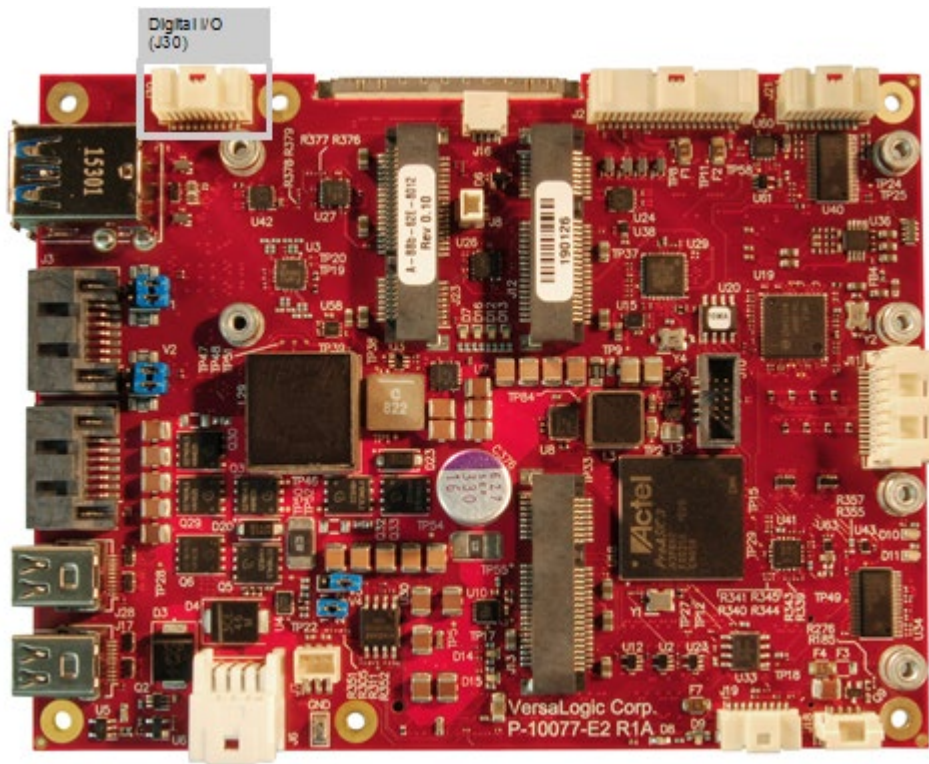

VersaLogic provides a set of application programming interface (API) calls for managing the DIO lines. See the VersaAPI Support Page for information.

The table below shows the specific Digital I/O and ground connections when using the VL-CBR-2004 paddleboard and cable VL-CBR-2005 with the Blackbird.



Table 23: Digital I/O Pinout

Pin	Signal	Description	Pin	Signal	Description
1	DIO1	Digital I/O	2	DIO2	Digital I/O
3	DIO3	Digital I/O	4	DIO4	Digital I/O
5	DGND	Digital Signal Ground	6	DIO5	Digital I/O
7	DIO6	Digital I/O	8	DIO7	Digital I/O
9	DIO8	Digital I/O	10	DGND	Digital Signal Ground
11	DIO9/OCTC5	Digital I/O (optional Timer Chan 5 Output)	12	DIO10/ICTC5	Digital I/O (optional Timer Chan 5 Output)
13	DIO11/GCTC3	Digital I/O (optional Timer Chan 3 Gate Input)	14	DIO12/GCTC4	Digital I/O (optional Timer Chan 4 Gate Input)
15	DGND	Digital Signal Ground	16	DIO13/OCTC3	Digital I/O (optional Timer 3 Output)
17	DIO14/ICTC3	Digital I/O (optional Timer 3 Input)	18	DIO15/OCTC4	Digital I/O (optional Timer 4 Output)
19	DIO16/ICTC4	Digital I/O (optional Timer 4 Input)	20	DGND	Digital Signal Ground

Consider the following guidelines when using the DIO lines.

### Voltage

The DIO lines are 3.3 V Low-voltage TTL (LVTTTL) compatible DIOs capable of sourcing/sinking up to 4 mA of current. Level shifting or current limiting is necessary when connecting signals with different voltage rails.

Figure 32. Digital I/O and Ground Terminal Block Pinouts

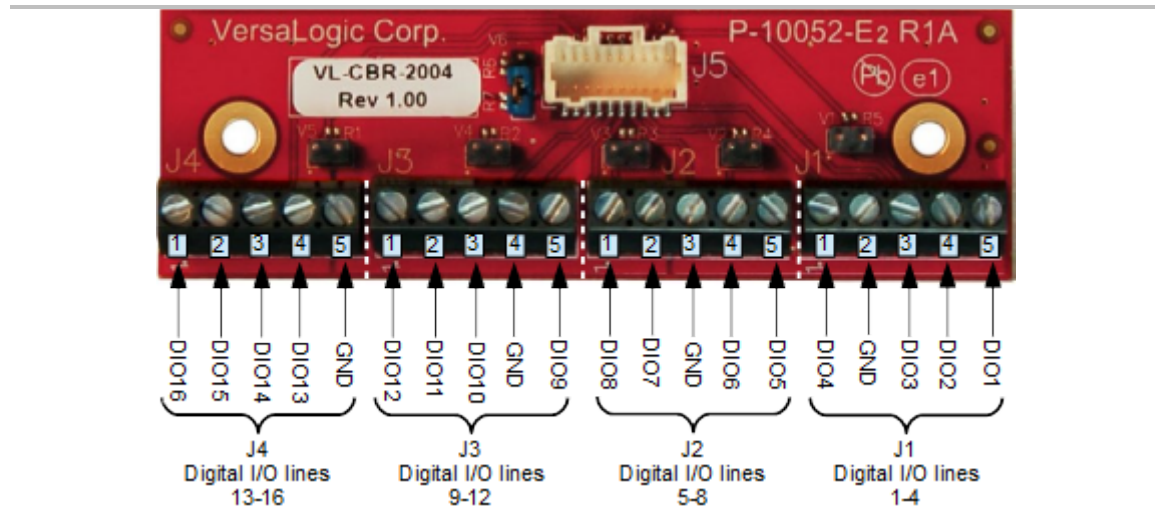

# Thermal Considerations

This chapter discusses the following topics related to thermal issues:

- Selecting the correct thermal solution for your application
- EPU-4562/4462 thermal characterization
- Installing the passive (HDW-417 heat sink), the active (HDW-418 fan) thermal solutions available from VersaLogic

## Selecting the Correct Thermal Solution for Your Application

This section provides guidelines for the overall system thermal engineering effort.

### Heat Plate

The heat plate supplied with the Blackbird is the basis of the thermal solution. The heat plate draws heat away from the CPU chip as well as other critical components. Some components rely on the ambient air temperature at or below the maximum specified 85 °C temperature.

The design of the heat plate assumes that the user's thermal solution will maintain the top surface of the heat plate at 90 °C or less. If that temperature threshold is maintained, the CPU will remain safely within its operating temperature limits.



#### CAUTION:

By itself, the heat plate is not a complete thermal solution. Integrators should either implement a thermal solution using the accessories available from VersaLogic or develop their own thermal solution that attaches to the heat plate, suitable for environments in which the EPU-4562/4462 will be used. As stated above, the thermal solution must be capable of keeping the top surface of the heat plate at or below 90 °C and the air surrounding the components in the assembly at or below 85 °C.

The heat plate is permanently affixed to the Blackbird and must not be removed. Removal of the heat plate voids the product warranty. Attempting to operate the Blackbird without the heat plate voids the product warranty and can damage the CPU.

### System-level Considerations

The Blackbird is often mounted directly to another thermally controlled surface via its heat plate (that is, the inside surface of an enclosure). In this case, the user needs to maintain the heat plate at or below 90 °C by controlling the mounting surface temperature. The EPU-4562/4462 thermal solutions available from VersaLogic – the HDW-417 heat sink with or without the HDW-418 fan block – can be used in the final system or only for product development as a temporary bench-top solution.

The ambient air surrounding the EPU-4562/4462 needs to be maintained at 85 °C or below. This may prove to be challenging depending on how and where the EPU-4562/4462 is mounted in the end user system.

The decision which thermal solution to use relies on several factors including:

- Number of CPU cores in the SoC (single, dual, or quad)
- CPU and video processing utilization by the user application
- Temperature range within which the EPU-4562/4462 will be operated
- Air movement (or lack of air movement)

Most of these factors involve the demands of the user application on the EPU-4562/4462 and cannot be isolated from the overall thermal performance. Due to the interaction of the user application, the Blackbird thermal solution, and the overall environment of the end system, thermal performance cannot be rigidly defined.

The ambient air surrounding the EPU-4562/4462 needs to be maintained at 85 °C or below. This would include the space between the two main boards as well as the space beneath an installed Mini PCIe expansion board. Standard methods for addressing this requirement include the following:

- Provide a typical airflow of 100 linear feet per minute (LFM) / 0.5 linear meters per second (as described in the section titled EPU-4562/4462 Thermal Characterization, beginning on page 70) within the enclosure
- Position the EPU-4562/4462 board to allow for convective airflow
- Lower the system level temperature requirement as needed

### CPU Thermal Trip Points

The CPU cores in the Blackbird have their own thermal sensors. Coupled with these sensors are specific reactions to three thermal trip points. The table below describes the three thermal trip points. Note that these are internal temperatures that are about 10 °C above the heat plate temperature.

**Table 24: CPU Thermal Trip Points**

Trip Point	Description
Passive (Note 1)	At this temperature, the CPU cores throttle back to a lower speed. This reduces the power draw and heat dissipation, but lowers the processing speed.
Critical (Note 2)	At this temperature, the operating system typically puts the board into a sleep or other low-power state.
Maximum core temperature	The CPU turns itself off when this temperature is reached. This is a fixed trip point and cannot be adjusted.

**Notes:**

1. The default value in the BIOS Setup utility for this trip point is 90 °C.
2. The default value in the BIOS Setup utility for this trip point is 100 °C.

These trip points allow maximum CPU operational performance while maintaining the lowest CPU temperature possible. The long-term reliability of any electronic component degrades when it is continually run near its maximum thermal limit. Ideally, the CPU core temperatures will be kept well below 100 °C with only brief excursions above.

CPU temperature monitoring programs are available to run under both Windows and Linux. The next table lists some of these hardware monitoring programs.

**Table 25: Temperature Monitoring Programs**

Operating System	Program Type	Description
Windows	Core Temperature	<a href="http://www.alcpu.com/CoreTemp/">http://www.alcpu.com/CoreTemp/</a>
	Hardware Monitor	<a href="http://www.cpuid.com/softwares/hwmonitor.html">http://www.cpuid.com/softwares/hwmonitor.html</a>
	Open Hardware Monitor	<a href="http://openhardwaremonitor.org/">http://openhardwaremonitor.org/</a>
Linux	lm-sensors	<a href="http://en.wikipedia.org/wiki/Lm_sensors">http://en.wikipedia.org/wiki/Lm_sensors</a>

## Thermal Specifications, Restrictions, and Conditions

Graphical test data is in the section titled EPU-4562/4462 Thermal Characterization, beginning on page 70. Refer to that section for the details behind these specifications. These specifications are the thermal limits for using the EPU-4562/4462 with one of the defined thermal solutions.

Due to the unknown nature of the entire thermal system, or the performance requirement of the application, VersaLogic cannot recommend a particular thermal solution. This information is intended to provide guidance in the design of an overall thermal system solution.

**Table 26: Absolute Minimum and Maximum Air Temperatures**

Board	With Heat Plate	With Heat Sink (HDW-417)	With Heat Sink + Fan (HDW-417 + HDW-418)
VL-EPU-4562/4462 EBP	-40 ° to +85 °C	-40 ° to +85 °C	-40 ° to +85 °C
VL-EPU-4562/4462 ECP	-40 ° to +85 °C	-40 ° to +85 °C	-40 ° to +85 °C

### Overall Restrictions and Conditions:

- Ranges shown assume less than 90% CPU utilization.
- Keep the maximum CPU core temperature below 100°C.
- The ambient air surrounding the EPU-4562/4462 needs to be maintained at 85 °C or below. This includes the space between the two main boards as well as the space beneath an installed Mini PCIe expansion board. A recommended overall airflow of 100 linear feet per minute (LFM) / 0.5 linear meters per second (LMS) addresses this requirement. If this air flow is not provided, other means must be implemented to keep the adjacent air at 85 °C or below.

### Heat Plate Only Restrictions and Conditions:

- The heat plate must be kept below 90 °C. This applies to a heat plate mounted directly to another surface.

### Heat Sink Only Considerations:

- At 85°C air temperature and 90% CPU utilization, there will be little if any thermal margin to a CPU core temperature of 100 °C or the passive trip point (see test data). If this is the use case, consider adding a fan or other additional airflow.

### Heat Sink with Fan Considerations:

- The heat sink and fan combination cools the CPU when it is running in high temperature environments, or when the application software is heavily utilizing the CPU or video circuitry. The fan assists in cooling the heat sink and provides additional air movement within the system.



**Integrator's Note:** The ambient air surrounding the EPU-4562/4462 needs to be maintained at 85 °C or below.

## EPU-4562/4462 Thermal Characterization

The EPU-4562/4462 board underwent the following thermal characterization tests:

- Test Scenario 1: Core i5 EPU-4562-EBP – active and passive thermal characterization.
- Test Scenario 2: Core i7 EPU-4562-ECP – active and passive thermal characterization.
- The table below describes the thermal testing setup for the board.

**Table 27: EPU-4562/4462 Thermal Testing Setup**

<b>Hardware configuration</b>	EPU-4562/4462 (Blackbird) dual/quad core CPU with: <ul style="list-style-type: none"> <li>▪ 16 GB of DDR4 DRAM</li> <li>▪ HDW-417 (passive heat sink)</li> <li>▪ HDW-418 (heat sink fan)</li> <li>▪ One VGA display device (connected through the LVDS interface), one display for monitor</li> <li>▪ Two SATA hard disk drives</li> <li>▪ Two RS-232 ports in loopback configuration</li> <li>▪ One VersaLogic VL-MPEe-E3 Mini PCIe Gigabit Ethernet module</li> <li>▪ Two active Ethernet ports in loopback configuration</li> <li>▪ Two USB 2.0 ports in loopback configuration (<b>Note</b>)</li> <li>▪ USB keyboard and mouse (<b>Note</b>)</li> </ul>
<b>BIOS</b>	<ul style="list-style-type: none"> <li>▪ ID string: VER2A000</li> <li>▪ Passive thermal trip point setting: 105 °C</li> <li>▪ Critical thermal trip point setting: 111 °C</li> </ul>
<b>Operating system</b>	<ul style="list-style-type: none"> <li>▪ Microsoft Windows* 10 Enterprise</li> </ul>
<b>Test software</b>	<ul style="list-style-type: none"> <li>▪ Passmark BurnIn* Test v8.1 b1018               <ul style="list-style-type: none"> <li>- CPU utilization ~90%</li> </ul> </li> <li>▪ Intel Thermal Analysis Tool* (TAT) v5.0.1026               <ul style="list-style-type: none"> <li>- Primarily used to read the CPU core temperature</li> </ul> </li> </ul>
<b>Test environment</b>	<ul style="list-style-type: none"> <li>▪ Thermal chamber</li> </ul>

**Note:** This device connects through a VersaLogic VL-CBR-4005B paddleboard.

The test results reflect the test environment within the temperature chamber used. The airflow of this particular chamber is about 0.5 linear meters per second (~100 linear feet per minute). Thermal performance improves by increasing the airflow beyond 0.5 linear meters per second.

The system power dissipation is primarily dependent on the application program; that is, its use of computing or I/O resources. The stress levels used in this testing are at the top of the range of a typical user's needs.

## Test Results

### Test Scenario 1: Dual Core EPU-4562-EBP – Passive and Active Thermal Characterization

Shown in the figure below, running the test scenario with just the heat sink, the core temperature is slightly above 100 °C at maximum ambient temperature. This will be less in most applications that require less than 90% CPU utilization. Adding the fan provides an additional 5-6 °C of margin. For long-term reliability, ensure the CPU cores are predominately running with their temperatures below 100 °C.

Figure 33. EPU-4562-EBP Quad Core Temperature Relative to Ambient Temperature

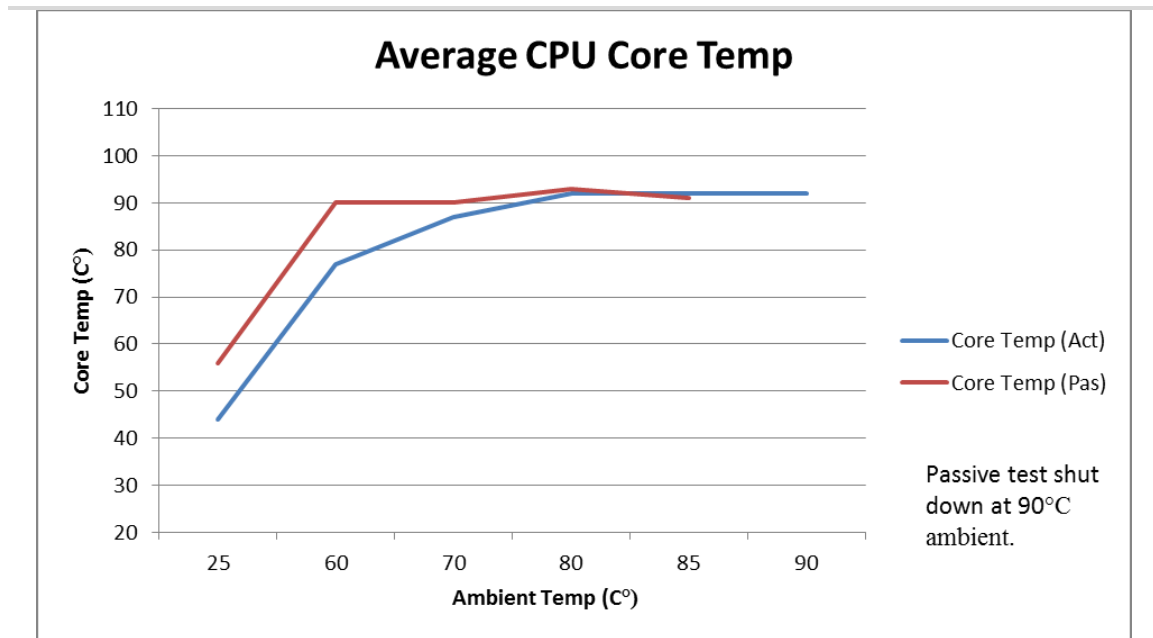

**Test Scenario 2: Core i7 EPU-4562- ECP – Passive and Active Thermal Characterization**

As shown below, the quad core version of the Blackbird will typically require a heat sink + fan for operation above 80 °C, at >90% CPU utilization.

**Figure 34. EPU-4562-ECP Quad Core Temperature Relative to Ambient Temperature**

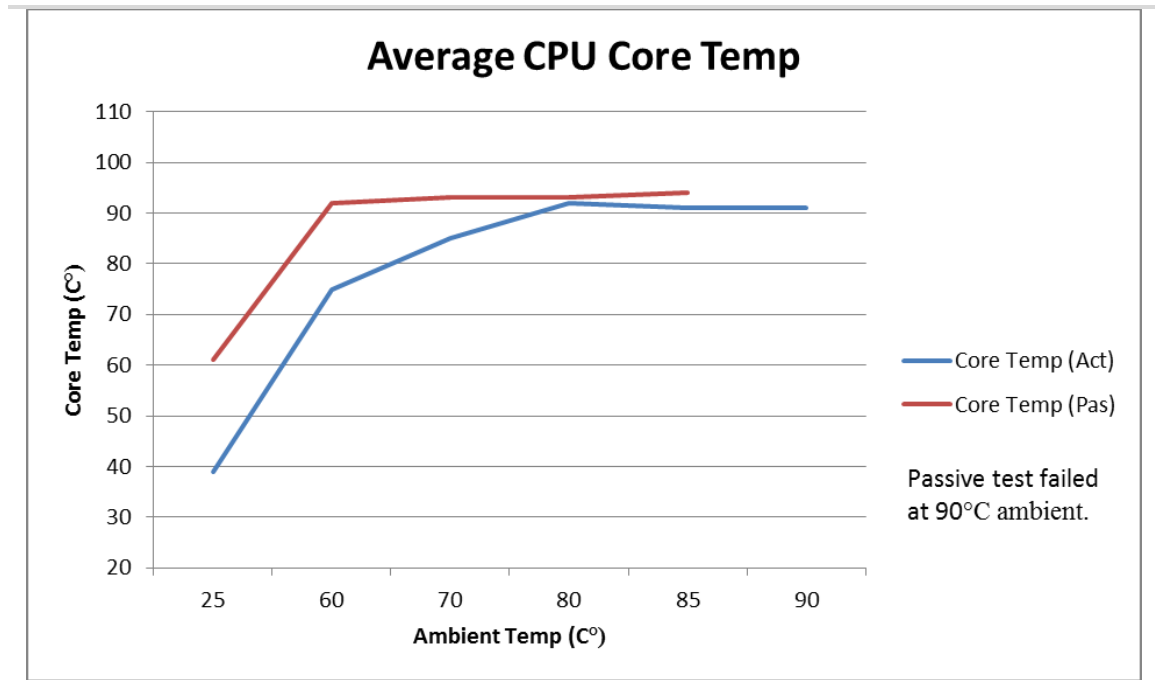



### Installing VersaLogic Thermal Solutions

The following thermal solution accessories are available from VersaLogic:

- VL-HDW-401 Thermal Compound Paste – used to mount the heat sink to the heat plate
- VL-HDW-417 Passive Heat Sink – mounts to standard product.
- VL-HDW-418 Fan Assembly – Cooling fan for the HDW-417 passive heatsink. Operates at +12 V and includes an EPU-4562/4462 compatible connector

### Hardware Assembly

There are two basic assembly methods:

- Heat plate down (in relation to the enclosure)
- Heat plate up

These assembly methods are shown in Figure 36 and Figure 37 respectively.

#### Heat Plate Down

The figure below (a representative image of a similar VersaLogic product) shows the assembly. Use this assembly method if you are attaching the Blackbird to a larger thermal solution such as a metal chassis/enclosure.

**Figure 35. Hardware Assembly with Heat Plate Down**



A thermal interface compound must be applied to the heat plate to thermally bond it to the mounting plate or other surface to which the Blackbird is mounted. Spread the compound thinly and evenly across the entire heat plate surface before mounting. The compound is supplied in the VL-CKR-BLACKBIRD cable kit or sold separately as part number VL-HDW-401.

**Note:** The maximum heat plate temperature for the EPU-4562-ECP-xx models is 80 °C.

## Installing the VL-HDW-417 Passive Heat Sink

### 1. Apply the Arctic Silver<sup>®</sup> Thermal Compound (VL-HDW-401)

- Apply the thermal compound to the heat plate using the method described on the Arctic Silver website - <http://www.arcticsilver.com/>

### 2. Position the passive heat sink

- Using the next figure as a guide, align the seven mounting holes of the heat sink with the heat plate.
- Orient the heat sink fins in the direction of the system airflow to maximize CPU cooling.

### 3. Secure the passive heat sink to the heat plate

- Affix the passive heat sink to the heat plate using seven M2.5 pan head screws.
- Using a torque screwdriver, tighten the screws to 4.0 inch-pounds.

Figure 36. Installing the Passive Heat Sink

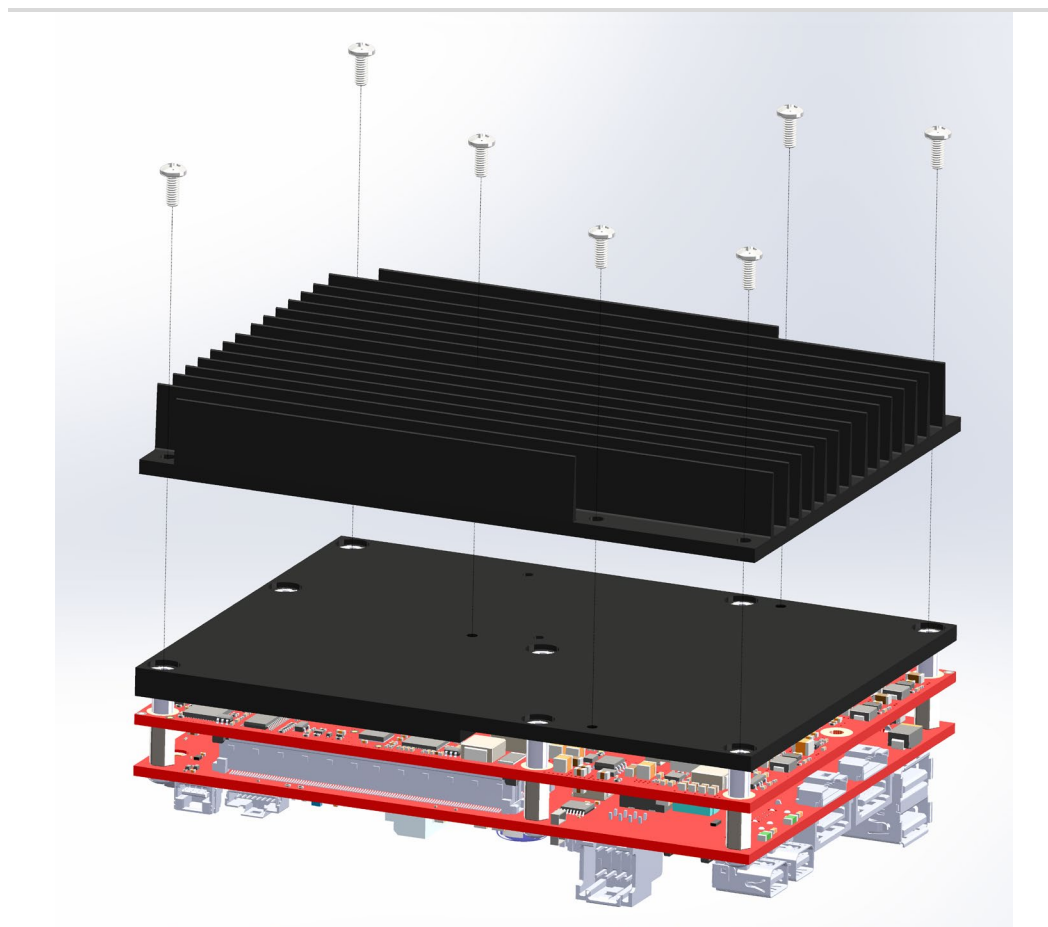

## Installing the VL-HDW-418 Heat Sink Fan

### 1. Position the fan assembly

- Using the figure below as a guide, align the mounting holes of the heat sink fan with the four holes in the passive heat sink. Position the fan so that its power cable can easily reach its mating connector (J18).

### 2. Secure the fan to the heat sink

- Affix the heat sink fan using four M3 pan head screws.
- Using a torque screwdriver, tighten the screws to 4.0 inch-pounds.

### 3. Connect power to the fan

- Connect the fan's power cable to J18 on the EPU-4562/4462.

**Figure 37. Installing the Heat Sink Fan**



## Operating Systems

- In Linux, a dual-display configuration (using both the LVDS and the Mini DisplayPort++ connectors) will fail to show output on the LVDS port unless the operating system is configured to boot in UEFI mode. Single display configurations do not have an issue.
- In Ubuntu 14.04, if an LVDS monitor goes into power saving mode or the operating system goes into suspend or hibernate mode, the LVDS monitor will fail to come back on.

*\*\*\* End of document \*\*\**