

XLamp® CHA0825 LED



PRODUCT DESCRIPTION

The XLamp® CHA LED family delivers an industry-leading combination of lumen density and efficacy in LES sizes as small as 3.3 mm. CHA family LEDs deliver 50% higher lumen density than the existing XLamp CMU family LEDs for significant improvements in beam angle and intensity. The XLamp CHA family LEDs are also compatible with the available ecosystem of holders and optics designed for high-intensity COBs.

XLamp CHA LEDs are optimized for premium indoor lighting applications, including track, spot and downlight, as well as outdoor lighting.

FEATURES

- 8.5-mm optical source
- Available in 80-, 90- and 95-degree minimum CRI options
- EasyWhite® 2- and 3-step binning
- Premium Color 2- and 3-step binning
- Forward voltage option: 36-V class
- 85 °C binning and characterization
- Maximum drive current: 1200 mA
- 114° viewing angle, uniform chromaticity profile
- Top-side solder connections
- RoHS and REACH compliant
- UL® recognized component (E349212)

TABLE OF CONTENTS

Characteristics	2
Operating Limits.....	2
Flux Characteristics, Order Codes and Bins - Standard LEDs.....	3
Flux Characteristics, Order Codes & Bins - Standard LEDs, Premium Color.....	4
Relative Spectral Power Distribution, Standard LEDs.....	5
Relative Spectral Power Distribution, Standard LEDs, Premium Color.....	6
Electrical Characteristics.....	8
Relative Luminous Flux.....	9
Typical Spatial Distribution.....	9
EasyWhite® Performance Groups - Chromaticity	10
Premium Color Performance Groups - Chromaticity	11
EasyWhite® Bins Plotted on the 1931 CIE Color Space	12
Premium Color Bins Plotted on the 1931 CIE Color Space.....	13
Bin and Order Code Formats.....	15
Mechanical Dimensions	16
Thermal Design	17
Notes	18
Packaging.....	19



Cree LED / 4400 Silicon Drive / Durham, NC 27703 USA / +1.919.313.5330 / www.cree-led.com

CHARACTERISTICS

Characteristics	Unit	Minimum	Typical	Maximum
Viewing angle (FWHM)	degrees		114	
ESD withstand voltage (JEDEC JS-001-2012)	V		Class 3A	
DC forward current	mA			1200*
Reverse current	mA			0.1
Forward voltage (@ 700 mA, 85 °C)	V		36	38.5

* Refer to the Operating Limits section.

OPERATING LIMITS

The maximum current rating of the CHA0825 depends on the case temperature (Tc) when the LED has reached thermal equilibrium under steady-state operation. The graphs shown below assume that the system design employs good thermal management (thermal interface material and heat sink) and may vary when poor thermal management is employed. Either solder pad shown in the Mechanical Dimensions section on page 16 can be used as the Tc measurement point.

Another important factor in good thermal management is the temperature of the Light Emitting Surface (LES). Cree LED recommends a maximum LES temperature of 140 °C to ensure optimal LED lifetime. Please refer to the Thermal Design section on page 17 for more information on LES temperature measurement.

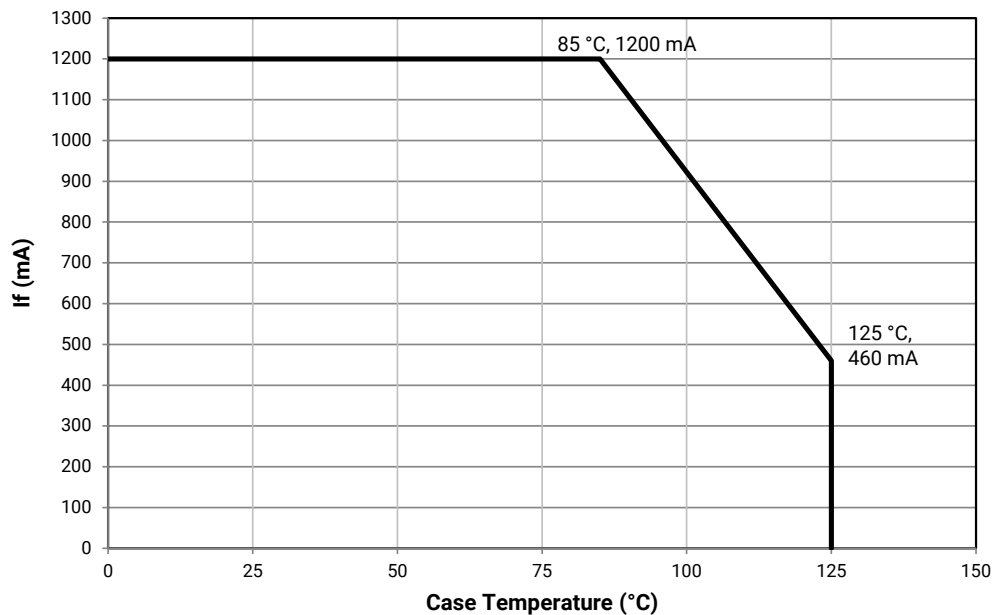

FLUX CHARACTERISTICS, ORDER CODES AND BINS - STANDARD LEDS ($I_F = 700 \text{ mA}$, $T_J = 85 \text{ °C}$)

The following table provides order codes for XLamp CHA0825 LEDs. For a complete description of the order code nomenclature, please see the Bin and Order Code Formats section (page 15).

Nominal CCT	CRI		Minimum Luminous Flux (lm)	Typical Luminous Flux (lm)	2-Step		3-Step	
	Min.	Typ			Group	Order Code	Group	Order Code
4000 K	80	82	3229	3399	40H	CHA0825-0000-000N0H0A40H	40G	CHA0825-0000-000N0H0A40G
	90	92	2816	2964	40H	CHA0825-0000-000N0U0A40H	40G	CHA0825-0000-000N0U0A40G
3500 K	80	82	3148	3314	35H	CHA0825-0000-000N0H0A35H	35G	CHA0825-0000-000N0H0A35G
	90	92	2748	2892	35H	CHA0825-0000-000N0U0A35H	35G	CHA0825-0000-000N0U0A35G
3000 K	80	82	3053	3214	40H	CHA0825-0000-000N0H0A30H	30G	CHA0825-0000-000N0H0A30G
	90	92	2633	2772	30H	CHA0825-0000-000N0U0A30H	30G	CHA0825-0000-000N0U0A30G
2700 K	80	82	2918	3071	27H	CHA0825-0000-000N0H0A27H	27G	CHA0825-0000-000N0H0A27G
	90	92	2491	2622	27H	CHA0825-0000-000N0U0A27H	27G	CHA0825-0000-000N0U0A27G

Notes

- Cree LED maintains a tolerance of $\pm 7\%$ on flux and power measurements, ± 0.005 on chromaticity (CCx, CCy) measurements and a tolerance of ± 2 on CRI measurements. See the Measurements section (page 18).
- For 80 CRI minimum LEDs, CRI R9 minimum is 0 with a ± 2 tolerance. For 90 CRI minimum LEDs, CRI R9 typical is 60.

FLUX CHARACTERISTICS, ORDER CODES & BINS - STANDARD LEDS, PREMIUM COLOR (I_F = 700 mA, T_J = 85 °C)

Fidelity

Nominal CCT	CRI		Minimum Luminous Flux (lm)	Typical Luminous Flux (lm)	2-Step	
	Min.	Typ			Group	Order Code
4000 K	95	98	2534	2667	40H	CHA0825-0000-000N0Z0A40H
3500 K	95	98	2520	2653	35H	CHA0825-0000-000N0Z0A35H
3000 K	95	98	2299	2420	30H	CHA0825-0000-000N0Z0A30H
2700 K	95	98	2185	2300	27H	CHA0825-0000-000N0Z0A27H

Specialty

Nominal CCT	CRI		Minimum Luminous Flux (lm)	Typical Luminous Flux (lm)	2-Step		3-Step			
	Min.	Typ			Group	Order Code	Group	Order Code	Group	Order Code
3100 K	90	92	2513	2645			31Q	CHA0825-0000-000N0U0A31Q		
3000 K	90	92	2579	2715			30Q	CHA0825-0000-000N0U0A30Q		
			2474	2604					30U	CHA0825-0000-000N0U0A30U
	95	98	2190	2305	L7C	CHA0825-0000-000N0Z0AL7C				

- Notes**
- Cree LED maintains a tolerance of ±7% on flux and power measurements, ±0.005 on chromaticity (CCx, CCy) measurements and a tolerance of ±2 on CRI measurements. See the Measurements section (page 18).
 - For 80 CRI minimum LEDs, CRI R9 minimum is 0 with a ±2 tolerance. For 90 CRI minimum LEDs, CRI R9 typical is 60.

RELATIVE SPECTRAL POWER DISTRIBUTION, STANDARD LEDs

The following graphs are the result of a series of pulsed measurements at 700 mA and $T_j = 85^\circ\text{C}$.

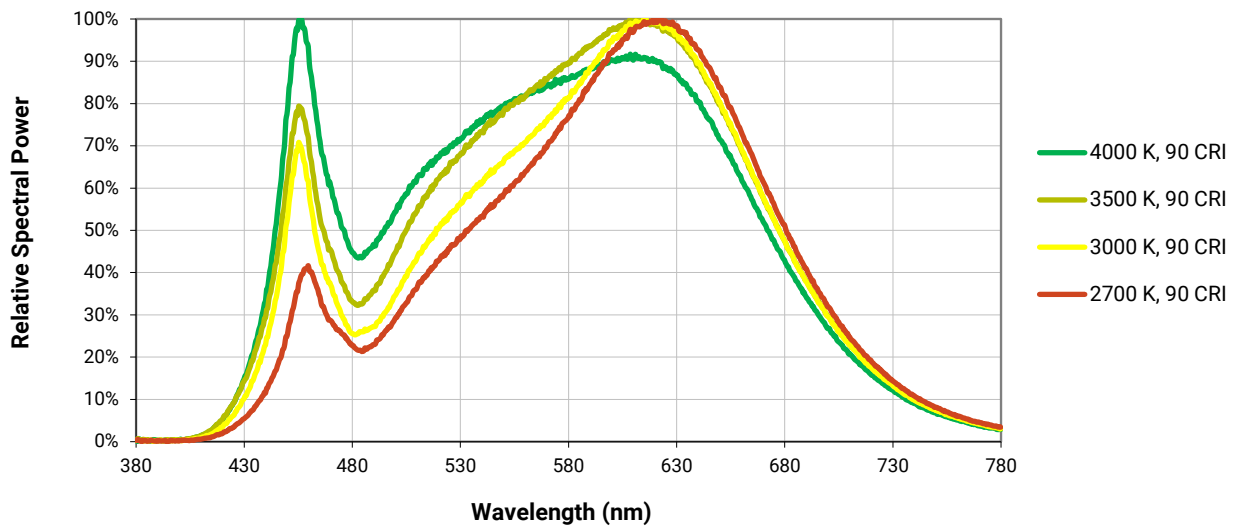
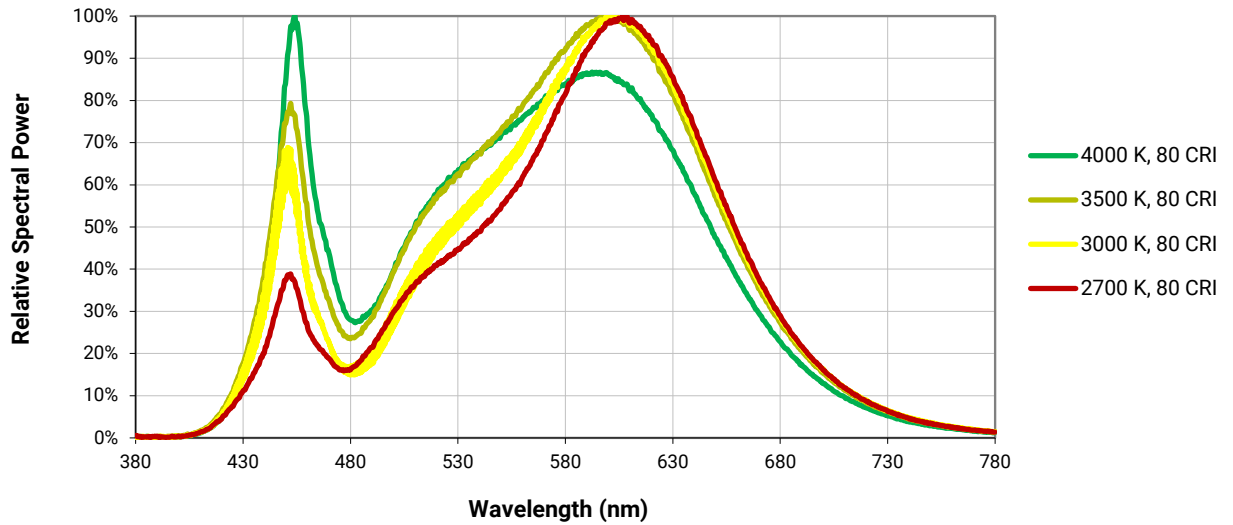

RELATIVE SPECTRAL POWER DISTRIBUTION, STANDARD LEDS, PREMIUM COLOR

The following graphs are the result of a series of pulsed measurements at 700 mA and $T_j = 85\text{ }^\circ\text{C}$.

Fidelity

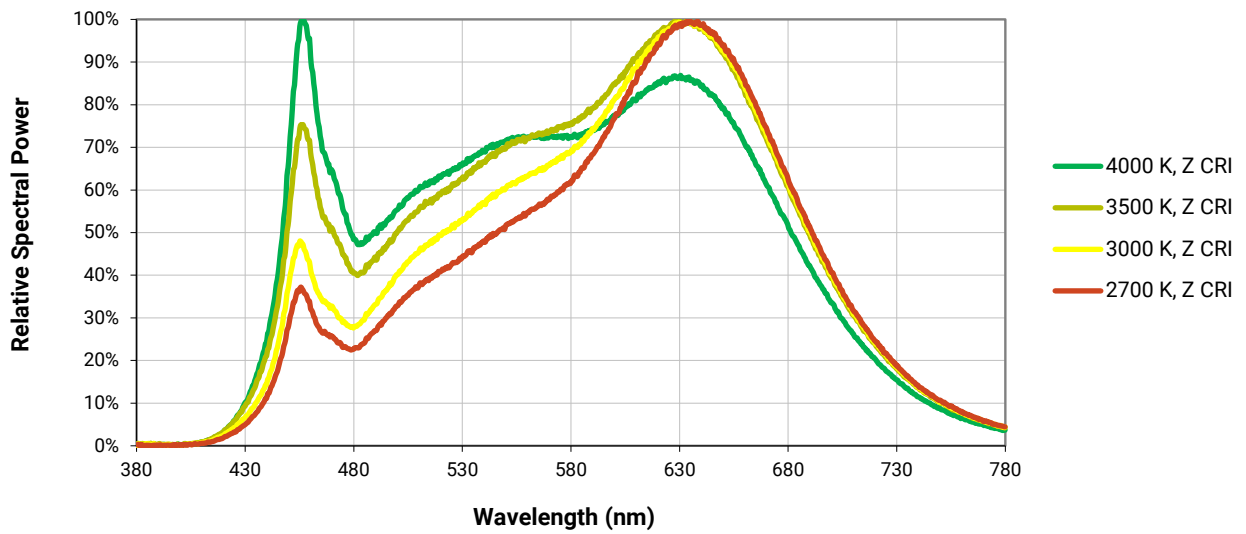

RELATIVE SPECTRAL POWER DISTRIBUTION - STANDARD LEDs, PREMIUM COLOR (CONTINUED)

Specialty

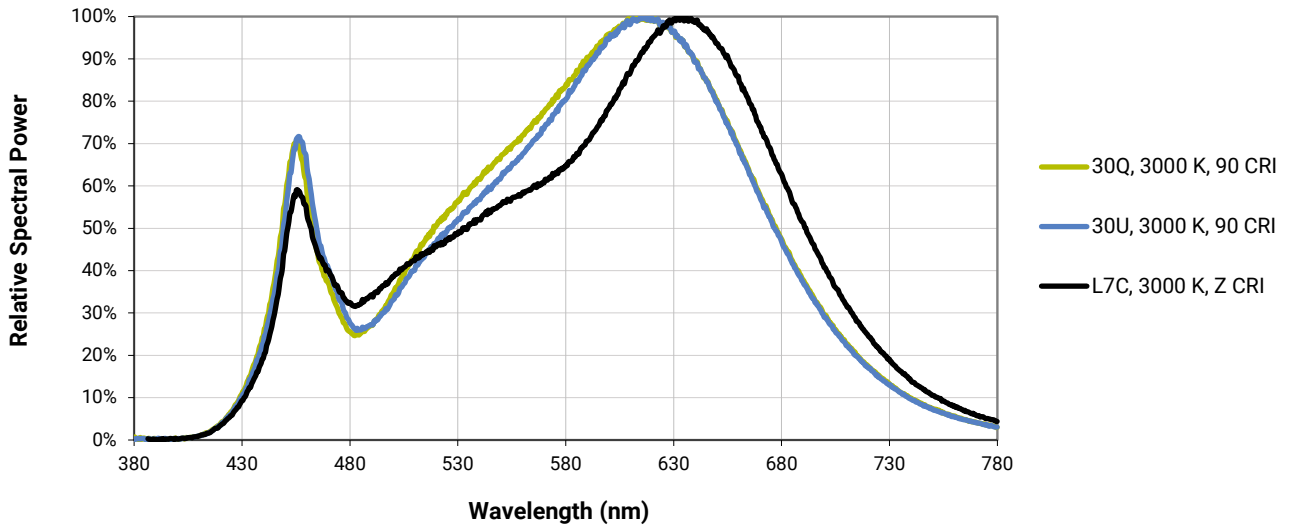
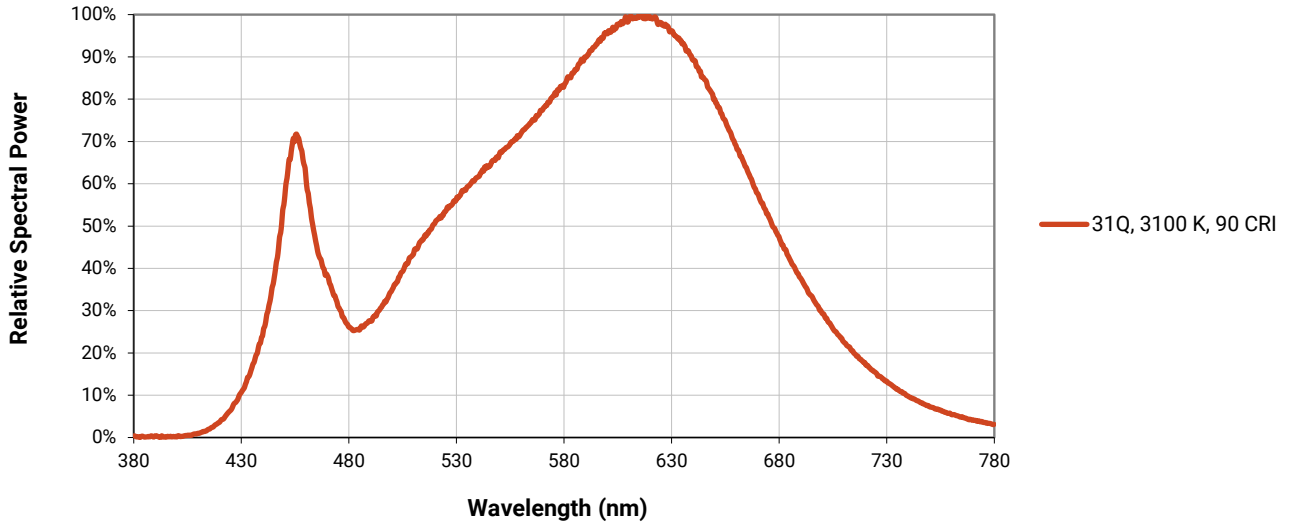

ELECTRICAL CHARACTERISTICS

The following graph is the result of a series of steady-state measurements.

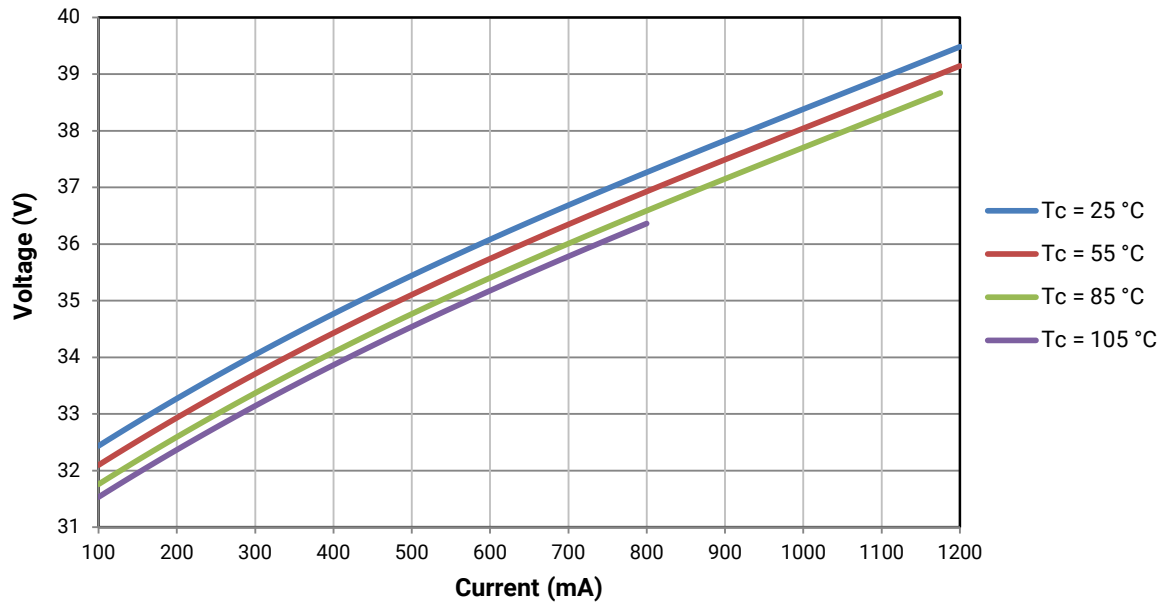

RELATIVE LUMINOUS FLUX

The relative luminous flux values provided below are the ratio of:

- Measurements of CHA0825 at steady-state operation at the given conditions, divided by
- Flux measured during binning, which is a pulsed measurement at 700 mA at $T_j = 85\text{ }^\circ\text{C}$.

For example, at steady-state operation of $T_c = 55\text{ }^\circ\text{C}$, $I_f = 900\text{ mA}$, the relative luminous flux ratio is 125% in the chart below. A CHA0825 LED that measures 3482 lm during binning will deliver 4353 lm (3482×1.25) at steady-state operation of $T_c = 55\text{ }^\circ\text{C}$, $I_f = 900\text{ mA}$.

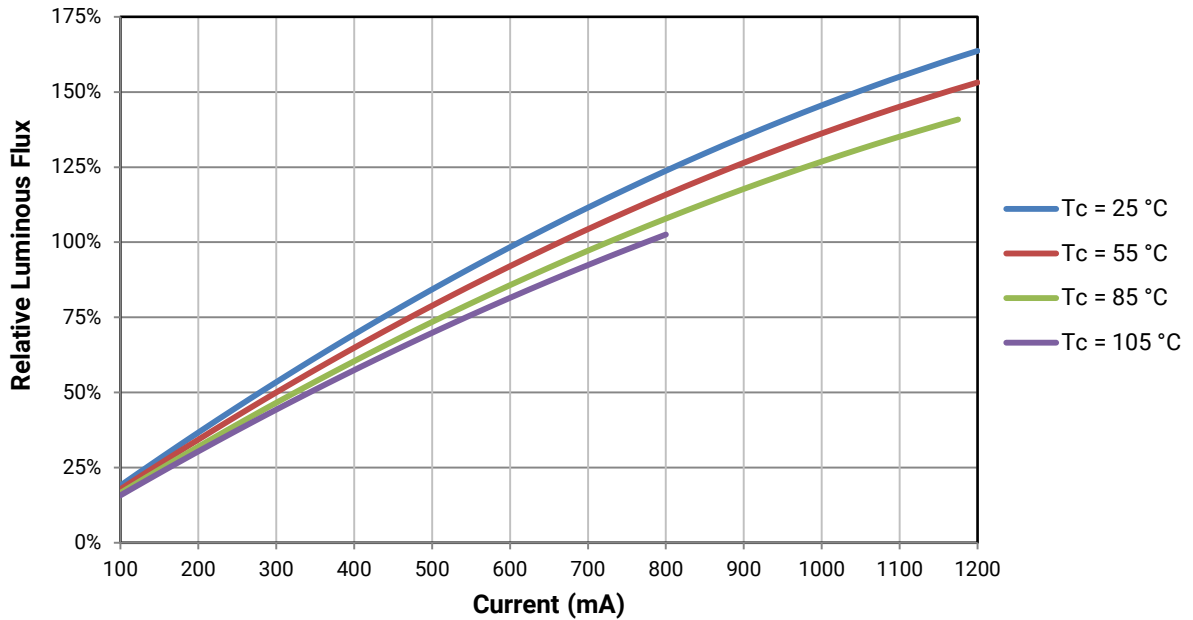

TYPICAL SPATIAL DISTRIBUTION

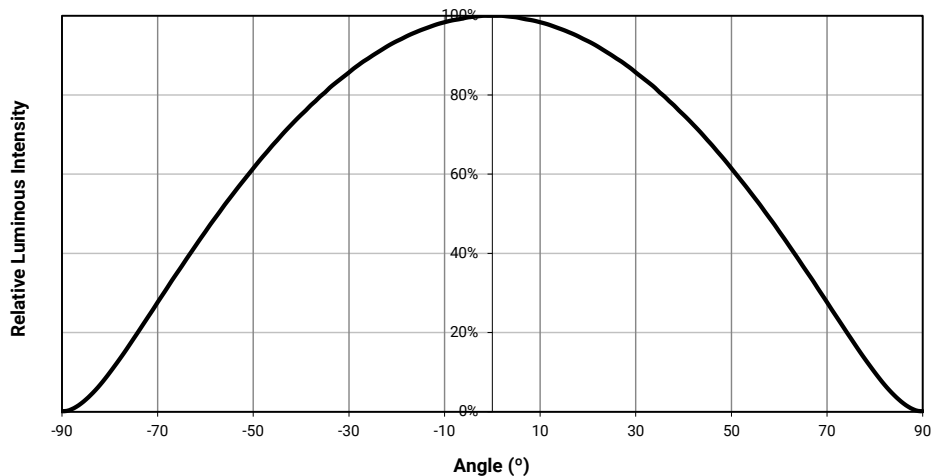

EASYWHITE® PERFORMANCE GROUPS - CHROMATICITY ($T_j = 85\text{ °C}$)

XLamp CHA0825 LEDs are tested for chromaticity and placed into one of the regions defined by the following bounding coordinates.

EasyWhite Color Temperatures – 2-Step			
Code	CCT	x	y
40H	4000 K	0.3777	0.3739
		0.3797	0.3816
		0.3861	0.3855
		0.3838	0.3777
35H	3500 K	0.4022	0.3858
		0.4053	0.3942
		0.4125	0.3977
		0.4091	0.3891
30H	3000 K	0.4287	0.3975
		0.4328	0.4064
		0.4390	0.4086
		0.4347	0.3996
27H	2700 K	0.4524	0.4048
		0.4574	0.4140
		0.4633	0.4154
		0.4581	0.4062

EasyWhite Color Temperatures – 3-Step Ellipse						
Bin Code	CCT	Center Point		Major Axis	Minor Axis	Rotation Angle (°)
		x	y	a	b	
40G	4000 K	0.3818	0.3797	0.00939	0.00402	53.7
35G	3500 K	0.4073	0.3917	0.00927	0.00414	54.0
30G	3000 K	0.4338	0.4030	0.00834	0.00408	53.2
27G	2700 K	0.4577	0.4099	0.00834	0.00420	48.5

PREMIUM COLOR PERFORMANCE GROUPS - CHROMATICITY ($T_j = 85\text{ }^\circ\text{C}$)

XLamp CHA0825 LEDs are tested for chromaticity and placed into one of the regions defined by the following bounding coordinates.

Fidelity

EasyWhite Color Temperatures – 2-Step			
Code	CCT	x	y
40H	4000 K	0.3777	0.3739
		0.3797	0.3816
		0.3861	0.3855
		0.3838	0.3777
35H	3500 K	0.4022	0.3858
		0.4053	0.3942
		0.4125	0.3977
		0.4091	0.3891
30H	3000 K	0.4287	0.3975
		0.4328	0.4064
		0.4390	0.4086
		0.4347	0.3996
27H	2700 K	0.4524	0.4048
		0.4574	0.4140
		0.4633	0.4154
		0.4581	0.4062

Specialty

EasyWhite Color Temperatures – 2-Step			
Code	CCT	x	y
L7C	3000 K	0.4192	0.3754
		0.4224	0.3823
		0.4291	0.3847
		0.4257	0.3777

EasyWhite Color Temperatures – 3-Step Ellipse						
Bin Code	CCT	Center Point		Major Axis	Minor Axis	Rotation Angle (°)
		x	y	a	b	
31Q	3100 K	0.4236	0.3888	0.00848	0.00455	50.3
30Q	3000 K	0.4305	0.3935	0.00834	0.00408	53.2
30U	3000 K	0.4274	0.3837	0.00834	0.00408	53.2

EASYWHITE® BINS PLOTTED ON THE 1931 CIE COLOR SPACE ($T_j = 85\text{ }^\circ\text{C}$)

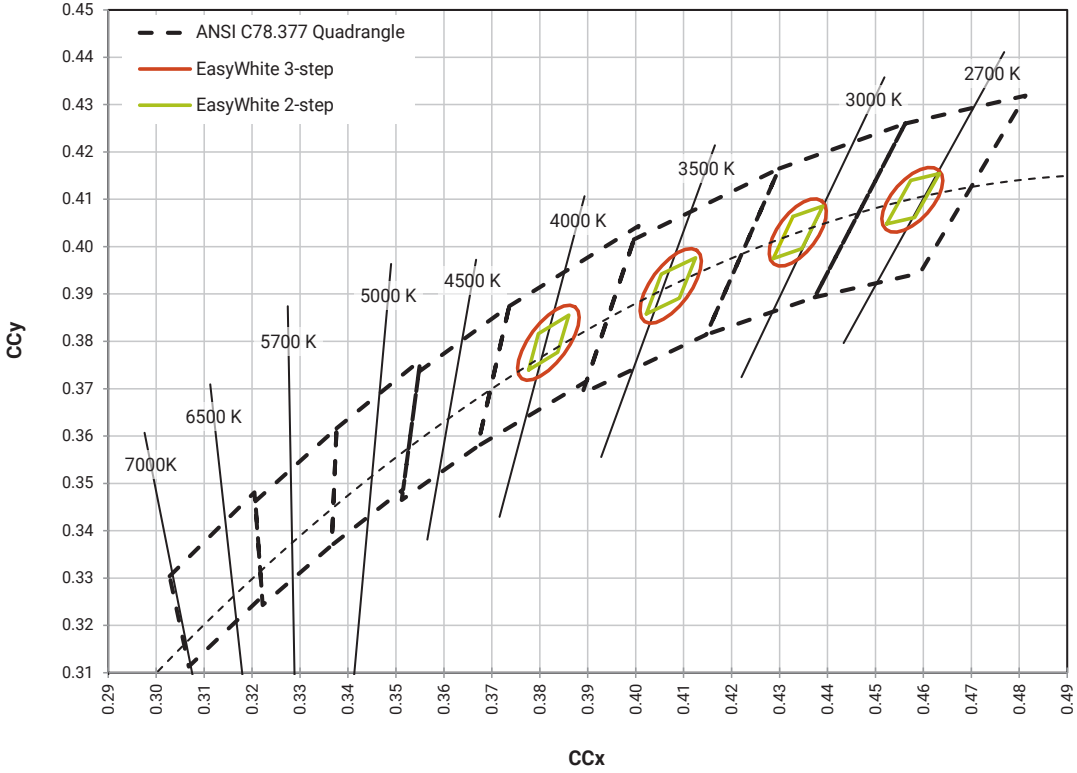

PREMIUM COLOR BINS PLOTTED ON THE 1931 CIE COLOR SPACE ($T_j = 85\text{ }^\circ\text{C}$)

Fidelity (2-step)

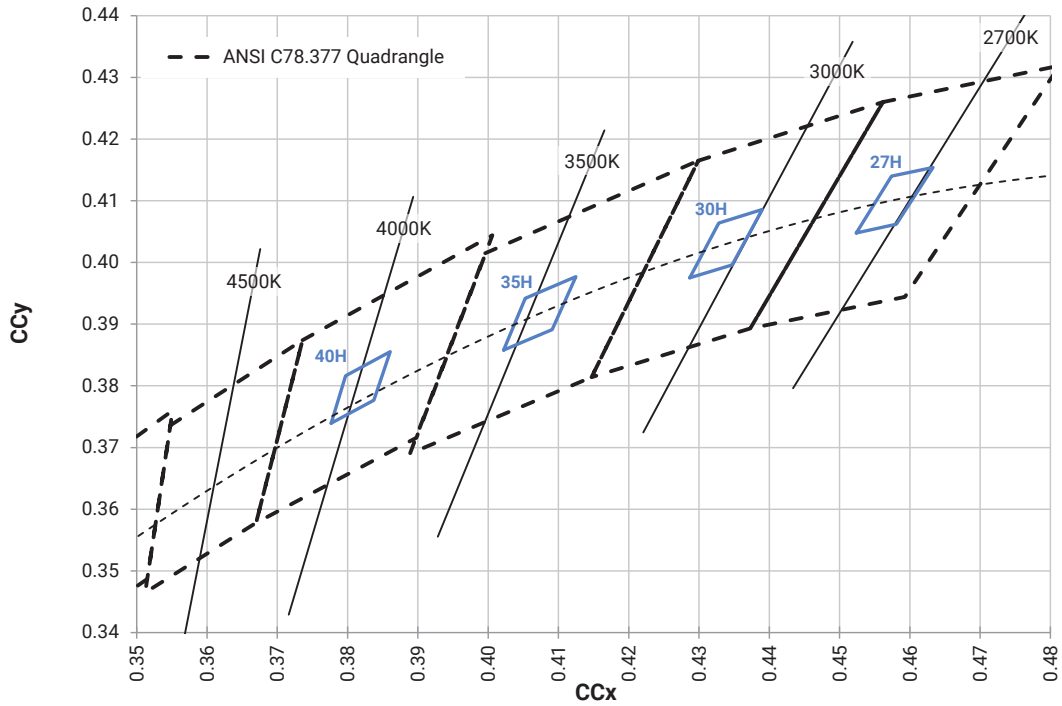

PREMIUM COLOR BINS PLOTTED ON THE 1931 CIE COLOR SPACE ($T_j = 85\text{ }^\circ\text{C}$) - CONTINUED

Speciality (2-step)

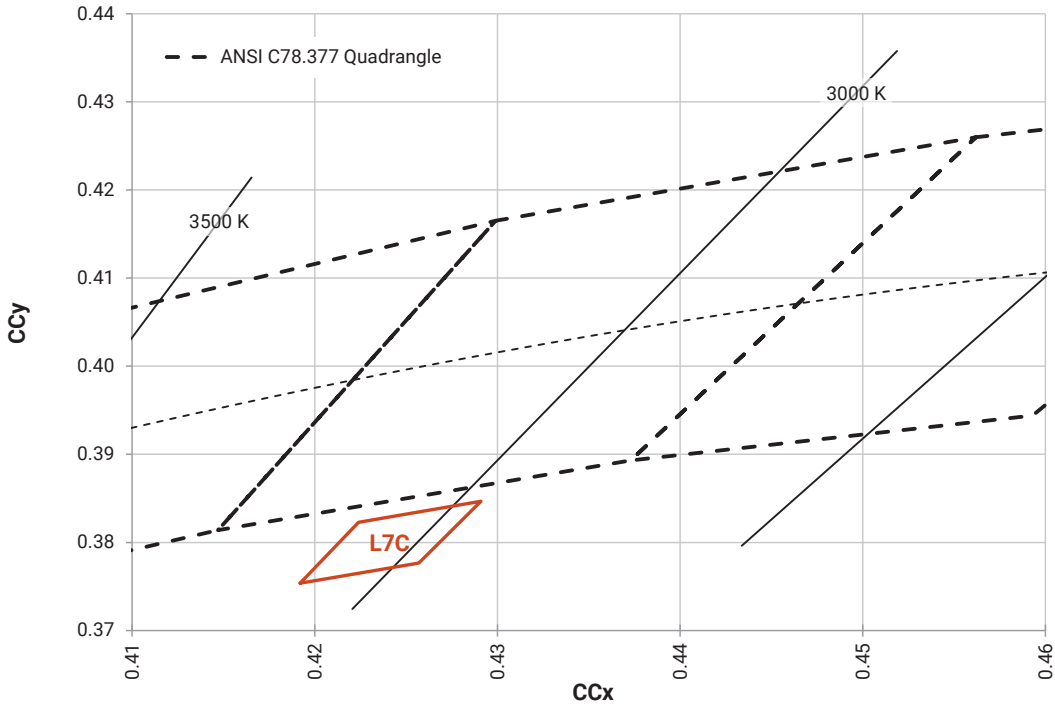

Speciality (3-step)

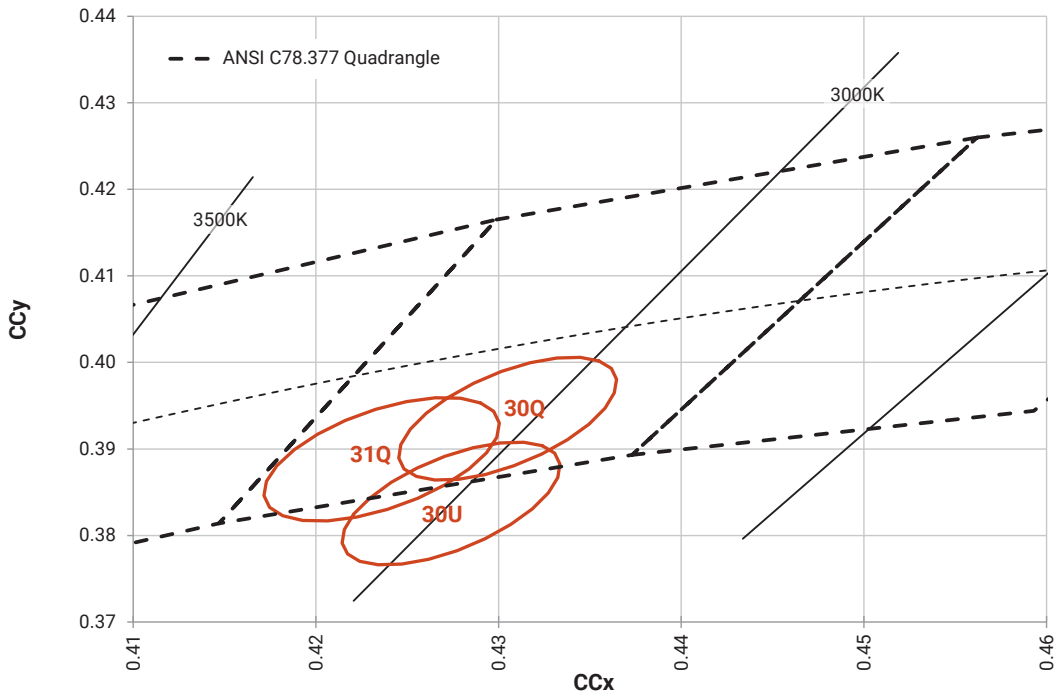

BIN AND ORDER CODE FORMATS

Bin codes and order codes are configured as follows:

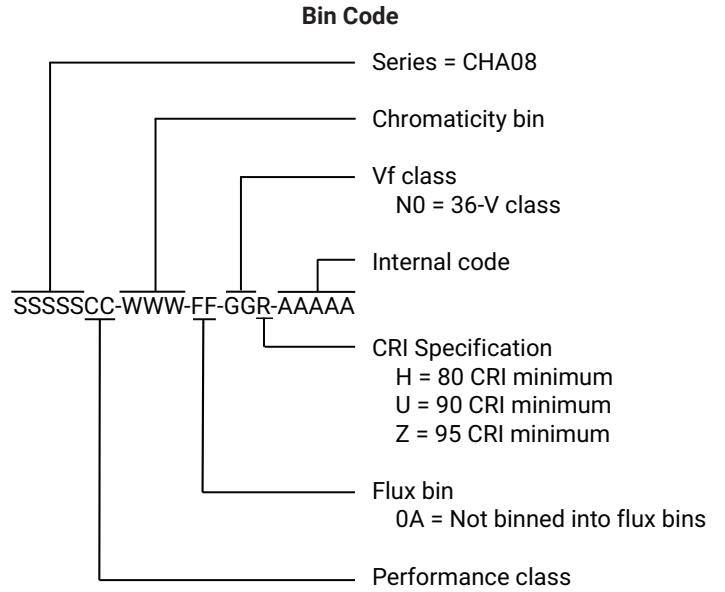
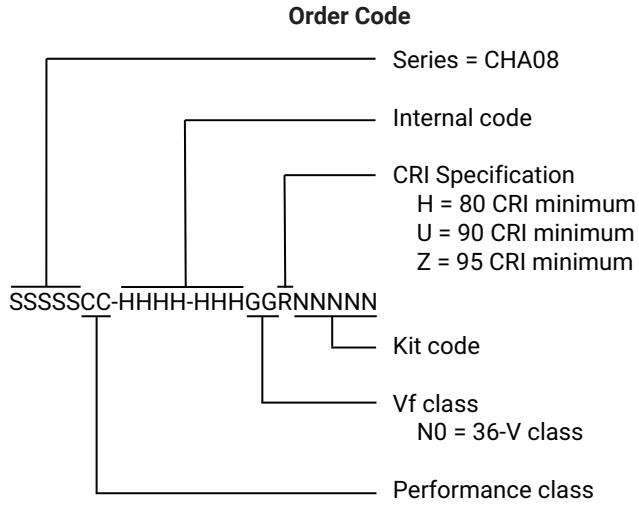

MECHANICAL DIMENSIONS

Dimensions are in mm.

Tolerances unless otherwise specified: $\pm .13$

$x^\circ \pm 1^\circ$

Meaning of LED marking

A0825N = 36-V CHA0825

$X_1 X_2 X_3 X_4 X_5$

X1 CCT

5 = 4000 K

6 = 3500 K

7 = 3000 K

8 = 2700 K

X2

M = EasyWhite LED on the black-body line

Q = Specialty LED below the black-body line

U = Specialty LED below the black-body line

X3 Flux bin

X4

0A = Not binned into flux bins

X5 CRI

H = 80 CRI min

U = 90 CRI min

Z = 95 CRI min

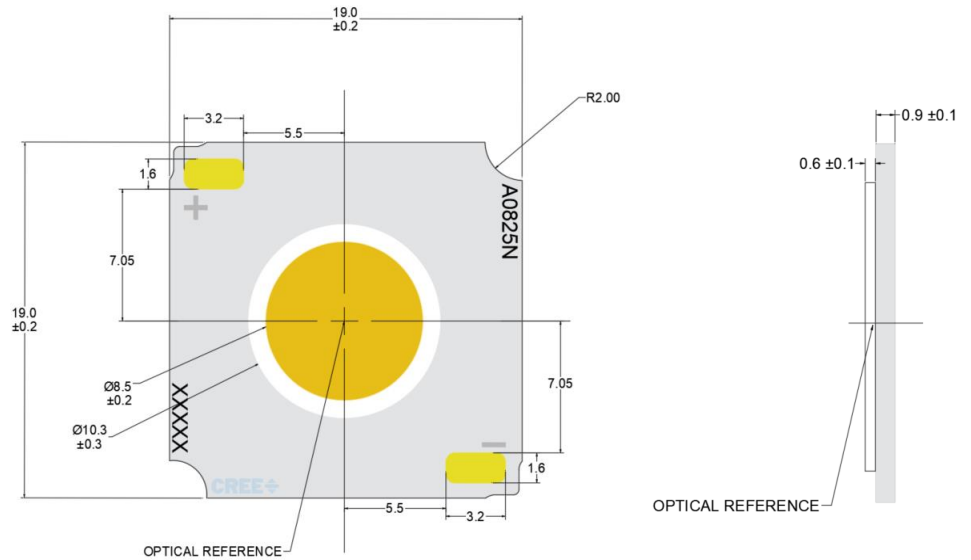

To assist in identifying the LED, CHA0825 LEDs provide a 2D barcode, positioned on the back of the LED, as shown in the following diagram. For a complete description of the bar code format, please refer to the [XLamp CHA Family LEDs soldering and handling document](#).

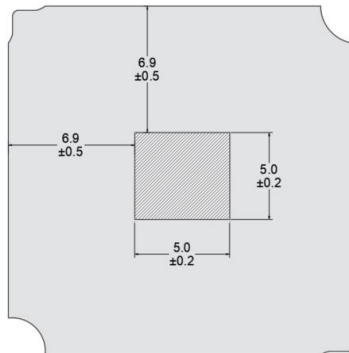

Tc measurement point: either the anode or cathode solder pad

THERMAL DESIGN

The CHA family of LED arrays can include over a hundred different LED die inside one package, and thus over a hundred different junction temperatures (T_j). Cree LED has intentionally removed junction-temperature-based operating limits and replaced the commonplace maximum T_j calculations with maximum ratings based on forward current (I_f) and case temperature (T_c). No additional calculations are required to ensure the CHA LED is being operated within its designed limits. LES temperature measurement provides additional verification of good thermal design. Please refer to page 2 for the Operating Limits specification.

There is no need to calculate for T_j inside the package, as the thermal management design process, specifically from solder point (T_{sp}) to ambient (T_a), remains identical to any other LED component. For more information on thermal management of XLamp LEDs, please refer to the [Thermal Management application note](#). For CHA soldering recommendations and more information on thermal interface materials (TIM), LES temperature measurement, and connection methods, please refer to the [XLamp CHA Family LEDs soldering and handling document](#).

To keep the CHA0825 LED at or below the maximum rated T_c , the case to ambient temperature thermal resistance (R_{c-a}) must be at or below the maximum R_{c-a} value shown on the following graph, depending on the operating environment. The y-axis in the graph is a base 10 logarithmic scale.

As the figure at right shows, the R_{c-a} value is the sum of the thermal resistance of the TIM (R_{tim}) plus the thermal resistance of the heat sink (R_{hs}).

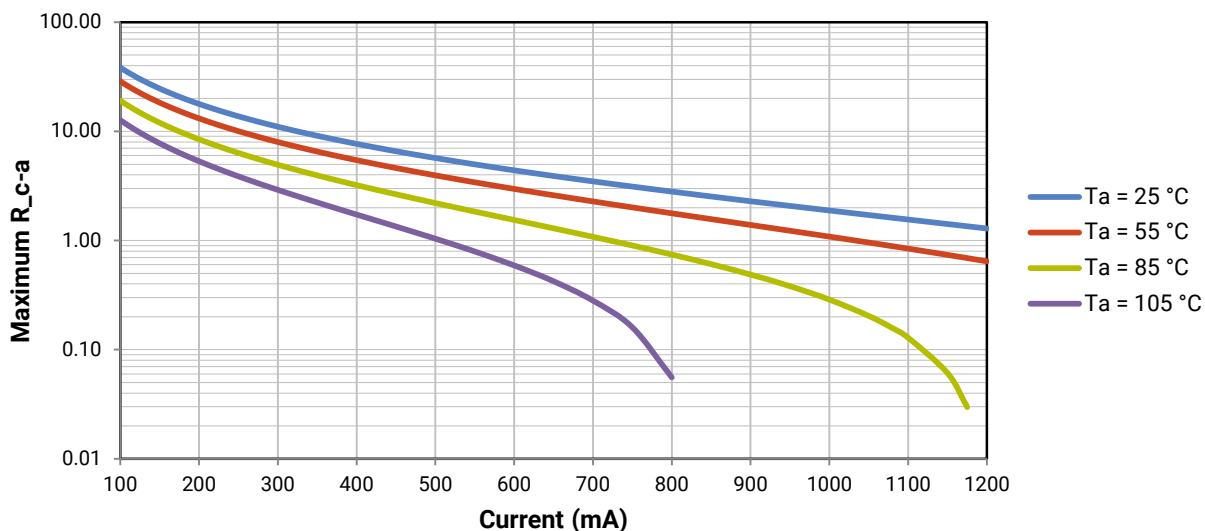
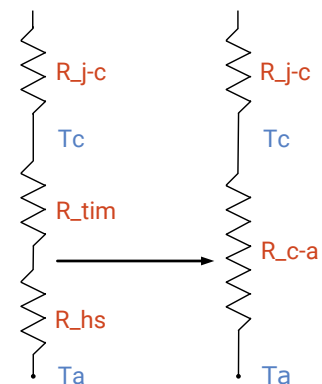

NOTES

Measurements

The luminous flux, radiant power, chromaticity, forward voltage and CRI measurements in this document are binning specifications only and solely represent product measurements as of the date of shipment. These measurements will change over time based on a number of factors that are not within Cree LED's control and are not intended or provided as operational specifications for the products. Calculated values are provided for informational purposes only and are not intended or provided as specifications.

Pre-Release Qualification Testing

Please read the [LED Reliability Overview](#) for details of the qualification process Cree LED applies to ensure long-term reliability for XLamp LEDs and details of Cree LED's pre-release qualification testing for XLamp LEDs. Cree LED did not perform Room Temperature Operating Life (RTOL) testing on the CHA0825 LED.

Lumen Maintenance

Cree LED now uses standardized IES LM-80-08 and TM-21-11 methods for collecting long-term data and extrapolating LED lumen maintenance. For information on the specific LM-80 data sets available for this LED, refer to the public [LM-80 results document](#).

Please read the [Long-Term Lumen Maintenance application note](#) for more details on Cree LED's lumen maintenance testing and forecasting. Please read the [Thermal Management application note](#) for details on how thermal design, ambient temperature, and drive current affect the LED junction temperature.

Vision Advisory

WARNING: Do not look at an exposed lamp in operation. Eye injury can result. For more information about LEDs and eye safety, please refer to the [LED Eye Safety application note](#).

RoHS Compliance

The levels of RoHS restricted materials in this product are below the maximum concentration values (also referred to as the threshold limits) permitted for such substances, or are used in an exempted application, in accordance with EU Directive 2011/65/EC (RoHS2), as implemented January 2, 2013. RoHS Declarations for this product can be obtained from your Cree LED representative or from the [Product Ecology](#) section of the Cree LED website.

REACH Compliance

REACH substances of very high concern (SVHCs) information is available for this product. Since the European Chemical Agency (ECHA) has published notice of their intent to frequently revise the SVHC listing for the foreseeable future, please contact a Cree LED representative to insure you get the most up-to-date REACH SVHC Declaration. REACH banned substance information (REACH Article 67) is also available upon request.

UL® Recognized Component

This product meets the requirements to be considered a UL Recognized Component with Level 4 enclosure consideration. The LED package or a portion thereof has been investigated as a fire and electrical enclosure per ANSI/UL 8750.

PACKAGING

CHA0825 LEDs are packaged in trays of 45. Five trays are sealed in an anti-static bag and placed inside an inner box, for a total of 225 LEDs per box. Each box contains LEDs from the same performance bin. Eight boxes are placed inside a carton, for a total of 1,800 LEDs per carton.

Dimensions are in mm.

Tolerances: ± 0.5 mm

Load Tray

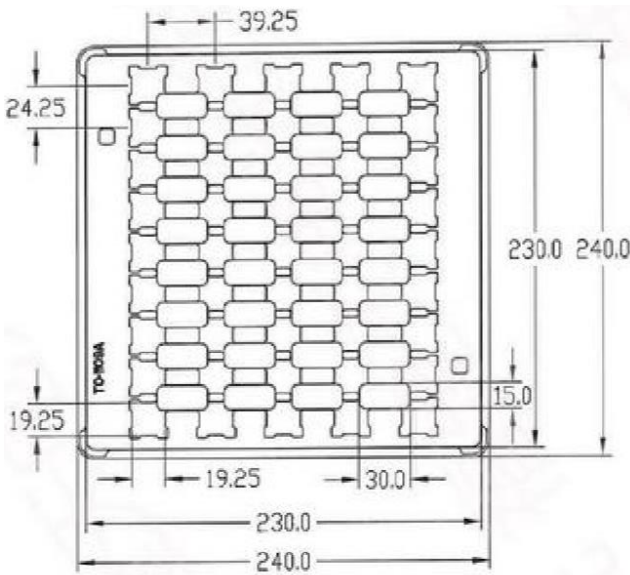

Upper Tray

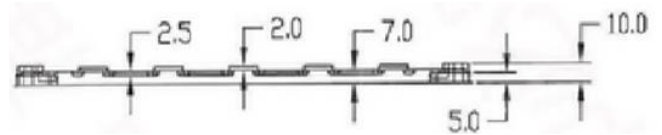
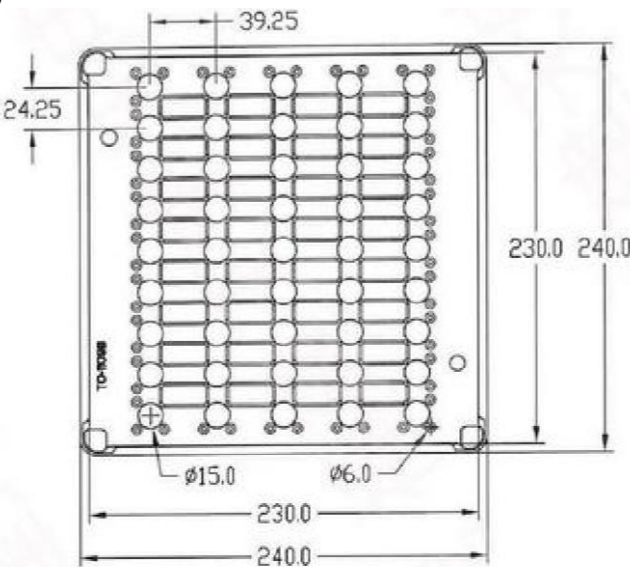

PACKAGING - CONTINUED

CHA0825 LEDs are packaged in trays of 45. Five trays are sealed in an anti-static bag and placed inside an inner box, for a total of 225 LEDs per box. Each box contains LEDs from the same performance bin. Eight boxes are placed inside a carton, for a total of 1,800 LEDs per carton.

Dimensions are in mm.
Tolerances: ± 3 mm

Inner Box

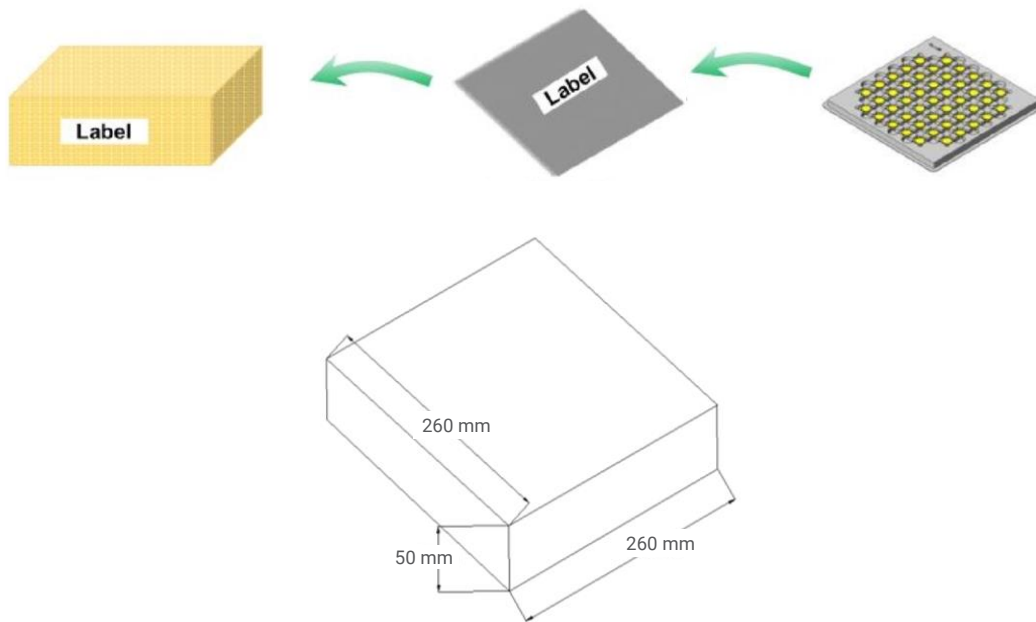

Outer Carton

