

Data sheet | Item number: 769-109/000-039

1-conductor female connector; CAGE CLAMP®; 4 mm²; Pin spacing 5 mm; 9-pole; coding finger; 4,00 mm²; gray/blue/green-yellow

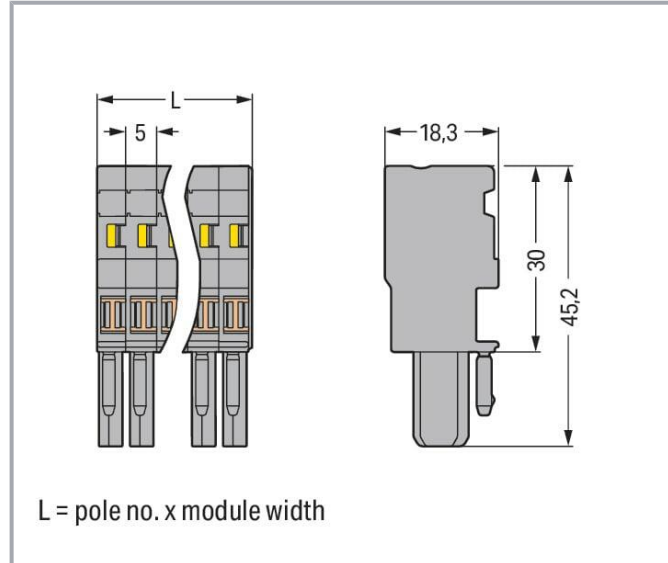

www.wago.com/769-109/000-039

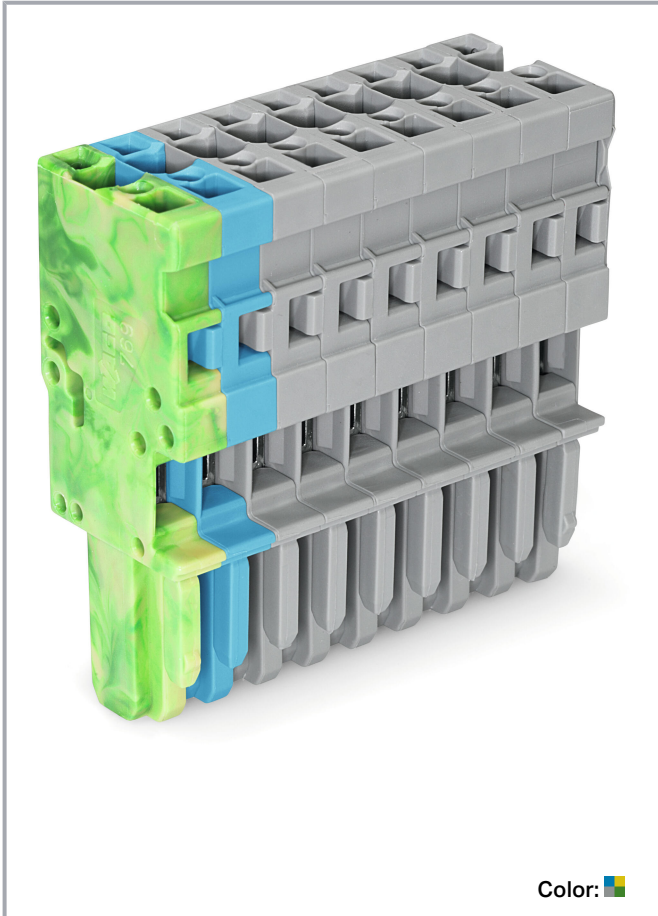

**Data
Notes**

Safety information

According to EN 61984, pluggable connectors without current interrupting capacity must not be mated or unmated when live or under load.

Electrical data

Subject to changes. Please also observe the further product documentation!

WAGO GmbH & Co. KG
Hansastr. 27
32423 Minden
Phone: +49571 887-0 | Fax: +49571 887-169
Email: info.de@wago.com | Web: www.wago.com

Do you have any questions about our products?
We are always happy to take your call at +49 (571) 887-44222.



Ratings per IEC/EN

| | |
|-------------------------------|---|
| Ratings per | IEC/EN 61984 |
| Nominal voltage (III/3) | 500 V |
| Rated impulse voltage (III/3) | 6 kV |
| Rated current | 32 A |
| Legend (ratings) | (III / 3) ≙ Overvoltage category III / Pollution degree 3 |

Connection data

| | |
|----------------------------|---|
| Connection points | 9 |
| Total number of potentials | 9 |

Connection 1

| | |
|---------------------------------|--|
| Connection technology | CAGE CLAMP® |
| Actuation type | Operating tool |
| Connectable conductor materials | Copper |
| Nominal cross-section | 4 mm ² / 12 AWG |
| Solid conductor | 0.08 ... 4 mm ² / 28 ... 12 AWG |
| Fine-stranded conductor | 0.08 ... 4 mm ² / 28 ... 12 AWG |
| Strip length | 8 ... 9 mm / 0.31 ... 0.35 inches |
| Pole number | 9 |
| Wiring direction | Front-entry wiring |

Physical data

| | |
|--------------|-----------------------|
| Width | 45 mm / 1.772 inches |
| Height | 45.2 mm / 1.78 inches |
| Depth | 18.3 mm / 0.72 inches |
| Module width | 5 mm / 0.197 inches |

Mechanical Data

| | |
|--|--------------|
| Variable coding | Yes |
| Direct ground contact to DIN-rail/drilled hole/housing | No |
| Marking level | Side marking |
| Anti-rotation protection | Yes |

Subject to changes. Please also observe the further product documentation!

WAGO GmbH & Co. KG
 Hansastr. 27
 32423 Minden
 Phone: +49571 887-0 | Fax: +49571 887-169
 Email: info.de@wago.com | Web: www.wago.com

Do you have any questions about our products?
 We are always happy to take your call at +49 (571) 887-44222.



Plug-in connection

| | |
|--------------------------------------|-------------------------|
| Contact type (pluggable connector) | Female connector/socket |
| Connector (connection type) | for conductor |
| Mismatching protection | No |
| Plugging without loss of pin spacing | Yes |

Material Data

| | |
|-----------------------------|--|
| Note (material data) | Information on material specifications can be found here |
| Color | gray/blue/green-yellow |
| Material group | I |
| Insulation material | Polyamide (PA66) |
| Flammability class per UL94 | V0 |
| Fire load | 0.561 MJ |
| Halogen-free | Yes |
| Weight | 29.1 g |

Environmental requirements

| | |
|----------------------------------|-----------------|
| Processing temperature | -35 ... +85 °C |
| Continuous operating temperature | -60 ... +105 °C |

Commercial data

| | |
|-----------------------|---------------|
| eCl@ss 10.0 | 27-14-11-06 |
| eCl@ss 9.0 | 27-14-11-06 |
| ETIM 8.0 | EC001284 |
| ETIM 7.0 | EC001284 |
| PU (SPU) | 25 pcs |
| Packaging type | box |
| Country of origin | DE |
| GTIN | 4050821653493 |
| Customs tariff number | 85366990990 |



Environmental Product Compliance

| | |
|------------------------|-------------------------|
| RoHS Compliance Status | Compliant, No Exemption |
|------------------------|-------------------------|

Subject to changes. Please also observe the further product documentation!

Approvals / Certificates

General approvals







| Logo | Approval | Additional Approval Text | Certificate name |
|--|--------------------------------------|--------------------------|------------------|
|  | CSA DEKRA Certification B.V. | C22.2 No. 158 | 1101144 |
|  | UL Underwriters Laboratories Inc. | UL 1977 | E 45171 |
|  | UR Underwriters Laboratories Inc. | UL 1059 | E45172 |

Optional accessories













Cover

| Cover | | |
|--|--|--|
|  | Item no.: 769-436 Jumper cover; for 1-conductor female plugs; for 5 poles; gray | www.wago.com/769-436 |

Ferrule

| Ferrule | | |
|---|---|--|
|  | Item no.: 216-101 Ferrule; Sleeve for 0.5 mm ² / AWG 22; uninsulated; electro-tin plated; silver-colored | www.wago.com/216-101 |
|  | Item no.: 216-104 Ferrule; Sleeve for 1.5 mm ² / AWG 16; uninsulated; electro-tin plated; silver-colored | www.wago.com/216-104 |
|  | Item no.: 216-102 Ferrule; Sleeve for 0.75 mm ² / AWG 20; uninsulated; electro-tin plated; silver-colored | www.wago.com/216-102 |
|  | Item no.: 216-103 Ferrule; Sleeve for 1 mm ² / AWG 18; uninsulated; electro-tin plated | www.wago.com/216-103 |
|  | Item no.: 216-203 Ferrule; Sleeve for 1 mm ² / AWG 18; insulated; electro-tin plated; red | www.wago.com/216-203 |
|  | Item no.: 216-206 Ferrule; Sleeve for 2.5 mm ² / AWG 14; insulated; electro-tin plated; blue | www.wago.com/216-206 |
|  | Item no.: 216-202 Ferrule; Sleeve for 0.75 mm ² / 18 AWG; insulated; electro-tin plated; gray | www.wago.com/216-202 |

Subject to changes. Please also observe the further product documentation!

| | | |
|--|---|--|
|  | Item no.: 216-204 Ferrule; Sleeve for 1.5 mm ² / AWG 16; insulated; electro-tin plated; black | www.wago.com/216-204 |
|  | Item no.: 216-201 Ferrule; Sleeve for 0.5 mm ² / 20 AWG; insulated; electro-tin plated; white | www.wago.com/216-201 |
|  | Item no.: 216-301 Ferrule; Sleeve for 0.25 mm ² / AWG 24; insulated; electro-tin plated; yellow | www.wago.com/216-301 |
|  | Item no.: 216-302 Ferrule; Sleeve for 0.34 mm ² / 22 AWG; insulated; electro-tin plated; light turquoise | www.wago.com/216-302 |
| Testing and measuring | | |
| Testing accessories | | |
|  | Item no.: 210-136 Test plug; 2 mm Ø; with 500 mm cable; red | www.wago.com/210-136 |
| Locking levers | | |
| Locking system | | |
|  | Item no.: 769-430 Locking lever; for female connectors; 1 part; Pin spacing 5 mm; 2-pole; gray | www.wago.com/769-430 |
|  | Item no.: 769-431 Locking lever; for female connectors; 1 part; Pin spacing 5 mm; 2-pole; orange | www.wago.com/769-431 |
| Strain relief | | |
| Strain relief | | |
|  | Item no.: 769-1609 Strain relief housing; for female and male connectors; 2 parts; Pin spacing 5 mm; 9-pole; gray | www.wago.com/769-1609 |
|  | Item no.: 769-413 Strain relief plate; for female and male connectors; 1 part; Pin spacing 5 mm; 6- to 9-pole; gray | www.wago.com/769-413 |
| Marking accessories | | |
| Marking strip | | |
|  | Item no.: 210-831 Marking strips; on reel; 2.3 mm wide; plain; Self-adhesive; white | www.wago.com/210-831 |
|  | Item no.: 210-834 Marking strips; on reel; 5 mm wide; plain; Self-adhesive; white | www.wago.com/210-834 |
|  | Item no.: 210-832 Marking strips; on reel; 3 mm wide; plain; Self-adhesive; white | www.wago.com/210-832 |
| Label | | |

Subject to changes. Please also observe the further product documentation!



Item no.: 210-805
Labels; for Smart Printer; permanent adhesive; 6 x 15 mm; white

www.wago.com/210-805



Item no.: 210-805/000-002
Labels; for Smart Printer; permanent adhesive; 6 x 15 mm; yellow

www.wago.com/210-805/000-002

Marker



Item no.: 2009-145
Mini-WSB Inline; for Smart Printer; 1700 pieces on roll; stretchable 5 - 5.2 mm; plain; snap-on type; white

www.wago.com/2009-145



Item no.: 248-501
Mini-WSB marking card; as card; not stretchable; plain; snap-on type; white

www.wago.com/248-501

Tool

Operating tool



Item no.: 210-490
Operating tool

www.wago.com/210-490



Item no.: 769-434
Operating tool; made of insulating material; 1-way; loose; white

www.wago.com/769-434

Jumpers

Jumper



Item no.: 769-402
Jumper; insulated; gray

www.wago.com/769-402

Protective warning marker

Cover



Item no.: 280-415
Protective warning marker; for 5 terminal blocks; with high-voltage symbol, black; yellow

www.wago.com/280-415

Insulation stop

Insulation stop



Item no.: 769-470
Insulation stop; 0.08 - 0.2 mm² "s" (0.14 mm² "f-st"); 5 pieces/strip; white

www.wago.com/769-470



Item no.: 769-471
Insulation stop; 0.25 - 0.5 mm²; 5 pieces/strip; light gray

www.wago.com/769-471



Item no.: 769-472
Insulation stop; 0.75 - 1 mm²; 5 pieces/strip; dark gray

www.wago.com/769-472

Subject to changes. Please also observe the further product documentation!



Downloads

Documentation

Bid Text

| | | | |
|--------------------------------|-------------|---------------|----------|
| 769-109/000-039 X81 - Datei | 2019 Feb 19 | xml 3.3 kB | Download |
|--------------------------------|-------------|---------------|----------|

| | | | |
|--------------------------------|------------|----------------|----------|
| 769-109/000-039 doc - Datei | 2017 Oct 4 | doc 26.6 kB | Download |
|--------------------------------|------------|----------------|----------|

Additional Information

| | | | |
|---|--|---------------|----------|
| Technical Section Technical explanations | | pdf 2.2 MB | Download |
|---|--|---------------|----------|

CAD/CAE-Data

CAE data

| | | | |
|-----------------------------------|--|-----|----------|
| EPLAN Data Portal 769-109/000-039 | | URL | Download |
|-----------------------------------|--|-----|----------|

| | | | |
|--------------------------------|--|-----|----------|
| WSCAD Universe 769-109/000-039 | | URL | Download |
|--------------------------------|--|-----|----------|

| | | | |
|-----------------------------------|--|-----|----------|
| EPLAN Data Portal 769-109/000-039 | | URL | Download |
|-----------------------------------|--|-----|----------|

| | | | |
|--------------------------------|--|-----|----------|
| WSCAD Universe 769-109/000-039 | | URL | Download |
|--------------------------------|--|-----|----------|

Environmental Product Compliance

Compliance Search

| | | | |
|--|--|-----|----------|
| Environmental Product Compliance 769-109/000-039 1-conductor female connector; CAGE CLAMP®; 4 mm ² ; Pin spacing 5 mm; 9-pole; coding finger; 4,00 mm ² ; gray/blue/green-yellow | | URL | Download |
|--|--|-----|----------|

Installation Notes

Conductor termination

Subject to changes. Please also observe the further product documentation!

WAGO GmbH & Co. KG
Hansastr. 27
32423 Minden
Phone: +49571 887-0 | Fax: +49571 887-169
Email: info.de@wago.com | Web: www.wago.com

Do you have any questions about our products?
We are always happy to take your call at +49 (571) 887-44222.

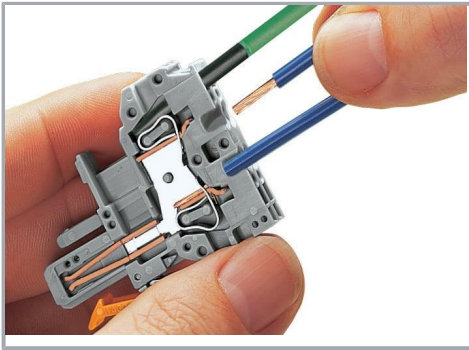

CAGE CLAMP® connection

Female plug: Inserting/removing a conductor via operating tool.

Operation 90° to conductor is also possible.

With ferruled conductors, it is necessary to use a terminal block one size smaller than the conductor's nominal cross-section.

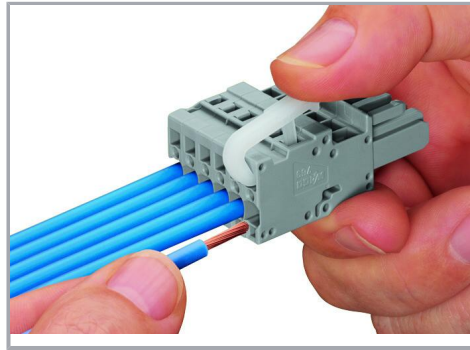

Operating lever

Inserting a conductor – side-entry wiring (example shows a female plug).

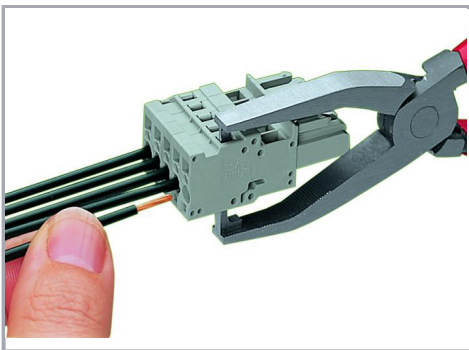

Operating tool

Inserting a conductor – side-entry wiring (example shows a female plug).

With ferruled conductors, it is necessary to use a terminal block one size smaller than the conductor's nominal cross-section.

Commoning

Subject to changes. Please also observe the further product documentation!

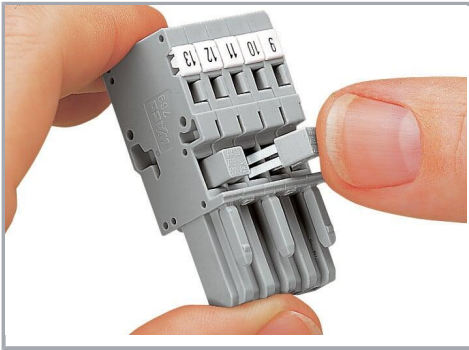

Commoning 1-conductor female plugs via miniature adjacent jumpers.

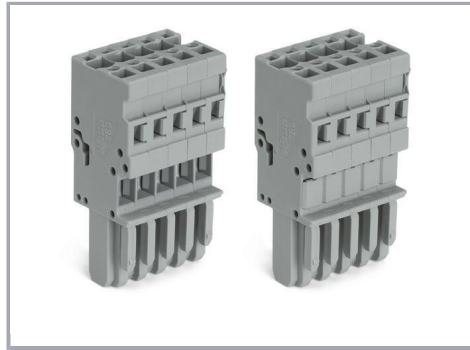

Jumper cover for 1-conductor female plugs

Coding



Coding a female plug by removing coding finger(s) via cutting tool. Do not remove the first and last coding fingers or use an additional locking lever.

Locking system

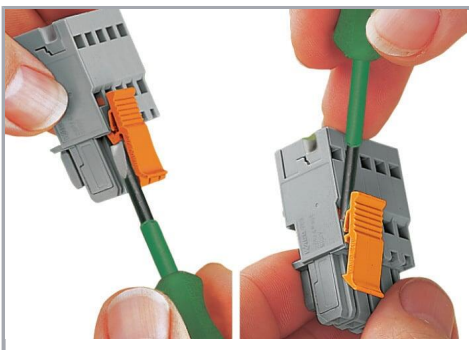

Locking/releasing a lever.

Subject to changes. Please also observe the further product documentation!

Strain relief

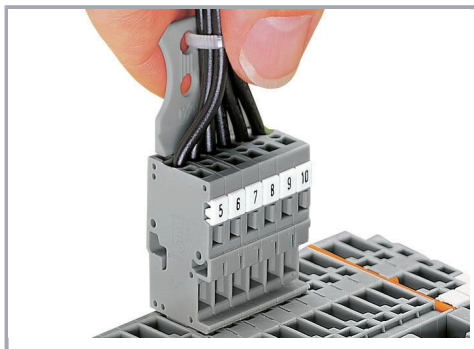

Removing a female plug via conductor bundle provided with strain relief plate.

Marking

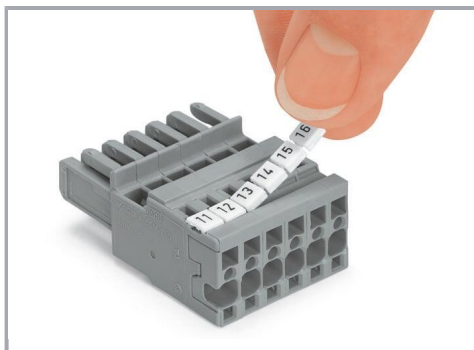

Labeling a female plug with CAGE CLAMP® connection via Mini-WSB Quick Markers.

Product family

X-COM

[Show all products from the family](#)

Subject to changes. Please also observe the further product documentation!