



Loadmonitors - GAMMA series

Underload monitoring

Fault latch

Recognition of disconnected consumers

Suitable for VFI (10 to 100Hz)

Supply voltage selectable via power modules / switching power supply

1 change-over contact

Width 22.5mm

Industrial design



Technical data

1. Functions

Underload monitoring ($\cos\varphi$) in 1- or 3-phase mains with adjustable threshold, fixed hysteresis, separately adjustable timing for start-up suppression and tripping delay and the following functions which are selected by means of rotary switch:

UNDER	Underload monitoring
UNDER+I<	Underload monitoring with recognition of disconnected consumers (Rel.OFF if I=0)
UNDER+LATCH	Underload monitoring with fault latch
UNDER+I<+LATCH	Underload monitoring with fault latch and recognition of disconnected consumers (Rel.OFF if I=0)

2. Time ranges

Start-up suppression time:	1s	100s
Tripping delay:	0.1s	40s

3. Indicators

Green LED ON:	indication of supply voltage
Green LED flashes:	indication of start-up suppression time
Yellow LED R ON/OFF:	indication of relay output
Yellow LED I=0 ON/OFF:	indication of disconnected consumers
Red LED ON/OFF:	indication of failure of the corresponding threshold
Red LED flashes:	indication of tripping delay of the corresponding threshold

4. Mechanical design

Self-extinguishing plastic housing, IP rating IP40
Mounted on DIN-Rail TS 35 according to EN 60715
Mounting position: any
Shockproof terminal connection according to VBG 4 (PZ1 required), IP rating IP20. Tightening torque: max. 1Nm
Terminal capacity:

1 x 0.5 to 2.5mm ²	with/without multicore cable end
1 x 4mm ²	without multicore cable end
2 x 0.5 to 1.5mm ²	with/without multicore cable end
2 x 2.5mm ² flexible	without multicore cable end

5. Input circuit

Supply voltage: terminals A1-A2 (galvanically separated)
12 to 400V a.c.
24V d.c.
Tolerance: selectable via power modules TR2 or via switching power supply SNT2 according to specification TR2 / SNT2
Rated frequency: according to specification TR2 / SNT2
Rated consumption: 2VA (1.5W)
Duration of operation: 100%
Reset time: 500ms
Residual ripple for d.c.: -
Drop-out voltage: >30% of the supply voltage
Overvoltage category: III (in accordance with IEC 60664-1)
Rated surge voltage: 4kV

6. Output circuit

1 potential free change-over contact
Rated voltage: 250V a.c.
Switching capacity: 750VA (3A / 250V a.c.)
If the distance between the devices is less than 5 mm.
Switching capacity: 1250VA (5A / 250V a.c.)
If the distance between the devices is greater than 5 mm.
Fusing: 5A fast acting
Mechanical life: 20 x 10⁶ operations
Electrical life: 2 x 10⁵ operations
at 1000VA resistive load
Switching frequency: max. 60/min at 100VA resistive load
max. 6/min at 1000VA resistive load (in accordance with IEC 60947-5-1)
Overvoltage category: III (in accordance with IEC 60664-1)
Rated surge voltage: 4kV

7. Measuring circuit

Measured variable: a.c. Sinus (10 to 100Hz)
Measuring-input voltage:
1-phase mains 40 to 415V a.c.
(max. 300V against ground)
terminals L1-L2/L3
3-phase mains 3~ 40/23 to 415/240V, terminals L1-L2-L3
Overload capacity:
1-phase mains 500V
3-phase mains 3~ 500/289V
Input resistance: ≥1MΩ
Measuring-input current: 0.5 to 10A, terminals L1-L1k
(for I>8A distance >5mm)
Overload capacity: 11A permanently
Input resistance: 5mΩ
Switching threshold $\cos\varphi$: 0.1 to 1.0
Hysteresis: fixed, approx. 3°
(equivalent to 3% at $\cos\varphi = 0.8$)
Overvoltage category: III (in accordance with IEC 60664-1)
Rated surge voltage: 4kV

8. Accuracy

Base accuracy: ±5% (equivalent to 5% at $\cos\varphi = 0.8$)
Frequency response: -
Adjustment accuracy: ≤5% (at $\cos\varphi = 0.8$)
Repetition accuracy: ±1.8° (equivalent to 1.8% at $\cos\varphi = 0.8$)
Voltage influence: -
Temperature influence: ≤0.1% / °C

9. Ambient conditions

Ambient temperature: -25 to +55°C (in accordance with IEC 60068-1)
-25 to +40°C (in accordance with UL 508)
Storage temperature: -25 to +70°C
Transport temperature: -25 to +70°C
Relative humidity: 15% to 85%
(in accordance with IEC 60721-3-3 class 3K3)
Pollution degree: 3 (in accordance with IEC 60664-1)
Vibration resistance: 10 to 55Hz 0.35mm
(in accordance with IEC 60068-2-6)
Shock resistance: 15g 11ms
(in accordance with IEC 60068-2-27)

Functions

When the supply voltage U is applied, the output relay switches into on-position (yellow LED R) and the set interval of the start-up suppression (START) begins (green LED U flashes). If the current doesn't flow during the start-up suppression the yellow LED I=0 is illuminated. Changes of the measured power factor ($\cos\phi$) during this period do not affect the state of the output relay. After the interval has expired the green LED is illuminated steadily.

Underload monitoring (UNDER, UNDER+LATCH)

When the measured power factor falls below the value adjusted at the MIN-regulator, the set interval of the tripping delay (DELAY) begins (red LED MIN flashes). After the interval has expired (red LED MIN illuminated), the output relay switches into off-position (yellow LED R not illuminated). The output relay again switches into on-position (yellow LED R illuminated), when the measured power factor exceeds the value adjusted at the MIN-regulator by more than the fixed hysteresis.

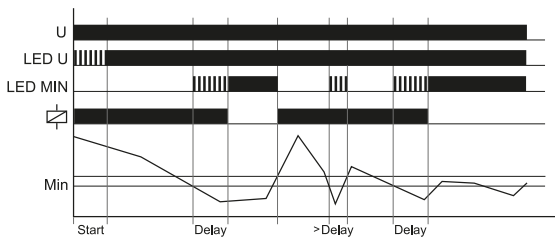

Underload monitoring with fault latch (UNDER+LATCH)

When the measured power factor falls below the value adjusted at the MIN-regulator, the set interval of the tripping delay (DELAY) begins (red LED MIN flashes). After the interval has expired (red LED MIN illuminated), the output relay switches into off-position (yellow LED R not illuminated). If the measured power factor exceeds the value adjusted at the MIN-regulator by more than the fixed hysteresis, the output relay stays in off-position.

After resetting the failure (interrupting and re-applying the supply voltage), the output relay switches into on-position and a new measuring cycle begins with the set interval of the start-up suppression.

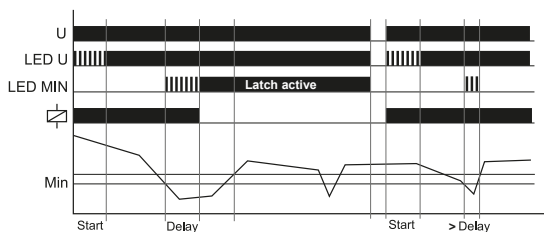

Recognition of disconnected consumers

Overview:

Function	U	$U + \bar{I}$	$U + \bar{I} + L$
Relay if I=0	ON	OFF	OFF
LED I=0 if I=0	ON	ON	ON
Fault latch	no	no	yes

When the current flow between i and k is interrupted and no fault has been stored, the output acts as shown in the table.

When the current flow is restored, the measuring cycle is restarted with the set interval of the start-up suppression.(START).

UNDER

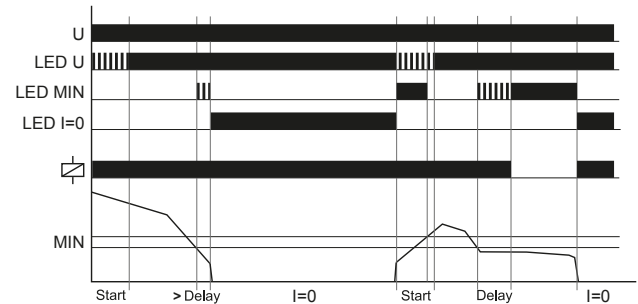

UNDER + \bar{I}

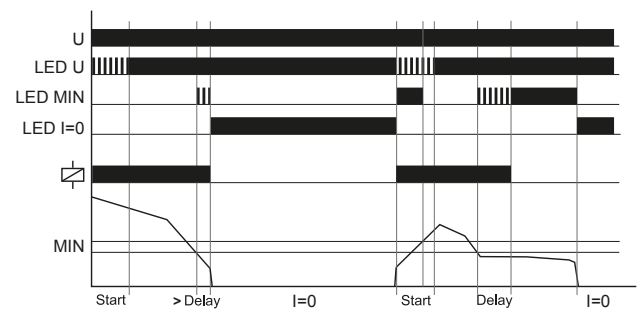

UNDER + \bar{I} + L

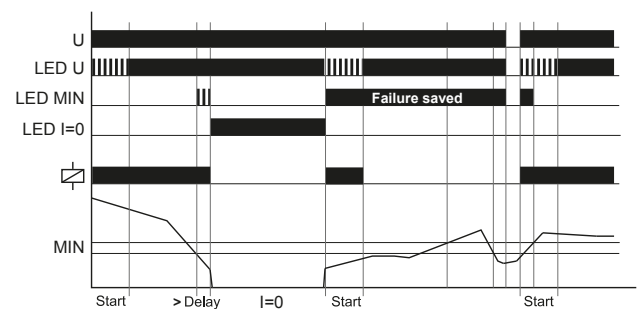

Fault latch (+LATCH)

If the fault latch is activated (+L), the recognition of disconnected consumers is not stored. The fault latch only stores failures of underload monitoring!

After the interval of the start-up suppression the output relay switches into on-position if the current flow is restored, the measured power factor remains above the set threshold and his hysteresis and no failure is stored.

Functions

Connected to 3~ 400V mains with power module 24V a.c. without fault latch $I_N < 10A$

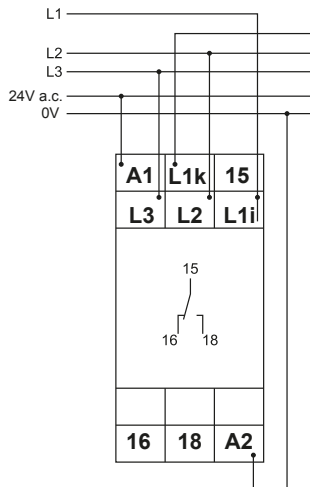

Connected to 1~ 230V mains with power module 230V a.c. without fault latch $I_N < 10A$

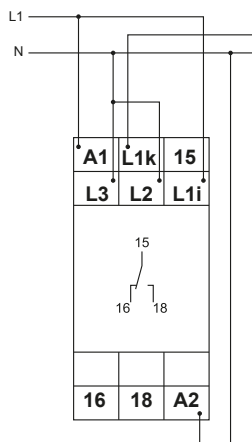

Connected to 3~ 400V mains with power module 400V a.c. and fault latch $I_N < 10A$

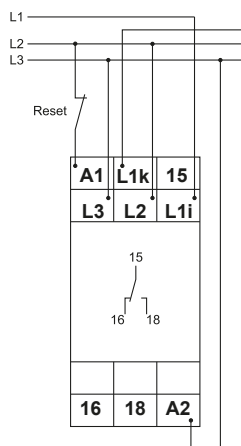

Connections

Connected to 3~ 400V mains with power module 400V a.c. and fault latch $I_N > 10A$

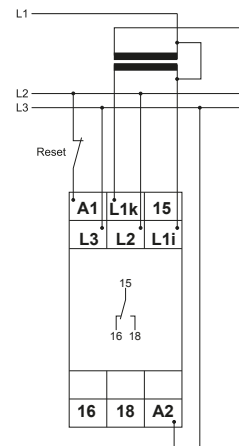

Dimensions

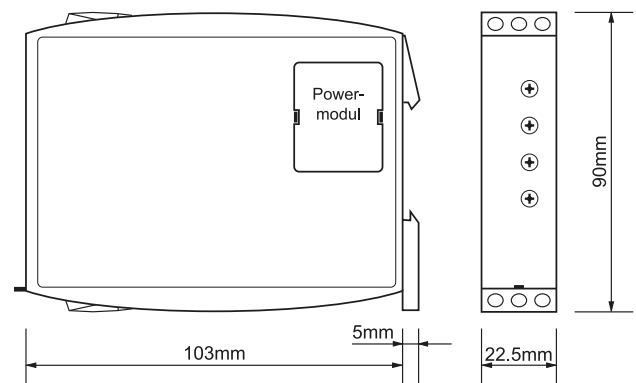

For your information:

Devices with batch number 205102 and below doesn't have an additional reversed recognition of disconnected consumers (+I_N). They recognize disconnected consumers always as „good“-state which means the output relay switches into on-position (LED I=0 illuminated) if the current flow is interrupted and no fault is stored.