



**SPECIFICATION SHEET**

<b>SPECIFICATION SHEET NO.</b>	Q0203- BW826M063HGKTA
<b>DATE</b>	Feb. 03, 2023
<b>REVISION</b>	A0
<b>DESCRIPTION</b>	<p>Conductive Polymer Hybrid Aluminum Electrolytic Capacitors BW series,            Capacitance: 82μF, Tolerance ±20%, Voltage 63V, 2 pads            Case size: ØD10*L10mm, Ripple Current 1400mA Max. @+125°C, 100KHz,            Lifetime 4000Hours @125°C, ESR @125°C,100KHz: 30 mohm Max.            Operating Temp. Range -55°C ~+125°C            Leakage Current: 51.7μA @at 20°C after 2 minutes            RoHS/RoHS III Compliant &amp; Halogen Free, Package in Tape/Reel</p>
<b>CUSTOMER</b>	
<b>CUSTOMER PART NUMBER</b>	
<b>CROSS REF. PART NUMBER</b>	
<b>ORIGINAL PART NUMBER</b>	Aillen CXE826M1JHBWG10TR
<b>PART CODE</b>	BW826M063HGKTA

<b>VENDOR APPROVE</b>			
Issued/Checked/Approved			
DATE: Feb.03, 2023			

<b>CUSTOMER APPROVE</b>	
DATE:	

**CONDUCTIVE POLYMER HYBRID ALUMINUM ELEC. CAPACITORS BW SERIES**

**MAIN FEATURE**

- Conductive Polymer Hybrid Aluminum Electrolytic Capacitors
- High Stability And Reliability, Low ESR, High Ripple Current
- Long Life 4000 Hours @ 125°C
- Quality and standard Meets IEC 60384-4 and AEC-Q200-REV D
- Applicable To Automatic Mounting Machine
- Cross Competitors PARTS GYA, HZC, ZC And HXC Series And More.
- RoHS III Complaint And Halogen Free



**APPLICATION**

- For Applications Automotive and more

**PART CODE GUIDE**

**RFQ**

Request For Quotation

BW	826	M	063	H	G	K	T	A
1	2	3	4	5	6	7	8	9

1) **BW**: Conductive Polymer Hybrid Aluminum Electrolytic Capacitors BW series, 2 Pads

2) **826**: Rated Capacitance Code, 105: 1.0µF; 225: 2.2µF; 335: 3.3µF; 475: 4.7µF; 106: 10µF; 226: 22µF; 276: 27µF; 336: 33µF; 476: 47µF; 566: 56µF; 686: 68µF; **826: 82µF**; 107: 100µF; 157: 150µF; 227: 220µF; 277: 270µF; 337: 330µF ; 477: 470µF

3) **M**: Capacitance tolerance code, **M: ±20%**; V: -10% ~ ±20%,

4) **063**: Rated Voltage Code, 016:16V; 025: 25V; 035: 35V; 050: 50V; **063: 63V**; 080: 80V

5) **H**: Environmental Requirements code, R: RoHS Complaint; **H: RoHS III Complaint & Halogen Free**

6) **G**: Aluminum Case size code, B: ØD3.0mm; C: ØD4.0mm; D: ØD5.0mm; E: ØD6.3mm; F: ØD8.0mm; **G: ØD10.0mm**; P: ØD12.5mm

7) **K**: Aluminum case Height code, H: L5.8mm; I: L6.5mm; J: L7.7mm; **K: L10.0mm**; L: L11.5mm; M: L12.5mm; N: L13.5mm

8) **T**: Package in Tape/Reel, 500pcs/Reel

9) **A**: Internal control or Customer's Special Code (A~Z or 1~9)

**CONDUCTIVE POLYMER HYBRID ALUMINUM ELEC. CAPACITORS BW SERIES**

Image For Reference



**BW Series**  
Case  $\phi D10.0 * L10.0$ mm  
Explosion Proof Value

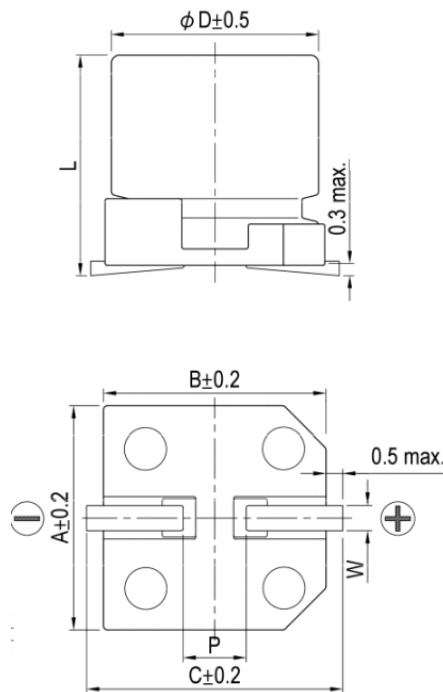

Symbol	Dimension (mm)
A	10.3
B	10.3
D	$\phi 10.0$
C	11.0
L	$10.0 \pm 0.5$
p	$4.7 \pm 0.2$
W	$0.70 \sim 1.3$

Marking

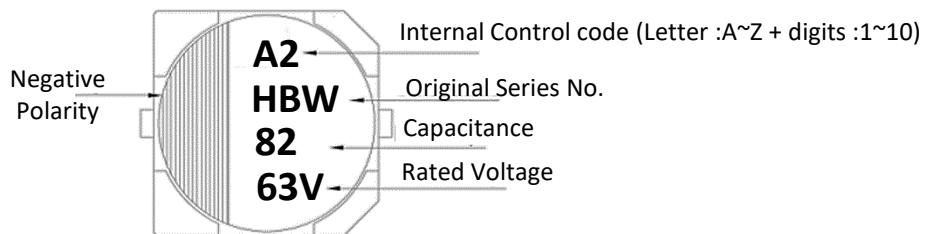

Recommended Pad Layout

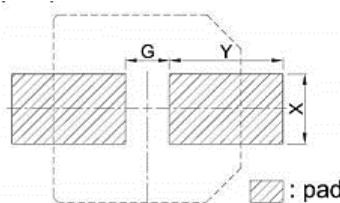

Symbol	Dimension
G	4.0
X	2.5
Y	4.0

**CONDUCTIVE POLYMER HYBRID ALUMINUM ELEC. CAPACITORS BW SERIES**

**CONSTRUCTION**

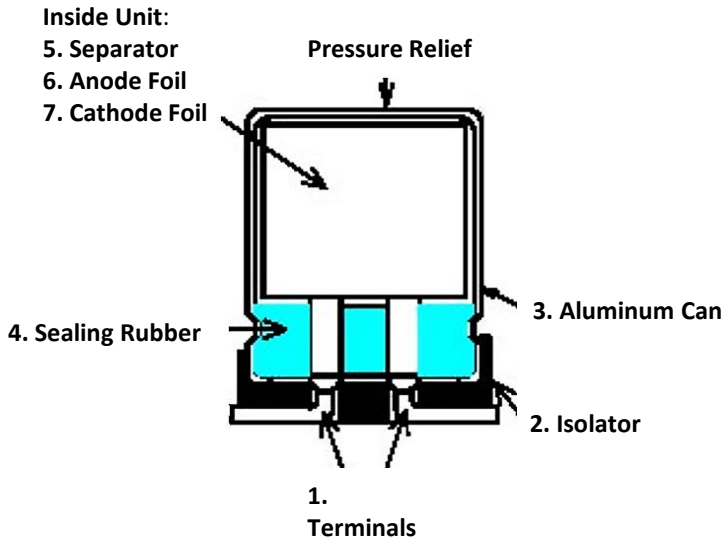

No.	Parts	Material
1	Terminal	High pure aluminum, lead is tin copper clad steel wire
2	Isolator	Thermo-plastic resin
3	Aluminum Can	High purity aluminum, coated aluminum can
4	Sealing Rubber	Rubber
5	Separator	Manila hemp
6	Anode Foil (+)	High pure aluminum formation foil
7	Cathode Foil (-)	High pure aluminum carbon foil

**CONDUCTIVE POLYMER HYBRID ALUMINUM ELEC. CAPACITORS BW SERIES**

**CHARACTERISTICS**

**Standard Atmospheric Conditions**

The standard range of atmospheric conditions for making measurements/test as follows:

Ambient temperature: 15 °C to 35 °C

Relative humidity: 45% to 75% ;

Air Pressure: 86kPa to 106kPa

If there is any doubt about the results, measurement shall be made within the following conditions:

Ambient temperature: 20 °C ± 2 °C

Relative humidity: 60% to 70%

Air Pressure: 86kPa to 106kPa

As to the detailed information, please refer to following Table

**Operating Temperature Range**

The ambient temperature range at which the capacitor can be operated continuously at rated voltage (16~80V) is -55 °C to 125 °C. As to the detailed information, please refer to following Table

**CONDUCTIVE POLYMER HYBRID ALUMINUM ELEC. CAPACITORS BW SERIES**
**SPECIFICATION**

PARAMETER	UNIT	VALUE	CONDITION				
Capacitance	μF	82	Product nominal capacity, test frequency: 120Hz,20°C within the specified capacity tolerance				
Capacitance Tolerance	%	+/-20					
Working Voltage	V	63	Rated working voltage				
Dissipation Factor	%	8.0	Also calls dissipation, test frequency: 120Hz				
Max ESR	mΩ	30	Equivalent series resistance, test frequency 100kHz				
Max Rated Ripple	mA rms	1400	The maximum allowable ripple current is 100kHz 125°C, the largest A.C current The DC voltage plus the peak AC voltage must not exceed the rated Voltage, and non-reverse charging				
			Frequency	120Hz≤ f<1KHz	1KHz≤ f <10KHz	10KHz≤ f<100KHz	100KHz≤ f<500KHz
			Coefficient	0.10	0.30	0.70	1.00
Leakage Current	μA	51.7	Leakage current, after charging for 2 minutes, test the leakage current value of product (20°C)				
Temperature Range	°C	-55~+125	/				
Temperature Characteristics, Impedance Ratio	Z-25°C/Z20°C≤1.5 At -25°C 100kHz (Low temperature)						
	Z-55°C/Z20°C≤2.0 At -55°C 100kHz (High temperature)						
Standards	AEC-Q200-REV D, IEC 60384-4						
Remarks	RoHS Compliance & Halogen-free						

**CONDUCTIVE POLYMER HYBRID ALUMINUM ELEC. CAPACITORS BW SERIES**

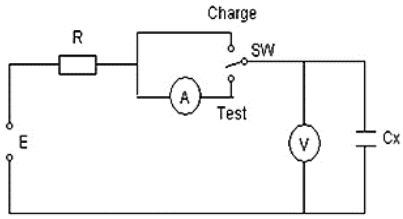
ITEM	PERFORMANCE														
Nominal Capacitance (Tolerance)	<p><b>&lt;Condition&gt;</b>            Measuring Frequency : 120Hz ± 12Hz            Measuring Voltage : Not more than 0.5V            Measuring Temperature : 20 ± 2°C</p> <p><b>&lt;Criteria&gt;</b>            Shall be within the specified capacitance tolerance</p>														
Leakage Current	<p><b>&lt;Condition&gt;</b>            After 2 minutes applications of rated working voltage at 20°C the rated working voltage shall be applied across the capacitor and its protective resistor which shall be 1000 ± 100Ω.</p> <div data-bbox="714 870 1113 1087" data-label="Diagram">  </div> <p><b>&lt;Criteria&gt;</b>            Remark: Refer to CASE SIZE &amp; MAX RIPPLE CURRENT List</p>														
Tanδ	<p><b>&lt;Condition&gt;</b>            See Normal Capacitance, for measuring frequency, voltage and temperature.</p> <p><b>&lt;Criteria&gt;</b>            The tangent of the loss angle (Tanδ) of the capacitors shall refer to the following table. Measurements shall be made under the same conditions as those given for the measurement of the capacitance.</p> <table border="1" data-bbox="425 1495 1300 1601"> <tbody> <tr> <td>W.V.</td> <td>16</td> <td>25</td> <td>35</td> <td>50</td> <td>63</td> <td>80</td> </tr> <tr> <td>Tanδ</td> <td>0.16</td> <td>0.14</td> <td>0.12</td> <td>0.10</td> <td>0.08</td> <td>0.08</td> </tr> </tbody> </table>	W.V.	16	25	35	50	63	80	Tanδ	0.16	0.14	0.12	0.10	0.08	0.08
W.V.	16	25	35	50	63	80									
Tanδ	0.16	0.14	0.12	0.10	0.08	0.08									
ESR Ripple Current	<p><b>ESR</b> :Equivalent series resistance, test frequency 100kHz</p> <p><b>Ripple Current</b> : The maximum allowable ripple current is 100kHz, the largest A.C current The DC voltage plus the peak AC voltage must not exceed the rated Voltage, and non-reverse charging.</p>														

**CONDUCTIVE POLYMER HYBRID ALUMINUM ELEC. CAPACITORS BW SERIES**

ITEM	PERFORMANCE																																															
<p>Characteristics At High And Low Temperature</p>	<p><b>&lt;Condition&gt;</b></p> <table border="1" data-bbox="425 437 1315 741"> <thead> <tr> <th>Step</th> <th>Testing Temperature(°C)</th> <th>Time (Min)</th> </tr> </thead> <tbody> <tr> <td>1</td> <td>20±2</td> <td>--</td> </tr> <tr> <td>2</td> <td>-25(-55)±3</td> <td>30</td> </tr> <tr> <td>3</td> <td>20±2</td> <td>10~15</td> </tr> <tr> <td>4</td> <td>125±2</td> <td>30</td> </tr> <tr> <td>5</td> <td>20±2</td> <td>10~15</td> </tr> </tbody> </table> <p><b>&lt;Criteria&gt;</b></p> <p>(1) Step.2 Impedance Ratio (at 100kHz)</p> <table border="1" data-bbox="425 864 1315 1050"> <thead> <tr> <th>WV(VDC)</th> <th>16</th> <th>25</th> <th>35</th> <th>50</th> <th>63</th> <th>80</th> </tr> </thead> <tbody> <tr> <td>Z(-25°C/Z(20°C)</td> <td>1.5</td> <td>1.5</td> <td>1.5</td> <td>1.5</td> <td>1.5</td> <td>1.5</td> </tr> <tr> <td>Z(-55°C/Z(20°C)</td> <td>2.0</td> <td>2.0</td> <td>2.0</td> <td>2.0</td> <td>2.0</td> <td>2.0</td> </tr> </tbody> </table> <p>(2) Step.4</p> <table border="1" data-bbox="425 1166 1315 1369"> <tbody> <tr> <td>Leakage current</td> <td>Not more than 800% of the specified value</td> </tr> <tr> <td>Capacitance Change</td> <td>Within ±10% of Step1 value.</td> </tr> <tr> <td>tan δ</td> <td>Not more than the specified value.</td> </tr> <tr> <td>Appearance</td> <td>There shall be no leakage of electrolyte.</td> </tr> </tbody> </table>	Step	Testing Temperature(°C)	Time (Min)	1	20±2	--	2	-25(-55)±3	30	3	20±2	10~15	4	125±2	30	5	20±2	10~15	WV(VDC)	16	25	35	50	63	80	Z(-25°C/Z(20°C)	1.5	1.5	1.5	1.5	1.5	1.5	Z(-55°C/Z(20°C)	2.0	2.0	2.0	2.0	2.0	2.0	Leakage current	Not more than 800% of the specified value	Capacitance Change	Within ±10% of Step1 value.	tan δ	Not more than the specified value.	Appearance	There shall be no leakage of electrolyte.
Step	Testing Temperature(°C)	Time (Min)																																														
1	20±2	--																																														
2	-25(-55)±3	30																																														
3	20±2	10~15																																														
4	125±2	30																																														
5	20±2	10~15																																														
WV(VDC)	16	25	35	50	63	80																																										
Z(-25°C/Z(20°C)	1.5	1.5	1.5	1.5	1.5	1.5																																										
Z(-55°C/Z(20°C)	2.0	2.0	2.0	2.0	2.0	2.0																																										
Leakage current	Not more than 800% of the specified value																																															
Capacitance Change	Within ±10% of Step1 value.																																															
tan δ	Not more than the specified value.																																															
Appearance	There shall be no leakage of electrolyte.																																															
<p>Terminal Strength</p>	<p><b>&lt;Condition&gt;</b></p> <p>Capacitor is placed in the PCB by solder paste and do high temperature test (Reflow)2 twice to endurance the power of 1.8kg for 60S,no dropping condition.</p> <p><b>&lt;Criteria&gt;</b></p> <table border="1" data-bbox="425 1694 1315 1897"> <tbody> <tr> <td>Leakage current</td> <td>Not more than the specified value</td> </tr> <tr> <td>Capacitance Change</td> <td>Within ±10% of initial value.</td> </tr> <tr> <td>tan δ</td> <td>Not more than the specified value.</td> </tr> <tr> <td>Appearance</td> <td>There shall be no leakage of electrolyte.</td> </tr> </tbody> </table>	Leakage current	Not more than the specified value	Capacitance Change	Within ±10% of initial value.	tan δ	Not more than the specified value.	Appearance	There shall be no leakage of electrolyte.																																							
Leakage current	Not more than the specified value																																															
Capacitance Change	Within ±10% of initial value.																																															
tan δ	Not more than the specified value.																																															
Appearance	There shall be no leakage of electrolyte.																																															



**CONDUCTIVE POLYMER HYBRID ALUMINUM ELEC. CAPACITORS BW SERIES**

ITEM	PERFORMANCE										
<p>Mechanical Shock</p>	<p><b>&lt;Condition&gt;</b></p> <p>Capacitor is placed in the PCB and fixed .Setting the acceleration (100g) and time (6ms) according to the test condition, shock 6 times from three directions (X-Y-Z).</p> <p><b>&lt;Criteria&gt;</b></p> <table border="1" data-bbox="425 631 1300 942"> <tr> <td>Leakage current</td> <td>Not more than the specified value</td> </tr> <tr> <td>Capacitance Change</td> <td>Within <math>\pm 10\%</math> of initial value.</td> </tr> <tr> <td>tan <math>\delta</math></td> <td>Not more than the specified value.</td> </tr> <tr> <td>ESR</td> <td>Not more than the specified value.</td> </tr> <tr> <td>Appearance</td> <td>There shall be no leakage of electrolyte.</td> </tr> </table>	Leakage current	Not more than the specified value	Capacitance Change	Within $\pm 10\%$ of initial value.	tan $\delta$	Not more than the specified value.	ESR	Not more than the specified value.	Appearance	There shall be no leakage of electrolyte.
Leakage current	Not more than the specified value										
Capacitance Change	Within $\pm 10\%$ of initial value.										
tan $\delta$	Not more than the specified value.										
ESR	Not more than the specified value.										
Appearance	There shall be no leakage of electrolyte.										
<p>Load Life Test</p>	<p><b>&lt;Condition&gt;</b></p> <ol style="list-style-type: none"> <li>Capacitors shall be placed in oven with application of rated ripple current for 4000 +72/-0hrs at 125°C.</li> <li>Then the capacitor shall be subjected to standard atmospheric conditions for 4 hours, after which measurements shall be made.</li> </ol> <p><b>&lt;Criteria&gt;</b></p> <p>The characteristic shall meet the following requirements.</p> <table border="1" data-bbox="425 1415 1285 1725"> <tr> <td>Leakage current</td> <td>Not more than the specified value</td> </tr> <tr> <td>Capacitance Change</td> <td>Within <math>\pm 30\%</math> of initial value.</td> </tr> <tr> <td>tan <math>\delta</math></td> <td>Not more than 200% of the specified value.</td> </tr> <tr> <td>ESR</td> <td>within <math>\pm 200\%</math> of the initial value</td> </tr> <tr> <td>Appearance</td> <td>There shall be no leakage of electrolyte.</td> </tr> </table>	Leakage current	Not more than the specified value	Capacitance Change	Within $\pm 30\%$ of initial value.	tan $\delta$	Not more than 200% of the specified value.	ESR	within $\pm 200\%$ of the initial value	Appearance	There shall be no leakage of electrolyte.
Leakage current	Not more than the specified value										
Capacitance Change	Within $\pm 30\%$ of initial value.										
tan $\delta$	Not more than 200% of the specified value.										
ESR	within $\pm 200\%$ of the initial value										
Appearance	There shall be no leakage of electrolyte.										

**CONDUCTIVE POLYMER HYBRID ALUMINUM ELEC. CAPACITORS BW SERIES**

ITEM	PERFORMANCE										
Shelf Life Test	<p><b>&lt;Condition&gt;</b>            After 1000 +48 / -0 hours test at 125°C without rated working voltage. And then the capacitor shall be subjected to standard atmospheric conditions for 4 hours, after which measurements shall be made.</p> <p><b>&lt;Criteria&gt;</b>            The characteristic shall meet the following requirements.</p> <table border="1" data-bbox="421 727 1268 1038"> <tbody> <tr> <td>Leakage current</td> <td>Not more than the specified value</td> </tr> <tr> <td>Capacitance Change</td> <td>Within <math>\pm 30\%</math> of initial value.</td> </tr> <tr> <td>tan <math>\delta</math></td> <td>Not more than 200% of the specified value.</td> </tr> <tr> <td>ESR</td> <td>within <math>\pm 200\%</math> of the initial value.</td> </tr> <tr> <td>Appearance</td> <td>There shall be no leakage of electrolyte.</td> </tr> </tbody> </table>	Leakage current	Not more than the specified value	Capacitance Change	Within $\pm 30\%$ of initial value.	tan $\delta$	Not more than 200% of the specified value.	ESR	within $\pm 200\%$ of the initial value.	Appearance	There shall be no leakage of electrolyte.
Leakage current	Not more than the specified value										
Capacitance Change	Within $\pm 30\%$ of initial value.										
tan $\delta$	Not more than 200% of the specified value.										
ESR	within $\pm 200\%$ of the initial value.										
Appearance	There shall be no leakage of electrolyte.										
Resistance To Solvents	<p><b>&lt;Condition&gt;</b>            Step 1:Put the capacitor into IPA(<math>25 \pm 5^\circ\text{C}</math>);            Step 2:the dipping time is <math>3+0.5/-0</math> minutes;            Step 3:Brush the capacitor for 10 times; Conduct the steps 1~3 for 3 cycles.</p> <p><b>&lt;Criteria&gt;</b>            The print cannot fall off or be obscure.</p>										

**CONDUCTIVE POLYMER HYBRID ALUMINUM ELEC. CAPACITORS BW SERIES**

ITEM	PERFORMANCE																						
Surge Voltage Test	<p><b>&lt;Condition&gt;</b></p> <p>The capacitor shall be subjected to 1000 cycles at 15 ~35°C. Protective series resistor a 1KΩ each consisting of a charge period of 30±5 seconds, followed by discharge period of approximately 5.5 minutes.</p> <p><b>&lt;Criteria&gt;</b></p> <table border="1" data-bbox="425 623 1272 872"> <tr> <td>Leakage current</td> <td>Not more than the specified value</td> </tr> <tr> <td>Capacitance Change</td> <td>Within ± 20% of initial value.</td> </tr> <tr> <td>tan δ</td> <td>Not more than the specified value.</td> </tr> <tr> <td>ESR</td> <td>within ± 200% of the initial value.</td> </tr> </table> <p>Surge voltage:</p> <table border="1" data-bbox="425 959 1272 1065"> <tr> <td>W.V.</td> <td>16</td> <td>25</td> <td>35</td> <td>50</td> <td>63</td> <td>80</td> </tr> <tr> <td>SV (V.DC)</td> <td>18.4</td> <td>28.8</td> <td>40.3</td> <td>57.5</td> <td>72.5</td> <td>92</td> </tr> </table>	Leakage current	Not more than the specified value	Capacitance Change	Within ± 20% of initial value.	tan δ	Not more than the specified value.	ESR	within ± 200% of the initial value.	W.V.	16	25	35	50	63	80	SV (V.DC)	18.4	28.8	40.3	57.5	72.5	92
Leakage current	Not more than the specified value																						
Capacitance Change	Within ± 20% of initial value.																						
tan δ	Not more than the specified value.																						
ESR	within ± 200% of the initial value.																						
W.V.	16	25	35	50	63	80																	
SV (V.DC)	18.4	28.8	40.3	57.5	72.5	92																	
Vibration Test	<p><b>&lt;Condition&gt;</b></p> <p>Capacitor is placed in the PCB and fixed by glue .Setting the acceleration (5g) and frequency (10- 2000Hz) according to the test condition ,vibration 4Hrs from three directions (X-Y-Z).</p> <p><b>&lt;Criteria&gt;</b></p> <table border="1" data-bbox="425 1373 1272 1893"> <tr> <td>Capacitance Change</td> <td>Within ± 10% of initial value.</td> </tr> <tr> <td>Leakage current</td> <td>Not more than the specified value.</td> </tr> <tr> <td>tan δ</td> <td>Not more than the specified value.</td> </tr> <tr> <td>ESR</td> <td>Not more than the specified value.</td> </tr> <tr> <td>Inner construction</td> <td>No intermittent contacts, open or short circuiting. No damage of tab terminals or electrodes.</td> </tr> <tr> <td>Appearance</td> <td>No mechanical damage in terminal. No leakage of electrolyte or swelling of the case. The markings shall be legible.</td> </tr> </table>	Capacitance Change	Within ± 10% of initial value.	Leakage current	Not more than the specified value.	tan δ	Not more than the specified value.	ESR	Not more than the specified value.	Inner construction	No intermittent contacts, open or short circuiting. No damage of tab terminals or electrodes.	Appearance	No mechanical damage in terminal. No leakage of electrolyte or swelling of the case. The markings shall be legible.										
Capacitance Change	Within ± 10% of initial value.																						
Leakage current	Not more than the specified value.																						
tan δ	Not more than the specified value.																						
ESR	Not more than the specified value.																						
Inner construction	No intermittent contacts, open or short circuiting. No damage of tab terminals or electrodes.																						
Appearance	No mechanical damage in terminal. No leakage of electrolyte or swelling of the case. The markings shall be legible.																						

**CONDUCTIVE POLYMER HYBRID ALUMINUM ELEC. CAPACITORS BW SERIES**

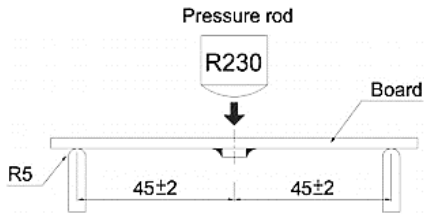
ITEM	PERFORMANCE										
Un-biased Humidity	<p><b>&lt;Condition&gt;</b></p> <p>Capacitors shall be exposed for 2000 +48/-0 hrs in an atmosphere of 85%±5% R.H. at 85±3°C. And then the capacitor shall be subjected to standard atmospheric conditions for 4 hours, after which measurements shall be made.</p> <p><b>&lt;Criteria&gt;</b></p> <table border="1" data-bbox="425 679 1272 988"> <tr> <td>Leakage current</td> <td>Not more than the specified value</td> </tr> <tr> <td>Capacitance Change</td> <td>Within ± 30% of initial value.</td> </tr> <tr> <td>tan δ</td> <td>Not more than 200% of the specified value.</td> </tr> <tr> <td>ESR</td> <td>Not more than 200% of the specified value.</td> </tr> <tr> <td>Appearance</td> <td>There shall be no leakage of electrolyte.</td> </tr> </table>	Leakage current	Not more than the specified value	Capacitance Change	Within ± 30% of initial value.	tan δ	Not more than 200% of the specified value.	ESR	Not more than 200% of the specified value.	Appearance	There shall be no leakage of electrolyte.
Leakage current	Not more than the specified value										
Capacitance Change	Within ± 30% of initial value.										
tan δ	Not more than 200% of the specified value.										
ESR	Not more than 200% of the specified value.										
Appearance	There shall be no leakage of electrolyte.										
Board Flex Test	<p><b>&lt;Condition&gt;</b></p> <p>Capacitor is placed in the PCB and pressed to deviate from Original fulcrum less than 2mm for 60 (+)s.</p>  <p><b>&lt;Criteria&gt;</b></p> <table border="1" data-bbox="425 1572 1272 1881"> <tr> <td>Leakage current</td> <td>Not more than the specified value.</td> </tr> <tr> <td>Capacitance Change</td> <td>Within ± 10% of initial value.</td> </tr> <tr> <td>tan δ</td> <td>Not more than the specified value.</td> </tr> <tr> <td>ESR</td> <td>Not more than the specified value.</td> </tr> <tr> <td>Appearance</td> <td>There shall be no leakage of electrolyte</td> </tr> </table>	Leakage current	Not more than the specified value.	Capacitance Change	Within ± 10% of initial value.	tan δ	Not more than the specified value.	ESR	Not more than the specified value.	Appearance	There shall be no leakage of electrolyte
Leakage current	Not more than the specified value.										
Capacitance Change	Within ± 10% of initial value.										
tan δ	Not more than the specified value.										
ESR	Not more than the specified value.										
Appearance	There shall be no leakage of electrolyte										

**CONDUCTIVE POLYMER HYBRID ALUMINUM ELEC. CAPACITORS BW SERIES**

ITEM	PERFORMANCE										
Biased Humidity Test	<p><b>&lt;Condition&gt;</b>            Capacitors shall be exposed for 2000 +48/-0 hrs in an atmosphere of 85% ± 5% R.H. at 85±3°C. And then the capacitor shall be subjected to standard atmospheric conditions for 4 hours, after which measurements shall be made.</p> <p><b>&lt;Criteria&gt;</b></p> <table border="1" data-bbox="411 636 1258 946"> <tr> <td>Leakage current</td> <td>Not more than the specified value</td> </tr> <tr> <td>Capacitance Change</td> <td>Within ± 30% of initial value.</td> </tr> <tr> <td>tan δ</td> <td>Not more than 200% of the specified value.</td> </tr> <tr> <td>ESR</td> <td>Not more than 200% of the specified value.</td> </tr> <tr> <td>Appearance</td> <td>There shall be no leakage of electrolyte.</td> </tr> </table>	Leakage current	Not more than the specified value	Capacitance Change	Within ± 30% of initial value.	tan δ	Not more than 200% of the specified value.	ESR	Not more than 200% of the specified value.	Appearance	There shall be no leakage of electrolyte.
Leakage current	Not more than the specified value										
Capacitance Change	Within ± 30% of initial value.										
tan δ	Not more than 200% of the specified value.										
ESR	Not more than 200% of the specified value.										
Appearance	There shall be no leakage of electrolyte.										
Electrical Characterization	<p><b>&lt;Condition&gt;</b>            Whether there is abnormality about electrical characterization in the test that under the endurance temperature (the lowest ,the highest, atmospheric temperature).</p> <p><b>&lt;Criteria&gt;</b>            Appearance: No abnormality</p>										
Rotational Temperature Test	<p><b>&lt;Condition&gt;</b>            Step1: Max. rated temperature ± 3°C (30mins)            Step2: Min. rated temperature ± 3°C (30mins) Max. transfer time: 1min According to the step 1 to step 2, and do 1000cycles.</p> <p><b>&lt;Criteria&gt;</b></p> <table border="1" data-bbox="411 1564 1258 1875"> <tr> <td>Leakage current</td> <td>Not more than the specified value</td> </tr> <tr> <td>Capacitance Change</td> <td>Within ± 20% of initial value.</td> </tr> <tr> <td>tan δ</td> <td>Not more than 200% of the specified value.</td> </tr> <tr> <td>ESR</td> <td>Not more than 200% of the specified value.</td> </tr> <tr> <td>Appearance</td> <td>There shall be no leakage of electrolyte.</td> </tr> </table>	Leakage current	Not more than the specified value	Capacitance Change	Within ± 20% of initial value.	tan δ	Not more than 200% of the specified value.	ESR	Not more than 200% of the specified value.	Appearance	There shall be no leakage of electrolyte.
Leakage current	Not more than the specified value										
Capacitance Change	Within ± 20% of initial value.										
tan δ	Not more than 200% of the specified value.										
ESR	Not more than 200% of the specified value.										
Appearance	There shall be no leakage of electrolyte.										

**CONDUCTIVE POLYMER HYBRID ALUMINUM ELEC. CAPACITORS BW SERIES**

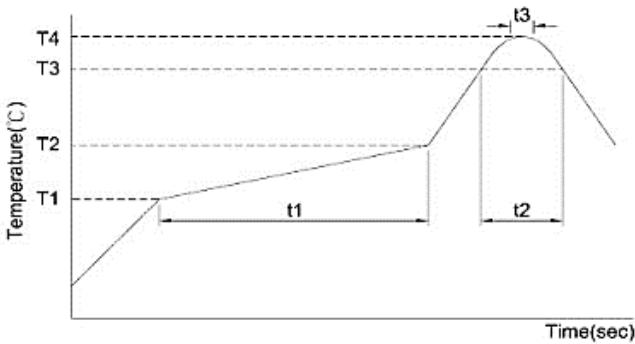
ITEM	PERFORMANCE																																										
Resistance to Soldering Heat test	<p><b>&lt;Condition&gt;</b> IR Reflow:</p>  <table border="1" data-bbox="442 839 1292 1274"> <tr> <td rowspan="2">Preheat</td> <td>Temperature (T1~T2°C)</td> <td colspan="3">150~180</td> </tr> <tr> <td>Time(t1) Max. s</td> <td colspan="3">120</td> </tr> <tr> <td rowspan="2">Duration</td> <td>Temperature (T3°C)</td> <td>200</td> <td>217</td> <td>230</td> </tr> <tr> <td>Time(t2) Max. s</td> <td>70</td> <td>50</td> <td>40</td> </tr> <tr> <td rowspan="2">Highest Temperatures</td> <td>Temperature (T4°C)</td> <td colspan="2">250</td> <td>260</td> </tr> <tr> <td>Time (t3) Max. s</td> <td colspan="3">5</td> </tr> <tr> <td colspan="2">The Number Of Reflow</td> <td colspan="2">2</td> <td>1</td> </tr> </table> <p>* Please contact our representative if your condition is higher.            * Please ensure that the capacitor became cold enough to the room temperature (5°C~ 35°C) before the second reflow.            * Consult with us when performing reflow profile in IPC / JEDEC (J-STD-020)</p> <p><b>&lt;Criteria&gt;</b> The characteristic shall meet the following requirement.</p> <table border="1" data-bbox="428 1585 1278 1895"> <tr> <td>Leakage current</td> <td>Not more than the specified value</td> </tr> <tr> <td>Capacitance Change</td> <td>Within <math>\pm 10\%</math> of initial value.</td> </tr> <tr> <td>tan <math>\delta</math></td> <td>Not more than the specified value.</td> </tr> <tr> <td>ESR</td> <td>Not more than the specified value.</td> </tr> <tr> <td>Appearance</td> <td>There shall be no leakage of electrolyte.</td> </tr> </table>	Preheat	Temperature (T1~T2°C)	150~180			Time(t1) Max. s	120			Duration	Temperature (T3°C)	200	217	230	Time(t2) Max. s	70	50	40	Highest Temperatures	Temperature (T4°C)	250		260	Time (t3) Max. s	5			The Number Of Reflow		2		1	Leakage current	Not more than the specified value	Capacitance Change	Within $\pm 10\%$ of initial value.	tan $\delta$	Not more than the specified value.	ESR	Not more than the specified value.	Appearance	There shall be no leakage of electrolyte.
Preheat	Temperature (T1~T2°C)		150~180																																								
	Time(t1) Max. s	120																																									
Duration	Temperature (T3°C)	200	217	230																																							
	Time(t2) Max. s	70	50	40																																							
Highest Temperatures	Temperature (T4°C)	250		260																																							
	Time (t3) Max. s	5																																									
The Number Of Reflow		2		1																																							
Leakage current	Not more than the specified value																																										
Capacitance Change	Within $\pm 10\%$ of initial value.																																										
tan $\delta$	Not more than the specified value.																																										
ESR	Not more than the specified value.																																										
Appearance	There shall be no leakage of electrolyte.																																										

**CONDUCTIVE POLYMER HYBRID ALUMINUM ELEC. CAPACITORS BW SERIES**

ITEM	PERFORMANCE		
Venting Test	<p><b>&lt;Condition&gt;</b></p> <ol style="list-style-type: none"> <li>1. Applicable to the capacitors with case size is 10φ mm and larger.</li> <li>2. Test condition: DC test: Applying inverse DC rated voltage with current to the capacitor.</li> </ol> <p>Where case diameter:</p> <p>φD ≤ 22.4mm: 1 A DC Max .</p> <p>φD &gt; 22.4mm: 10 A DC Max.</p> <p><b>&lt;Criteria&gt;</b></p> <ol style="list-style-type: none"> <li>1. When the pressure relief vent operated, the capacitor shall avoid any danger of fire or explosion of capacitor element (terminal and metal foil etc.) or cover.</li> <li>2. When the pressure relief device does not open with the voltage applied over 30 minutes, the test is considered to be passed.</li> </ol>		
Solderability Test	<p><b>&lt;Condition&gt;</b></p> <p>Solderability test 1:</p> <p>Pre-conditioning: execution according to RDD0302 (Solderability Test Method)</p> <p>Solder bath temperature: 235±5°C</p> <p>Duration: 5+0/-0.5s</p> <p>Solderability test 2:</p> <p>Pre-conditioning: execution according to RDD0302 (Solderability Test Method)</p> <p>Solder bath temperature: 215±3°C</p> <p>Duration: 5+0/-0.5s</p> <p>Solderability test 3: Pre-conditioning: execution according to RDD0302 (Solderability Test Method)</p> <p>Solder bath temperature: 260±5°C</p> <p>Duration: 7±0.5s</p> <p><b>&lt;Criteria&gt;</b></p> <table border="1" data-bbox="411 1638 1283 1701"> <tr> <td data-bbox="411 1638 739 1701">Coating quality</td> <td data-bbox="739 1638 1283 1701">Min. 95% of the surface being immersed</td> </tr> </table>	Coating quality	Min. 95% of the surface being immersed
Coating quality	Min. 95% of the surface being immersed		
Coating Case	<p>The color of coating case will turn light khaki from colorless with long duration in high temperature. Should there is any concern with the color changing of coating case, please consult with us</p>		

**CONDUCTIVE POLYMER HYBRID ALUMINUM ELEC. CAPACITORS BW SERIES**

**CASE SIZE & MAX RIPPLE CURRENT**

Rated Voltage V	Capacitance (+/-20%) μF	Case Size ØD*L mm	Dissipation Factor @+20°C, 120Hz Tanδ Max. %	Ripple Current @+125°C, 100KHz mA rms .	ESR (mΩ,20°C, 100kHz)	Leakage Current (μA/2min) μA Max.
63	82	10*10	8.0	1400	30	51.7

Remark:

- 1) Specification are subject to change without notice should a safety or technical concern arise regarding the product please be sure to contact our sales offices;
- 2)The sizes in the above table are all general specifications. If you need other specifications, please contact us.
- 3) Frequency Coefficient of Allowable Ripple Current:

Frequency	120Hz≤f<1KHz	1KHz≤f<10KHz	10KHz≤f<100KHz	100KHz≤f<500KHz
Coefficient	0.10	0.30	0.70	1.00



**CONDUCTIVE POLYMER HYBRID ALUMINUM ELEC. CAPACITORS BW SERIES**

**TAPE (Unit: mm), 500pcs/Reel,**

Applicable standard JIS C0806 and IEC 60286.

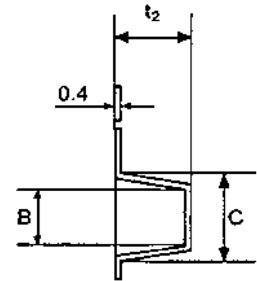
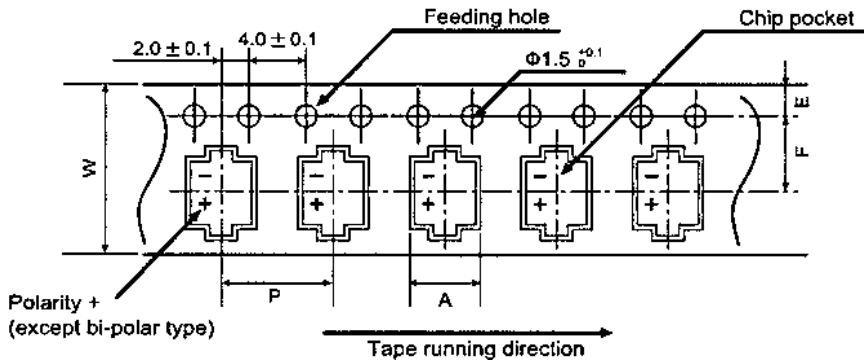

**REEL (Unit: mm)**

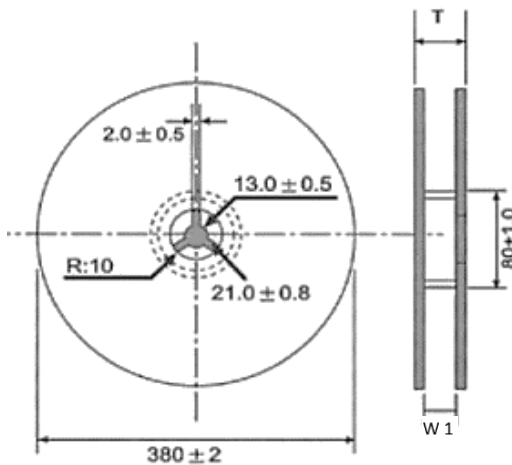

Case size: $\Phi D10.0 * L10.0$ mm	
Symbol	Dimension (mm)
A	$10.7 \pm 0.2$
B	$10.7 \pm 0.5$
C	$12.5 \pm 0.5$
W	$24.0 \pm 0.3$
F	$11.5 \pm 0.2$
E	$1.75 \pm 0.2$
P	$16.0 \pm 0.2$
t2	$11.0 \pm 0.5$
W1	$26.0 \pm 1.0$
T	$30.5 \pm 1.0$

**CONDUCTIVE POLYMER HYBRID ALUMINUM ELEC. CAPACITORS BW SERIES**

**PACKING METHOD**

The leader length of the tape shall not be less than 400 mm including 10 or more embossed sections in which no parts are contained.

The winding core is provided with an over 160mm long empty section; punched carrier is only suitable for  $\phi D \leq 5$  mm.



**SEALING TAPE REEL STRENGTH**

**Peel angle:** 165 to 180°C refer to the surface on which the tape is glued.

**Peel speed:** 300mm per minutes ; **The peel strength** must be 0.1 ~ 0.7N under these conditions.:

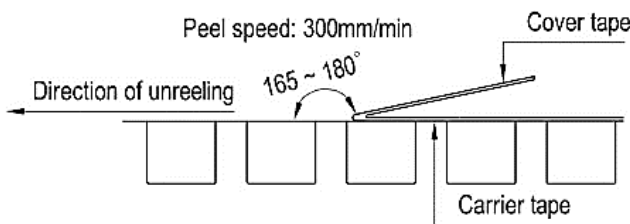

## CONDUCTIVE POLYMER HYBRID ALUMINUM ELEC. CAPACITORS BW SERIES

### GUIDELINES FOR GENERAL APPLICATION CIRCUIT DESIGN

- (1) Polarity** Most of the aluminum electrolytic capacitors are polarized. Therefore, they must be installed with the correct polarity. Usage in the reverse polarity results into a short-circuit condition that may damage or even explode the capacitor. In addition, it may influence circuit functionality. A bi-polar electrolytic capacitor should be installed when polarity across a capacitor is unstable / reversible. It should be, however, noted that usage of both polar and bi-polar capacitors are limited to DC applications. They must NOT be used for AC application.
- (2) Operating Voltage** Applied DC voltage must not exceed rated voltage of the capacitor. Applying higher voltage than its rated voltage across a capacitor terminals cause overheating due to higher leakage currents and capacitor dielectric/insulation deterioration that will ultimately affect a capacitor's performance. The device, however, is capable of working under short-time transient voltages such as DC transients and peak AC ripples. Reverse voltages higher than 1 Volt within a specified temperature limit or AC voltages are not permissible. Overall, using capacitors at recommended operating voltages can prolong its lifespan. Note that the result of DC voltage overlapped with peak ripple voltage should not exceed rated voltage.
- (3) Ripple Current** One of the key functions of any capacitor is removal of the ripple current i.e. the RMS value of AC flowing through a capacitor. But, a ripple current higher than rated ripple current will drop resultant capacitance, cause undue internal heating and thus reduces life span of the capacitor. In extreme cases, internal high temperature will cause the pressure relief vent to operate while destroying the device. Overall, it is important to note that an electrolytic capacitor must be used within a permissible range of ripple current. Indicators like temperature coefficient of allowable ripple current are generally used to determine life expectancy of the capacitor, but to avoid related complex calculations and for the sake of simplicity, we haven't provided temperature coefficient in the catalogue. But it offers key indicators like maximum operating temperature for calculation of life expectancy at a given temperature.
- (4) Operating Temperature** Capacitors should be used within a permissible range of operating temperatures. Using capacitor at a higher temperature than maximum rated temperature will considerably shorten its life. In the worst-case scenario, high temperature can cause pressure relief vent to operate and the device will get destroyed. Using capacitors at an ambient room temperature assure their longer life.
- (5) Leakage Current** Leakage current flows through a capacitor when DC voltage is applied across it. Leakage current varies with changes in ambient temperature and applied DC voltage level and its time of application. Over voltage situation, presence of moisture, and thermal stresses, especially occurring during the soldering process can enhance leakage current. Initial leakage current is usually higher and does not decrease until voltage is applied for a certain period of time. It is recommended to keep initial leakage current within specified levels.
- (6) Charge and Discharge** Regular electrolytic capacitors are not suitable for rapid charging/discharging circuits. Such usage may either cause reduction in overall capacitance or damage due to overheating. Aillen provides special assistance for selecting appropriate capacitors for rapid charging/discharging circuits.

**CONDUCTIVE POLYMER HYBRID ALUMINUM ELEC. CAPACITORS BW SERIES**

**(6) Charge and Discharge** Regular electrolytic capacitors are not suitable for rapid charging/discharging circuits. Such usage may either cause reduction in overall capacitance or damage due to overheating. Aillen provides special assistance for selecting appropriate capacitors for rapid charging/discharging circuits.

**(7) Surge Voltage** The Surge voltage rating is referred as the maximum DC over voltage that may be applied to an electrolytic capacitor for a short time interval of 30 seconds at infrequent time intervals not exceeding 5.5minutes with a limiting resistance of 1kΩ. Unless otherwise described on the catalogue or product specifications, please do not apply a voltage exceeding the capacitor’s voltage rating. The rated surge voltages corresponding to rated voltages of electrolytic capacitors are presented as follows:

Rated Voltage (V)	4	6.3	10	16	25	35	50	63	80	100
Surge Voltage (V)	4.6	7.3	11.5	18.4	28.8	40.3	57.5	72.5	92	115

Rated Voltage (V)	160	250	315	350	400	420	450	500	525	
Surge Voltage (V)	184	288	347	385	440	462	495	550	578	

**(8) Condition of Use** The capacitors shall NOT be exposed to: **(a)** Fluids including water, saltwater spray, oil, fumes, highly humid or condensed climates, etc. **(b)** Ambient conditions containing hazardous gases/fumes like hydrogen sulfide, sulfurous acid, nitrous acid, chlorine or bromine gas, ammonia, etc. **(c)** Exposed to ozone, ultraviolet rays and radiation. **(d)** Severe vibrations or physical shocks that exceeds the specifications mentioned in this catalogue.

**(9) Circuit Design Consideration** **(a)** Please ensure whether application, operating and mounting conditions satisfy the conditions specified in the catalog before installation of a capacitor. Please consult Aillen, if any of the conditions are beyond the conditions specified in the catalog. **(b)** Heat-generating components or heat sinks should not be placed closer to Aluminum electrolytic capacitors on the PCB to avoid their premature failure. A cooling system is recommended to improve their reliable working. **(c)** Electrical characteristics and performance of aluminum electrolytic capacitors are affected by variation of applied voltage, ripple current, ripple frequency and operating temperature. Therefore, these parameters shall not exceed specified values in the catalog. **(d)** Aluminum capacitors may be connected in the parallel fashion for increasing total capacitance and/or for achieving higher ripple current capability. But, such design may cause unequal current flow through each of the capacitors due to differences in their impedances. **(e)** When two or more capacitors are connected in series, voltage across each capacitor may differ and fall below the applied voltage. A resistor should be placed across each capacitor so as to match applied voltage with voltage across a capacitor. **(f)** Please consult Aillen while selecting a capacitor for high frequency switching circuit or a circuit that undergoes rapid charging/ discharging **(g)** Standard outer sleeve of the capacitor is not a perfect electrical insulator therefore is unsuitable for the applications that requires perfect electrical insulation. Please consult Aillen, if your application requires perfect electrical insulation. **(h)** Tilting or twisting capacitor body is not recommended once it is soldered to the PCB.

**CONDUCTIVE POLYMER HYBRID ALUMINUM ELEC. CAPACITORS BW SERIES**

**CAUTION FOR ASSEMBLING CAPACITORS**

**(1) Mounting (a)** Aluminum electrolytic capacitors are not recommended to reuse in other circuits once they are mounted and powered in a circuit. **(b)** Aluminum electrolytic capacitors may hold static charge between its anode and cathode, which is recommended to be discharged through a 1kΩ resistor before re-use. **(c)** A long storage of capacitors may result into its insulation deterioration. This can lead to a high leakage current when voltage is applied that may damage the capacitor. Capacitors following a long storage period must undergo voltage treatment/re-forming. Capacitors are charged by applying rated DC voltage through a resistor of 1kΩ in series at least for an hour. It is recommended to increase applied voltage gradually using a voltage regulator unit once capacitors are assembled on the board. The charging should be followed by discharging through a 1KΩ resistor. **(d)** Please check capacitor rated voltage before mounting. **(e)** Please check capacitor polarity before mounting. **(f)** Please don't drop capacitor on the floor / hard object. **(g)** Please don't deform the capacitor during installation. **(h)** Please confirm whether the lead spacing of the capacitors match with its pad spacing / footprint on PCB prior to installation. **(i)** Please avoid excessive mechanical shocks to capacitor during the auto-insertion process, inspection or centering operations. **(j)** Please don't place any wiring or circuit over the capacitor's pressure relief vent. The pressure relief vent may fail to open if adequate clearance space is not provided. Following table shows minimum clearance space required for different case diameters.

Case Diameter	Ø6.3~Ø16	Ø18~Ø35	Ø40 and Ø40 above
Clearance	2 mm	3 mm	5 mm5

**(2) Soldering (a)** Please confirm that soldering conditions, especially temperature and contact time are within our specifications. Dip or flow soldering temperature should be limited at  $260 \pm 5 \text{ }^\circ\text{C}$  for  $10 \pm 1 \text{ sec}$  while manual soldering using soldering iron should be limited at  $350 \pm 5^\circ\text{C}$  for  $3 +1/-0 \text{ seconds}$ . Please do not dip capacitor body into molten solder. A capacitor's life will be negatively affected if these conditions are violated. **(b)** Storage of capacitors in high humidity conditions is likely to affect the solder-ability of lead wires and terminals. **(c)** Reflow soldering should NOLY be used for SMD type capacitors. The temperature and duration shall not exceed the specified temperature and duration in the specification. If the temperature or duration is higher than the value specified, please consult Aillen before usage. **(d)** Standard aluminum electrolytic capacitors are not designed to withstand multiple reflow processes. Please consult Aillen if repeated reflowing is unavoidable. **(e)** Incorrect mounting on PCB with improper external strength applied on its lead wires or capacitor body after soldering may damage a capacitor's internal structure, cause short circuit, or lead to high leakage current issues. Do not bend or twist the capacitor body after soldering. Referring to the drawings below only case is recommended. **(i)** Correct soldering **(ii)** Hole-to-hole spacing on PCB differs from the lead space of lead wires. **(iii)** Lead wires are bent after soldering. **(iv)** Capacitor body doesn't stand vertical on PCB after soldering.

**CONDUCTIVE POLYMER HYBRID ALUMINUM ELEC. CAPACITORS BW SERIES**

**(3) Cleaning Circuit Boards after Soldering (a)** Following chemicals are not recommended for cleaning: Solvent containing halogen ions, Alkaline solvent, Xylene, Acetone, Terpene, petro-based solvent. **(b)** Recommended cleaning conditions: Fatty-alcohol - Pine Alpha ST-100S, Clean Through-750H and IPA (isopropyl alcohol) are examples of the most acceptable cleaning agents. Temperature of the cleaning agent must not exceed 60°C. Flux content in the cleaning agents should be limited to 2 Wt. %. Overall length of cleaning process (e.g., immersion, ultrasonic or other) shall be within 5 minutes (5 ~ 7mm height within 3 minutes). CFC substitute cleaning agents such as AK225AES can also be used for cleaning. In this case, its temperature shall not exceed 40 C and cleaning process (e.g., immersion, ultrasonic or other) shall be completed within 2 ~ 3 minutes. After cleaning capacitors should be dried with hot air for at least 10 minutes along with the PCB. Temperature of hot air shall not exceed maximum category temperature of the capacitor. Insufficient drying may cause appearance defects, sleeve shrinkage, and bottom-plate bulging. However, usage of this CFC substitute must completely regulated for protection of environment.

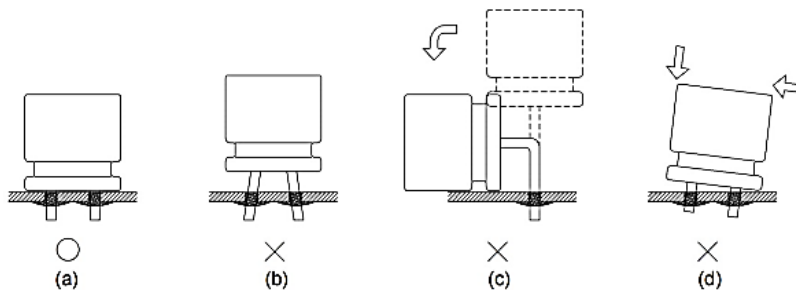

**MAINTENANCE INSPECTION**

Periodical inspection of aluminum capacitors is absolutely necessary, especially when they are used with industrial equipment. The following items should be checked: **(1)** Appearance: Bloated, vent operated, leaked, etc. **(2)** Electrical characteristic: Capacitance, tanδ, leakage current, and other specified items listed in specification. We recommend replacing the capacitors if any of the above mentioned items fail to meet specifications.

**STORAGE**

**(1)** The most suitable conditions for aluminum capacitor storage are 5 °C ~ 35°C and indoor relative humidity less than 75%. High temperature and/or humidity storage is detrimental to the capacitors. **(2)** Capacitors shall not be stored in wet or damp atmospheres containing water, brine, fumes or oil. **(3)** Capacitors storage area shall neither be exposed to hazardous gases such as hydrogen sulfide, sulfurous acid, nitrous acid, chlorine, ammonium, etc. nor to acidic or alkaline solutions. **(4)** Capacitors shall not be exposed to ozone, ultraviolet rays or radiation.

## CONDUCTIVE POLYMER HYBRID ALUMINUM ELEC. CAPACITORS BW SERIES

### ESTIMATION OF LIFE TIME

$$L_r = L_0 \times 2^{\frac{T_{0\max} - T_{r\max}}{10}}$$

**L<sub>r</sub>**: Estimated lifetime (hours) **L<sub>0</sub>**: Base lifetime specified at maximum operating temperature with applied the DC voltage and the ripple current (hours) **T<sub>0 max</sub>**: The core temperature that rated ripple current applied at maximum operating temperature. **T<sub>r max</sub>**: The core temperature that applied actual ripple current at ambient

### ESTIMATION OF LIFE TIME

Please consult with a local industrial waste disposal specialist when disposing of aluminum electrolytic capacitors

### ENVIRONMENTAL CONSIDERATION

Manufacturer already have received ISO 14000 certificate. Cadmium (Cd), Lead (Pb), Mercury (Hg), Hexavalent Chromium (Cr+6), PBB, PBDE, DEHP, BBP, DBP and DIBP have never been using in capacitor. If you need “Halogen-free” products, please consult with us.

### AEC-Q200 COMPLIANCE

Automotive Electronics Counsel (AEC) has established various electronic component qualification/reliability standards in order to serve automotive electronics industry. AEC-Q200 standard is dedicated for passive components like capacitors, inductors, etc. and is widely adopted domestically as well as internationally. Manufacturer offers compliant product designs and support services to satisfy customers’ product requirements, including the AEC-Q200 required criteria of the reliability tests. Manufacturer’s capacitors are professionally designed to outperform all requirements of AEC-Q200.

### NOTE

For further details, please refer to IEC 60384-4- Fixed capacitors for use in electronic equipment – Part 4: Sectional specification – Aluminum electrolytic capacitors with solid (MnO<sub>2</sub>) and non-solid electrolyte (Established in January 1995, Revised in March 2007), and EIAJ RCR-2367B- Guideline of notabilia for fixed aluminum electrolytic capacitors for use in electronic equipment [Technical Standardization Committee on Passive Components (Established in March 1995, Revised in March 2002)].

### DISCLAIMER

NextGen Component, Inc. reserves the right to make changes to the product(s) and or information contained herein without notice. No liability is assumed as a result of their use or application. No rights under any patent accompany the sale of any such product(s) or information