

User Manual

AGS-910

High Density 1U GPU Server, w/
up to 3 PCIe x16 FH/FL Double-
depth & 1 PCIe x8 FH/HL Single-
depth Expansion Card

ADVANTECH

Enabling an Intelligent Planet

Copyright

The documentation and the software included with this product are copyrighted 2014 by Advantech Co., Ltd. All rights are reserved. Advantech Co., Ltd. reserves the right to make improvements in the products described in this manual at any time without notice. No part of this manual may be reproduced, copied, translated or transmitted in any form or by any means without the prior written permission of Advantech Co., Ltd. Information provided in this manual is intended to be accurate and reliable. However, Advantech Co., Ltd. assumes no responsibility for its use, nor for any infringements of the rights of third parties, which may result from its use.

Acknowledgements

Intel and Pentium are trademarks of Intel Corporation.

Microsoft Windows and MS-DOS are registered trademarks of Microsoft Corp.

All other product names or trademarks are properties of their respective owners.

Product Warranty (2 years)

Advantech warrants to you, the original purchaser, that each of its products will be free from defects in materials and workmanship for two years from the date of purchase.

This warranty does not apply to any products which have been repaired or altered by persons other than repair personnel authorized by Advantech, or which have been subject to misuse, abuse, accident or improper installation. Advantech assumes no liability under the terms of this warranty as a consequence of such events.

Because of Advantech's high quality-control standards and rigorous testing, most of our customers never need to use our repair service. If an Advantech product is defective, it will be repaired or replaced at no charge during the warranty period. For out-of-warranty repairs, you will be billed according to the cost of replacement materials, service time and freight. Please consult your dealer for more details.

If you think you have a defective product, follow these steps:

1. Collect all the information about the problem encountered. (For example, CPU speed, Advantech products used, other hardware and software used, etc.) Note anything abnormal and list any onscreen messages you get when the problem occurs.
2. Call your dealer and describe the problem. Please have your manual, product, and any helpful information readily available.
3. If your product is diagnosed as defective, obtain an RMA (return merchandise authorization) number from your dealer. This allows us to process your return more quickly.
4. Carefully pack the defective product, a fully-completed Repair and Replacement Order Card and a photocopy proof of purchase date (such as your sales receipt) in a shippable container. A product returned without proof of the purchase date is not eligible for warranty service.
5. Write the RMA number visibly on the outside of the package and ship it prepaid to your dealer.

A Message to the Customer

Advantech Customer Services

Each and every Advantech product is built to the most exacting specifications to ensure reliable performance in the harsh and demanding conditions typical of industrial environments. Whether your new Advantech equipment is destined for the laboratory or the factory floor, you can be assured that your product will provide the reliability and ease of operation for which the name Advantech has come to be known.

Your satisfaction is our primary concern. Here is a guide to Advantech's customer services. To ensure you get the full benefit of our services, please follow the instructions below carefully.

Technical Support

We want you to get the maximum performance from your products. So if you run into technical difficulties, we are here to help. For the most frequently asked questions, you can easily find answers in your product documentation. These answers are normally a lot more detailed than the ones we can give over the phone.

So please consult this manual first. If you still cannot find the answer, gather all the information or questions that apply to your problem, and with the product close at hand, call your dealer. Our dealers are well trained and ready to give you the support you need to get the most from your Advantech products. In fact, most problems reported are minor and are easily solved over the phone.

In addition, free technical support is available from Advantech engineers every business day. We are always ready to give advice on application requirements or specific information on the installation and operation of any of our products.

Declaration of Conformity

FCC Class A

Note: This equipment has been tested and found to comply with the limits for a Class A digital device, pursuant to part 15 of the FCC Rules. These limits are designed to provide reasonable protection against harmful interference when the equipment is operated in a commercial environment. This equipment generates, uses, and can radiate radio frequency energy and, if not installed and used in accordance with the instruction manual, may cause harmful interference to radio communications. Operation of this equipment in a residential area is likely to cause harmful interference in which case the user will be required to correct the interference at his own expense.

Safety Information

Retain and follow all product safety and operating instructions provided with your equipment. In the event of a conflict between the instructions in this guide and the instructions in equipment documentation, follow the guidelines in the equipment documentation.

Observe all warnings on the product and in the operating instructions. To reduce the risk of bodily injury, electric shock, fire and damage to the equipment, observe all precautions included in this guide.

You must become familiar with the safety information in this guide before you install, operate, or service Advantech products.

Machine Room Environment

- Make sure that the area in which you install the system is properly ventilated and climate-controlled.
- Ensure that the voltage and frequency of your power source match the voltage and frequency inscribed on the electrical rating label of the equipment.
- Do not install the system in or near a plenum, air duct, radiator, or heat register.
- Never use the product in a wet location.

Equipment Chassis

- Do not block or cover the openings to the system.
- Never push objects of any kind through openings in the equipment.
- Dangerous voltages might be present.
- Conductive foreign objects can produce a short circuit and cause fire, electric shock, or damage to your equipment.
- Lift equipment using both hands and with your knees bent.

Rack Mount Instructions

The following or similar rack-mount instructions are included with the installation instructions:

- Elevated Operating Ambient - If installed in a closed or multi-unit rack assembly, the operating ambient temperature of the rack environment may be greater than room ambient. Therefore, consideration should be given to installing the equipment in an environment compatible with the maximum ambient temperature (T_{ma}) specified by the manufacturer.
- Reduced Air Flow - Installation of the equipment in a rack should be such that the amount of air flow required for safe operation of the equipment is not compromised.
- Mechanical Loading - Mounting of the equipment in the rack should be such that a hazardous condition is not achieved due to uneven mechanical loading.
- Circuit Overloading - Consideration should be given to the connection of the equipment to the supply circuit and the effect that overloading of the circuits might have on overcurrent protection and supply wiring.
- Appropriate consideration of equipment nameplate ratings should be used when addressing this concern.
- Reliable Earthing - Reliable earthing of rackmounted equipment should be maintained. Particular attention should be given to supply connections other than direct connections to the branch circuit (e.g. use of power strips)."

- Make sure only one component is extended at a time. A rack might become unstable if more than one component is extended.

Equipment Batteries*

- The system battery contains lithium manganese dioxide. If the battery pack is not handled properly, there is risk of fire and burns.
- Do not disassemble, crush, puncture, short external contacts, or dispose of the battery in fire or water.
- Do not expose the battery to temperatures higher than 60°C (140°F).
- The system battery is not replaceable. If the battery is replaced by an incorrect type, there is danger of explosion. Replace the battery only with a spare designated for your product.
- Do not attempt to recharge the battery.
- Dispose of used batteries according to the instructions of the manufacturer.
- Do not dispose of batteries with the general household waste. To forward them to recycling or proper disposal, use the public collection system or return them to Advantech, your authorized Advantech partner, or their agents.

Equipment Modifications

- Do not make mechanical modifications to the system. Advantech is not responsible for the regulatory compliance of Advantech equipment that has been modified.

Equipment Repairs and Servicing

- The installation of internal options and routine maintenance and service of this product should be performed by individuals who are knowledgeable about the procedures, precautions, and hazards associated with equipment containing hazardous energy levels.
- Do not exceed the level of repair specified in the procedures in the product documentation. Improper repairs can create a safety hazard.
- Allow the product to cool before removing covers and touching internal components.
- Remove all watches, rings, or loose jewelry when working before removing covers and touching internal components.
- Do not use conductive tools that could bridge live parts.
- Use gloves when you remove or replace system components; they can become hot to the touch.
 - If the product sustains damage requiring service, disconnect the product from the AC electrical outlet and refer servicing to an authorized service provider. Examples of damage requiring service include:
 - The power cord, extension cord, or plug has been damaged.
 - Liquid has been spilled on the product or an object has fallen into the product.
 - The product has been exposed to rain or water.
 - The product has been dropped or damaged.
 - The product does not operate normally when you follow the operating instructions.

Note! *Danger of explosion if battery is incorrectly replaced.*



Replace only with the same or equivalent type recommended by the manufacture. Discard used batteries according to the manufacture's instructions.

Danger d'explosion si la batterie est remplacée de façon incorrecte.

Remplacez-la uniquement avec le même type ou équivalent recommandé par la fabrication. Jetez les piles usagées selon les instructions du fabricant.

Peripheral Compatibility

Category	Advantech PN	Vendor	Part Description	Remarks
System	AGS-910-R11A1E	Advantech	Basic sku(two lan ports)	
	AGS-910I-R11A1E	Advantech	IPMI sku(quad lan ports)	
CPU	96MPXE-2.1-20M20T	Intel	Xeon E5-2658/2.1GHz/8cores	95W
	96MPXE-2.0-15M20T	Intel	Xeon E5-2620/2.0GHz/6cores	95W
	96MPXE-1.8-20M20T	Intel	Xeon E5-2648L/1.8GHz/8cores	70W
	96MPXE-2.5-10M20T	Intel	Xeon E5-2609 v2/2.5GHz/4cores	80W
	96MPXE-2.6-15M20T	Intel	Xeon E5-2630 v2/2.6GHz/6cores	80W
	96MPXE-1.9-25M20T	Intel	Xeon E5-2648L v2/1.9GHz/10cores	70W
	96MPXEI-2.0-20M20T	Intel	Xeon E5-2640 v2/2.0GHz/8cores	95W
	96MPXEI-2.8-25M20T	Intel	Xeon E5-2680 v2/2.8GHz/10cores	115W
	96MPXEI-2.0-15M20T	Intel	Xeon E5-2618L v2/2.0GHz/6cores	50W
	96MPXE-2.4-25M20T	Intel	Xeon E5-2658 v2/2.4GHz/10cores	95W
	TBD	Intel	Xeon E5-2680/2.7GHz/8cores	130W
	TBD	Intel	Xeon E5-2660/2.2GHz/8cores	95W
	TBD	Intel	Xeon E5-2650L/1.8GHz/8cores	70W
	TBD	Intel	Xeon E5-2630L/2.0GHz/6cores	60W
	TBD	Intel	Xeon E5-2643/3.3GHz/4cores	130W
	TBD	Intel	Xeon E5-2609/2.4GHz/4cores	80W
	TBD	Intel	Xeon E5-2667/2.9GHz/6cores	130W
	TBD	Intel	Xeon E5-2650/2.0GHz/8cores	95W
	TBD	Intel	Xeon E5-2640/2.5GHz/6cores	95W
	TBD	Intel	Xeon E5-2603/1.8GHz/4cores	80W
	TBD	Intel	Xeon E5-2630/2.3GHz/6cores	95W
	TBD	Intel	Xeon E5-2620/2.0GHz/6cores	95W
	TBD	Intel	Xeon E5-2670/2.6GHz/8cores	115W
	TBD	Intel	Xeon E5-2690/2.9GHz/8cores	135W
	TBD	Intel	Xeon E5-2665/2.4GHz/8cores	115W
	TBD	Intel	Xeon E5-2637/3.0GHz/2cores	80W
	TBD	Intel	Xeon E5-2643 v2/3.5GHz/6cores	130W
	TBD	Intel	Xeon E5-2650 v2/2.6GHz/8cores	95W
	TBD	Intel	Xeon E5-2650L v2/1.7GHz/10cores	70W
	TBD	Intel	Xeon E5-2660 v2/2.2GHz/10cores	95W
	TBD	Intel	Xeon E5-2667 v2/3.3GHz/8cores	130W
	TBD	Intel	Xeon E5-2670 v2/2.5GHz/10cores	115W
TBD	Intel	Xeon E5-2690 v2/3.0GHz/10cores	130W	

CPU	TBD	Intel	Xeon E5-2695 v2/2.4GHz/12cores	115W
	TBD	Intel	Xeon E5-2697 v2/2.7GHz/12cores	130W
	TBD	Intel	Xeon E5-2620 v2/2.1GHz/6cores	80W
	TBD	Intel	Xeon E5-2630L v2/2.4GHz/6cores	60W
	TBD	Intel	Xeon E5-2637 v2/3.5GHz/4cores	130W
	TBD	Intel	Xeon E5-2603 v2/1.8GHz/4cores	80W
	TBD	Intel	Xeon E5-2628L v2/1.9GHz/8cores	70W
Memory	TBD	TBD	DDR3 240PIN Non-ECC/ECC/ REG, capacity up to 16GB per mod- ule.	-
*SATA HDD	96ND1T-ST-SG7KE	Seagate	2.5" SATA3 1T Enterprise	ST91000 640NS
	96ND250G-ST-SG7K	Seagate	2.5" SATA2 250G Enterprise	ST92506 10NS
SAS HDD	96ND500G-SS-SG7KE	Seagate	2.5" SAS2 500G	ST95006 20SS
CPU heat- sink	1960065593N001	Dynatron	LGA2011 1U heatsink with Cu fin & CU VC.	T318 For CPU0 socket
	1960065591N001	Dynatron	LGA2011 1U heatsink with Cu fin & CU VC.	T236 For CPU1 socket
Riser Card	9696910R20E	Advantech	AGS-910 UM x8 riser	-
	9696910R00E	Advantech	AGS-910 UL x16 riser	-
	9696910R10E	Advantech	AGS-910 LL x16 riser	-
	9696910R30E	Advantech	AGS-910 LR x16 riser	-
Power supply	96PSR-1K1W1U-AD	3Y	1100W power module	YM- 2112A
SATA DOM	TBD	Innodisk	16G MLC SATA DOM	DESSB- 16GD07S W1SC
	TBD	Innodisk	32G MLC SATA DOM	DESSB- 32GD07S W1SC
	SQF-SDMM2-64G-S7CB	Advantech	64G MLC SATA DOM	SATA2 interface
	SQF-SDMS2-32G-S7CB	Advantech	32G SLC SATA DOM	SATA2 interface
RAID Card	96RC-SAS-4P-PE-LS	LSI	9240-4i SAS/SATA RAID card	-
	96RC-SAS-4P-PE-LS2	LSI	9260-4i SAS/SATA RAID card	-
RAID Card cable	96CB-SAS-SATA-4P1	-	CABLE MINI SAS TO 4-PORT SATA 1M	Without SGPIO function

Note! AGS-910 system **MUST** use the SSD or enterprise level SATA HDD or SAS HDD.



Initial Inspection

Before power up the system, please make sure that the following materials have been shipped:

- 1 x AGS-910 system
- 1 x AGS-910 Startup Manual
- 1 x Driver CD (User Manual is included)
- 2 x CPU heatsink
- 1 x Slide rail kit
- 2 x Mounting ears with handle
- 1 x Warranty card
- 6 x power cable for expansion cards (pre-assembled in the system)
- 1 x CPU air duct (pre-assembled in the system)

If any of these items are missing or damaged, contact distributor or sales representative immediately. We have carefully inspected the AGS-910 mechanically and electrically before shipment. It should be free of marks and scratches and in perfect working order upon receipt. When unpacking the AGS-910, check it for signs of shipping damage. (For example, damaged box, scratches, dents, etc.) If it is damaged or it fails to meet the specifications, notify our service department or local sales representative immediately. Also notify the carrier. Retain the shipping carton and packing material for inspection by the carrier. After inspection, we will make arrangements to repair or replace the unit.

Order Information

Part number	Expansion slot	Lan port	IPMI
AGS-910-R11A1E	3*PCIe x16 + 1*PCIe x8	2	N/A
AGS-910I-R11A1E	3*PCIe x16 + 1*PCIe x8	4	Yes

Contents

Chapter 1	Overview	1
1.1	Introduction	2
1.2	Features	2
1.3	System Specifications	3
1.4	System Layout, LED, Jumpers and Connectors	5
1.4.1	LED Definitions	6
1.4.2	Jumpers	7
1.4.3	Connectors	8
1.5	Block Diagram	9
1.6	System Memory	9
1.7	Memory Installation Procedures	10
Chapter 2	Setting up	11
2.1	Before you Begin	12
2.1.1	Work Area	12
2.1.2	Tools	12
2.1.3	Precautions	12
2.2	Installing Motherboard Components	13
2.2.1	Removing the Chassis Cover	13
2.2.2	Installing the CPU and Heatsink	14
2.2.3	Installing the Memory	18
2.2.4	Installing Hard Drives	19
2.2.5	Installing PCIe x16 Expansion Cards	21
2.2.6	Installing PCIe x8 Expansion Card	25
2.3	Rack Mounting	29
2.3.1	Installing the Server in a Rack	29
Chapter 3	AMI BIOS	33
3.1	Introduction	34
3.2	BIOS Setup	35
3.2.1	Main Menu	35
3.2.2	Advanced BIOS Features Setup	36
3.2.3	Chipset	54
3.2.4	Server Management	63
3.2.5	Boot	67
3.2.6	Security	68
3.2.7	Save & Exit	69
Chapter 4	Chipset Software Installation Utility	71
4.1	Before You Begin	72
4.2	Introduction	72
4.2.1	Main Menu	72
4.3	Windows OS Driver Setup	73
Chapter 5	VGA Setup	75
5.1	Introduction	76
5.2	Windows Series Driver Setup	76

Chapter 6 LAN Configuration & SATA RAID & AHCI Setup **77**

6.1	LAN Configuration.....	78
6.1.1	Introduction	78
6.1.2	Features.....	78
6.1.3	Installation.....	78
6.1.4	Windows Series Driver Setup (LAN).....	79
6.2	AHCI & SATA RAID	80

Appendix A Programming the Watchdog Timer **. 81**

A.1	Watchdog Timer Overview.....	82
A.2	Programming the Watchdog Timer	82

Chapter 1

Overview

1.1 Introduction

The AGS-910 is a high performance Intel Xeon E5-2600 / 2600 v2 series system for server-grade IPC applications that require high computing power & multi-expansion slots in 1U system. This system supports Intel Xeon E5-2600 / 2600 v2 series processor and DDR3 1066/1333/1600/1866 MHz memory up to 128 GB.

AGS-910 provides 3 x PCIe x16 slot (x16 link)* + 1 x PCIe x8 slot (x8 link)*.

In addition, the AGS-910 has four Gigabit Ethernet LAN ports via four dedicated PCIe x1 gen2 bus, which offer bandwidth up to 500 MB/s, eliminating network bottlenecks. The fourth RJ-45 LAN connector which is also support IPMI* function, it allows remote control.

High reliability and outstanding performance makes AGS-910 the ideal platform for industrial server applications.

By using the Intel C602J chipset, the AGS-910 offers a variety of features such as 4 onboard SATA II, and 2 onboard SATA III interfaces; it supports IRST (Intel Rapid Storage Technology) and provides RAID 0, 1, 10 and 5 (Windows only*); and it has 6 USB 2.0 (2 in front side, 2 in rear side, 2 are internal Type-A connectors).

These powerful I/O capabilities ensure even more reliable data storage capabilities and high-speed I/O peripheral connectivity.

1.2 Features

General

- Intel E5-2600 /2600 v2 processor support: AGS-910 supports two Intel E5-2600 / 2600 v2 series Six/Eight/Ten/Twelve core processors.
- High performance I/O capability: Four Gigabit LAN, 3* PCIe x16 slot(x16 link) + 1* PCIe x8 slot(x8 link), 6 SATA connectors and 6 USB 2.0 ports.
- Proprietary form factor with industrial features: AGS-910 provides industrial features like long product lifecycle, reliable operation, watchdog timer, etc.
- IPMI 2.0 support: AGS-910I equipped with ASPEED 2300 BMC chip supports IPMI 2.0 (Intelligent Platform Management Interface 2.0) via fourth sharing LAN port.
- KVM over IP: AGS-910I KVM over IP function allows remote control of system through your own computer.

Note!



1. Each PCIe x16 slot could install a full-height / full-length / double-depth expansion card.
2. Each PCIe x8 slot could install a full-height / half-length / single depth expansion card.
3. IPMI module will be only included in AGS-910I sku.
4. Please refer to the release note of each Linux OS for Intel's C602J chipset SATA RAID function support.

1.3 System Specifications

Processor	
CPU	<ul style="list-style-type: none"> ■ Dual Intel LGA2011 Xeon processor sockets ■ Supports Intel Xeon E5-2600 / 2600 v2 series processor ■ Supports the processor TDP up to 135 W.
System Memory	
Memory Capacity	<ul style="list-style-type: none"> ■ Intel Xeon processor supports DDR3 memory bus ■ Total 8 240-pin memory slots provided ■ Supports total capacity up to 128 GB ■ 4 channels per processor, 1 memory slot per channel
Memory Type	<ul style="list-style-type: none"> ■ Supports DDR3 1066/1333/1600 MHz ECC Registered / ECC Unbuffered / Non-ECC Unbuffered Modules.
Memory Sizes	Each memory slot supports 1GB, 2GB, 4GB, 8GB and 16GB memory modules
Memory Voltage	<ul style="list-style-type: none"> ■ 1.35 V ■ 1.5 V
Error Detection	<ul style="list-style-type: none"> ■ Corrects single-bit errors ■ Detects double-bit errors (using ECC memory)
On-board Devices	
Chipsets	Intel C602J PCH provide 8xPCIe Gen2 lanes
Network Controllers	<ul style="list-style-type: none"> ■ 3 x Intel I210 Gigabit Ethernet Controller connected to C602J through PCIe Gen2 Lane. ■ 1x Intel 82579LM Gigabit PHY connected to C602J MAC. ■ Above network Supports 10BASE-T, 100BASE-TX, and 1000BASE-T, with RJ-45 output
VGA	ASPEED AST2300 controller with 64 MB VGA memory provides basic 2D VGA function.
Super I/O	Nuvoton NCT6776F chip provide motherboard, RS-232, parallel port and hardware monitor functions.
BMC	Sharing with the fourth RJ45 port.
Input / Output	
Storage	<ul style="list-style-type: none"> ■ Total 4 x 2.5" HDD bays, 2 ports provide 6 Gb/s bandwidth, 2 ports provide 3 Gb/s bandwidth. ■ RAID 0, 1, 5, 10 support (Windows only).
LAN	4 x RJ-45 LAN ports (10/100/1000 Base-T LAN).
USB	<ul style="list-style-type: none"> ■ 2 x USB 2.0 ports at rear window. ■ 2 x USB 2.0 ports at front window. ■ 2 x internal Type-A USB 2.0 port.
VGA	1 x D-Sub port
Serial Port / Header	2 x internal header (2 x 5 pin, 2.5 mm pitch) for UART port.
Power Supply	
Power	80 PLUS Platinum 1+1 redundant power supply 900 W @ 100 ~ 120 V 1100 W @ 200 ~ 240 V
Power Connector	
Expansion Card power	6 x 6 pin 12V power connector for 6 pin / 8 pin expansion card.
Expansion Slots	

PCI-express	<ul style="list-style-type: none"> ■ 3 x PCI-E x16 slot (Gen3 x16 link) <ul style="list-style-type: none"> – PCIEX16_SLOT2 (from CPU 0) – PCIEX16_SLOT3 (from CPU 0) – PCIEX16_SLOT6 (from CPU 1) ■ 1 x PCI-E x8 slot (Gen3 x8 link) <ul style="list-style-type: none"> – PCIEX8_SLOT1 (from CPU0)
System BIOS	
BIOS type	64 Mb SPI Flash EEPROM with AMI BIOS
PC Health Monitoring	
Voltage	Monitors for CPU Cores, +3.3 V, +5 V, +12 V, +5 V Standby, VBAT
Fan	<ul style="list-style-type: none"> ■ Three 4-pin 40x56 fan for CPU cooling. ■ Four 4-pin 40x56 fan & two 4-pin 40x28 fan for expansion card cooling. ■ All fans with tachometer status monitoring ■ Fan speed control for all fan connectors
Temperature	Monitoring for CPU0 & CPU1 (PECI) Monitoring for System (HWM)
Other Features (Case Open)	<ul style="list-style-type: none"> ■ Chassis intrusion detection ■ Chassis Intrusion header
Operating Environment / Compliance	
RoHS	RoHS Compliant 6/6 Pb Free
Environmental Spec.	<ul style="list-style-type: none"> ■ Operating Temperature: 0 to 40° C ■ Non-operating Temperature: -10 to 70° C ■ Operating Relative Humidity: 0% to 90% (non-condensing) ■ Non-operating Relative Humidity: 5% to 95% (non-condensing)

1.4 System Layout, LED, Jumpers and Connectors

Connectors on the AGS-910 are linked to external devices such as hard disk drives. In addition, AGS-910 has a jumper that are used to clean CMOS for BIOS.

The tables below list the functions of each jumper and connector. Later sections in this chapter give instructions for setting jumpers. Chapter 2 gives instructions for connecting external devices to AGS-910.

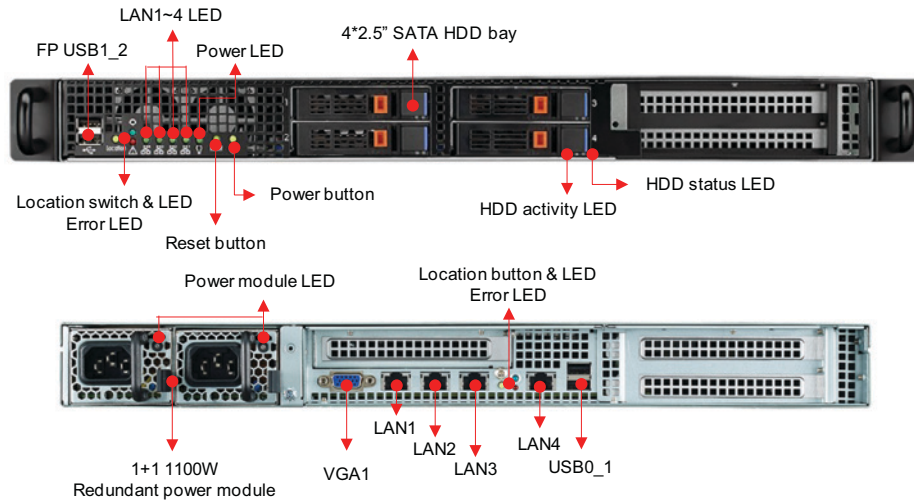
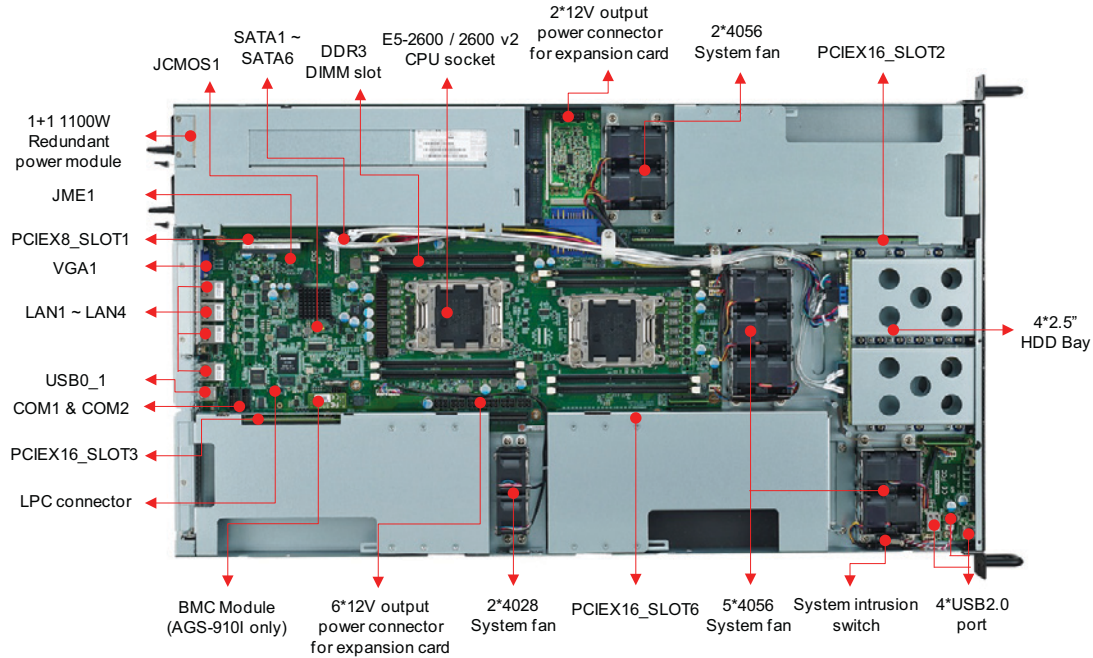

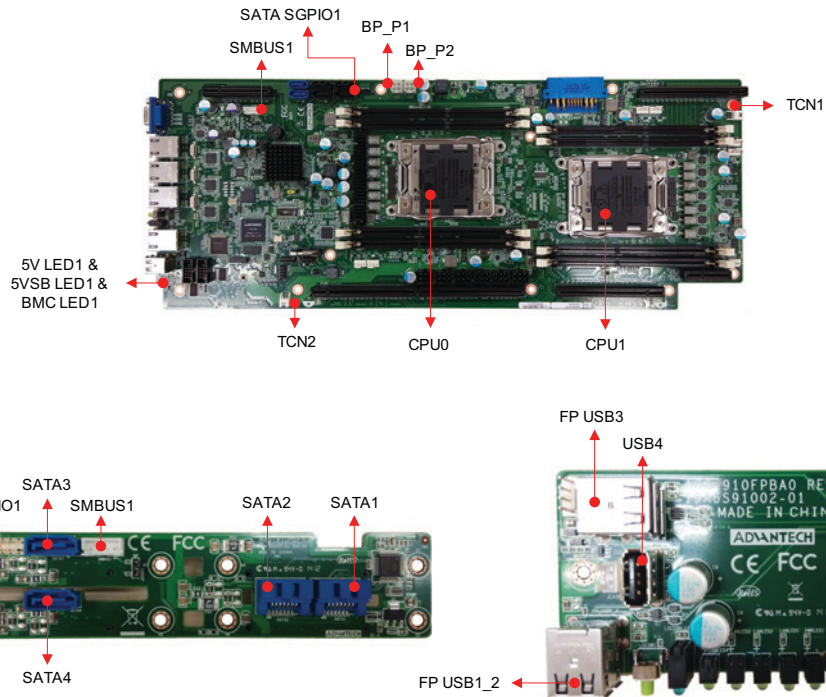

1.4.1 LED Definitions

Front I/O LED

LED	State	Color	Description
Power LED	On	Green	System is turned on
	Blinking	Green	System is under S1 or S4 state
	Off	Off	Power off
LAN1 ~ LAN4 LED	Blinking	Green	LAN active
	On	Green	LAN linked
	Off	Off	LAN unlinked
Error LED	On	Red	Fan fail; Over-voltage
	Off	Off	No failure
Location LED	On	Blue	System identified
	Off	Off	System unidentified

HDD LED

HDD status	Status LED Color: Amber	Activity LED Color: Green
No driver present or power disconnected	Off	-
Driver present	No activity	On
	Access activity	Blinking
HDD fail	On (only work under the RAID mode)	
Identify (locate the HDD)	4 Hz Blinking (only work under the RAID mode)	
SATA/SAS RAID building	1 Hz Blinking (only work under the RAID mode)	

On-Board LED

LED	State	Color	Description
5V LED1	On	Green	System power on
	Off	Off	Power off
5VSB LED1	On	Green	System power on, in sleep mode or in soft-off mode
	Off	Off	No AC power input
BMC LED1 (AGS-910I sku only)	Blinking	Green	BMC Controller is working normally

Rear I/O LED (1)

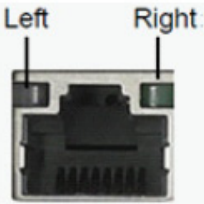
LED	Left LED	Right LED	Description	
	Off	Green	10 Mbps linked	
	Off	Blinking Green	10 Mbps Active	
	Amber	Green	100 Mbps linked	
	Amber	Blinking Green	100 Mbps Active	
	Green	Green	1000 Mbps linked	
	Green	Blinking Green	1000 Mbps Active	
	LAN1 ~ LAN4 LED	Off	Off	No Link

Rear I/O LED(2)

Error LED	On	Red	Fan fail ; Over temperature/voltage/current
	Off	Off	No failure
Location LED	On	Blue	System identified
	Off	Off	System unidentified
Power module LED	Blinking	Red	No AC power to this module
	Blinking	Blue	AC present standby output on
	On	Red	Power supply failure
	On	Blue	Power supply DC output ON and OK
	Off	Off	No AC power to power module

1.4.2 Jumpers

Label	Function	Default
JCMOS1	CMOS clear	1-2
JME1	ME update	1-2

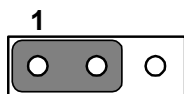

Keep CMOS data / Disable ME update

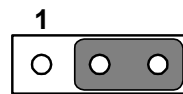

Clear CMOS data / Enable ME update

1.4.3 Connectors

CPU0	Intel LGA2011 CPU0 socket
CPU1	Intel LGA2011 CPU1 socket
SYS FAN1 ~ SYS FAN9	System fan connector (4-pin)
DIMMA0	Channel A DIMM0 of CPU0
DIMMB0	Channel B DIMM0 of CPU0
DIMMC0	Channel C DIMM0 of CPU0
DIMMD0	Channel D DIMM0 of CPU0
DIMME0	Channel E DIMM0 of CPU1
DIMMF0	Channel F DIMM0 of CPU1
DIMMG0	Channel G DIMM0 of CPU1
DIMMH0	Channel H DIMM0 of CPU1
TCN1 ~ TCN2	Expansion card thermal sensor cable connector (2-pin)
GPU 6P P1 ~ GPU 6P P8	12V power output connector for expansion card (6-pin)
BMC1 ~ BMC2	IPMI module connector
SATA1	Serial ATA1 hard drive connector (SATAIII)
SATA2	Serial ATA2 hard drive connector (SATAIII)
SATA3	Serial ATA3 hard drive connector (SATAII)
SATA4	Serial ATA4 hard drive connector (SATAII)
SATA5	Serial ATA5 hard drive connector (SATAII)
SATA6	Serial ATA6 hard drive connector (SATAII)
FP SLOT1	The slot for front panel board.
PCIEX8 SLOT1	PCIe x8 slot (gen3 x8 link) from CPU0
PCIEX16 SLOT2	PCIe x16 slot (gen3 x16 link) from CPU0
PCIEX16 SLOT3	PCIe x16 slot (gen3 x16 link) from CPU0
PCIEX16 SLOT5	PCIe x16 slot (gen3 x16 link) from CPU1 (Only for AGS-920/920I system)
PCIEX16 SLOT6	PCIe x16 slot (gen3 x16 link) from CPU1
LPC1	LPC port for debug & TPM module
COM1 ~ COM2	Serial port : RS-232
SATA SGPIO 1	Supports Serial_Link interface for onboard SATA connections
SMBUS1	For HDD status monitoring
BP P1 ~ P2	5V power output connector for HDD back plane
FP USB 1_2	USB port 3, 4
FP USB 3	USB port 5 (internal type-A, horizontal)
FP USB 4	USB port 6 (internal type-A, vertical)

1.5 Block Diagram

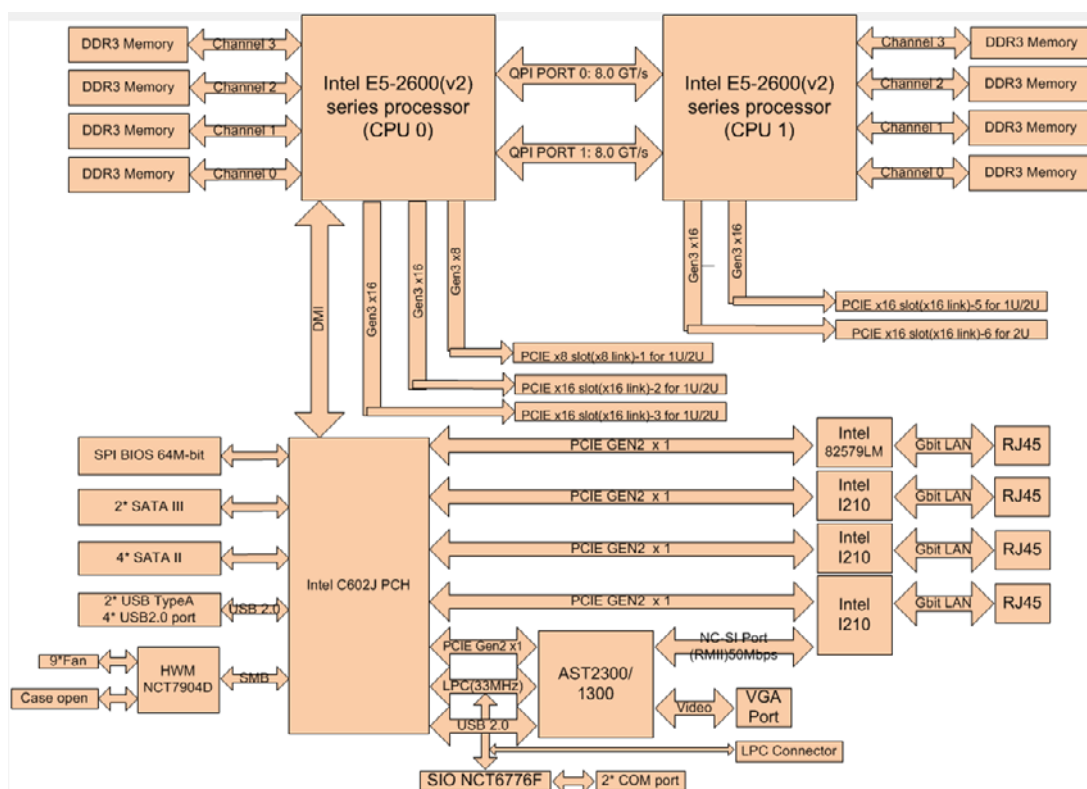

1.6 System Memory

AGS-910 has eight 240-pin memory slots for DDR3 1066/1333/1600 MHz memory modules with maximum capacity of 128 GB (Maximum 16 GB for each DIMM).

AGS-910 supports registered DIMMs or unbuffered DIMM with ECC / Non-ECC memory module.

1.7 Memory Installation Procedures

	Single processor installed (CPU0)				Dual processor installed (CPU0 & CPU1)								Quantity of memory module installed
	1	2	3	4	2	3	4	5	6	7	8		
DIMM A0	V	V	V	V	V	V	V	V	V	V	V	V	
DIMM B0		V	V	V		V	V	V	V	V	V	V	
DIMM C0			V	V				V	V	V	V	V	
DIMM D0				V						V	V	V	
DIMM E0					V	V	V	V	V	V	V	V	
DIMM F0							V	V	V	V	V	V	
DIMM G0									V	V	V	V	
DIMM H0												V	

Chapter 2

Setting up

2.1 Before you Begin

This chapter explains how to install the CPUs, CPU heatsinks, memory modules, and hard drives. Instructions on inserting add on cards are also given.

2.1.1 Work Area

Make sure you have a stable, clean working environment. Dust and dirt can get into components and cause malfunctions. Use containers to keep small components separated. Putting all small components in separate containers prevents them from becoming lost. Adequate lighting and proper tools can prevent you from accidentally damaging the internal components.

2.1.2 Tools

The following procedures require only a few tools, including the following:

- A cross head (Phillips) screwdriver
- A grounding strap or an anti-static pad

Most of the electrical and mechanical connections can be disconnected with your hands. It is recommended that you do not use pliers to remove connectors as it may damage the soft metal or plastic parts of the connectors.

2.1.3 Precautions

Components and electronic circuit boards can be damaged by discharges of static electricity. Working on a system that is connected to a power supply can be extremely dangerous. Follow the guidelines below to avoid damage to AGS-910 or injury to yourself.

- Ground yourself properly before removing the top cover of the system. Unplug the power from the power supply and then touch a safely grounded object to release static charge (i.e. power supply case). If available, wear a grounded wrist strap. Alternatively, discharge any static electricity by touching the bare metal chassis of the unit case, or the bare metal body of any other grounded appliance.
- Avoid touching motherboard components, IC chips, connectors, memory modules, and leads.
- The motherboard is pre-installed in the system. When removing the motherboard, always place it on a grounded anti-static surface until you are ready to reinstall it.
- Hold electronic circuit boards by the edges only. Do not touch the components on the board unless it is necessary to do so. Do not flex or stress circuit boards.
- Leave all components inside the static-proof packaging that they ship with until they are ready for installation.
- After replacing optional devices, make sure all screws, springs, or other small parts are in place and are not left loose inside the case. Metallic parts or metal flakes can cause electrical shorts.

2.2 Installing Motherboard Components

This section describes how to install components on to the mainboard, including CPUs, memory modules and add on cards.

2.2.1 Removing the Chassis Cover

Follow these instructions to remove AGS-910 chassis cover.

1. Unscrew the top cover as follows.

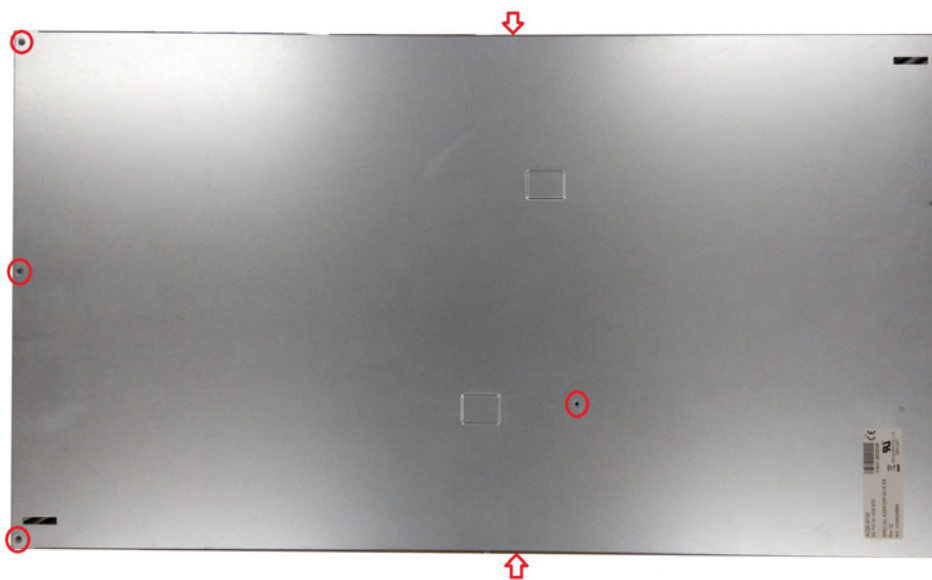

2. Slide the rear top cover out.

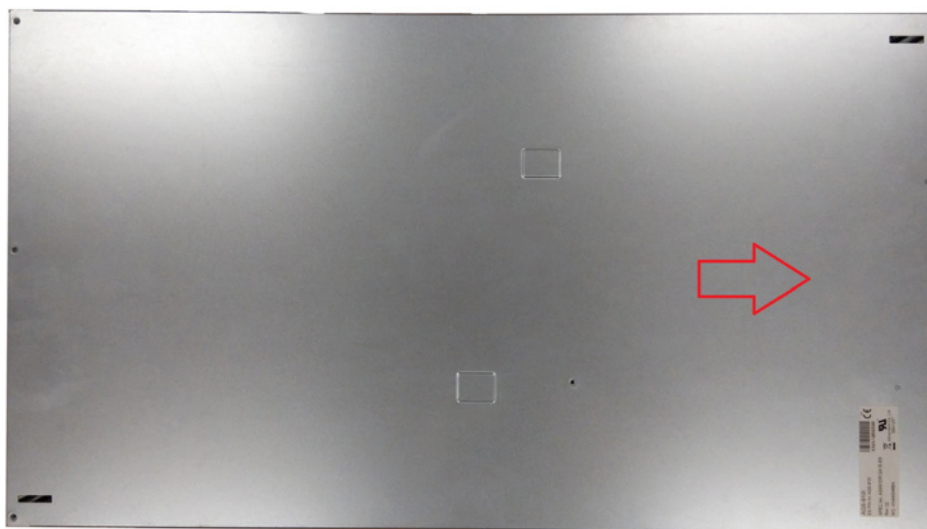

2.2.2 Installing the CPU and Heatsink

Follow the steps below to install CPUs and CPU heatsinks.

1. Locate the CPU sockets - you must install into the CPU0 socket first.

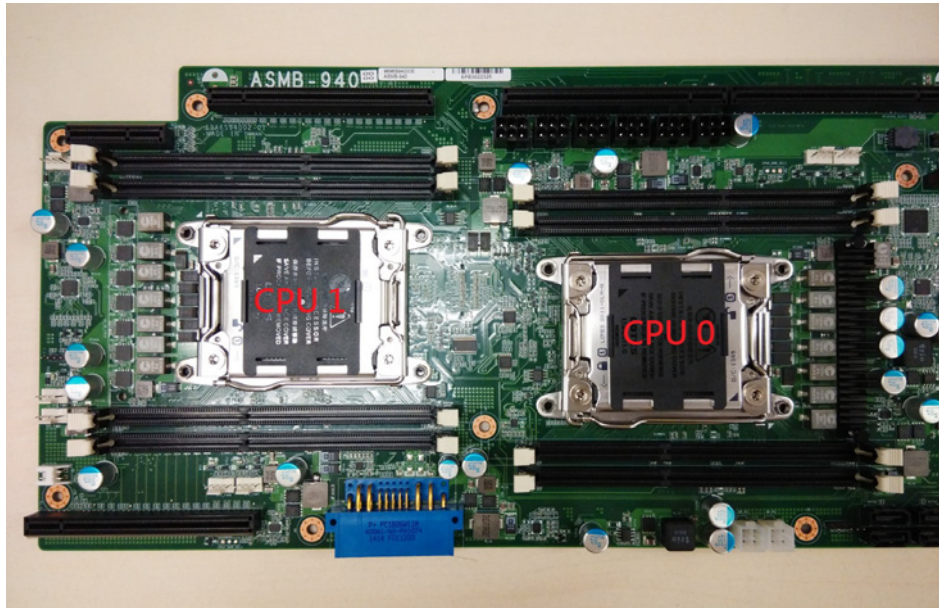

2. Pull the lever slightly away from the socket and then push it to a fully open position.

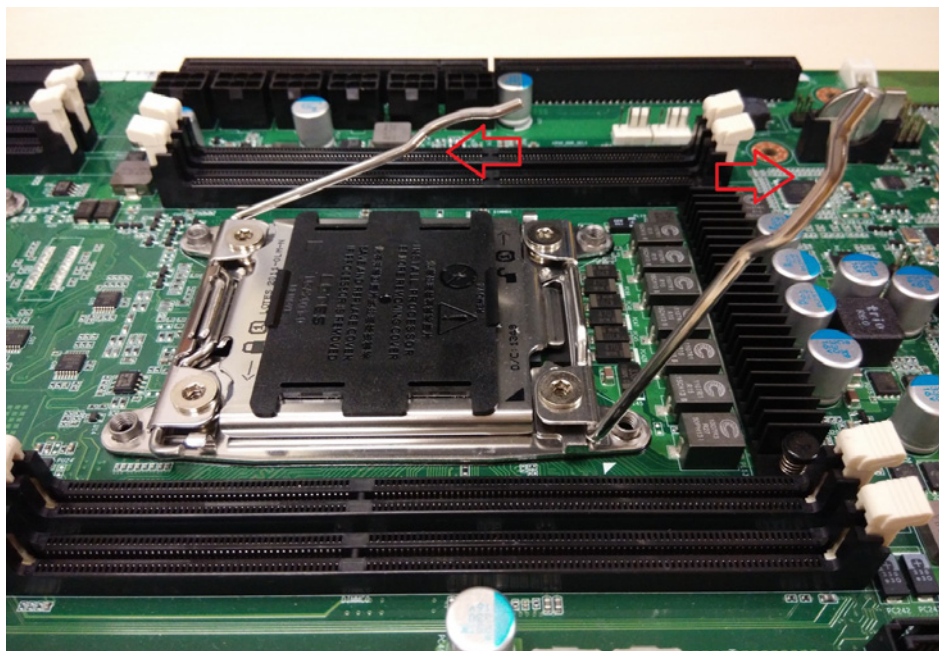

3. Push the CPU socket cover to a fully open position.

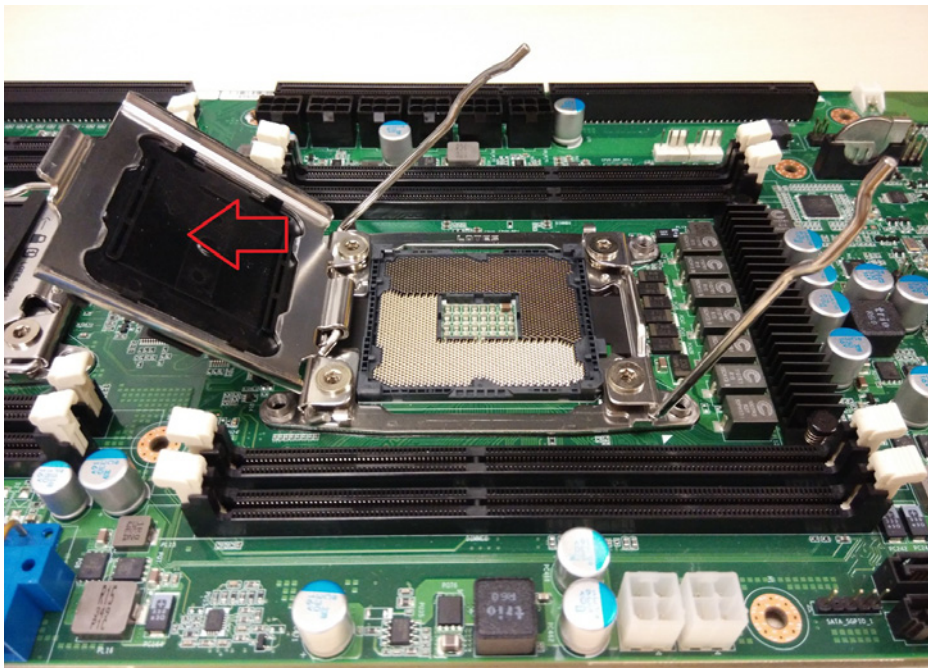

4. Place the CPU into the socket and make sure that the gold arrow is located in the right direction.

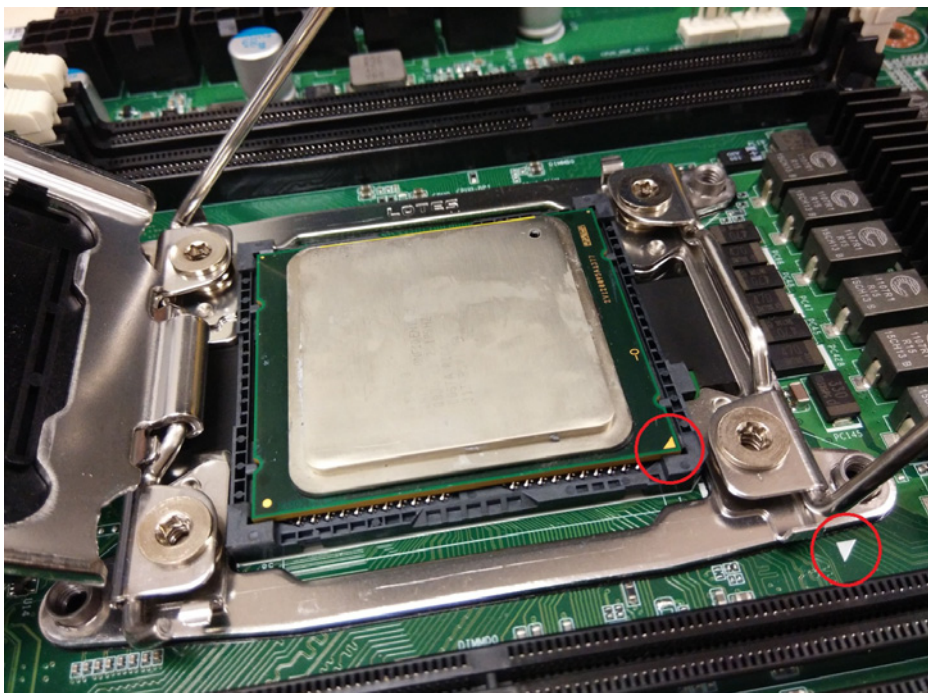

5. Take off the protection cap.

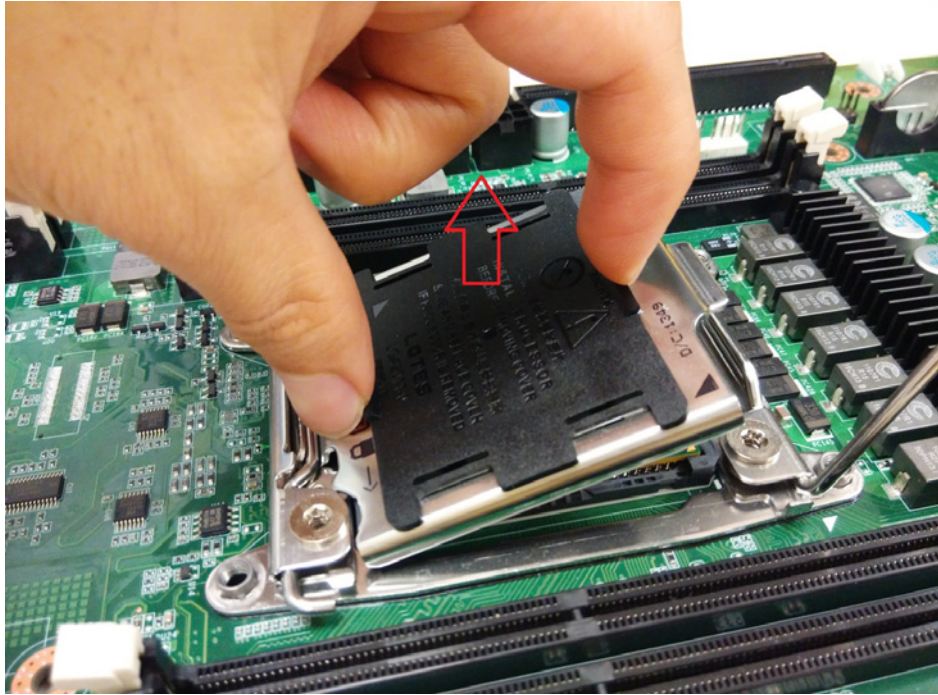

6. Close the CPU socket cover and press the lever down to secure the CPU.

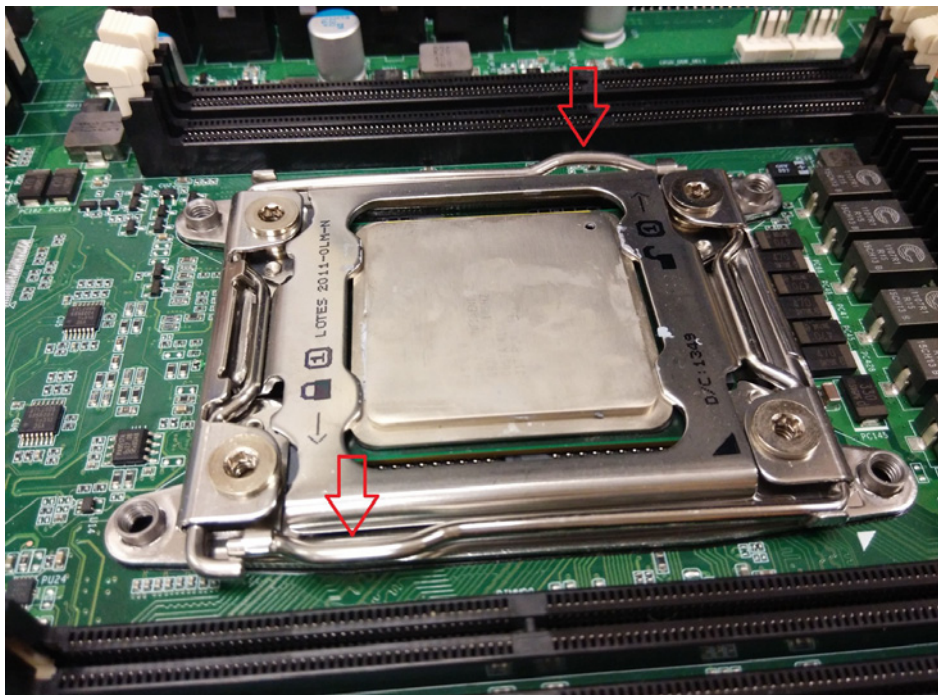

7. Position the heatsink on top of the CPU and secure it with 4 screws.

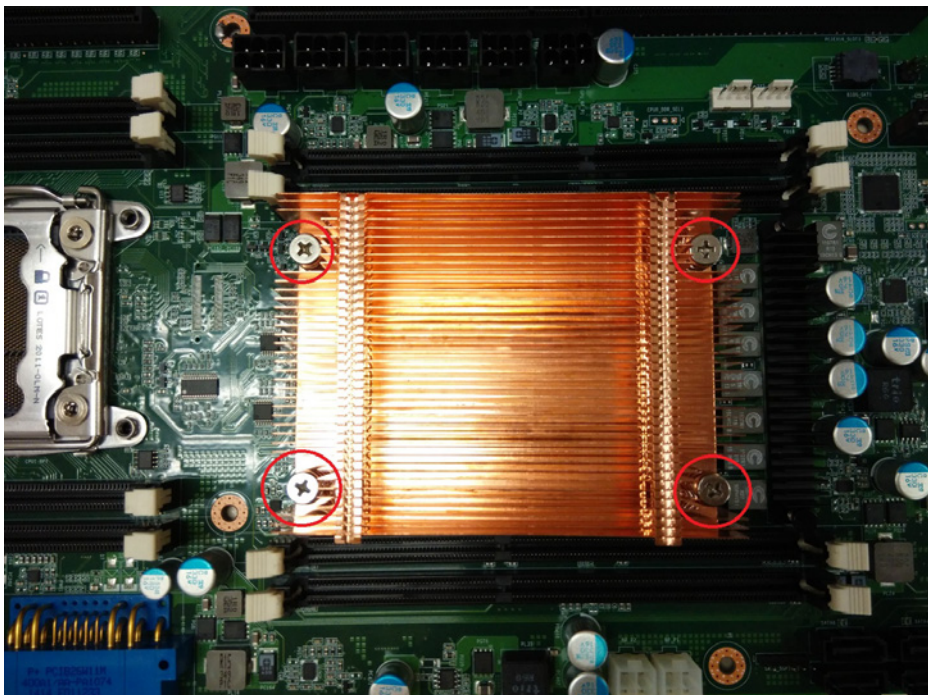

8. Repeat the procedures earlier to install the second processor and heatsink. Now follow the below image for CPU heatsink installation.

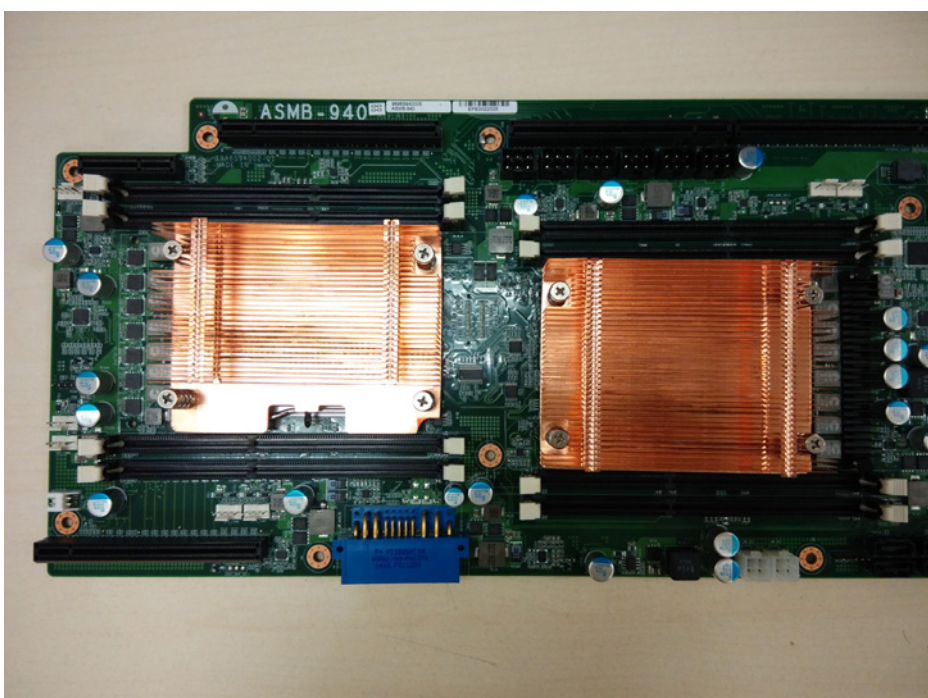

2.2.3 Installing the Memory

Follow these instructions to install the memory modules onto the motherboard.

1. Locate the memory slots on the motherboard.
2. Press the memory slot locking levers in the direction of the arrows as shown in the following illustration.

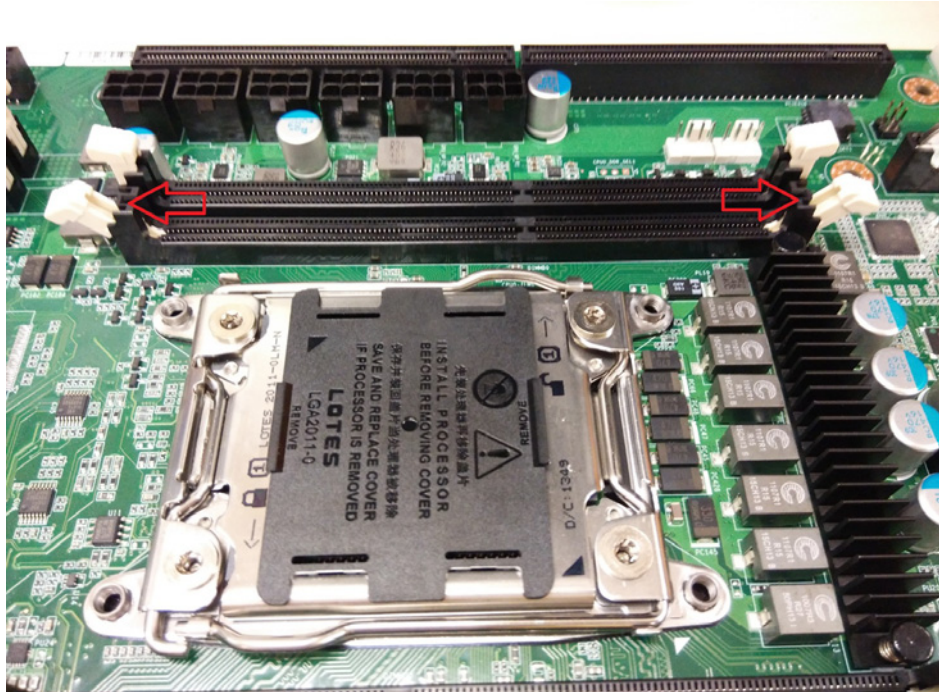

3. Align the memory module with the slot. When inserted properly, the memory slot locking levers lock automatically onto the indentations at the ends of the module. Follow the recommended memory population table to install the other memory modules.

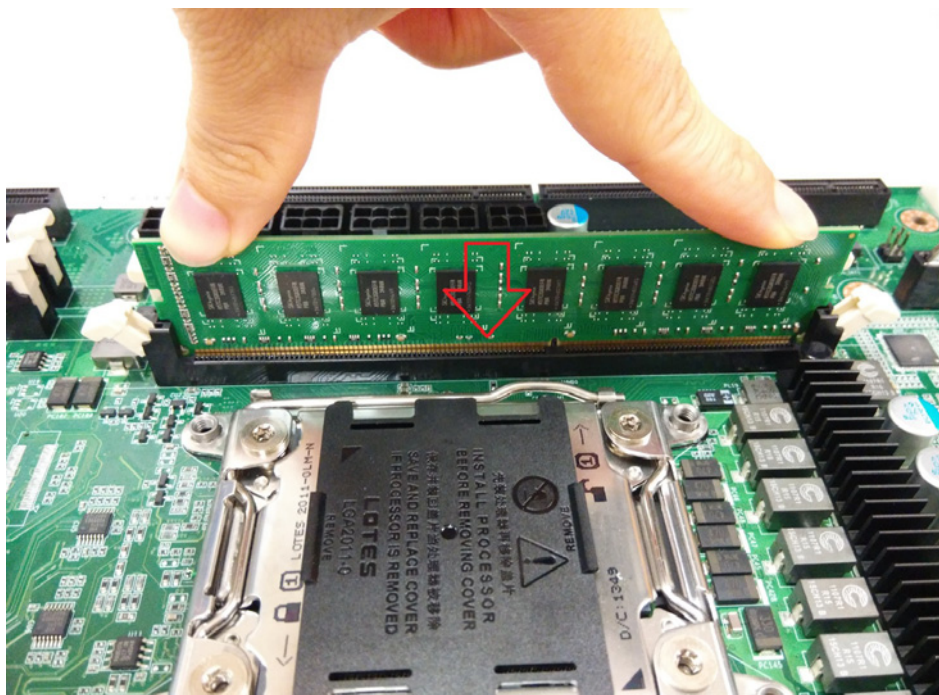

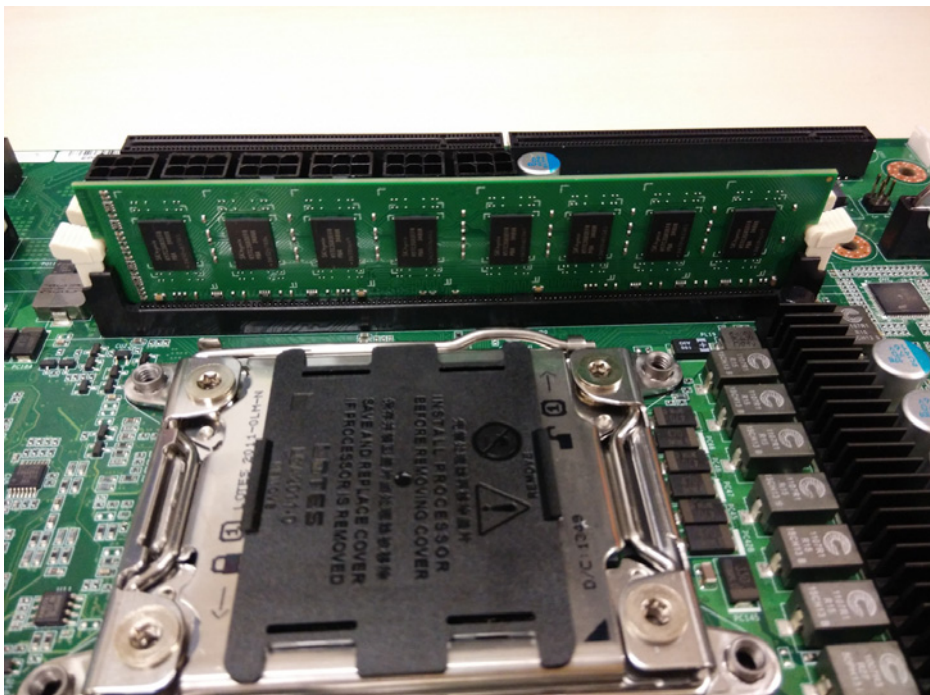

2.2.4 Installing Hard Drives

The AGS-910 supports four 2.5" hard drives. Follow these instructions to install a hard drive.

1. Press the locking lever latch and pull the locking lever open.



2. Slide the HDD tray out.

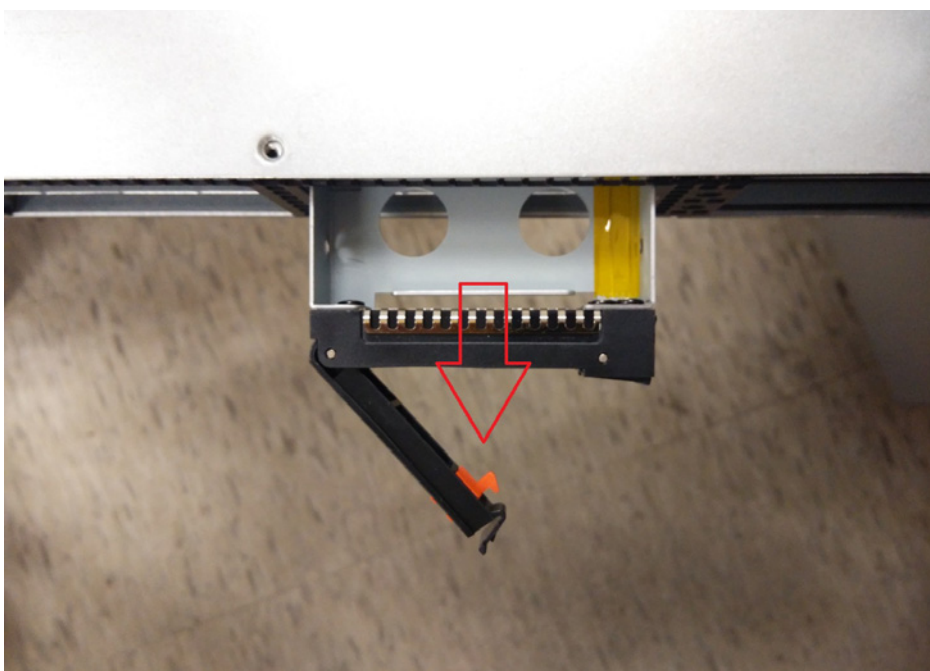

3. Place a hard drive into the drive tray, then use the screws to secure the HDD.



4. Reinsert the HDD tray into the chassis and press the locking lever to secure the tray.



2.2.5 Installing PCIe x16 Expansion Cards

(We use PCIe x16 double-depth GPU card as sample)

The AGS-910 supports three PCIe x16 expansion slots.

Please follow these instructions to install the expansion cards.

1. Unscrew the riser card cage and carefully place your fingers on the card cage holding positions.

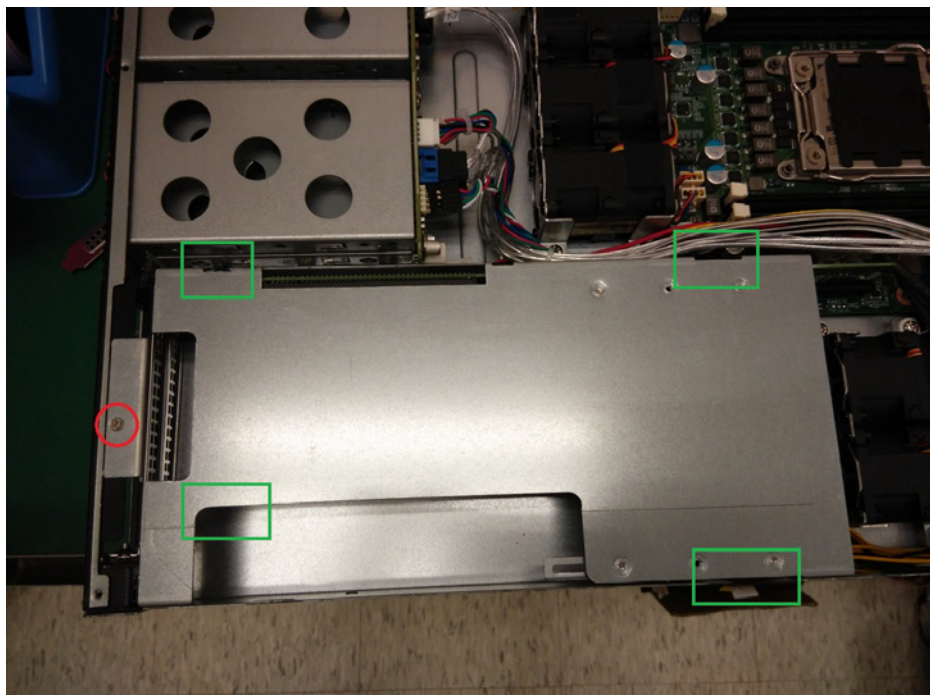

2. Take the card cage out from the chassis.

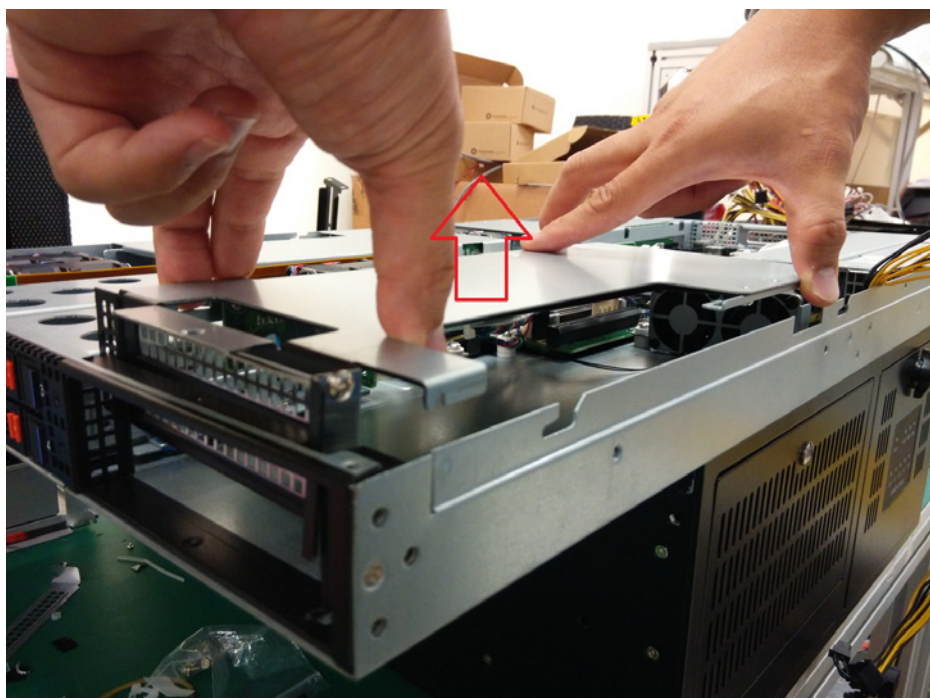

3. Release the expansion card holder.

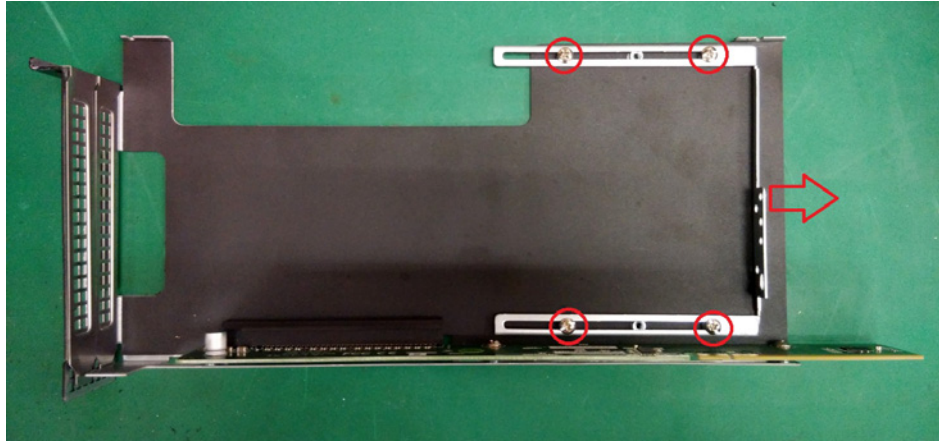

4. Unscrew the IO bracket from the card cage.



5. Install the expansion card into the card cage.

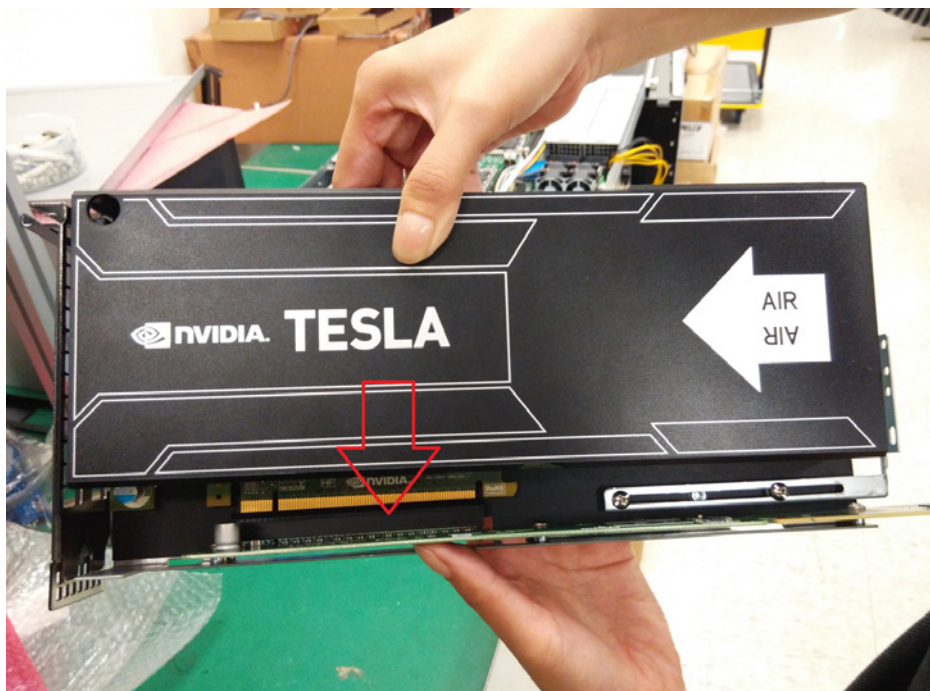

6. Screw the expansion card IO bracket onto the card cage.



7. Move the card holder toward to the expansion card.

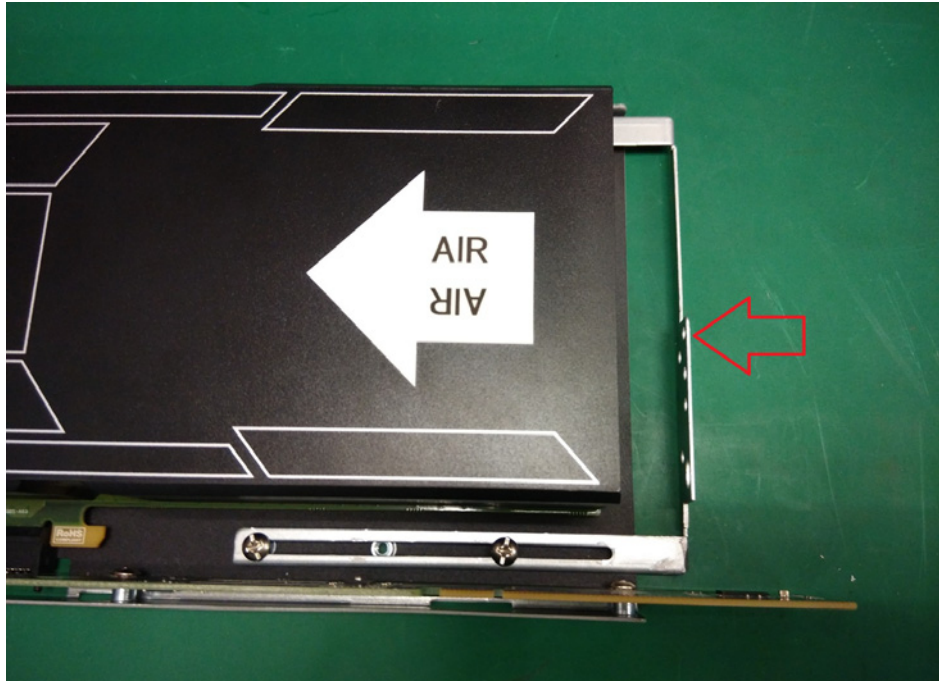

8. Screw the card holder onto the expansion card.



9. Connect the expansion card power cable to the expansion card power connector.

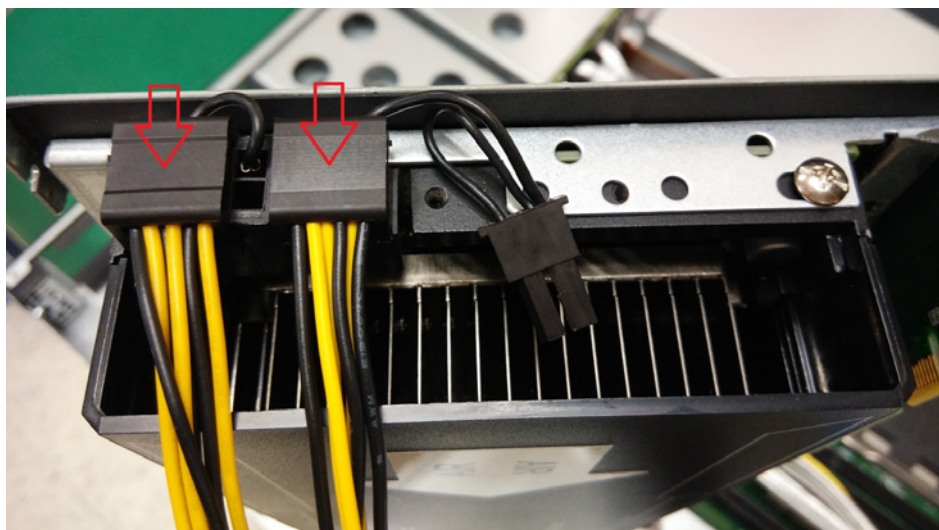

10. Put the card cage back into the chassis, and make sure the cage has no mechanical conflict with the chassis.

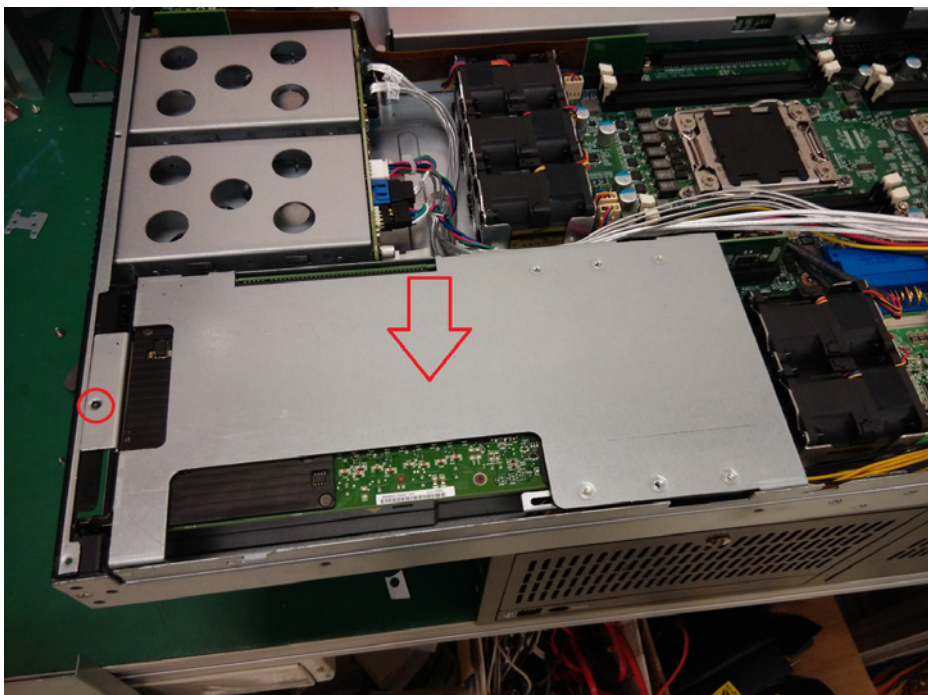

2.2.6 Installing PCIe x8 Expansion Card

(We use PCIe x8 mini SAS to SATA RAID card as sample)

The AGS-910 supports one PCIe x8 expansion slot.

Please follow these instructions to install the expansion cards.

1. Unscrew the riser card bracket and release the PCIe x8 riser card.

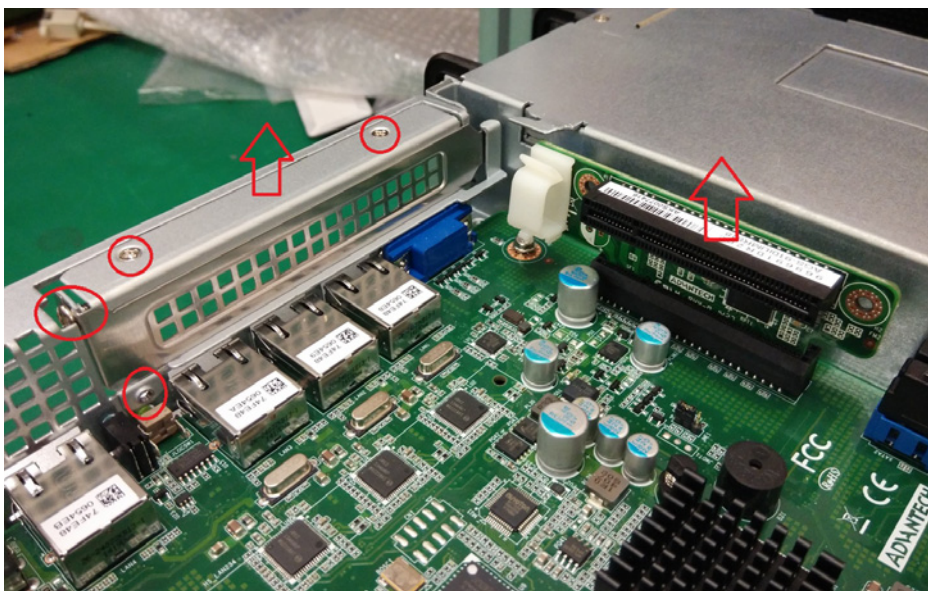

2. Screw the expansion card onto the riser card bracket.

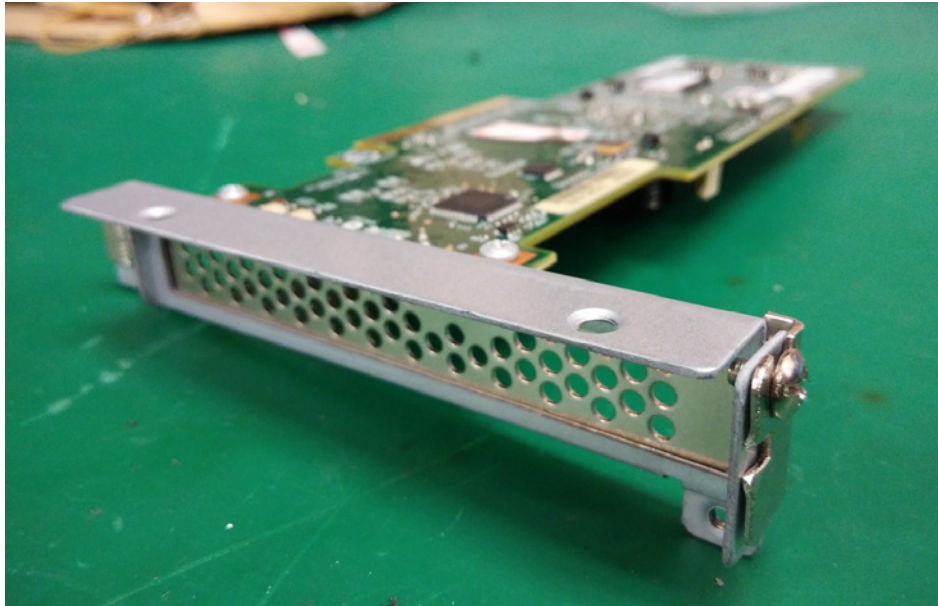

3. Install the expansion card onto the riser card.

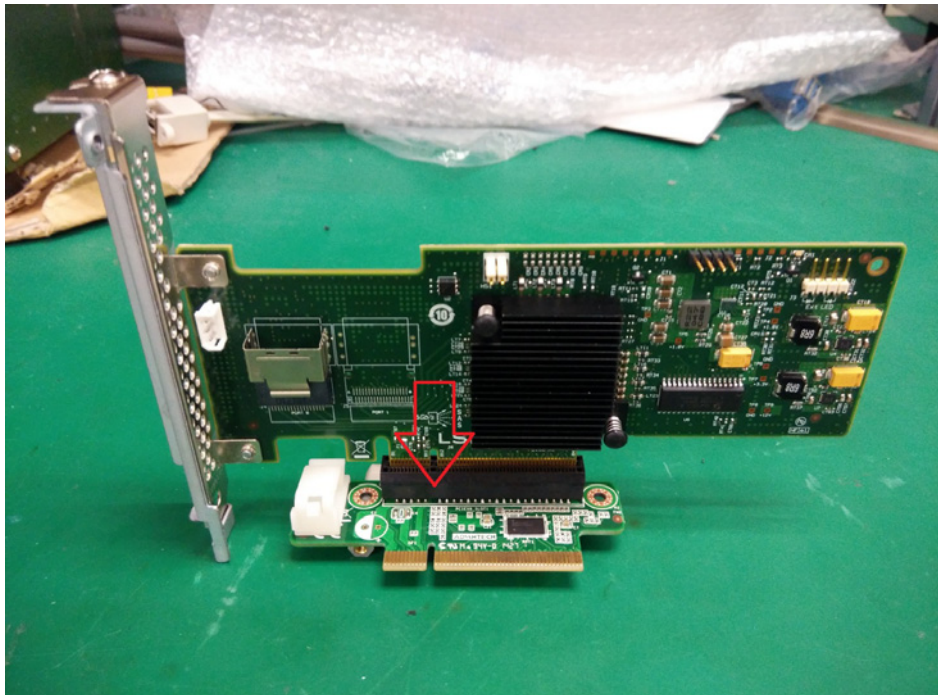

4. Install the mini SAS to SATA cable into the expansion card, then make the cable pass through the plastic clip.

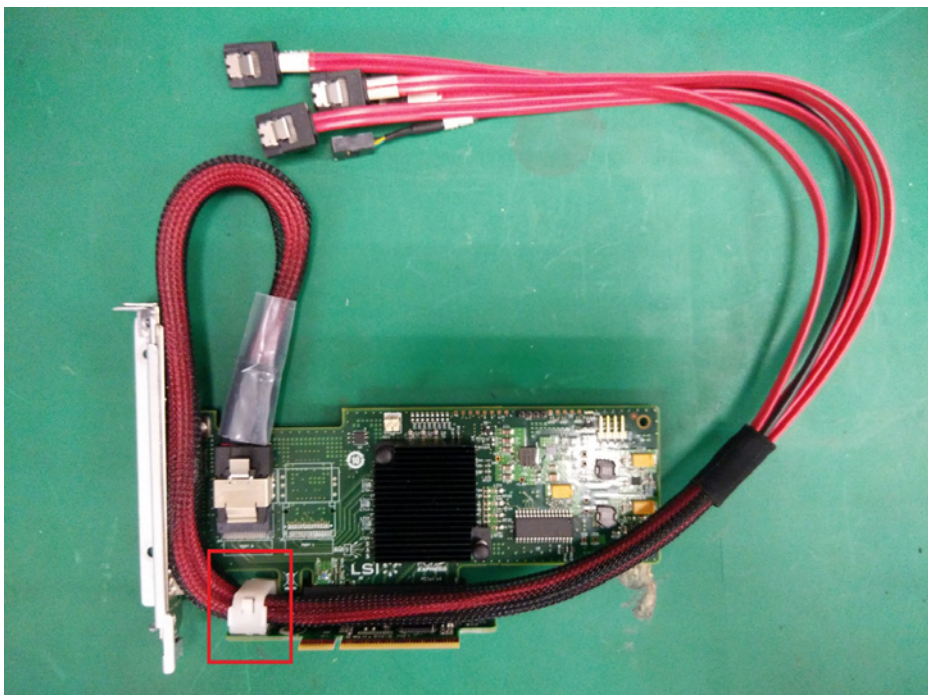

5. Install the expansion card into the chassis and secure it.

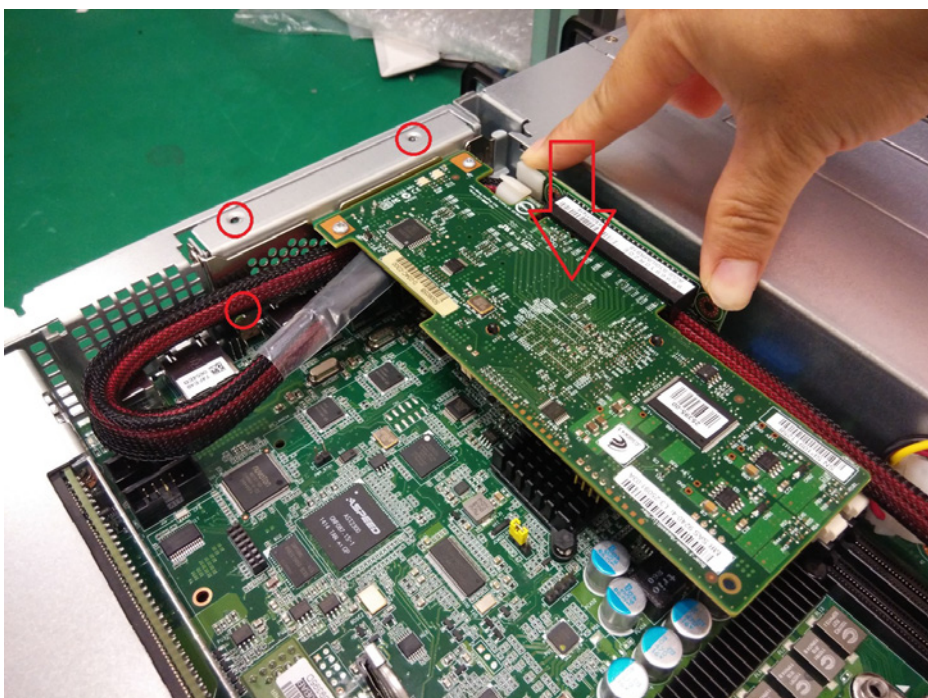

6. Remove the SATA / SATA SGPIO cable from the motherboard and HDD back plane.

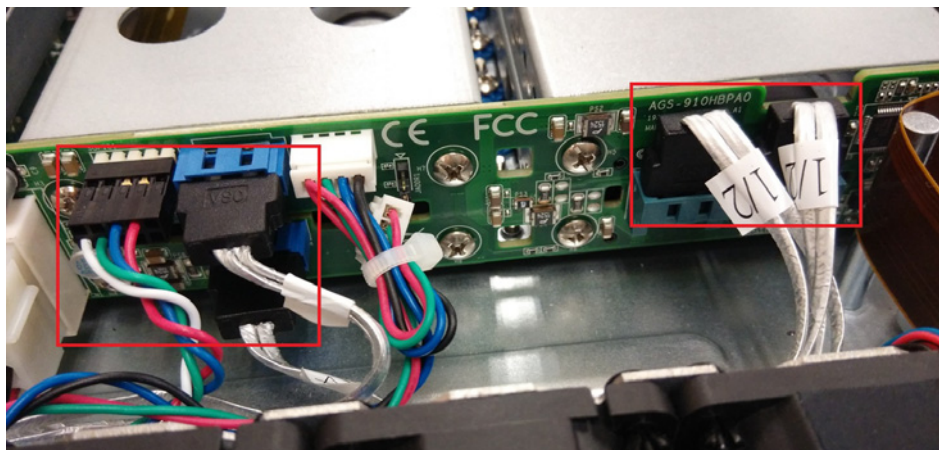
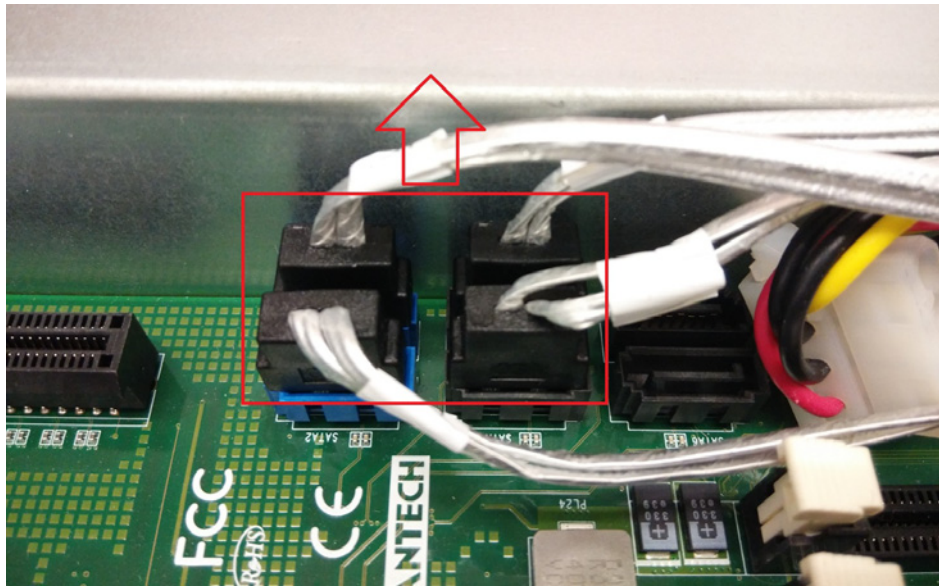

7. Install the SATA & SGPIO connector* into HDD back plane.

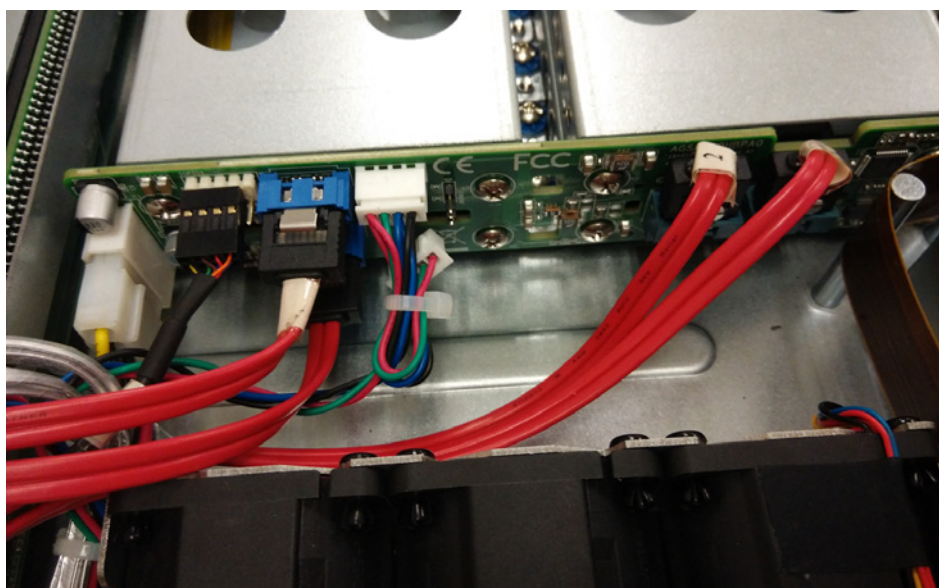

Please see SATA / SAS SGPIO pin header definition as below picture.

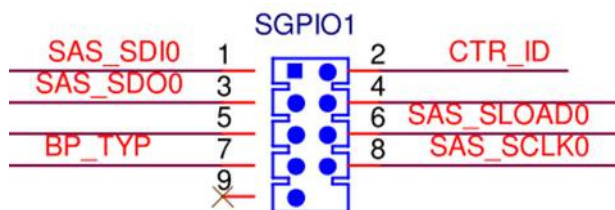

2.3 Rack Mounting

After installing the necessary components, the AGS-910 can be mounted in a rack using the supplied rack mounting kit.

We strongly recommend that the minimum depth of cabinets is 1000mm.

Rack mounting kit

- Sliding Rails x 2
- Convert bracket x 4
- Screws Kit x 3

2.3.1 Installing the Server in a Rack

Before mounting the AGS-910 in a rack, ensure that all internal components have been installed and that the unit has been fully tested.

Both side of chassis ear must be assembled before you assemble the slide rail kit.

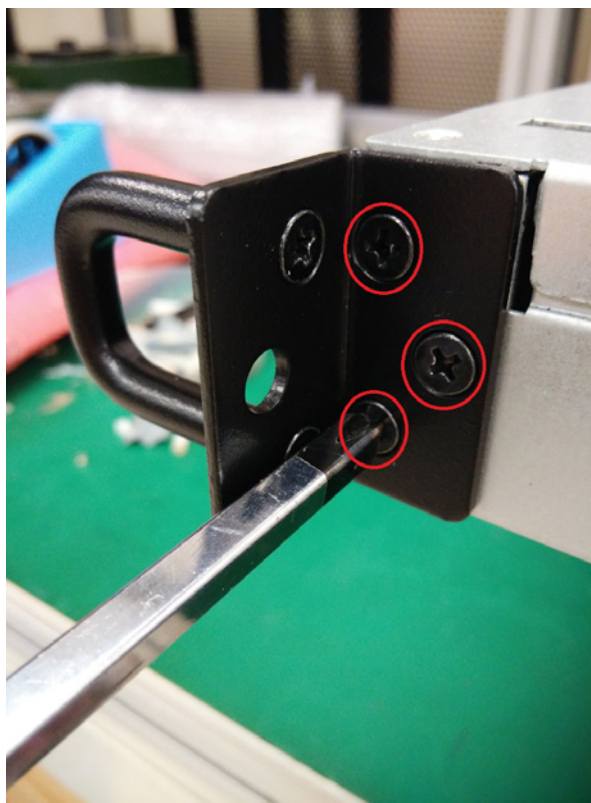

Follow these instructions to mount the AGS-910 into an industry standard 32" rack.

Screws list

M5 x16

M4 x9

1. Remove the chassis (inner) member.
Pull the slide open. Then press the trigger down as shown on the drawing, and pull the chassis (inner) member out.

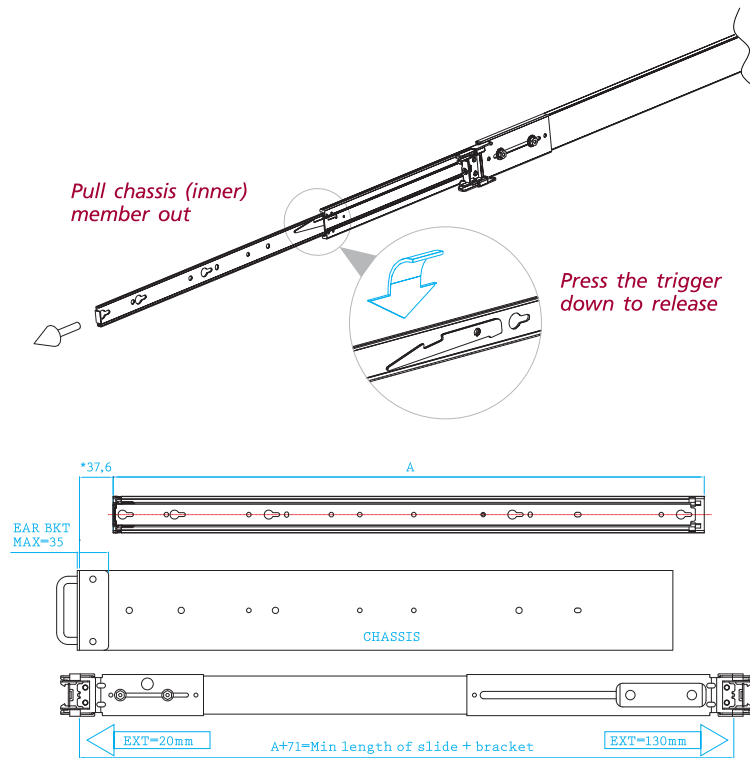

**Extendable front bracket only apply to some Tool-less model

2. Mount the chassis (inner) member to the chassis.
Each side of chassis uses 4 of screws or standoffs for slide attachment.

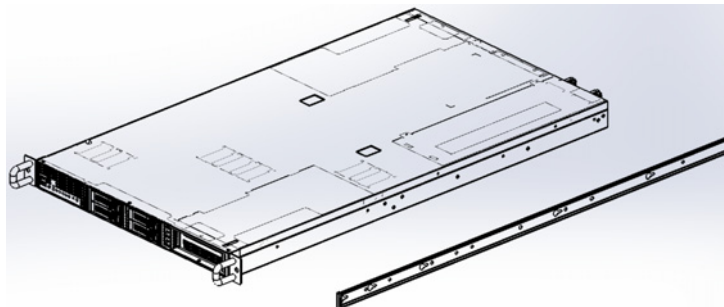

3. Attach the cabinet (outer) member to the rail.
Insert the stag into the upper and lower square holes on EIA rail from the back of rail. Push the safety lock forward to secure the bracket. It is important to check if the safety lock is in unlocked position before mounting the brackets.

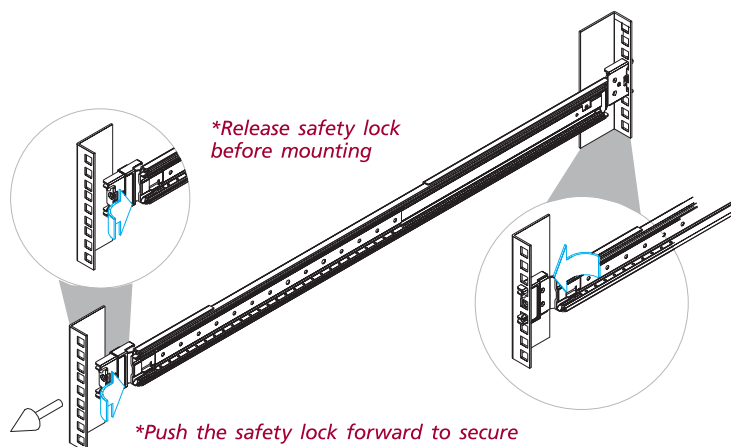

Uninstall the bracket

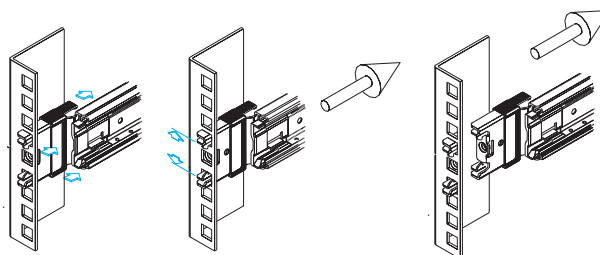

4. Mount the chassis into the cabinet.
Insert the chassis (inner) member into the cabinet member as shown on the drawing. It is important to check if the ball retainer is in fully open position before install the chassis. It might cause catastrophic damage to the chassis if ball retainer is not in fully open position while mounting the chassis. While you are pushing chassis back to the cabinet, you need to release the slide from locking position by pressing the trigger down.

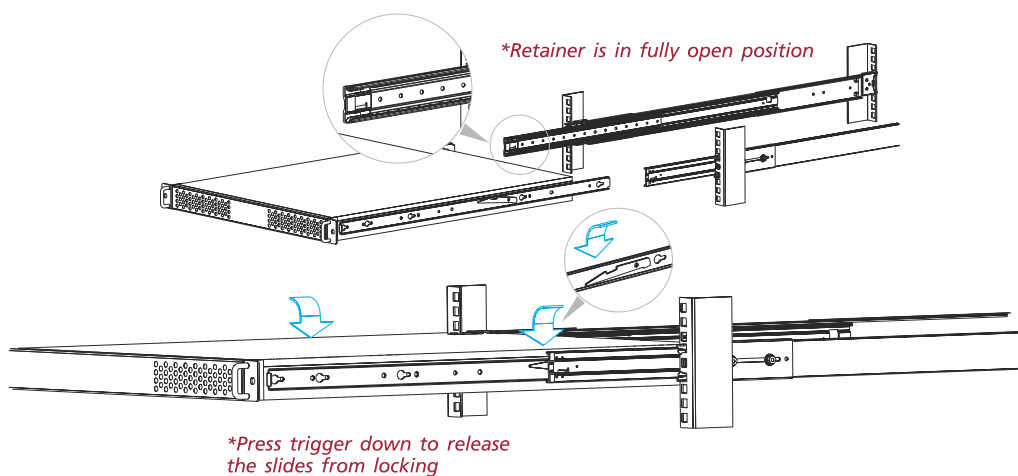

Note! *Rack Mount Instructions - The following or similar rack-mount instructions are included with the installation instructions:*



- *Elevated Operating Ambient - If installed in a closed or multi-unit rack assembly, the operating ambient temperature of the rack environment may be greater than room ambient. Therefore, consideration should be given to installing the equipment in an environment compatible with the maximum ambient temperature (Tma) specified by the manufacturer.*
- *Reduced Air Flow - Installation of the equipment in a rack should be such that the amount of air flow required for safe operation of the equipment is not compromised.*
- *Mechanical Loading - Mounting of the equipment in the rack should be such that a hazardous condition is not achieved due to uneven mechanical loading.*
- *Circuit Overloading - Consideration should be given to the connection of the equipment to the supply circuit and the effect that overloading of the circuits might have on overcurrent protection and supply wiring. Appropriate consideration of equipment nameplate ratings should be used when addressing this concern.*
- *Reliable Earthing - Reliable earthing of rackmounted equipment should be maintained. Particular attention should be given to supply connections other than direct connections to the branch circuit (e.g. use of power strips).*

Instructions de montage en rack - Le rack en suivant ou similaire - monter instructions sont incluses avec les instructions d'installation:

- *Température de fonctionnement élevée - il est installé dans une unité fermée ou plusieurs Ensemble formant bâti, la température ambiante de fonctionnement de l'environnement de l'armoire peut être supérieure à la chambre ambiante. Par conséquent, il devrait être donnée à l'installation de l'équipement dans un environnement compatible avec la température ambiante maximale (Tma) spécifiée par le fabricant.*
- *Débit d'air réduit - Installation de l'équipement dans un rack doit être tel que la quantité de flux d'air nécessaire au bon fonctionnement de l'appareil ne soit pas compromise.*
- *Chargement mécanique - Le montage de l'équipement dans le rack doit être telle qu'une situation dangereuse ne soit générée à inégale chargement mécanique.*
- *Surcharge du circuit - Il faut tenir compte à la connexion de l'équipement au circuit d'alimentation et l'effet que la surcharge des circuits pourrait avoir sur la protection contre les surintensités et le câblage d'alimentation. Considération appropriée de l'équipement plaque signalétique évaluations doivent être utilisés pour répondre à cette préoccupation.*
- *Fiabilité de la mise - Fiable mise à la terre de l'équipement monté en rack doit être maintenue. Une attention particulière devrait être accordée à fournir connexions autres que les connexions directes sur le circuit de branche (par exemple l'utilisation de multiprises).*

Chapter 3

AMI BIOS

3.1 Introduction

With the AMI BIOS Setup program, you can modify BIOS settings and control the special features of your system. The Setup program uses a number of menus for making changes and turning the special features on or off. This chapter describes the basic navigation of the AGS-910 setup screens.

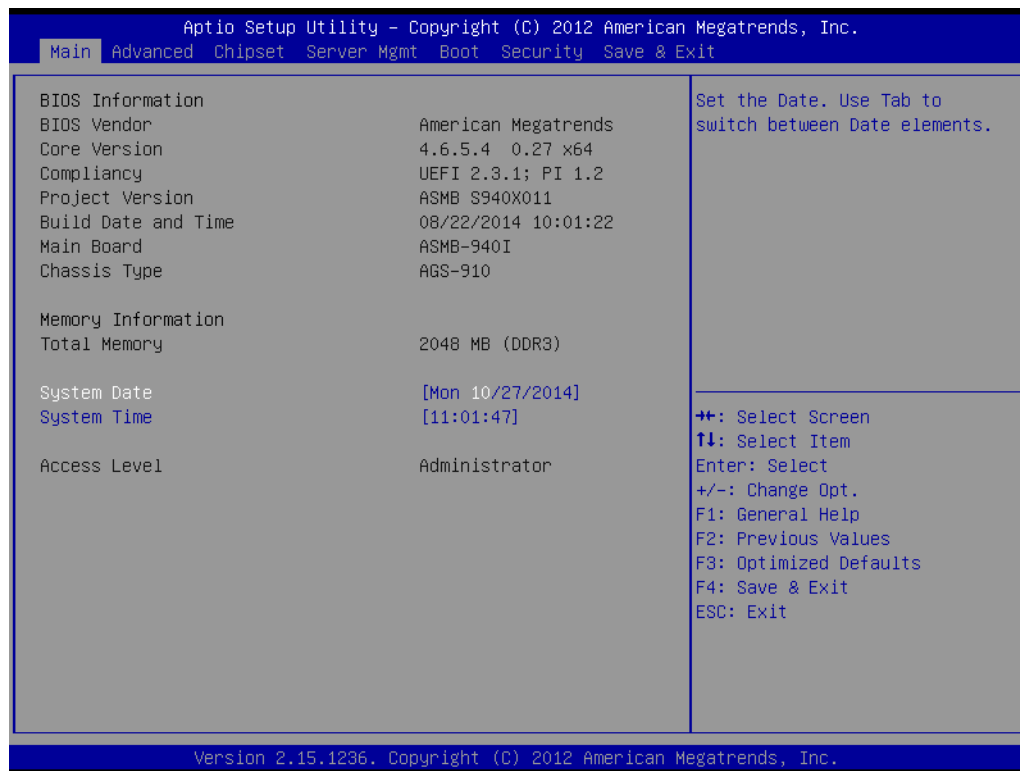

AMI's BIOS ROM has a built-in Setup program that allows users to modify the basic system configuration. This type of information is stored in battery-backed up CMOS so it retains the Setup information when the power is turned off.

Note! *The BIOS setup screens shown in this chapter are for reference only, they may not exactly match what you see on your display devices.*



3.2 BIOS Setup

3.2.1 Main Menu

Press during bootup to enter AMI BIOS CMOS Setup Utility; the Main Menu will appear on the screen. Use arrow keys to select among the items and press <Enter> to accept or enter the sub-menu.



The Main BIOS setup screen has two main frames. The left frame displays all the options that can be configured. Grayed-out options cannot be configured; options in blue can be. The right frame displays the key legend. Above the key legend is an area reserved for a text message. When an option is selected in the left frame, it is highlighted in white. Often a text message will accompany it.

■ System Time / System Date

Use this option to change the system time and date. Highlight System Time or System Date using the <Arrow> keys. Enter new values through the keyboard. Press the <Tab> key or the <Arrow> keys to move between fields. The date must be entered in MM/DD/YY format. The time must be entered in HH:MM:SS format.

3.2.2 Advanced BIOS Features Setup

Select the Advanced tab from the AGS-910 setup screen to enter the Advanced BIOS setup screen. You can select any of the items in the left frame of the screen, such as CPU configuration, to go to the sub menu for that item. You can display an Advanced BIOS Setup option by highlighting it using the <Arrow> keys. All Advanced BIOS Setup options are described in this section. The Advanced BIOS Setup screens are shown below. The sub menus are described on the following pages.

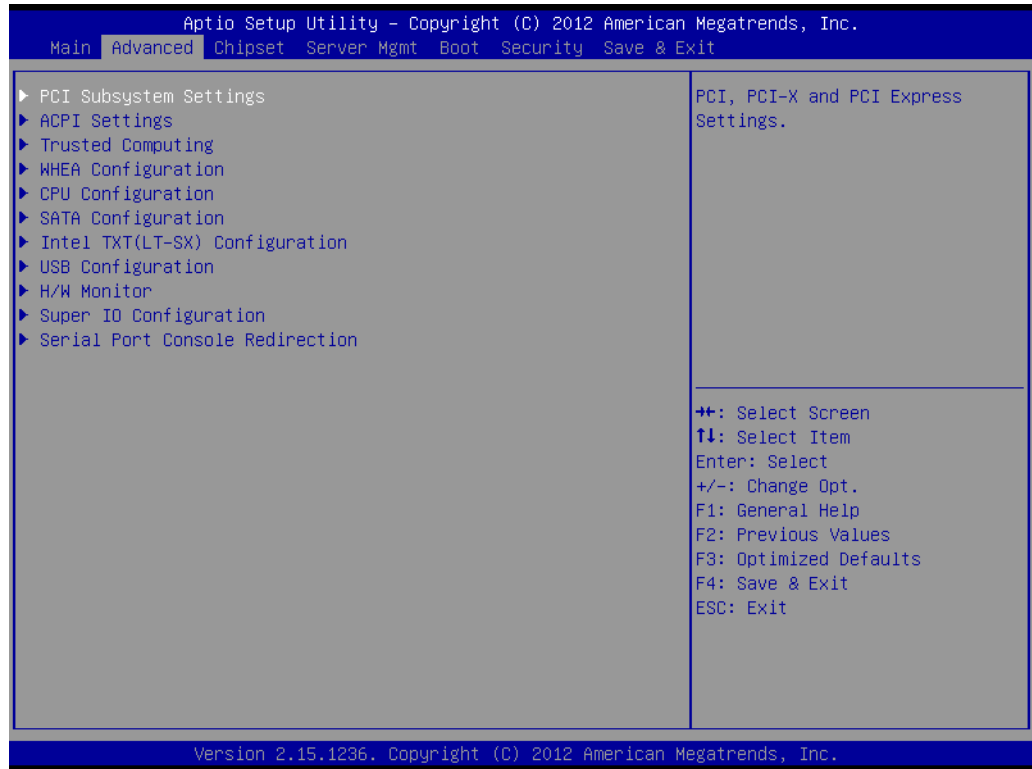

3.2.2.1 PCI Subsystem Settings

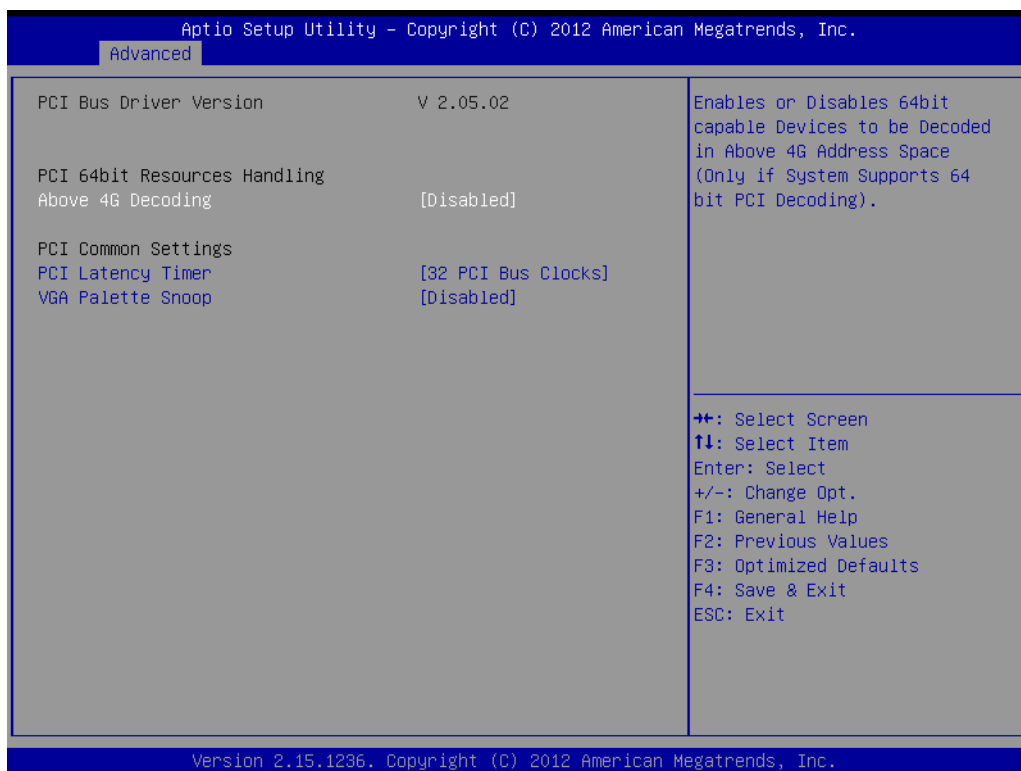

- **Above 4G Decoding**
Enables or disables 64-bit capability. Devices to be decoded in above 4G address space (Only if system supports 64-bit PCI decoding).
- **PCI Latency Timer**
Value in units of PCI clocks for PCI device latency timer register.
- **VGA Palette Snoop**
Enables or disables VGA palette register snooping.

3.2.2.2 ACPI Settings



- **Enable Hibernation**
"Enable or disable" Hibernation.
- **ACPI Sleep State**
Specifies the ACPI sleep state when the system enters standby.
- **Lock Legacy Resources**
"Enable" or "Disable" Lock Legacy Resources.

3.2.2.3 Trusted Computing

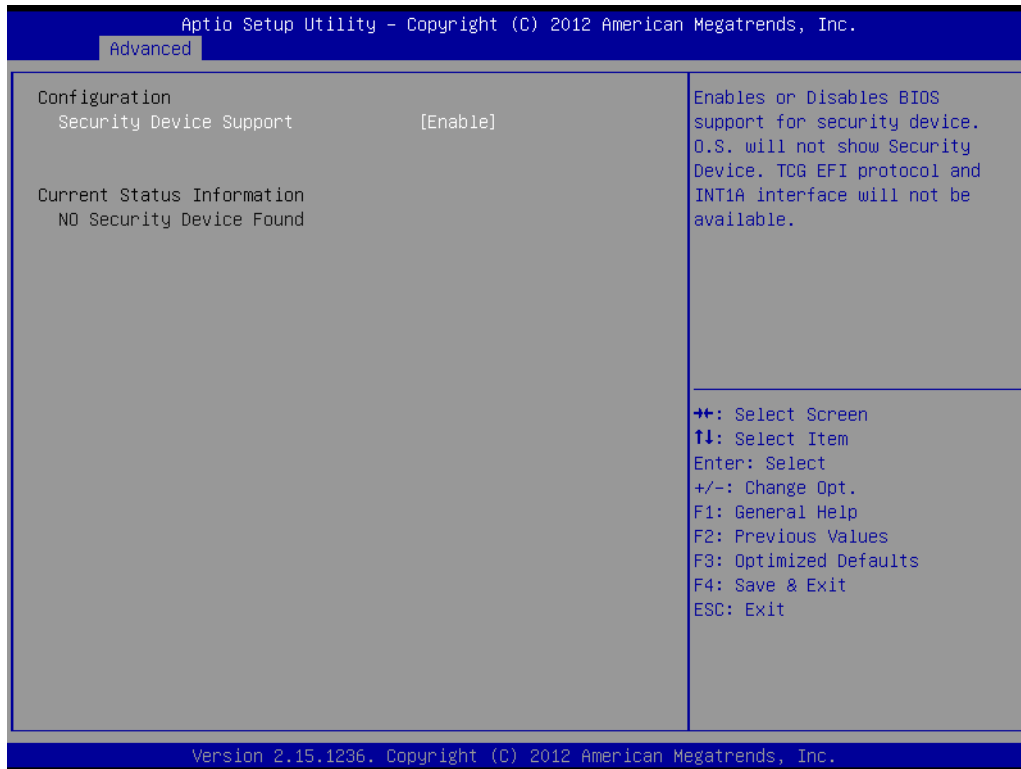

- **Security Device Support**
Enables or disables BIOS support for security device.
Purchase Advantech LPC TPM module to enable TPM function. P/N: PCATPM-00A1E.

3.2.2.4 WHEA Support

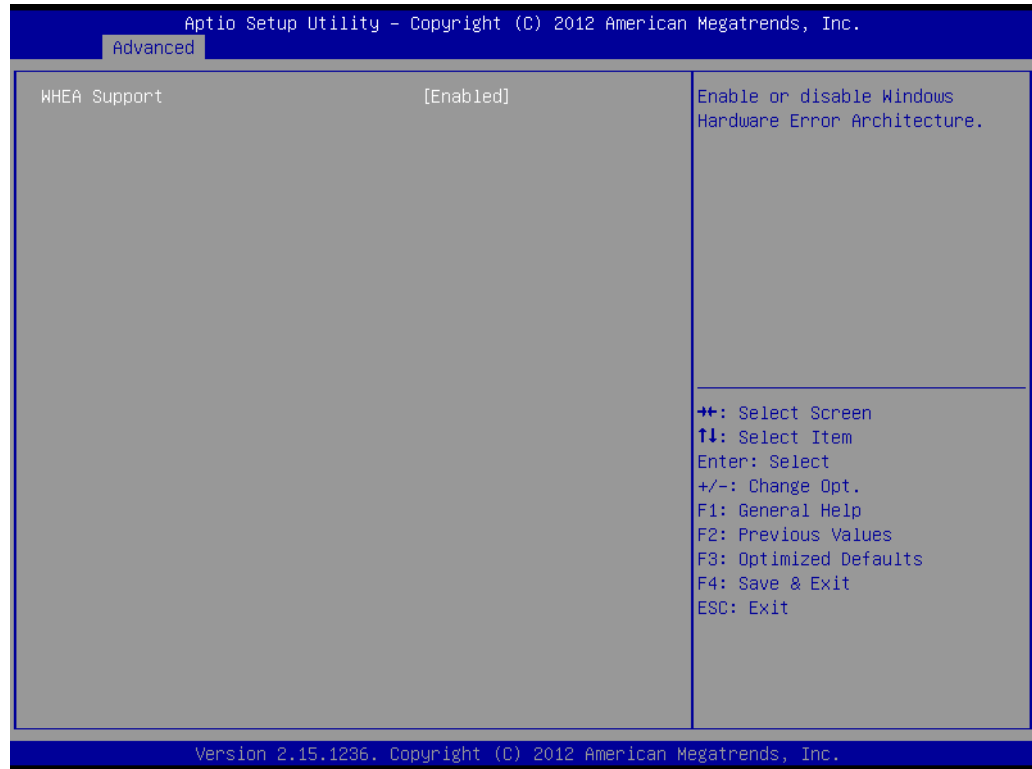

- **WHEA Support**
"Enable or disable" Windows Hardware Error Architecture.

3.2.2.5 CPU Configuration

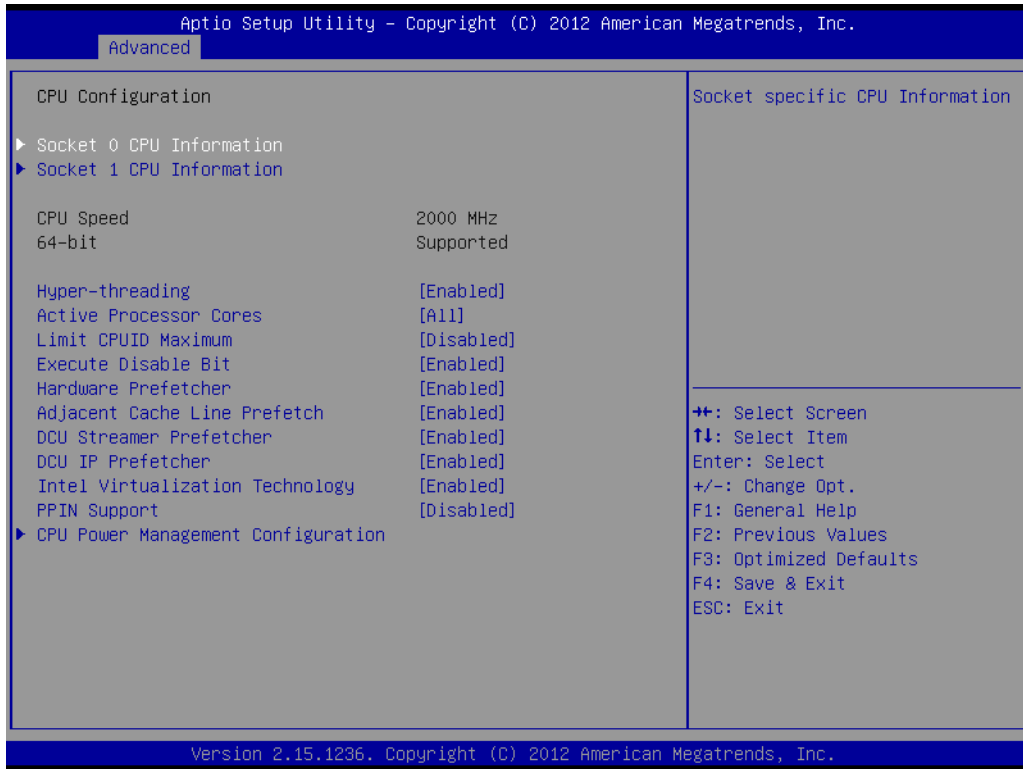

■ Socket 0/Socket 1 CPU Information

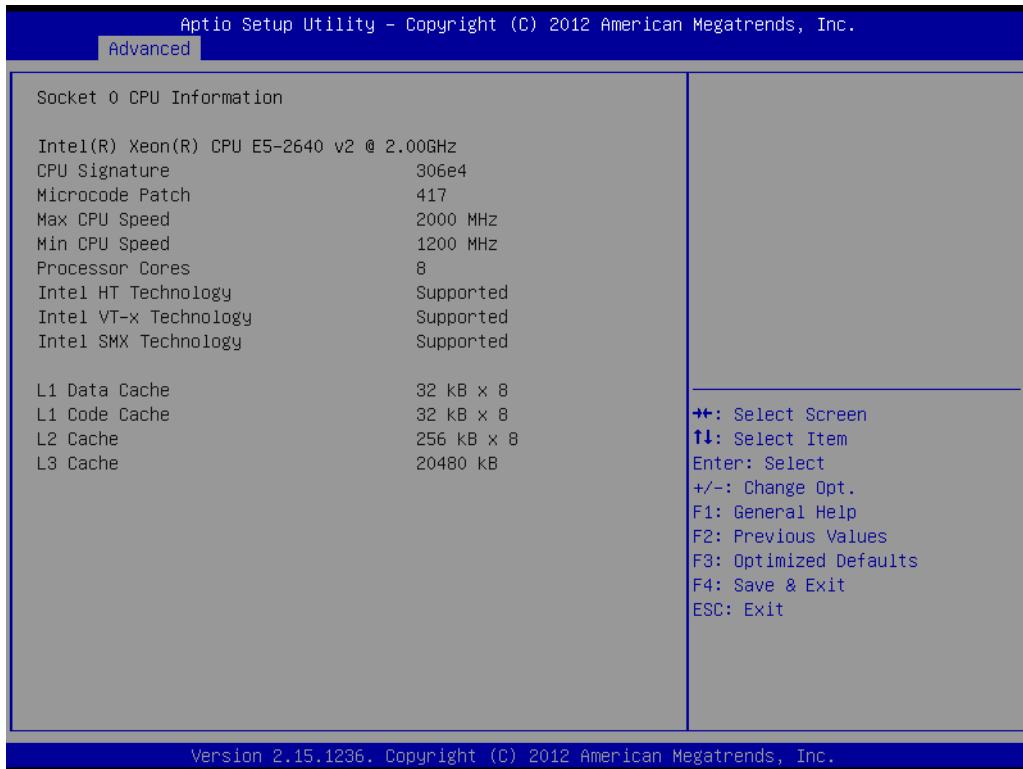

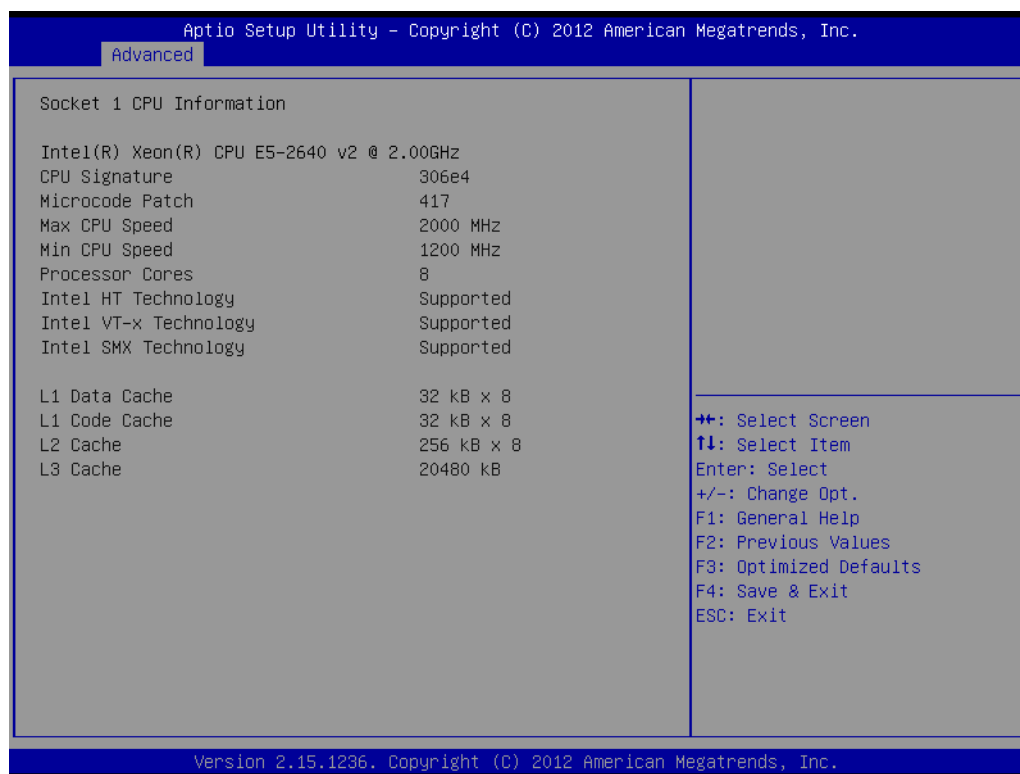

- **Hyper-threading**
Enable or disable Intel Hyper Threading technology.
- **Active Processor Core**
Select how many processor cores to activate when using a dual or quad core processor.
- **Limit CPUID Maximum**
Set this item to [Enable] allows legacy operating systems to boot even without support for CPUs with extended CPUID functions.
- **Execute Disable Bit**
This item specifies the Execute Disable Bit Feature. The settings are Enabled and Disabled. The Optimal and Fail-Safe default setting is Enabled. If Disabled is selected, the BIOS forces the XD feature flag to always return to 0.
- **Hardware Prefetcher**
Hardware Prefetcher is a technique that fetches instructions and/or data from memory into the CPU cache memory well before the CPU needs it, so that it can improve the load-to-use latency. Set to enable or disable.
- **Adjacent Cache Line Prefetch**
The Adjacent Cache-Line Prefetch mechanism, like automatic hardware prefetch, operates without programmer intervention. When enabled through the BIOS, two 64- byte cache lines are fetched into a 128-byte sector, regardless of whether the additional cache line has been requested or not. Set to enable or disable.
- **DCU Streamer Prefetch**
Enable prefetch of next L1 data line based upon multiple loads in same cache line.
- **DCU IP Prefetcher**
Enable prefetch of next L1 line based upon sequential load history.

- **Intel® Virtualization Technology**

This feature is used to enable or disable the Intel Virtualization Technology (IVT) extension. It allows multiple operating systems to run simultaneously on the same system. It does this by creating virtual machines, each running its own x86 operating system.

- **CPU Power Management Configuration**

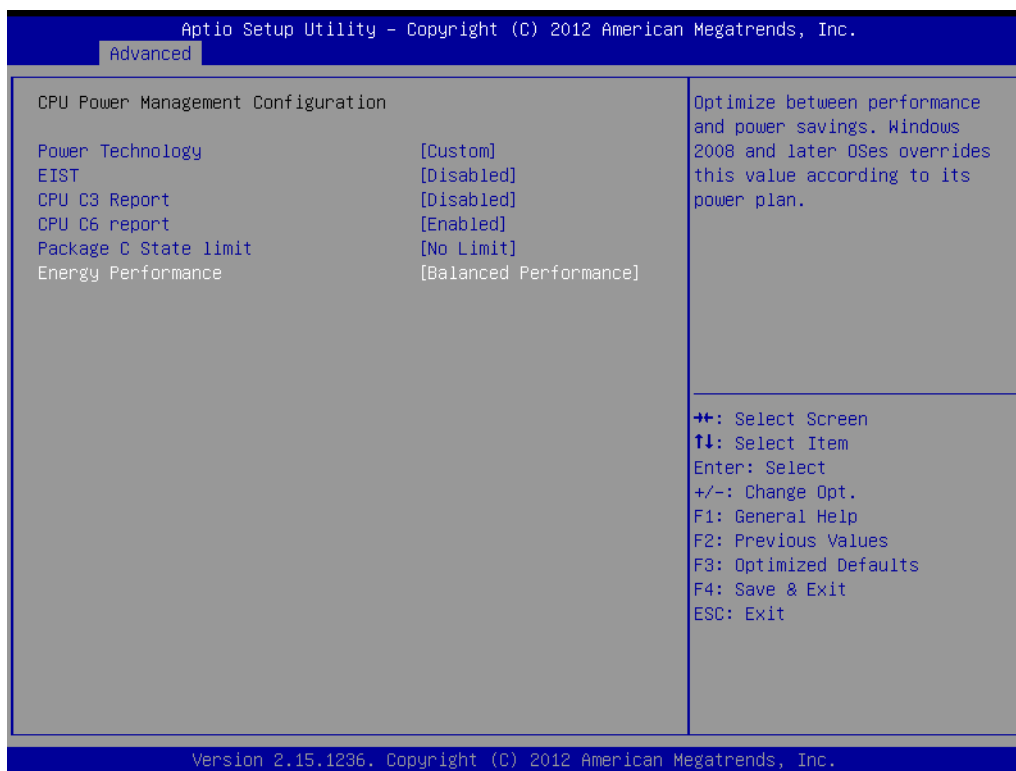

Power technology default is “Energy Efficient”.

User can set “EIST”, “P-STATE”, “C3”, “C6”, “Package C State limit” under “Custom” Mode.

3.2.2.6 SATA Configuration

- **SATA Mode**
Configured as IDE/RAID/AHCI or Disabled.
- **IDE Mode**

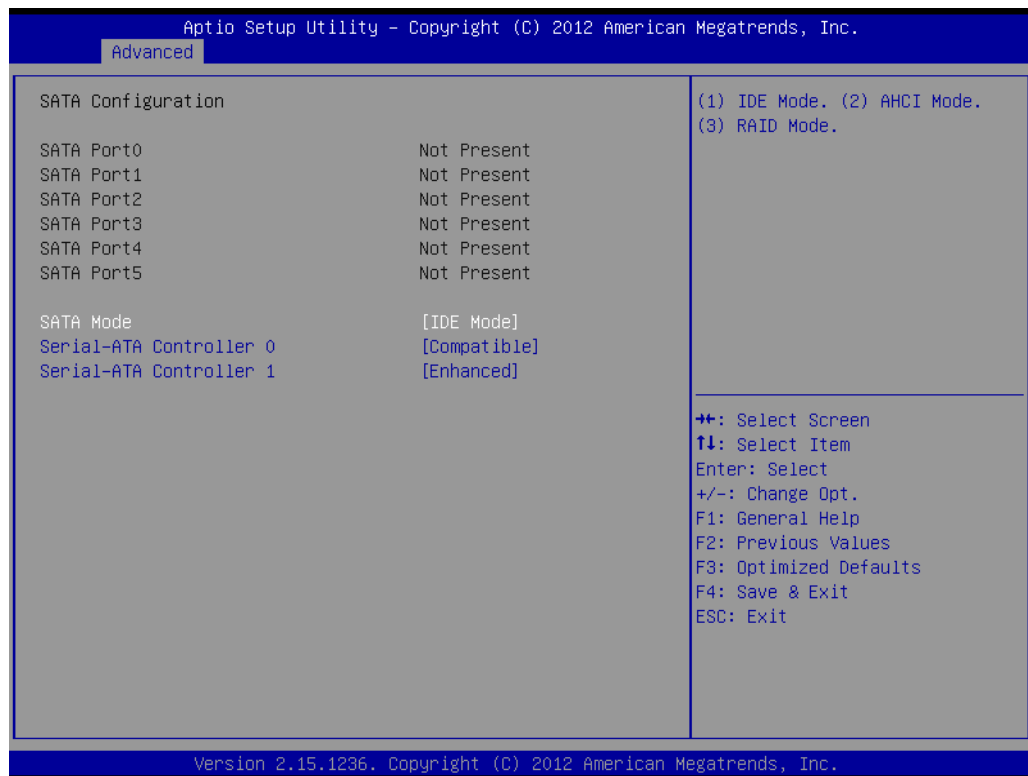

– **Serial-ATA Controller 0**

This item appears only when SATA Mode item set to [IDE Mode]. Set to [Enhanced] to support two SATA 6.0 Gb/s and four SATA 3.0 Gb/s devices. Set to [Compatible] when using Windows 98/NT/2000/MS-DOS. Up to four SATA devices are supported by controller 0 and two SATA devices are supported by controller 1 when under these operating systems.

– **Serial-ATA Controller 1**

This item appears only when SATA Mode item to [IDE Mode] is set. Set to [Enhanced] to support two SATA 3.0 Gb/s devices.

■ AHCI Mode

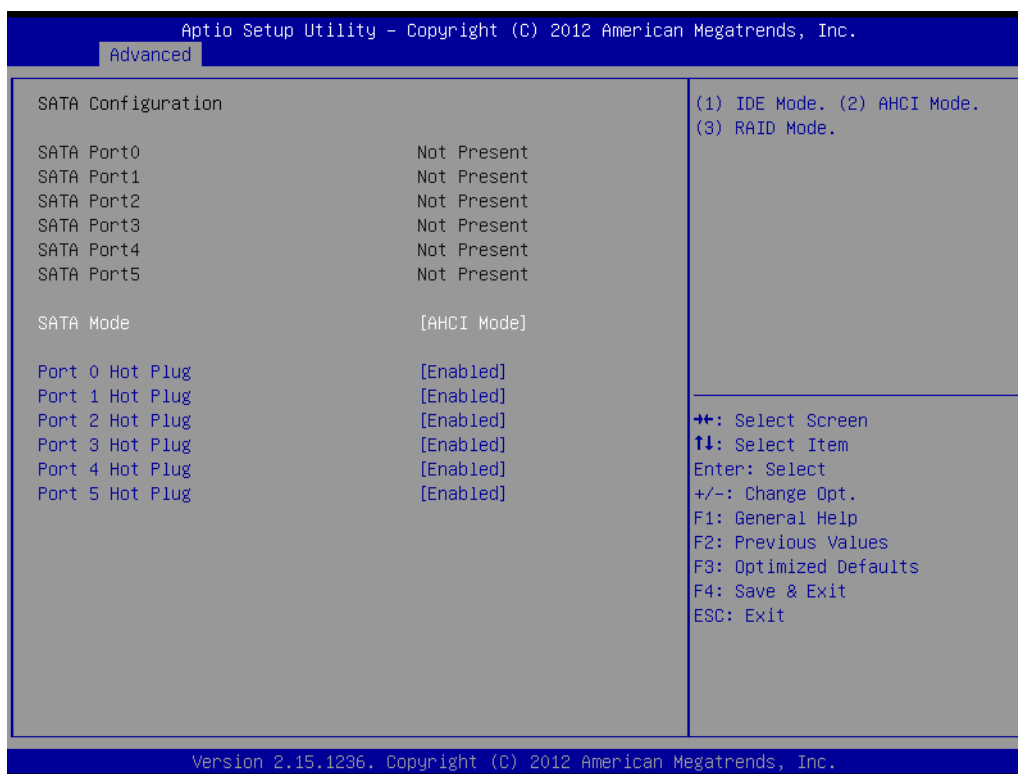

Set to [AHCI Mode] to have the SATA hard disk drives use the AHCI (Advanced Host Controller Interface). The AHCI allows the onboard storage driver to enable advanced Serial ATA features that increase storage performance on random workloads by allowing the drive to internally optimize the order of commands.

■ RAID Mode

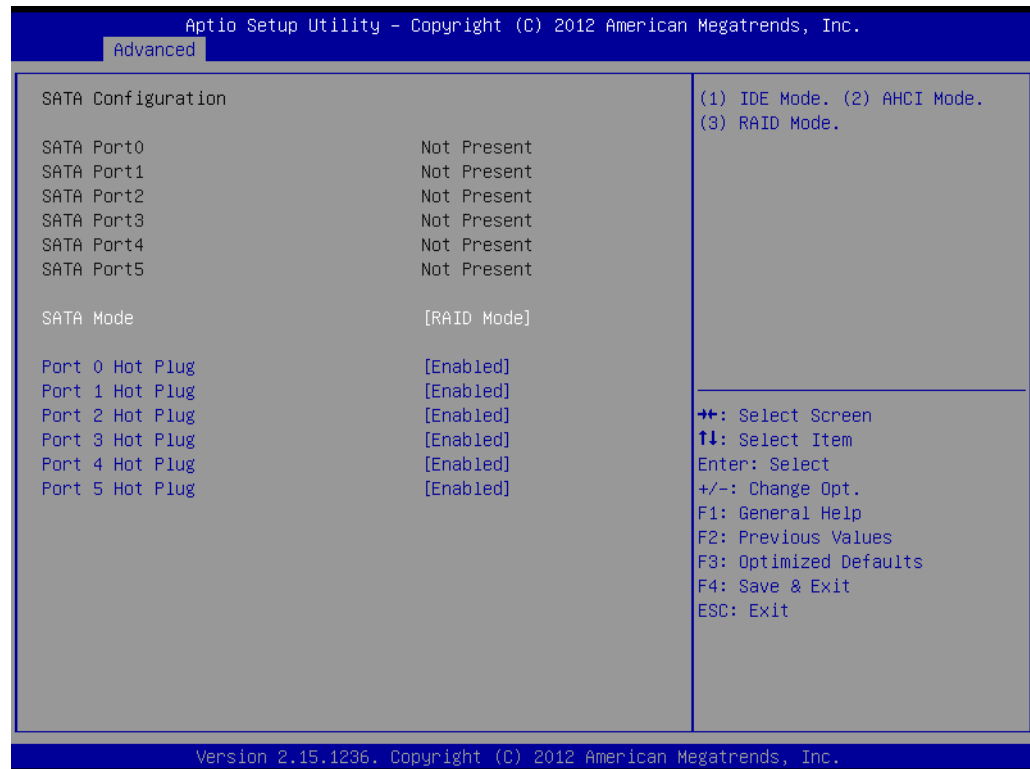

Set to [RAID Mode] to create a RAID configuration from the SATA hard disk drives.

3.2.2.7 Intel TXT(LT-SX) Configuration

This item shows Intel trusted execution technology configuration.

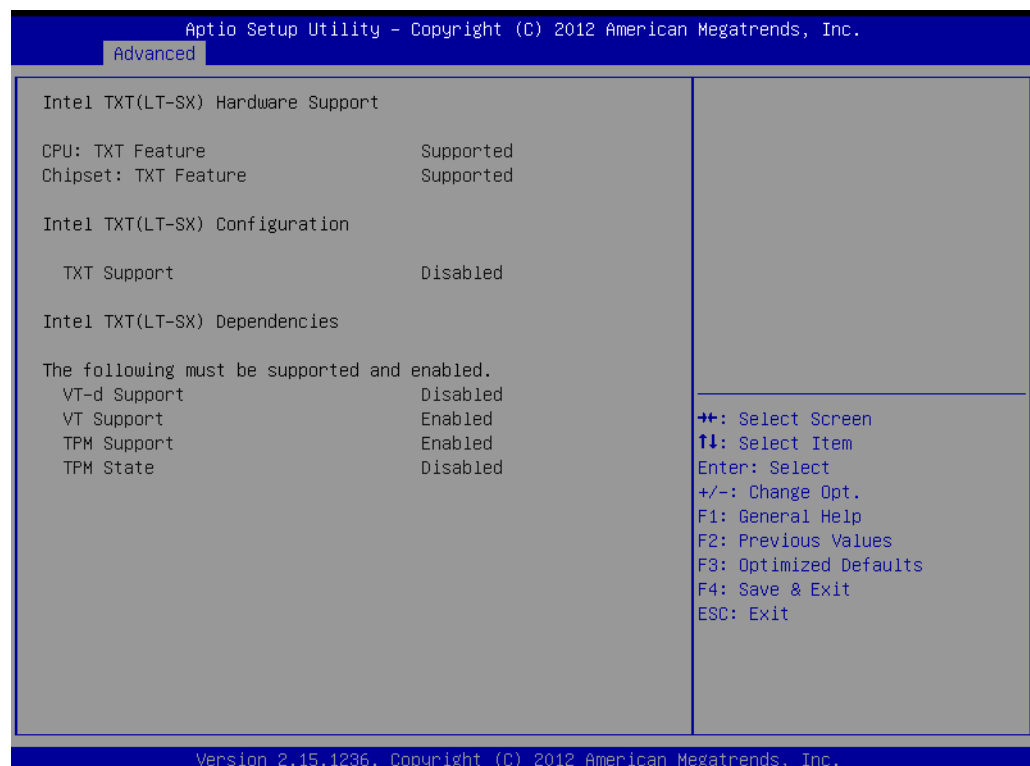

3.2.2.8 USB Configuration

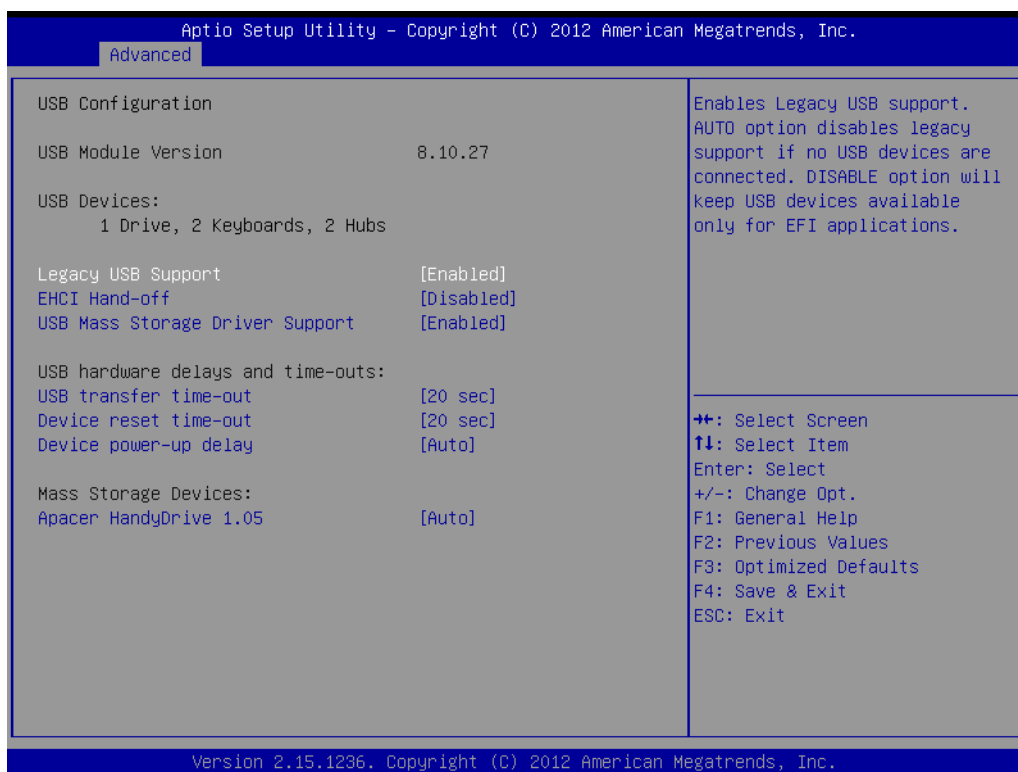

- **Legacy USB Support**
 This is for supporting USB device under a legacy OS such as DOS. When choosing "AUTO", the system will automatically detect if any USB device is plugged into the computer and enable USB legacy mode when a USB device is plugged and disable USB legacy mode when no USB device is attached.
- **EHCI Hand-off**
 This is a workaround for OS without EHCI hand-off support.
 The EHCI ownership change should be claimed by EHCI driver.
- **USB Mass Storage Driver Support**
 Enable/Disable USB mass storage driver support.
- **USB Transfer Time-out**
 Selects the USB transfer time-out value. [1,5,10,20sec]
- **Device Reset Time-out**
 Selects the USB device reset time-out value. [10,20,30,40 sec]
- **Device Power-up Delay**
 This item appears only when Device power-up delay item is set to [manual].

3.2.2.9 H/W Monitor

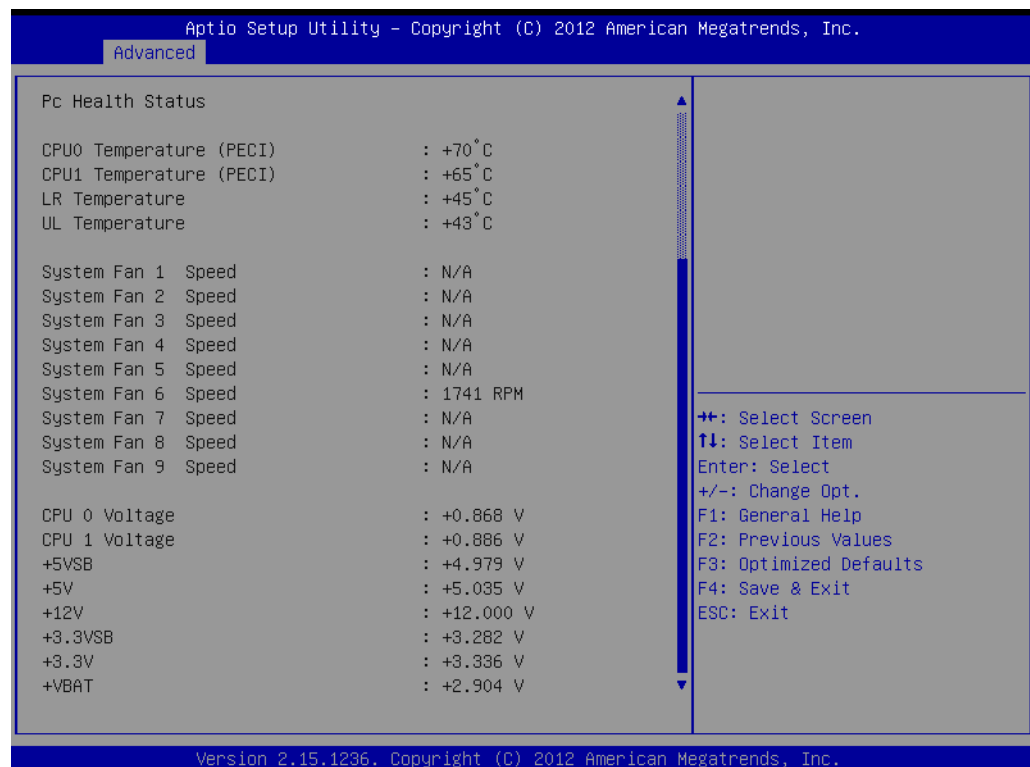
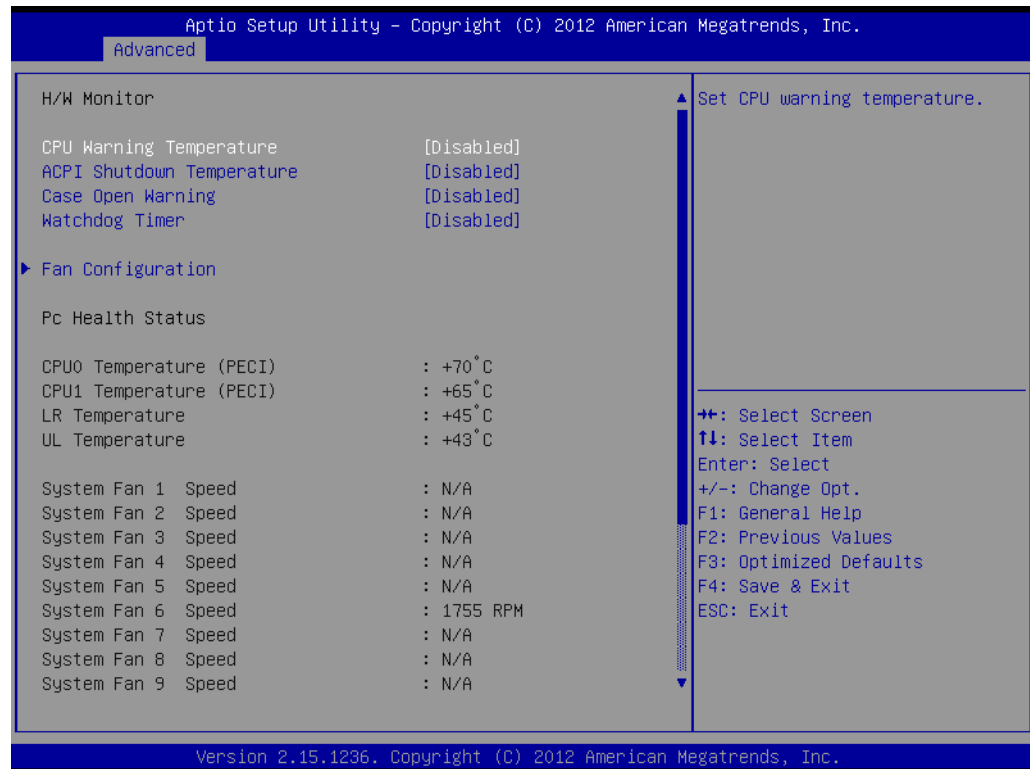

- **Case Open Warning**
 Enable/Disable the Chassis Intrusion monitoring function. When enabled and the case is opened, the warning message will show in POST screen.
- **Watchdog Timer**
 Enable and Disable the watchdog timer function.

- **CPU Warning Temperature**
Set the CPU warning temperature threshold. When the system reaches the warning temperature, the speaker will beep.
- **ACPI Shutdown Temperature**
Set the ACPI shutdown temperature threshold. When the system reaches the shutdown temperature, it will be automatically shut down by ACPI OS to protect the system from overheat damage.
- **Smart Fan Mode Configuration**
When set to manual mode, fan duty setting can be changed; the range is from 30%~100%, default setting is 50%.

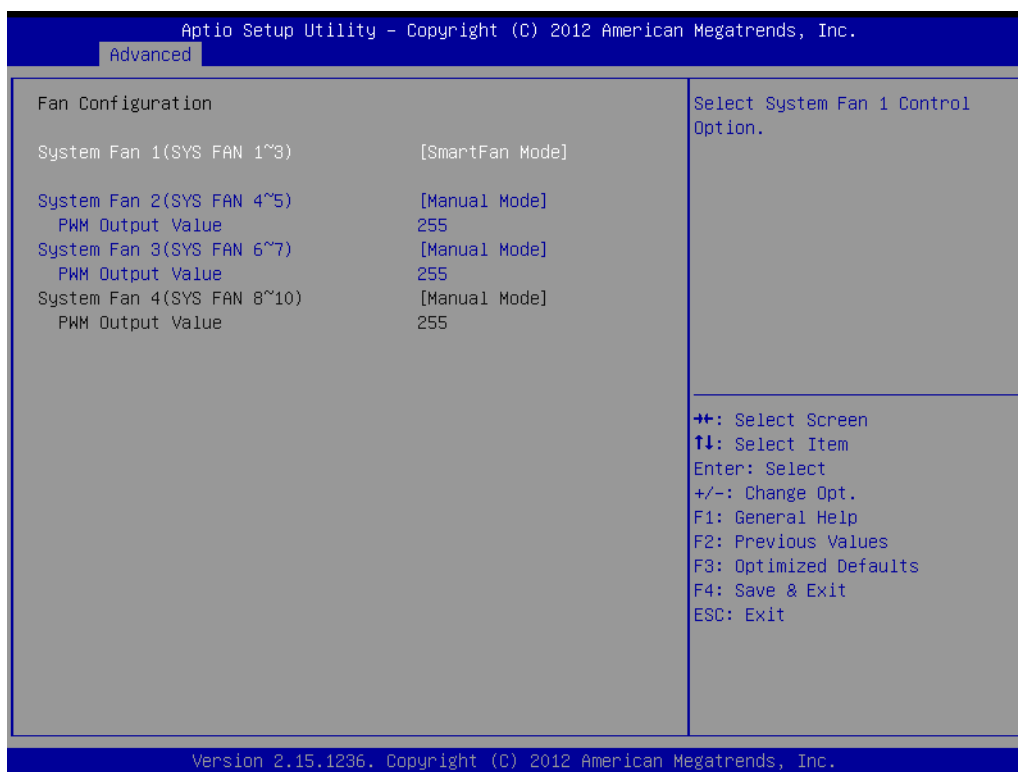

3.2.2.10 Super I/O Configuration

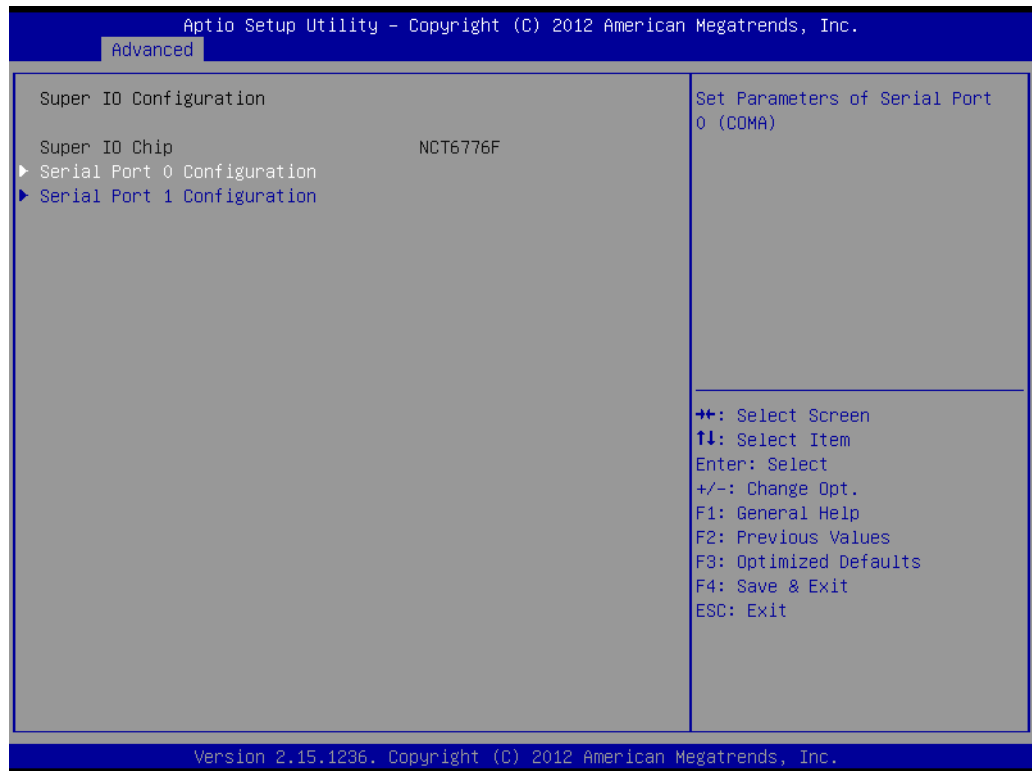

■ Serial Port 0 Configuration

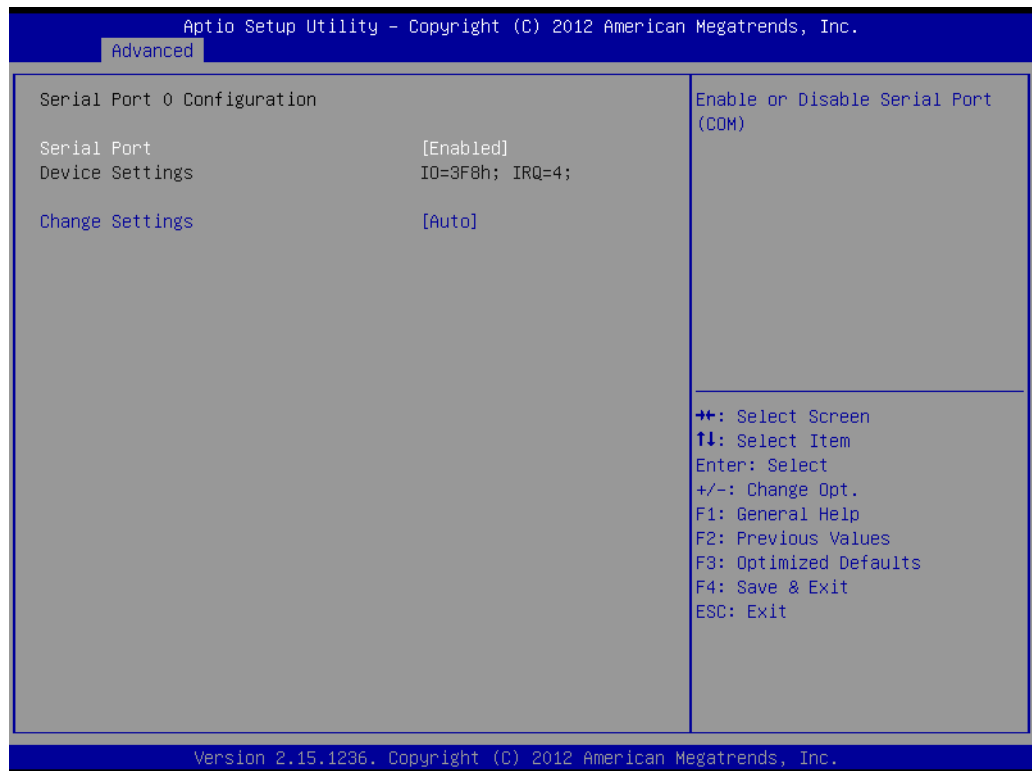

- **Serial Port**
“Enable” or “Disable” Serial Port 0.
- **Change Settings**
To select an optimal setting for serial port 0.

■ Serial Port 1 Configuration

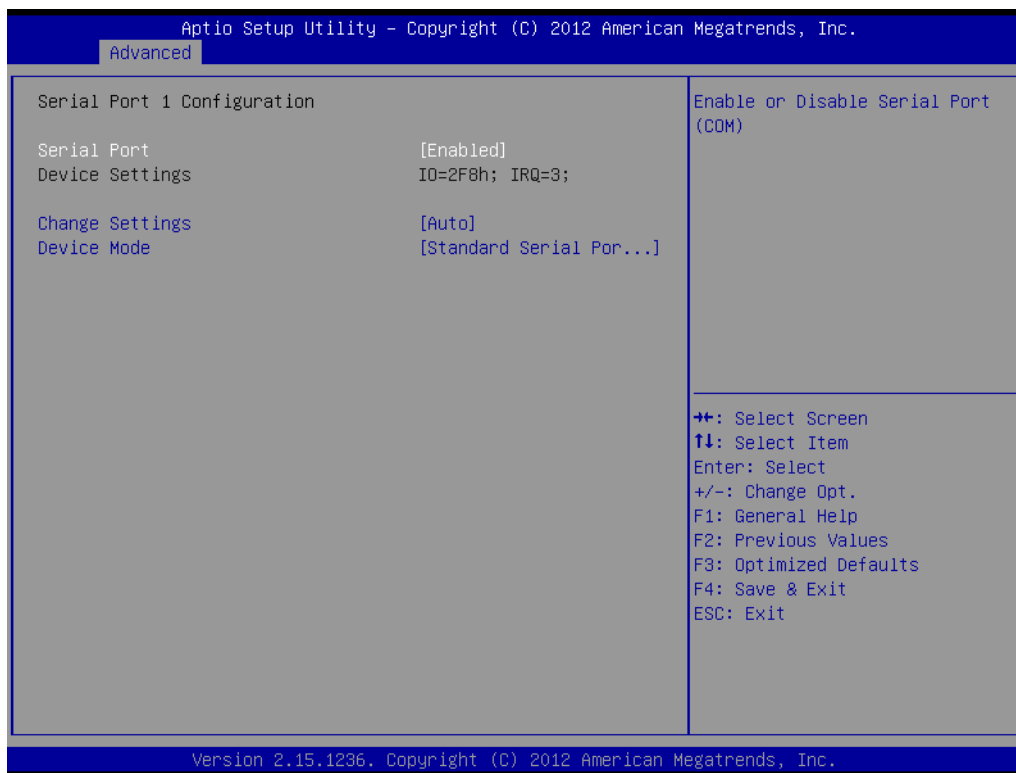

- **Serial Port**
“Enable” or “Disable” Serial Port 1.
- **Change Settings**
To select an optimal setting for serial port 1.

3.2.2.11 Serial Port Console Redirection

■ Console Redirection

To “Enable or disable” console redirection feature.

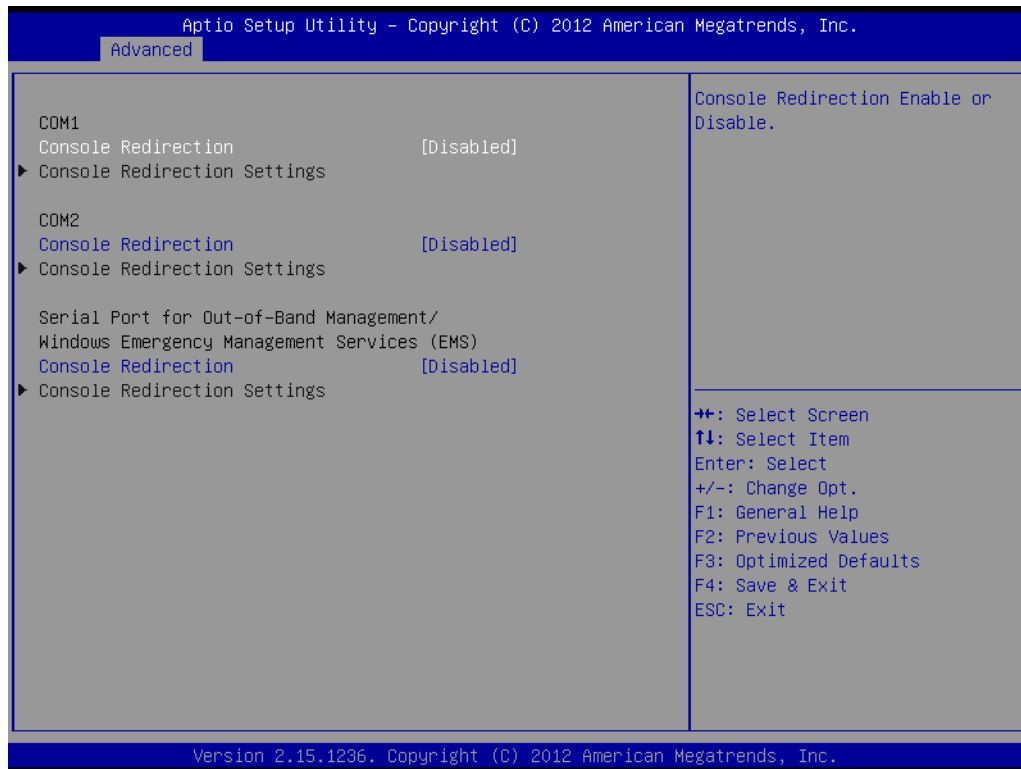

■ Console Redirection Settings

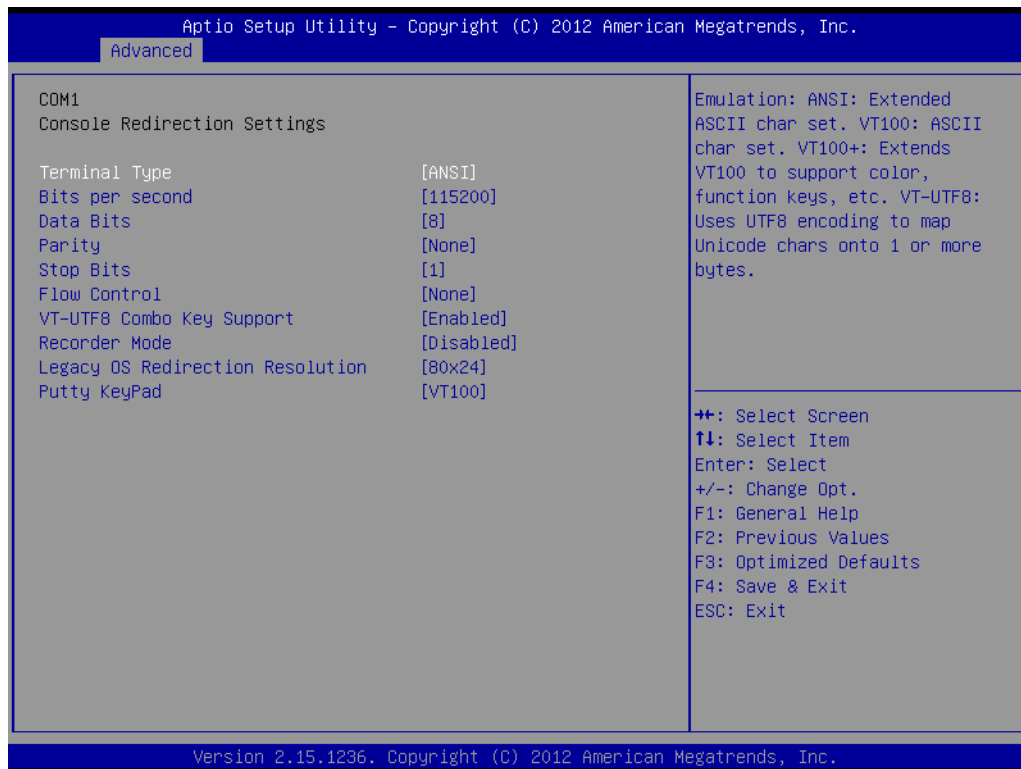

- **Terminal Type**
Select a terminal type to be used for console redirection.
Options available: VT100/VT100+/ANSI /VT-UTF8.
- **Bits Per Second**
Select the baud rate for console redirection.
Options available: 9600/19200/57600/115200.
- **Parity**
A parity bit can be sent with the data bits to detect some transmission errors.
Even: parity bit is 0 if the number of 1's in the data bits is even.
Odd: parity bit is 0 if number of 1's the data bits is odd.
Mark: parity bit is always 1. Space: Parity bit is always 0.
Mark and Space Parity do not allow for error detection.
Options available: None/Even/Odd/Mark/Space.
- **Stop Bits**
Stop bits indicate the end of a serial data packet. (A start bit indicates the beginning).
The standard setting is 1 stop bit. Communication with slow devices may require more than 1 stop bit.
Options available: 1/2.
- **Flow Control**
Flow control can prevent data loss from buffer overflow. When sending data, if the receiving buffers are full, a 'stop' signal can be sent to stop the data flow. Once the buffers are empty, a 'start' signal can be sent to re-start the flow. Hardware flow control uses two wires to send start/stop signals.
Options available: None/Hardware RTS/CTS.
- **Recorder Mode**
When this mode enabled, only text will be send. This is to capture Terminal data.
Options available: Enabled/Disabled.
- **Legacy OS Redirection Resolution**
On Legacy OS, the number of Rows and Columns supported redirection.
Options available: 80x24/80X25.
- **Putty Keypad**
Select function key and keypad on putty.

3.2.3 Chipset

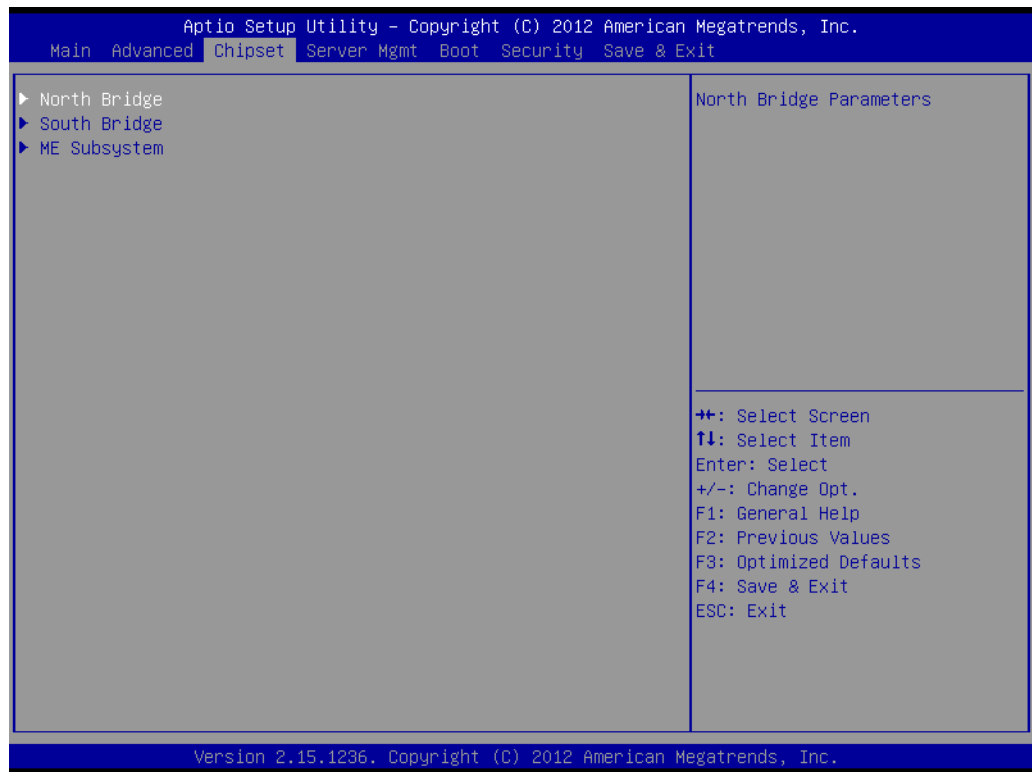

3.2.3.1 North Bridge

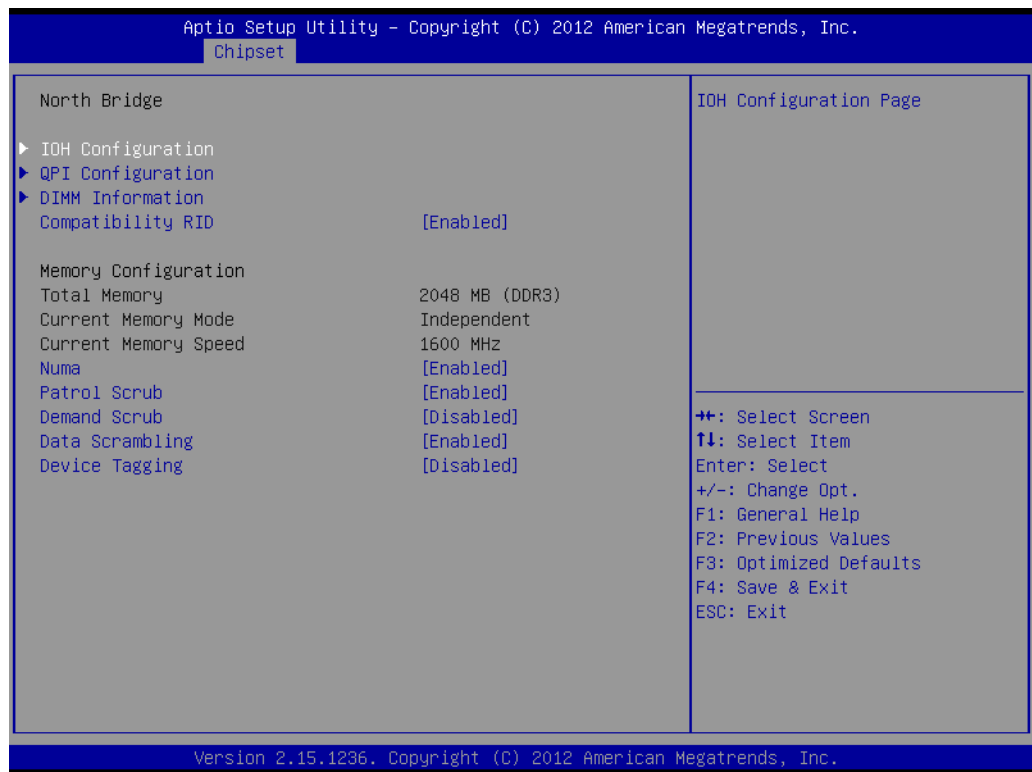

- **Compatibility RID**
Support for Compatibility Revision ID (CRID). Functionality mentioned in BIOS spec.
- **Numa**
Enable/Disable non uniform memory access (NUMA).
- **Patrol Scrub**
Enable/Disable patrol scrub feature.
- **Demand Scrub**
Enable/Disable demand scrub feature.
- **Data Scrambling**
Enable/Disable data scrambling.
- **Device Tagging**
Enable/Disable device tagging.

- **IOH Configuration**

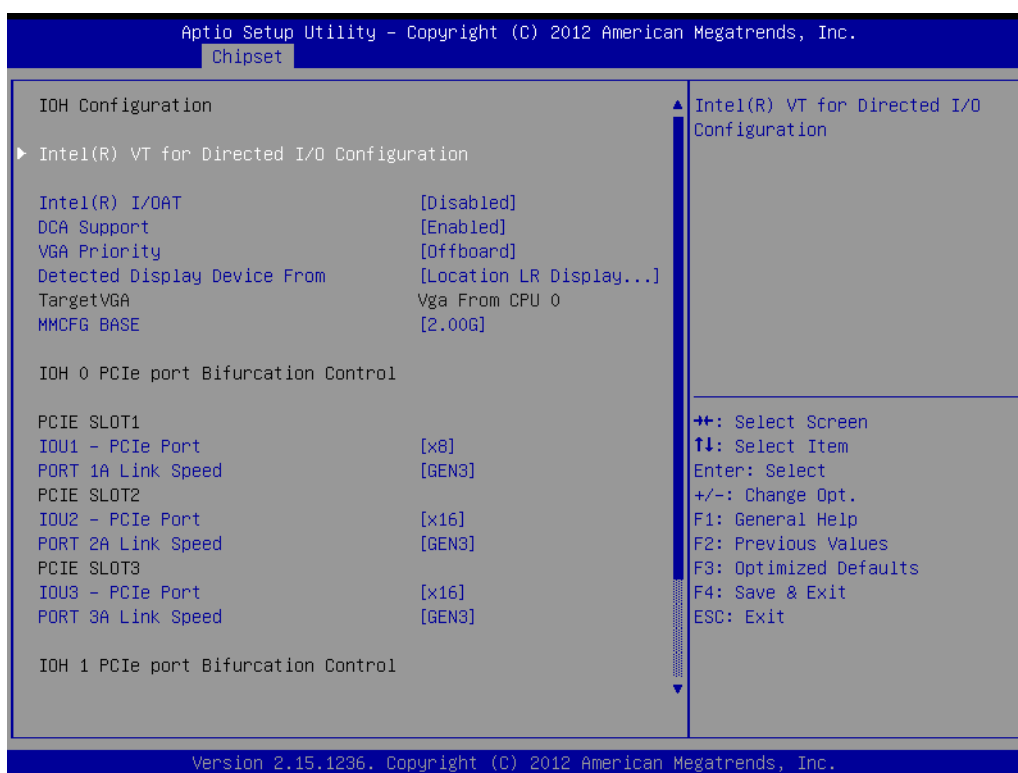

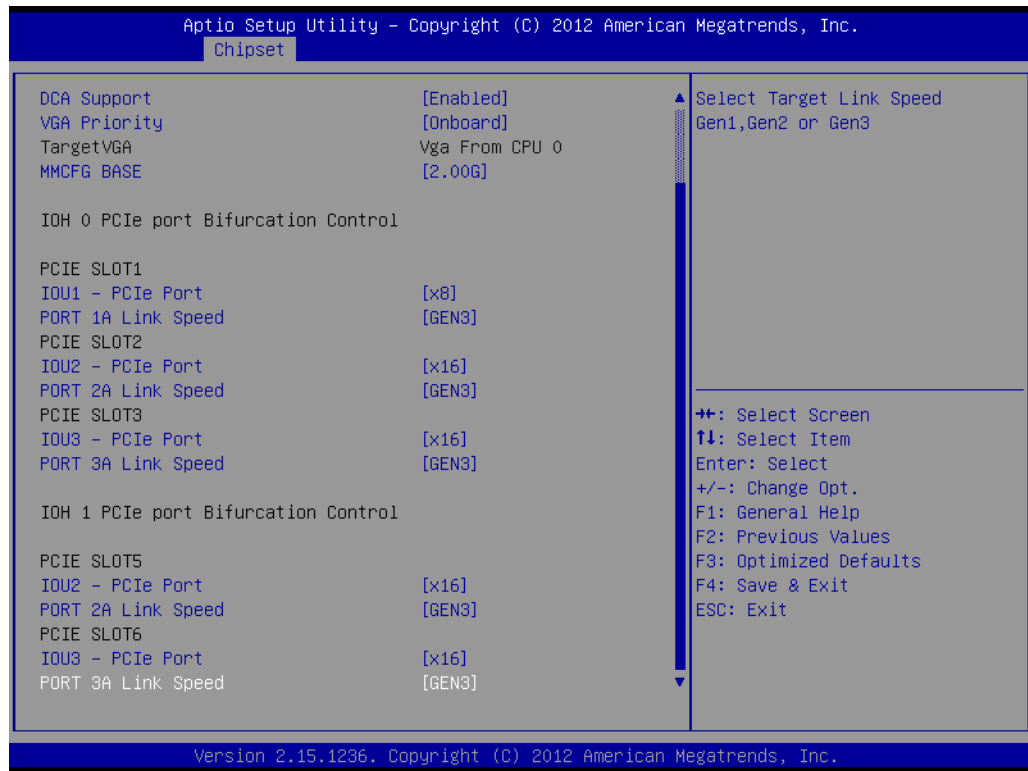

- **Intel I/OAT**
Enable/Disable Intel I/O Acceleration Technology function.
- **DCA Support**
Enable/Disable Direct Cache Access Support
- **VGA Priority**
Determines priority between onboard and 1st off-board video device found.
- **MMCFG Base**
Memory reservation for PCI/PCI-X/PCI-E device of 32-bit operating system.
- **IOH0 PCIe port bifurcation control**
 - PCIE SLOT1**
 - IOU 1- PCIe Port**
Functions visible based on this setting:
 - x4x4
 - x8
 - PORT 1A Link Speed**
Select target link speed as Gen1, Gen2, Gen3
 - PCIE SLOT2**
 - IOU2 - PCIe Port**
Functions visible based on this setting:
 - x4x4x4x4
 - x4x4x8
 - x8x4x4
 - x8x8
 - x16

PORT 2A Link Speed

Select target link speed as Gen1, Gen2, Gen3.

PCIE SLOT3**IOU3 - PCIe Port**

Functions visible based on this setting:

x4x4x4x4

x4x4x8

x8x4x4

x8x8

x16

PORT 3A Link Speed

Select Target Link Speed as Gen1, Gen2, Gen3.

– IOH1 PCIe port bifurcation control**PCIE SLOT5****IOU2 - PCIe port**

Functions visible based on this setting :

x4x4x4x4

x4x4x8

x8x4x4

x8x8

x16

PORT 2A Link Speed

Select Target Link Speed as Gen1, Gen2, Gen3.

PCIE SLOT6**IOU3 - PCIe port**

Functions visible based on this setting :

x4x4x4x4

x4x4x8

x8x4x4

x8x8

x16

PORT 3A Link Speed

Select Target Link Speed as Gen1, Gen2, Gen3.

■ **Intel® VT for Directed I/O Configuration**

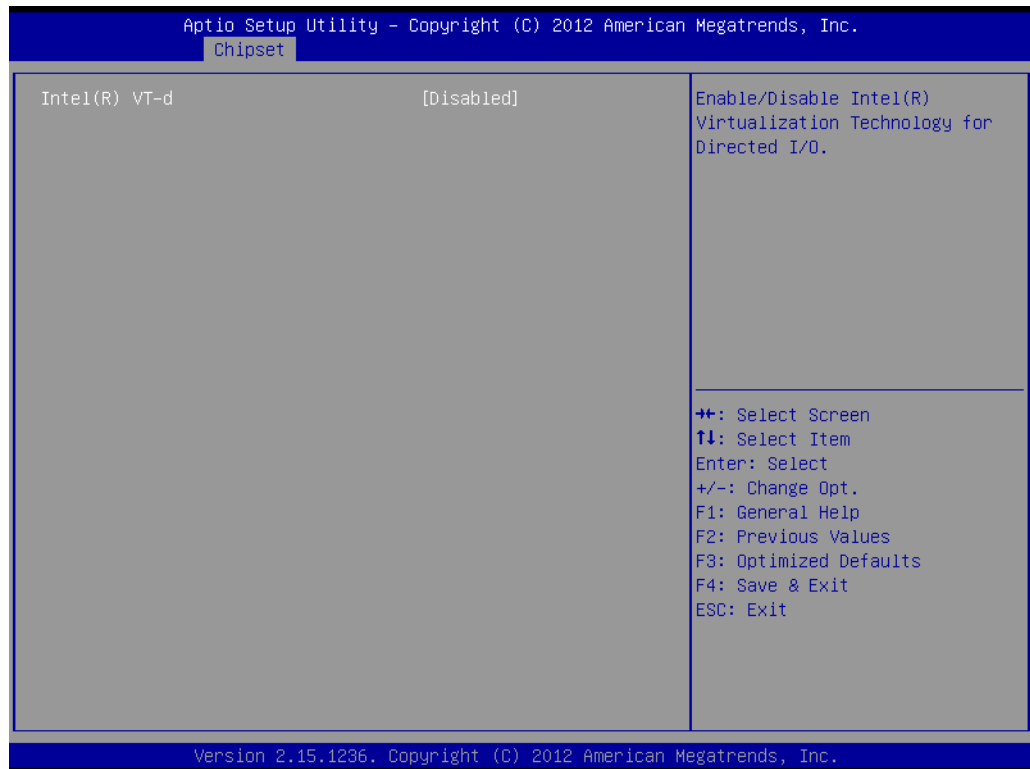

- **Intel VT-d**
Enable/Disable Intel Virtualization Technology for Directed I/O.

■ **QPI Configuration**

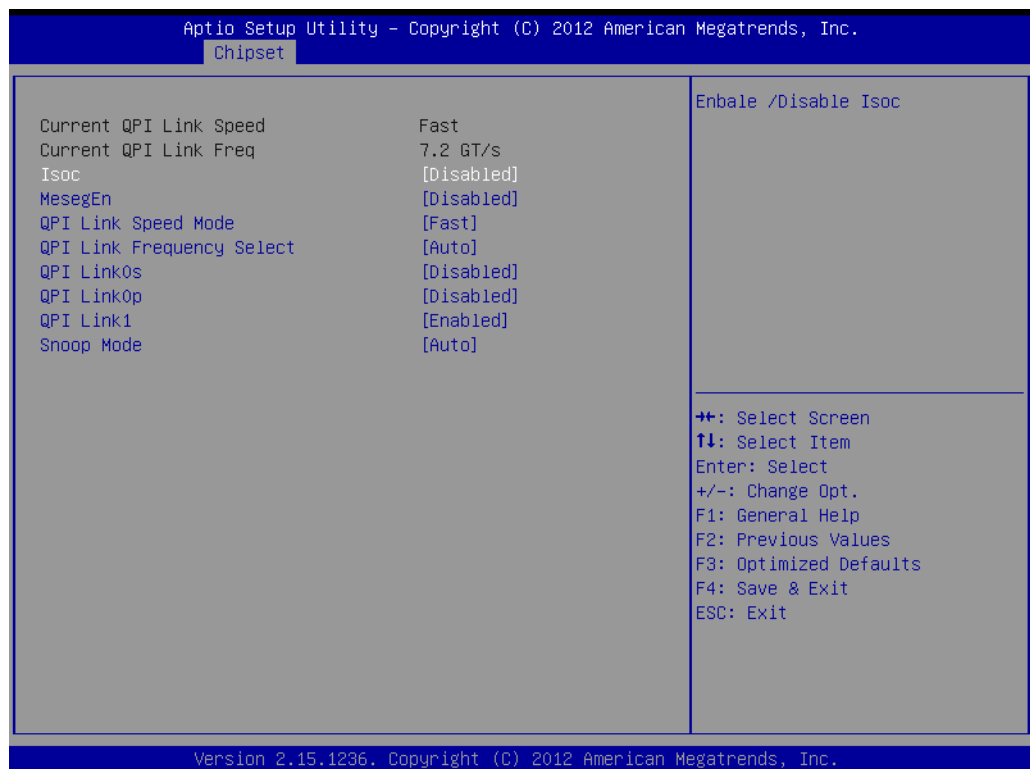

- **Isoc**
Enable/Disable Isoc
- **QPI Link Speed Mode**
Select the QPI link speed as either the Fast mode or Slow Mode.
- **QPI Link Frequency Select**
Allows for selecting the QPI Link frequency.
- **QPI Link0s**
Enable/Disable QPI Link0s
- **QPI Link0p**
Enable/Disable QPI Link0p
- **QPI Link1**
Enable/Disable QPI Link1

■ DIMM Information

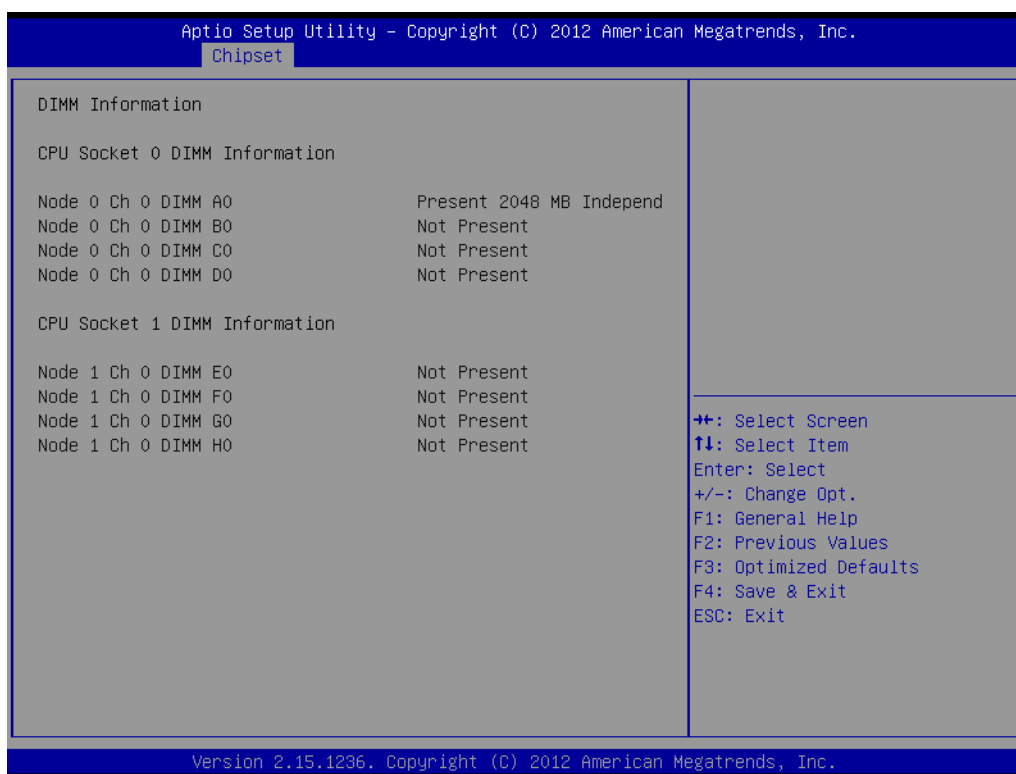

3.2.3.2 South Bridge

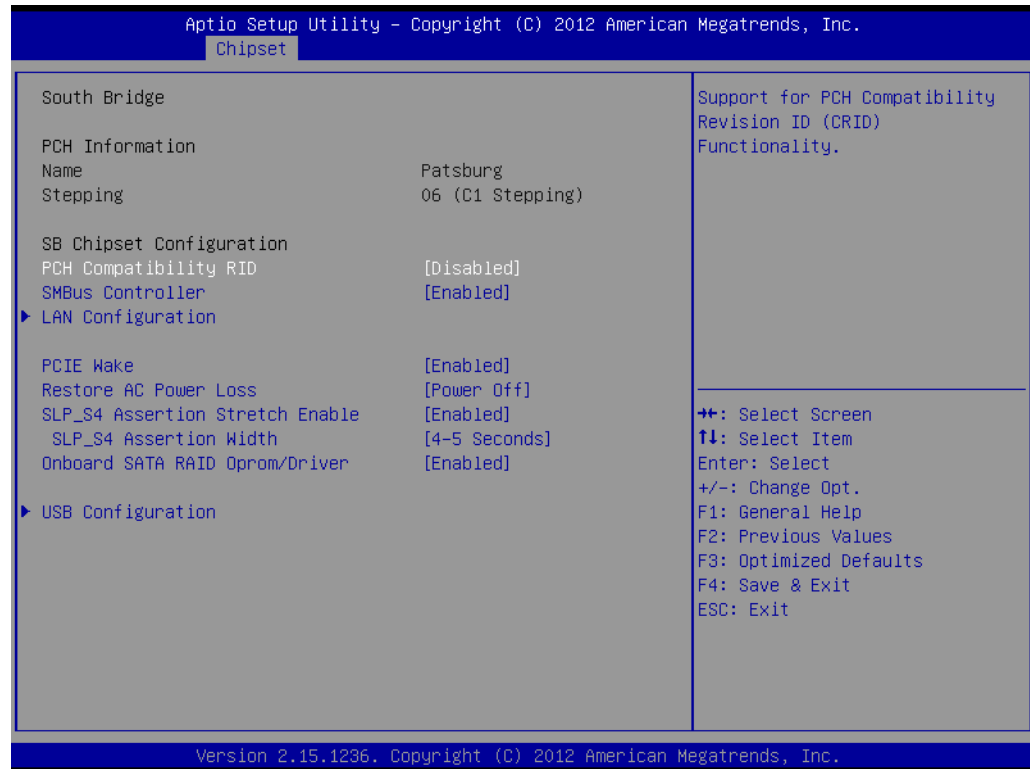

- **PCH Compatibility RID**
Enable/Disable PCH Compatibility Revision ID (CRID) Functionality.
- **SMBus Controller**
Enable/Disable SMBus controller.
- **PCIE Wake**
Enable or disable PCIE to wake the system from S5.
- **Restore AC Power Loss**
Specify what state to go to when power is re-applied after a power failure (G3 state).
- **SLP_S4 Assertion Stretch Enable**
Enable/Disable SLP_S4 Assertion Stretch function.
- **Onboard SATA RAID OproM**
Enable/Disable onboard SATA RAID option rom if Launch Storage OproM is enabled.

■ LAN Configuration

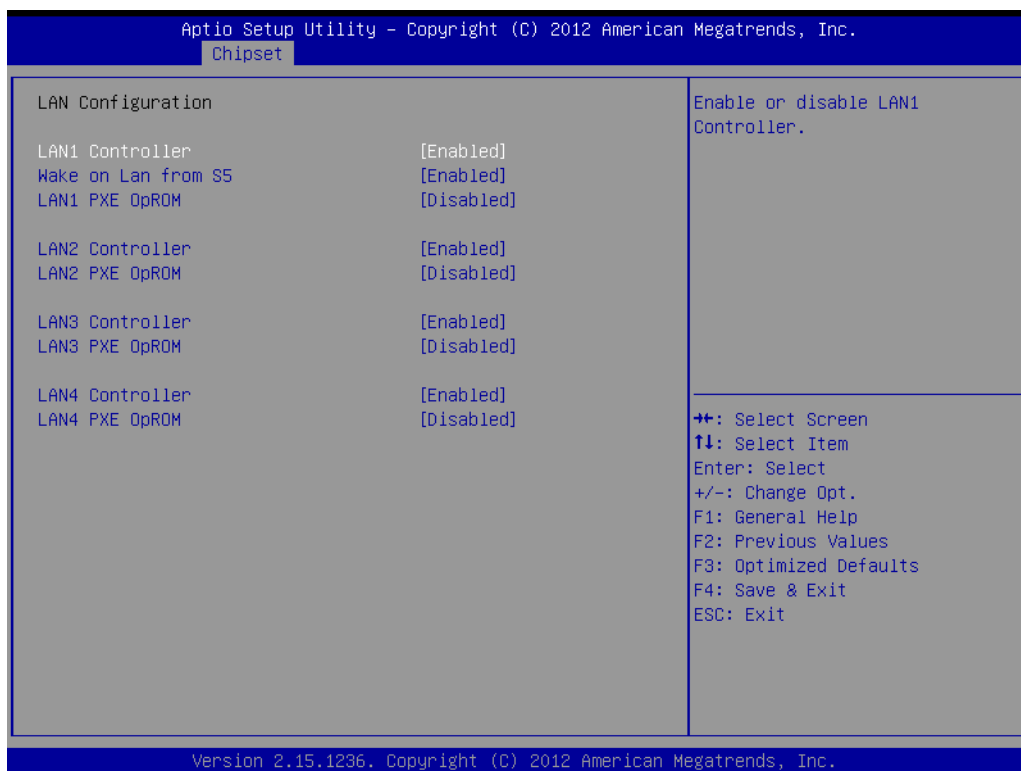

- **LAN1 Controller**
Enable/Disable Intel 82579LM Controller support.
- **Wake on LAN From S5**
Enable/Disable Intel 82579LM controller wake up from S5 support.
- **LAN1 PXE Oprom**
Enable/Disable Boot option for Intel 82579LM controller.
- **LAN2 Controller**
Enable/Disable Intel I210AT Controller support.
- **LAN2 PXE Oprom**
Enable/Disable Boot option for Intel I210AT controller.
- **LAN3 Controller**
Enable/Disable Intel I210AT Controller support.
- **LAN3 PXE Oprom**
Enable/Disable Boot option for Intel I210AT controller.
- **LAN4 Controller**
Enable/Disable Intel I210AT Controller support.
- **LAN4 PXE Oprom**
Enable/Disable Boot option for Intel I210AT controller.

■ USB Configuration

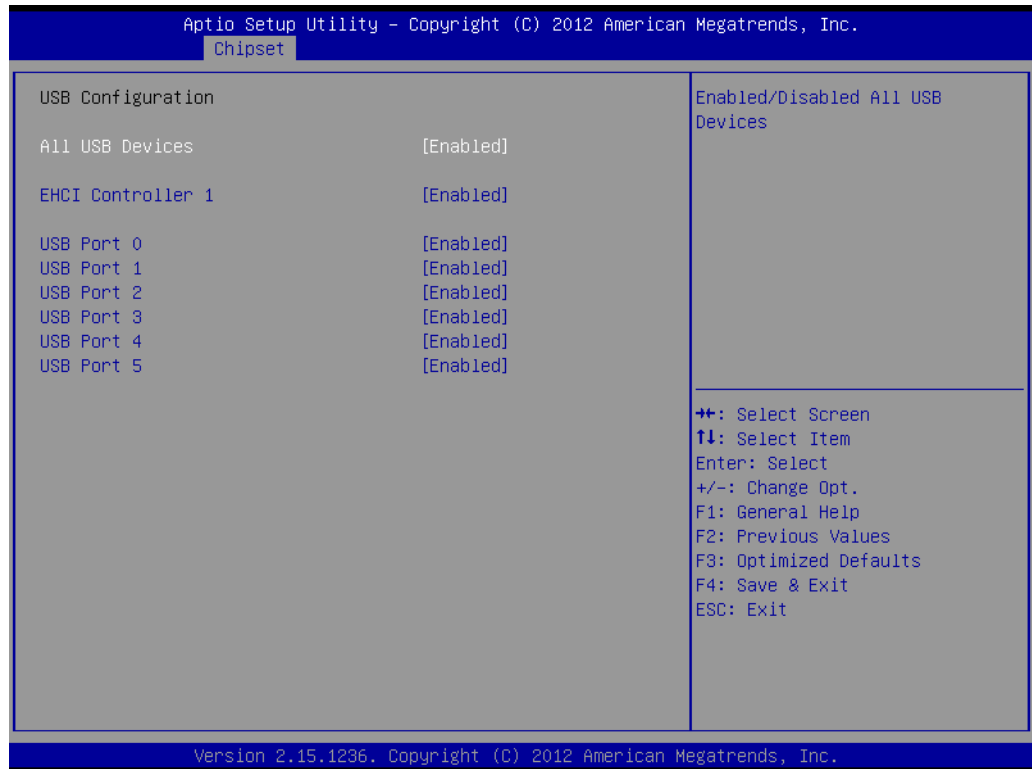

- **All USB Devices**
Enable/Disable all USB devices.
- **EHCI Controller 1**
Enable/Disable USB 2.0 (EHCI) support.
- **USB Port 0 ~ 5**
Enable/Disable USB 2.0 port 0 ~ 5.

3.2.3.3 ME Subsystem

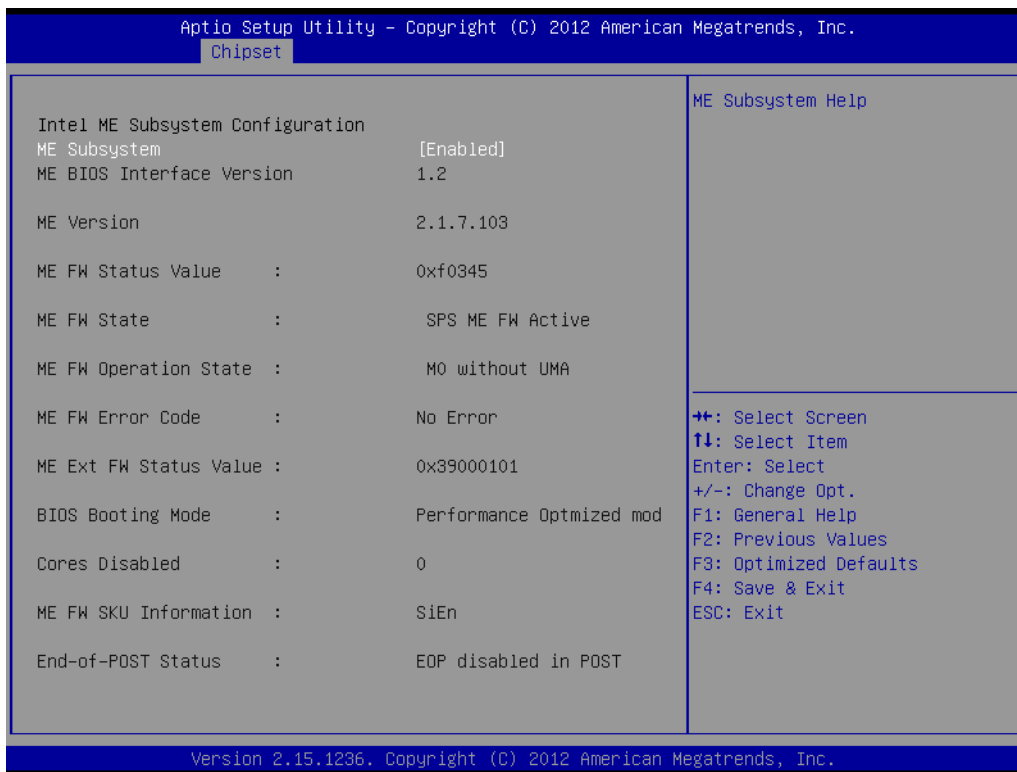

3.2.4 Server Management

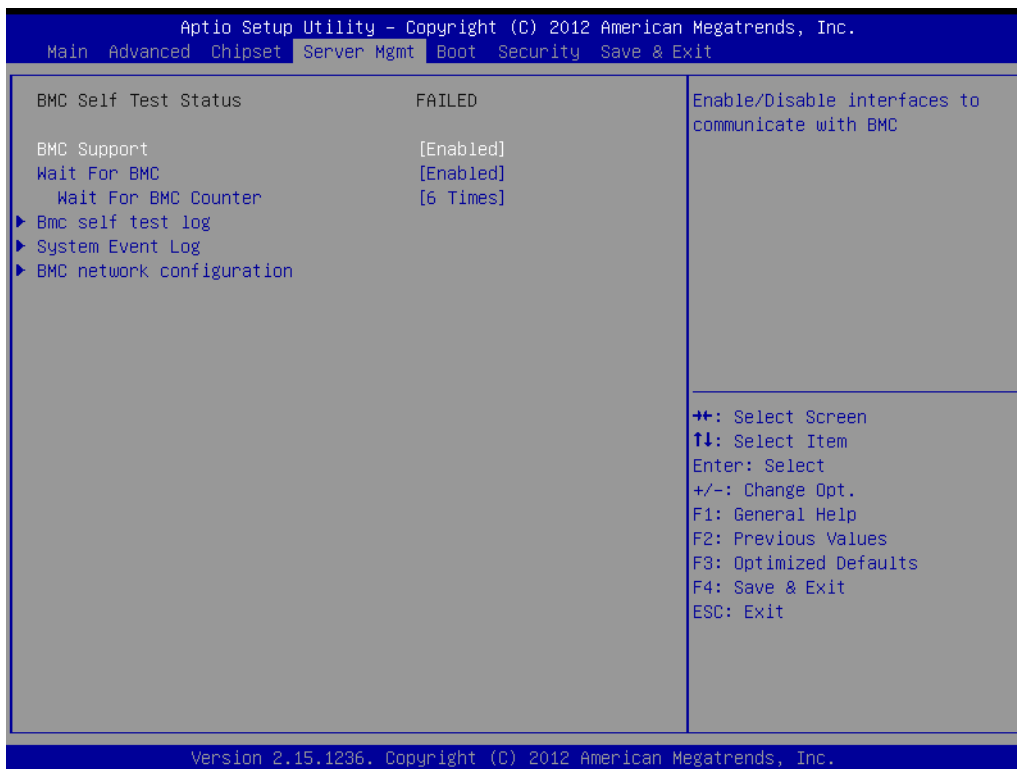

- **BMC Support**
Enable/Disable interfaces to communicate with BMC
- **Wait for BMC**
If enabled, motherboard will wait 30 ~ 60 seconds until BMC module boots up completely. After that, the normal BIOS post screen will be displayed.
If disabled, motherboard will not wait for BMC module's response.
- **Wait for BMC counter**
Wait for BMC counter for initialize host to BMC interfaces.
The MB beep per 5 seconds to check it.
- **BMC Self Test Log**



- **Erase Log**
Erase log options.
- **When Log is Full**
Select the action to be taken when log is full.

■ System Event Log

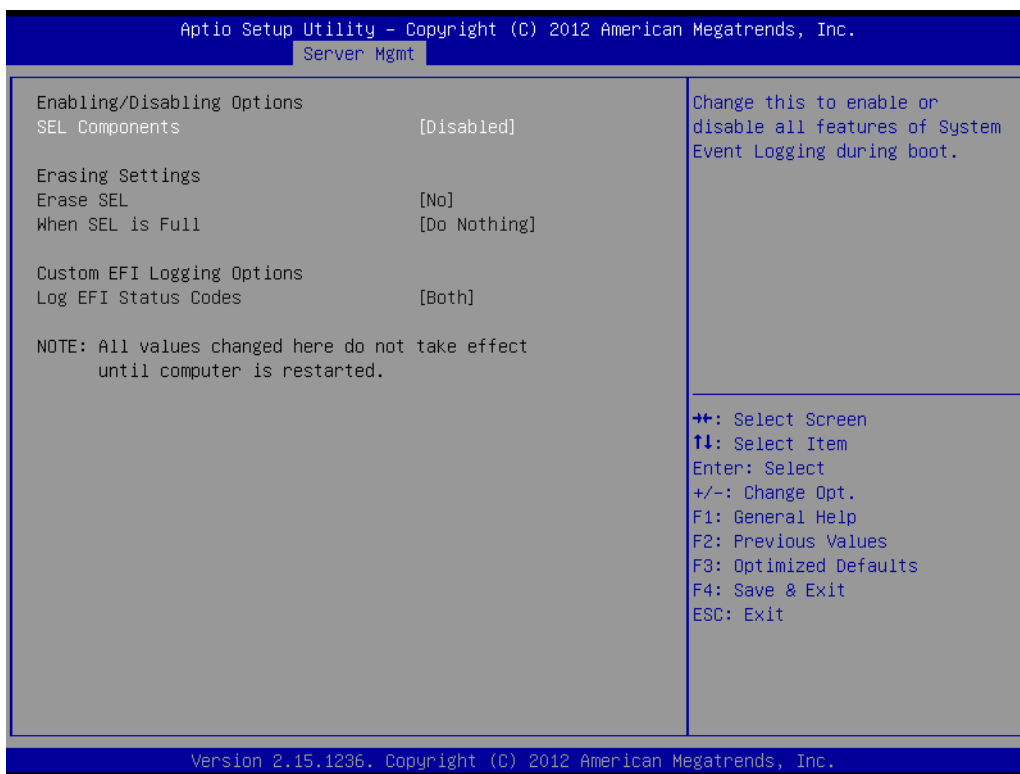

- **SEL Components**
Enable/Disable all features of system event logging during boot.
- **Erase SEL**
Choose options for erasing SEL.
- **When SEL is Full**
Choose options for reactions to a full SEL.
- **Log EFI Status Codes**
Disable the logging of EFI status codes or log only error code or only progress code or both.

■ BMC Network Configuration



– Configuration Address Source

Select to configure LAN channel parameters statically or dynamically (by BMC). Unspecified option will not modify any BMC network parameters during BIOS phase.

3.2.5 Boot

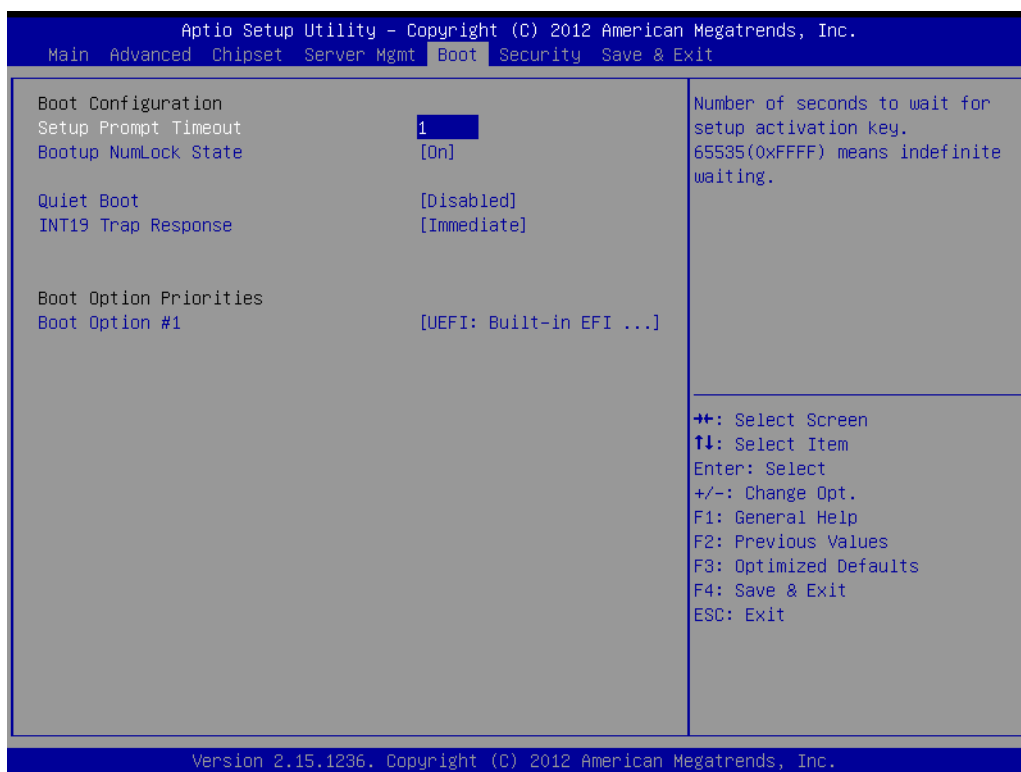

- **Setup Prompt Timeout**
Number of seconds to wait for setup activation key. 16 (0x10) means indefinite waiting.
- **Bootup NumLock State**
Select the keyboard NumLock state.
- **Quiet Boot**
Enable/Disable quiet boot option.
- **INT19 Trap Response**
BIOS reaction on INT19 trapping by option ROM:
Immediate - execute the trap right away.
Postponed - execute the trap during legacy boot.
- **Boot Option**
Sets the system boot priorities.

3.2.6 Security

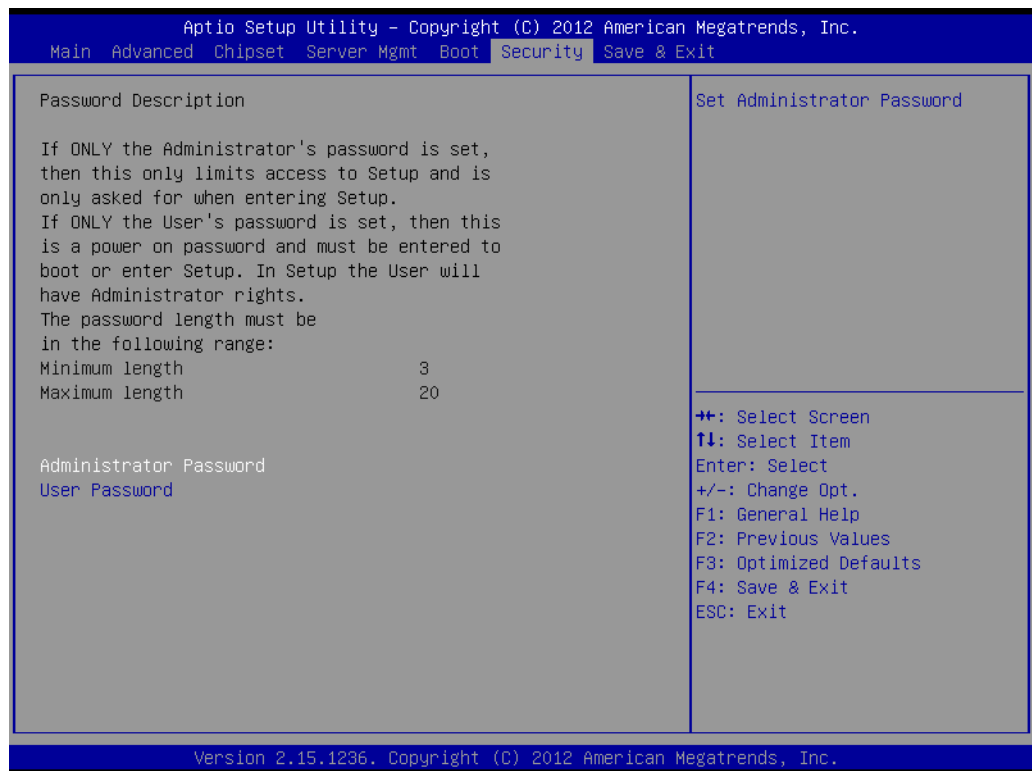

3.2.7 Save & Exit

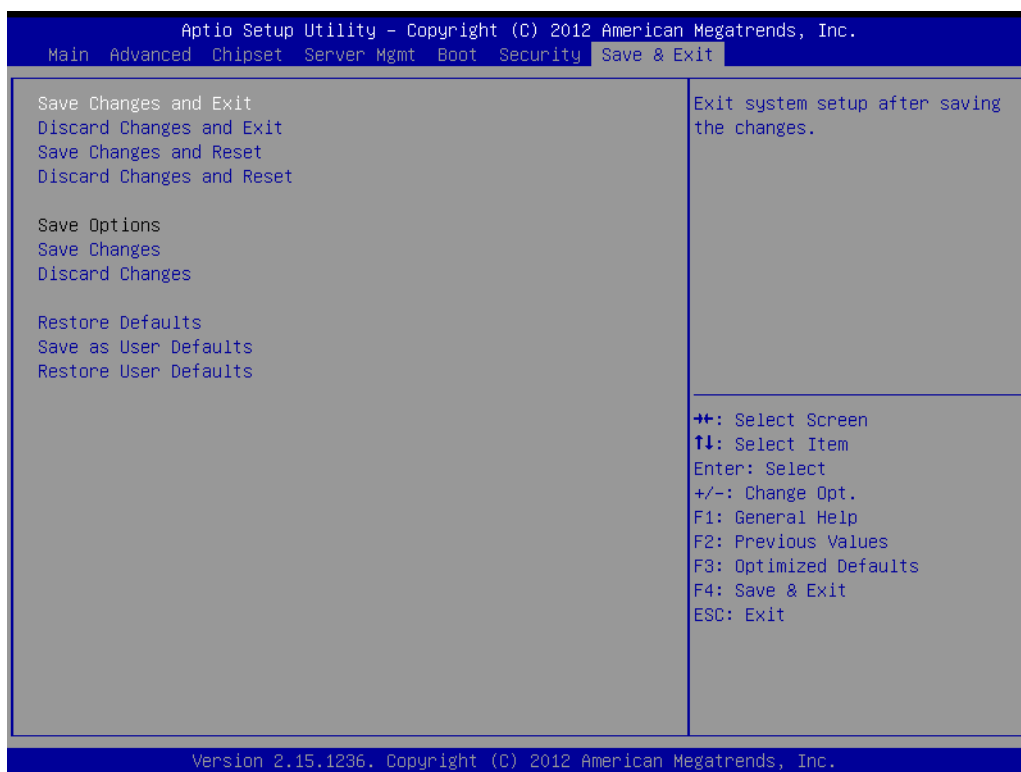

- **Save Changes and Exit**
Exit system setup after saving the changes.
- **Discard Changes and Exit**
Exit system setup without saving any changes.
- **Save Changes and Reset**
Reset the system after saving changes.
- **Discard Changes and Reset**
Reset system setup without saving any changes.
- **Save Changes**
Save changes done so far to any of the setup options.
- **Discard Changes**
Discard changes done so far to any of the setup options.
- **Restore Defaults**
Restore/Load default values for all the setup options.
- **Save as User Defaults**
Save the changes done so far as user defaults.
- **Restore User Defaults**
Restore the user defaults to all the setup options.

Chapter 4

Chipset Software
Installation Utility

4.1 Before You Begin

To facilitate the installation of the enhanced display drivers and utility software, read the instructions in this chapter carefully. The drivers for the AGS-910 are located on the software installation CD.

Before beginning, it is important to note that most display drivers need to have the relevant software application already installed on the system prior to installing the enhanced display drivers. In addition, many of the installation procedures assume that you are familiar with both the relevant software applications and operating system commands. Review the relevant operating system commands and the pertinent sections of your application software's user manual before performing the installation.

4.2 Introduction

4.2.1 Main Menu

The Intel Chipset Software Installation (CSI) utility installs the Windows INF files that outline to the operating system how the chipset components will be configured. This is needed for the proper functioning of the following features:

- Core PCI PnP services
- Serial ATA interface support
- USB 1.1/2.0 support
- Identification of Intel chipset components in the Device Manager

Note! *The files on the software installation CD are compressed. Do not attempt to install the drivers by copying the files manually. You must use the supplied SETUP program to install the drivers.*



Note! *The chipset driver is used for the following versions of Windows, and it has to be installed before installing all the other drivers:*



<i>Windows Server 2012 R2 Standard</i>	<i>x64</i>
<i>Windows Server 2012 Standard</i>	<i>x64</i>
<i>Windows Server 2008 Enterprise Edition R2(SP1)</i>	<i>x64</i>
<i>Windows 8 Professional</i>	<i>x86 & x64</i>
<i>Windows 7(Ultimate SP1)</i>	<i>x86 & x64</i>

4.3 Windows OS Driver Setup

1. Insert the driver CD into your system's CD-ROM drive. When the folder is displayed, move the mouse cursor over the folder "01_Intel INF". Find the executable in this folder, click to install the driver.

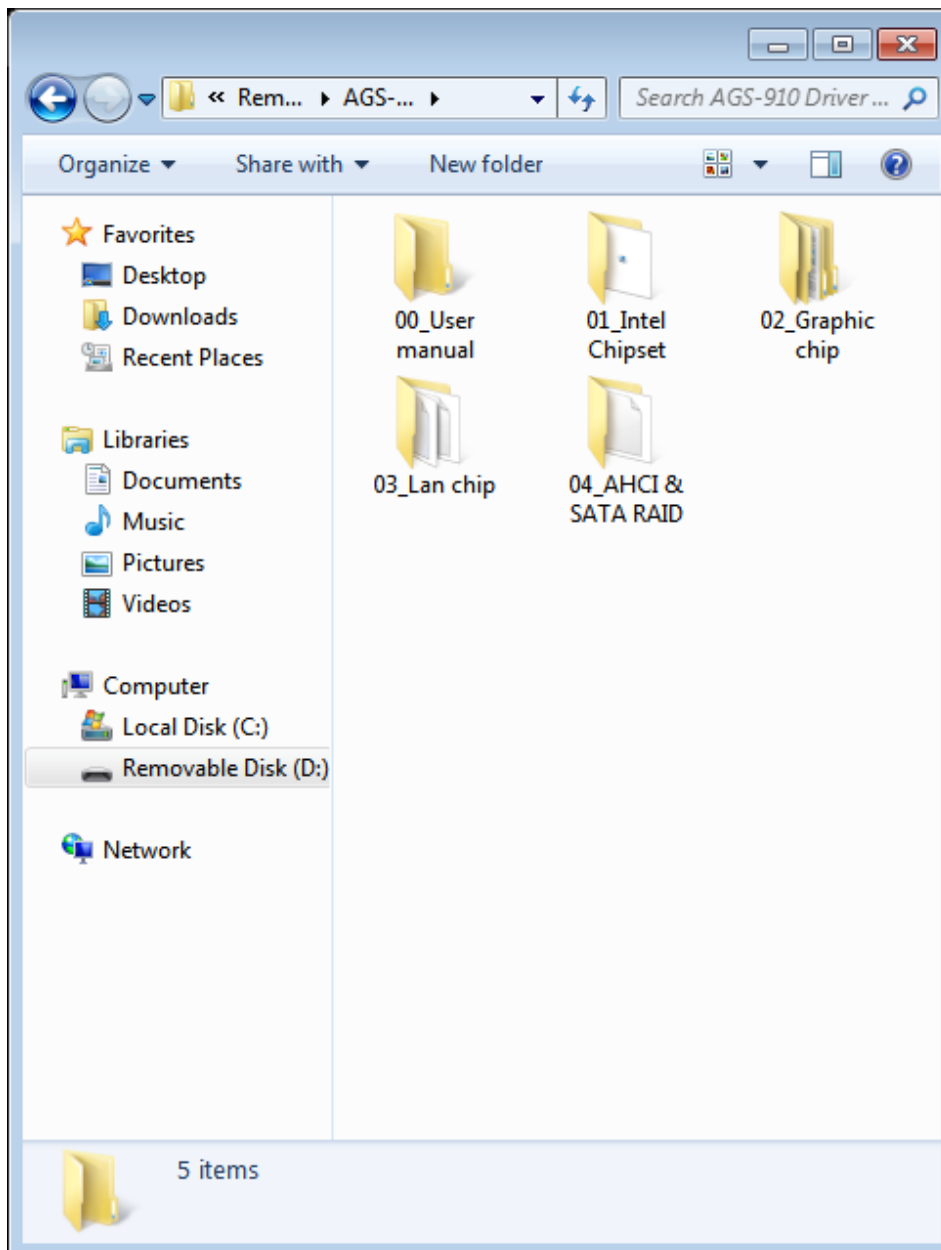

2. Click setup to execute program.

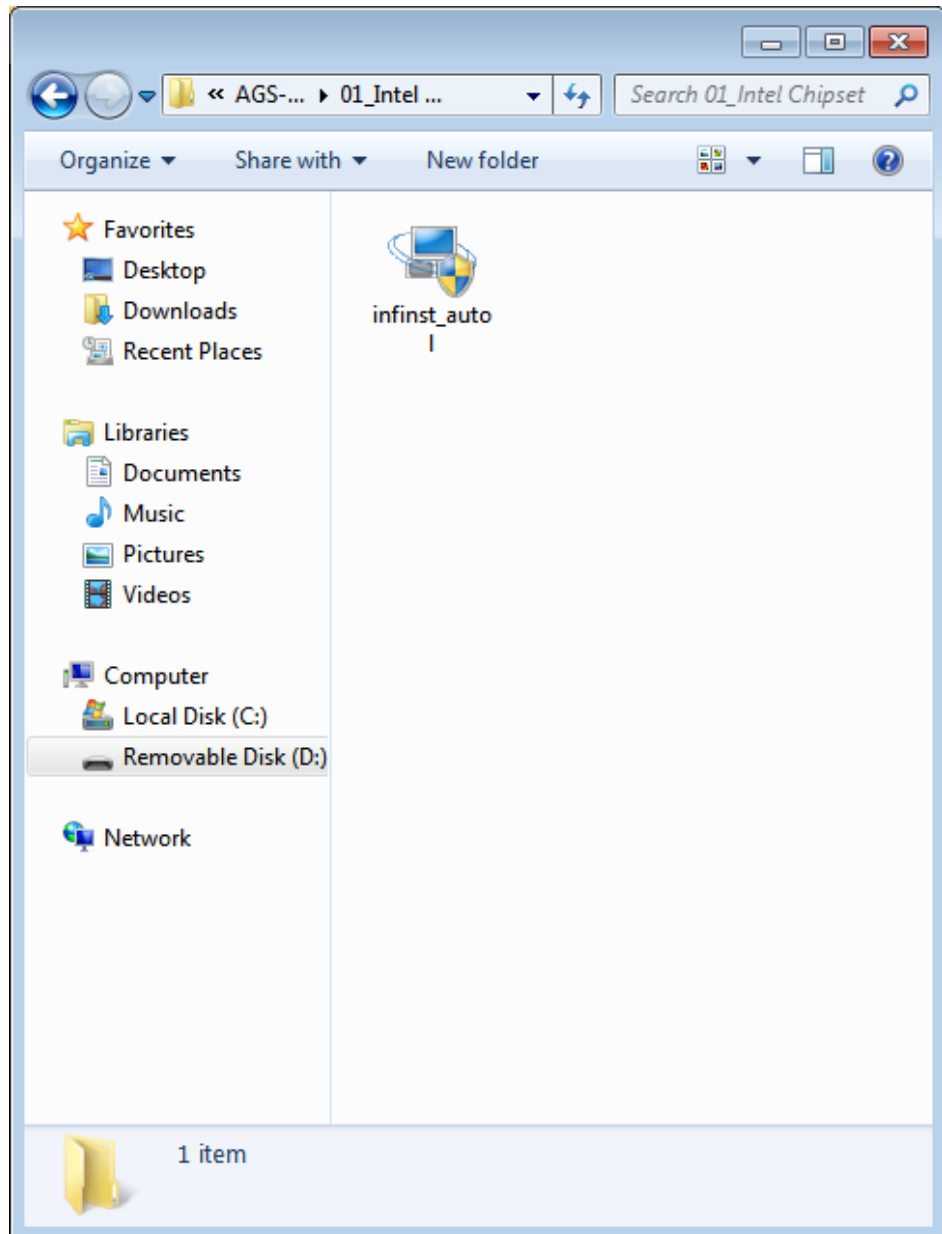

Chapter 5

VGA Setup

5.1 Introduction

Install the ASPEED VGA driver to enable this function, which includes the following features:

- 32-bit 2D graphics engine on board for normal use.
- 64 MB RAM for this chip, the highest resolution is 1920x1200.

5.2 Windows Series Driver Setup

Insert the driver CD into your system's CD-ROM drive. When the folder is displayed, navigate to the "02_Graphic chip" folder and click the executable file to complete the installation of the drivers for OS that you need.

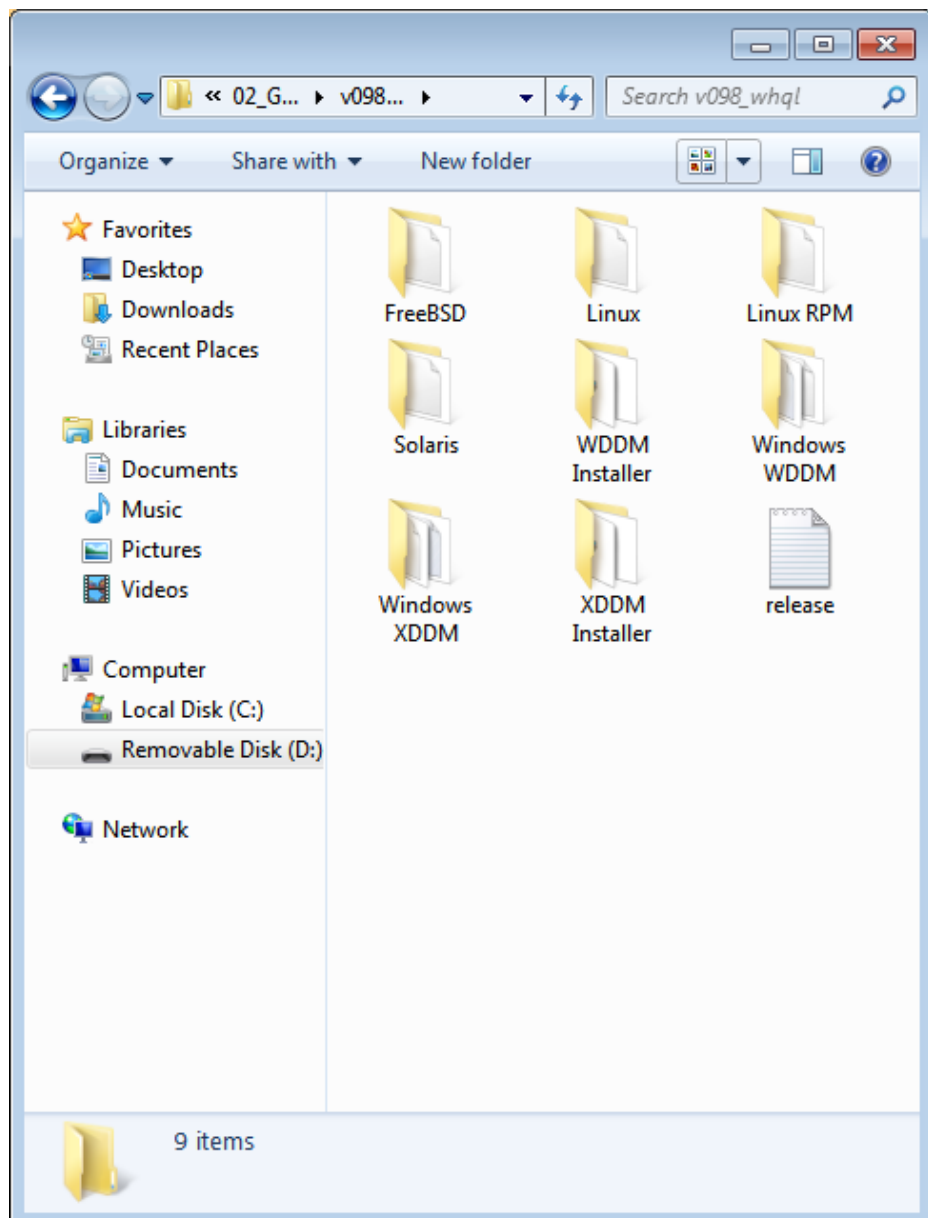

- Note!**
1. If AGS-910 carries an additional graphics card for VGA output, please set this additional graphic card as "major output" under the "Display properties" of OS.
 2. Please use the driver file from "Windows WDDM" folder as first choice.

Chapter 6

LAN Configuration &
SATA RAID & AHCI
Setup

6.1 LAN Configuration

6.1.1 Introduction

The AGS-910 has four Gigabit Ethernet LAN connections via dedicated PCI Express x1 lanes: GbE LAN1 - Intel 82579LM; GbE LAN2 ~ LAN4 Intel I210AT.

They offer bandwidth of up to 500 MB/sec, eliminating the bottleneck of network data flow and incorporating Gigabit Ethernet at 1000 Mbps.

6.1.2 Features

- 10/100/1000Base-T Ethernet controller
- 10/100/1000Base-T triple-speed MAC
- Full duplex at 10, 100, or 1000 Mbps and half duplex at 10 or 100 Mbps
- Wake-on-LAN (WOL) support
- PCIe x1 host interface

6.1.3 Installation

The integrated Intel gigabit Ethernet controller supports all major network operating systems. However, the installation procedure varies with different operating systems. In the following sections, refer to the one that provides the driver setup procedure for the operating system you are using.

6.1.4 Windows Series Driver Setup (LAN)

1. Insert the driver CD into your system's CD-ROM drive. Select folder "03_Lan chip" then click the proper Lan driver for the OS.

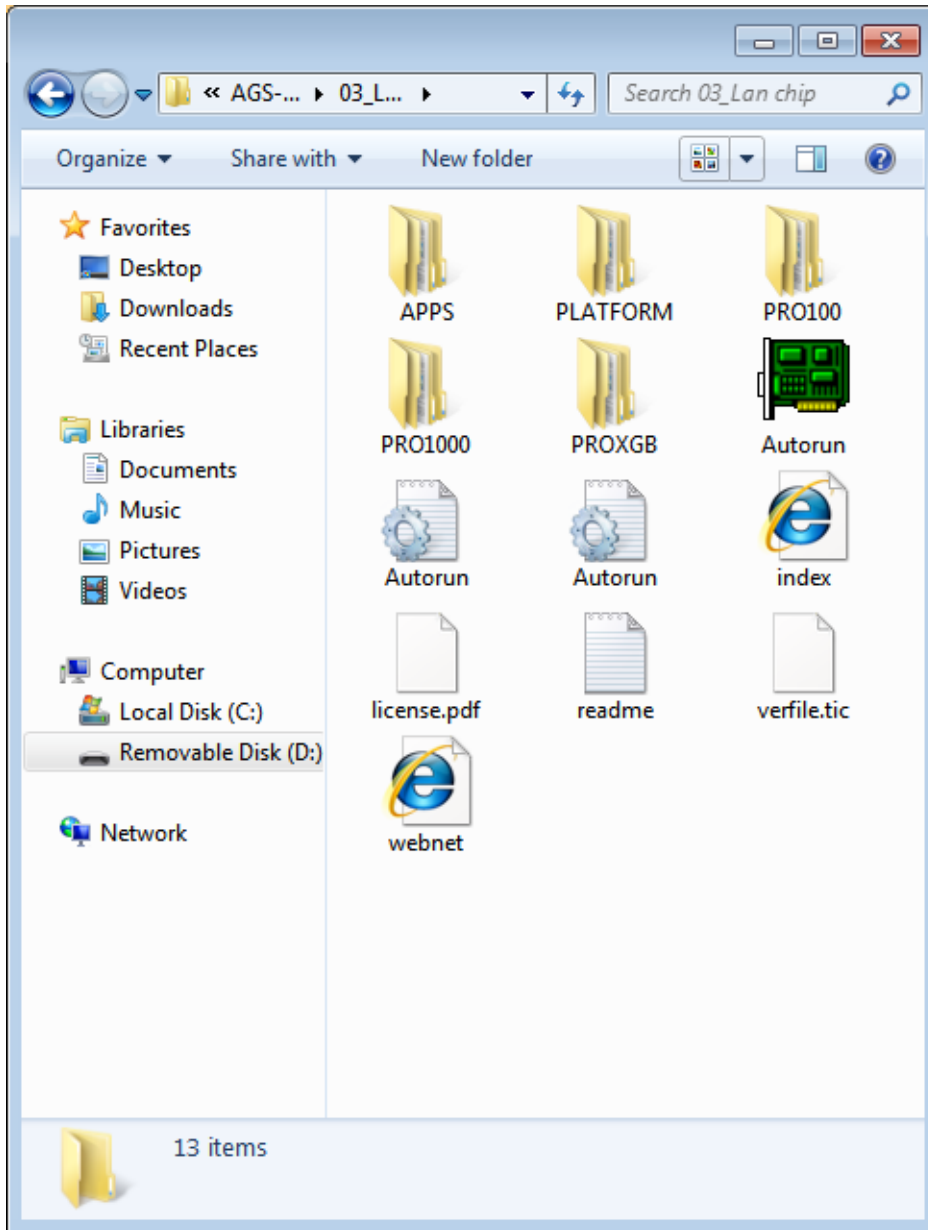

6.2 AHCI & SATA RAID

Intel C602J PCH chip offers SATA RAID with RAID 0, 1, 10, 5 under Windows operating system.

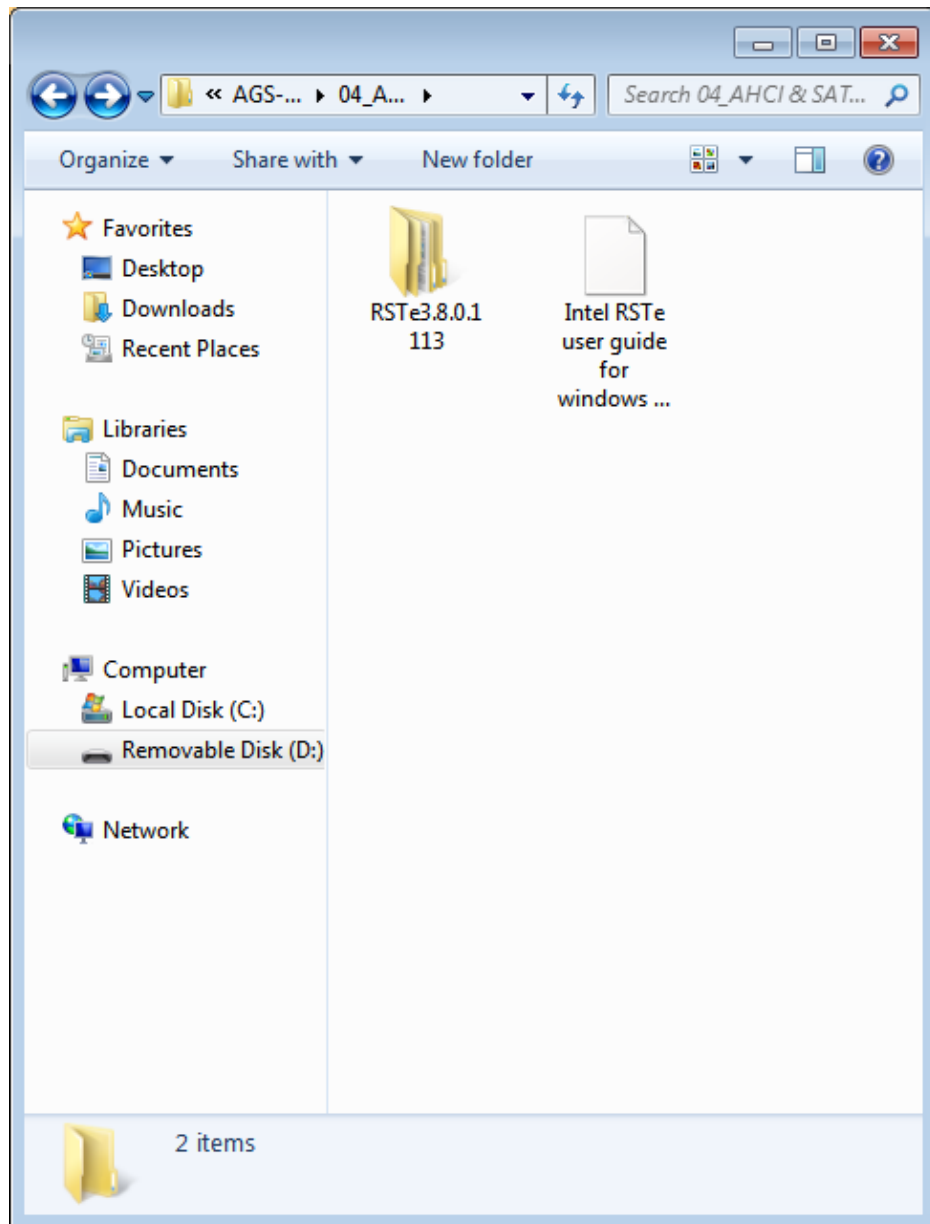

Appendix **A**

Programming the
Watchdog Timer

The ASMB-910's watchdog timer can be used to monitor system software operation and take corrective action if the software fails to function within the programmed period. This section describes the operation of the watchdog timer and how to program it.

A.1 Watchdog Timer Overview

The watchdog timer is built in to the hardware monitor NCT7904D. It provides the following functions for user programming:

- Can be enabled and disabled by user program
- Timer can be set from 1 to 255 seconds or 1 to 255 minutes
- Generates an interrupt or resets signal if the software fails to reset the timer before time-out

A.2 Programming the Watchdog Timer

The Watch Dog timer programming steps as below:

1. Set Bank0 CR[E1h] Bit0 to 1 to enable Soft Watch Dog.
2. Set Bank0 CR[E3h] Timeout timer for Soft Watch Dog.
3. Set Bank0 CR[E0h] to 55h to enable Soft Watch Dog Timer. Set to AAh will disable Soft Watch Dog Timer.
4. The Soft Watch Dog will start count down.
5. When the timer that we set to CR[E3h] is timeout , WDTRST# will issue low pulse signal.
6. The Bank0 CR[E2h] is Watch Dog Status Register for reading.

ADVANTECH

Enabling an Intelligent Planet

www.advantech.com

Please verify specifications before quoting. This guide is intended for reference purposes only.

All product specifications are subject to change without notice.

No part of this publication may be reproduced in any form or by any means, electronic, photocopying, recording or otherwise, without prior written permission of the publisher.

All brand and product names are trademarks or registered trademarks of their respective companies.

© Advantech Co., Ltd. 2014