



Is Now Part of



ON Semiconductor®

To learn more about ON Semiconductor, please visit our website at
www.onsemi.com

Please note: As part of the Fairchild Semiconductor integration, some of the Fairchild orderable part numbers will need to change in order to meet ON Semiconductor's system requirements. Since the ON Semiconductor product management systems do not have the ability to manage part nomenclature that utilizes an underscore (_), the underscore (_) in the Fairchild part numbers will be changed to a dash (-). This document may contain device numbers with an underscore (_). Please check the ON Semiconductor website to verify the updated device numbers. The most current and up-to-date ordering information can be found at www.onsemi.com. Please email any questions regarding the system integration to Fairchild_questions@onsemi.com.

ON Semiconductor and the ON Semiconductor logo are trademarks of Semiconductor Components Industries, LLC dba ON Semiconductor or its subsidiaries in the United States and/or other countries. ON Semiconductor owns the rights to a number of patents, trademarks, copyrights, trade secrets, and other intellectual property. A listing of ON Semiconductor's product/patent coverage may be accessed at www.onsemi.com/site/pdf/Patent-Marking.pdf. ON Semiconductor reserves the right to make changes without further notice to any products herein. ON Semiconductor makes no warranty, representation or guarantee regarding the suitability of its products for any particular purpose, nor does ON Semiconductor assume any liability arising out of the application or use of any product or circuit, and specifically disclaims any and all liability, including without limitation special, consequential or incidental damages. Buyer is responsible for its products and applications using ON Semiconductor products, including compliance with all laws, regulations and safety requirements or standards, regardless of any support or applications information provided by ON Semiconductor. "Typical" parameters which may be provided in ON Semiconductor data sheets and/or specifications can and do vary in different applications and actual performance may vary over time. All operating parameters, including "Typicals" must be validated for each customer application by customer's technical experts. ON Semiconductor does not convey any license under its patent rights nor the rights of others. ON Semiconductor products are not designed, intended, or authorized for use as a critical component in life support systems or any FDA Class 3 medical devices or medical devices with a same or similar classification in a foreign jurisdiction or any devices intended for implantation in the human body. Should Buyer purchase or use ON Semiconductor products for any such unintended or unauthorized application, Buyer shall indemnify and hold ON Semiconductor and its officers, employees, subsidiaries, affiliates, and distributors harmless against all claims, costs, damages, and expenses, and reasonable attorney fees arising out of, directly or indirectly, any claim of personal injury or death associated with such unintended or unauthorized use, even if such claim alleges that ON Semiconductor was negligent regarding the design or manufacture of the part. ON Semiconductor is an Equal Opportunity/Affirmative Action Employer. This literature is subject to all applicable copyright laws and is not for resale in any manner.



July 2014



KSC5502D / KSC5502DT NPN Triple Diffused Planar Silicon Transistor

Features

- High Voltage Power Switch Switching Application
- Wide Safe Operating Area
- Built-in Free-Wheeling Diode
- Suitable for Electronic Ballast Application
- Small Variance in Storage Time
- Two Package Choices : D-PAK or TO-220

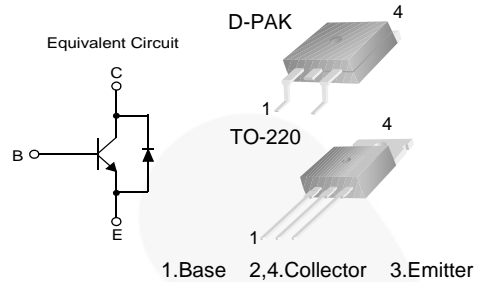

Ordering Information

Part Number	Top Mark	Package	Packing Method
KSC5502DTM	C5502D	TO-252 3L (DPAK)	Tape and Reel
KSC5502DTTU	C5502D	TO-220 3L	Rail

Absolute Maximum Ratings

Stresses exceeding the absolute maximum ratings may damage the device. The device may not function or be operable above the recommended operating conditions and stressing the parts to these levels is not recommended. In addition, extended exposure to stresses above the recommended operating conditions may affect device reliability. The absolute maximum ratings are stress ratings only. Values are at $T_C = 25^\circ\text{C}$ unless otherwise noted.

Symbol	Parameter	Value	Unit
V_{CBO}	Collector-Base Voltage	1200	V
V_{CEO}	Collector-Emitter Voltage	600	V
V_{EBO}	Emitter-Base Voltage	12	V
I_C	Collector Current (DC)	2	A
I_{CP}	Collector Current (Pulse) ⁽¹⁾	4	A
I_B	Base Current (DC)	1	A
I_{BP}	Base Current (Pulse) ⁽¹⁾	2	A
T_J	Junction Temperature	150	$^\circ\text{C}$
T_{STG}	Storage Temperature Range	-65 to 150	$^\circ\text{C}$
EAS	Avalanche Energy ($T_J = 25^\circ\text{C}$)	2.5	mJ

Note:

1. Pulse test: Pulse width = 5 ms, duty cycle $\leq 10\%$.

KSC5502D / KSC5502DT — NPN Triple Diffused Planar Silicon Transistor

Thermal Characteristics

Values are at $T_C = 25^\circ\text{C}$ unless otherwise noted.

Symbol	Parameter	KSC5502D (D-PAK)	KSC5502DT (TO-220)	Unit
P_C	Collector Dissipation ($T_C = 25^\circ\text{C}$)	87.83	118.16	W
$R_{\theta JC}$	Thermal Resistance, Junction to Case	1.42	1.06	$^\circ\text{C}/\text{W}$
$R_{\theta JA}$	Thermal Resistance, Junction to Ambient	111.0	62.5	$^\circ\text{C}/\text{W}$
T_L	Maximum Lead Temperature for Soldering Purpose: 1/8 inch from Case for 5 seconds	270		$^\circ\text{C}$

Electrical Characteristics

Values are at $T_C = 25^\circ\text{C}$ unless otherwise noted.

Symbol	Parameter	Conditions	Min.	Typ.	Max.	Unit	
BV_{CBO}	Collector-Base Breakdown Voltage	$I_C = 1\text{ mA}, I_E = 0$	1200	1350		V	
BV_{CEO}	Collector-Emitter Breakdown Voltage	$I_C = 5\text{ mA}, I_B = 0$	600	750		V	
BV_{EBO}	Emitter-Base Breakdown Voltage	$I_E = 500\ \mu\text{A}, I_C = 0$	12.0	13.7		V	
I_{CES}	Collector Cut-off Current	$V_{CES} = 1200\text{ V}, V_{BE} = 0$	$T_C = 25^\circ\text{C}$		100	μA	
			$T_C = 125^\circ\text{C}$		500		
I_{CEO}	Collector Cut-off Current	$V_{CE} = 600\text{ V}, I_B = 0$	$T_C = 25^\circ\text{C}$		100	μA	
			$T_C = 125^\circ\text{C}$		500		
I_{EBO}	Emitter Cut-off Current	$V_{EB} = 12\text{ V}, I_C = 0$			10	μA	
h_{FE}	DC Current Gain	$V_{CE} = 1\text{ V}, I_C = 0.2\text{ A}$	$T_C = 25^\circ\text{C}$	15	28	40	
			$T_C = 125^\circ\text{C}$	8	18		
		$V_{CE} = 1\text{ V}, I_C = 1\text{ A}$	$T_C = 25^\circ\text{C}$	4.0	6.4		
			$T_C = 125^\circ\text{C}$	3.0	4.7		
$V_{CE(sat)}$	Collector-Emitter Saturation Voltage	$I_C = 0.2\text{ A}, I_B = 0.02\text{ A}$	$T_C = 25^\circ\text{C}$		0.31	0.80	V
			$T_C = 125^\circ\text{C}$		0.54	1.10	
		$I_C = 0.4\text{ A}, I_B = 0.08\text{ A}$	$T_C = 25^\circ\text{C}$		0.15	0.60	
			$T_C = 125^\circ\text{C}$		0.23	1.00	
$V_{BE(sat)}$	Base-Emitter Saturation Voltage	$I_C = 0.4\text{ A}, I_B = 0.08\text{ A}$	$T_C = 25^\circ\text{C}$		0.77	1.00	V
			$T_C = 125^\circ\text{C}$		0.60	0.90	
		$I_C = 1\text{ A}, I_B = 0.2\text{ A}$	$T_C = 25^\circ\text{C}$		0.83	1.20	
			$T_C = 125^\circ\text{C}$		0.70	1.00	
C_{ib}	Input Capacitance	$V_{EB} = 8\text{ V}, I_C = 0, f = 1\text{ MHz}$		385	500	pF	
C_{ob}	Output Capacitance	$V_{CB} = 10\text{ V}, I_E = 0, f = 1\text{ MHz}$		60	100	pF	
f_T	Current Gain Bandwidth Product	$I_C = 0.5\text{ A}, V_{CE} = 10\text{ V}$		11		MHz	
V_F	Diode Forward Voltage	$I_F = 0.2\text{ A}$	$T_C = 25^\circ\text{C}$		0.75	1.20	V
			$T_C = 125^\circ\text{C}$		0.59		
		$I_F = 0.4\text{ A}$	$T_C = 25^\circ\text{C}$		0.80	1.30	
			$T_C = 125^\circ\text{C}$		0.64		
$I_F = 1\text{ A}$	$T_C = 25^\circ\text{C}$		0.90	1.50			

Electrical Characteristics

Values are at $T_C = 25^\circ\text{C}$ unless otherwise noted.

Symbol	Parameter	Conditions	Min	Typ.	Max.	Unit	
t_{fr}	Diode Forward Recovery Time ($di/dt=10\text{ A}/\mu\text{s}$)	$I_F = 0.2\text{ A}$		650		ns	
		$I_F = 0.4\text{ A}$		740			
		$I_F = 1\text{ A}$		785			
$V_{CE(DSAT)}$	Dynamic Saturation Voltage	$I_C = 0.4\text{ A}, I_{B1} = 80\text{ mA}, V_{CC} = 300\text{ V}$	at $1\ \mu\text{s}$	7.2		V	
			at $3\ \mu\text{s}$	1.8			
		$I_C = 1\text{ A}, I_{B1} = 200\text{ mA}, V_{CC} = 300\text{ V}$	at $1\ \mu\text{s}$	18.0			
			at $3\ \mu\text{s}$	6.0			
Resistive Load Switching ($D.C < 10\%$, Pulse Width = 20 s)							
t_{ON}	Turn-On Time	$I_C = 0.4\text{ A}, I_{B1} = 80\text{ mA}, I_{B2} = 0.2\text{ A}, V_{CC} = 300\text{ V}, R_L = 750\ \Omega$	$T_C = 25^\circ\text{C}$		175	350	ns
			$T_C = 125^\circ\text{C}$		185		
t_{OFF}	Turn-Off Time	$I_C = 0.4\text{ A}, I_{B1} = 80\text{ mA}, I_{B2} = 0.2\text{ A}, V_{CC} = 300\text{ V}, R_L = 750\ \Omega$	$T_C = 25^\circ\text{C}$		2.1	3.0	μs
			$T_C = 125^\circ\text{C}$		2.6		
t_{ON}	Turn-On Time	$I_C = 1\text{ A}, I_{B1} = 160\text{ mA}, I_{B2} = 160\text{ mA}, V_{CC} = 300\text{ V}, R_L = 300\ \Omega$	$T_C = 25^\circ\text{C}$		240	450	ns
			$T_C = 125^\circ\text{C}$		310		
t_{OFF}	Turn-Off Time	$I_C = 1\text{ A}, I_{B1} = 160\text{ mA}, I_{B2} = 160\text{ mA}, V_{CC} = 300\text{ V}, R_L = 300\ \Omega$	$T_C = 25^\circ\text{C}$		3.7	5.0	μs
			$T_C = 125^\circ\text{C}$		4.5		
Inductive Load Switching ($V_{CC} = 15\text{ V}$)							
t_{STG}	Storage Time	$I_C = 0.4\text{ A}, I_{B1} = 80\text{ mA}, I_{B2} = 0.2\text{ A}, V_Z = 300\text{ V}, L_C = 200\text{ H}$	$T_C = 25^\circ\text{C}$		1.2	2.0	μs
			$T_C = 125^\circ\text{C}$		1.5		
t_F	Fall Time	$I_C = 0.4\text{ A}, I_{B1} = 80\text{ mA}, I_{B2} = 0.2\text{ A}, V_Z = 300\text{ V}, L_C = 200\text{ H}$	$T_C = 25^\circ\text{C}$		90	200	ns
			$T_C = 125^\circ\text{C}$		65		
t_C	Cross-Over Time	$I_C = 0.4\text{ A}, I_{B1} = 80\text{ mA}, I_{B2} = 0.2\text{ A}, V_Z = 300\text{ V}, L_C = 200\text{ H}$	$T_C = 25^\circ\text{C}$		185	350	ns
			$T_C = 125^\circ\text{C}$		145		
t_{STG}	Storage Time	$I_C = 0.8\text{ A}, I_{B1} = 160\text{ mA}, I_{B2} = 160\text{ mA}, V_{CC} = 300\text{ V}, L_C = 200\text{ H}$	$T_C = 25^\circ\text{C}$		3.30	4.50	μs
			$T_C = 125^\circ\text{C}$		3.75		
t_F	Fall Time	$I_C = 0.8\text{ A}, I_{B1} = 160\text{ mA}, I_{B2} = 160\text{ mA}, V_{CC} = 300\text{ V}, L_C = 200\text{ H}$	$T_C = 25^\circ\text{C}$		90	250	ns
			$T_C = 125^\circ\text{C}$		160		
t_C	Cross-over Time	$I_C = 0.8\text{ A}, I_{B1} = 160\text{ mA}, I_{B2} = 160\text{ mA}, V_{CC} = 300\text{ V}, L_C = 200\text{ H}$	$T_C = 25^\circ\text{C}$		300	600	ns
			$T_C = 125^\circ\text{C}$		570		

Typical Performance Characteristics

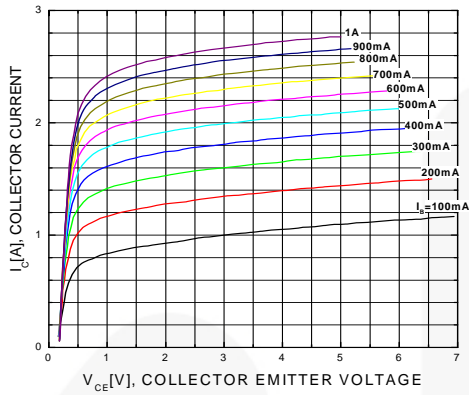

Figure 1. Static Characteristic

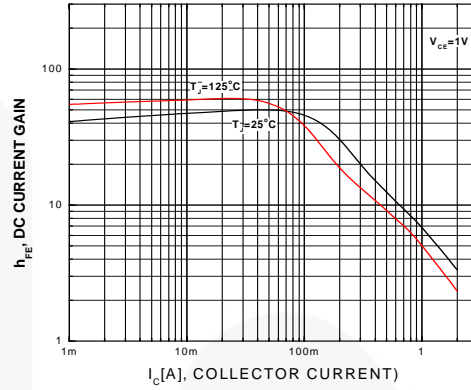

Figure 2. DC Current Gain

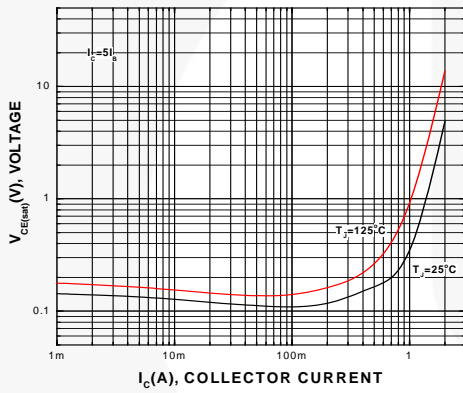

Figure 3. Collector-Emitter Saturation Voltage

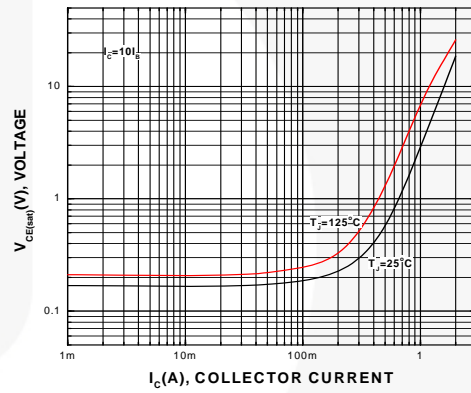

Figure 4. Collector-Emitter Saturation Voltage

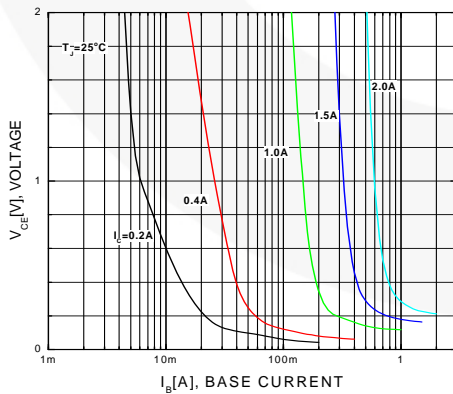

Figure 5. Typical Collector Saturation Voltage

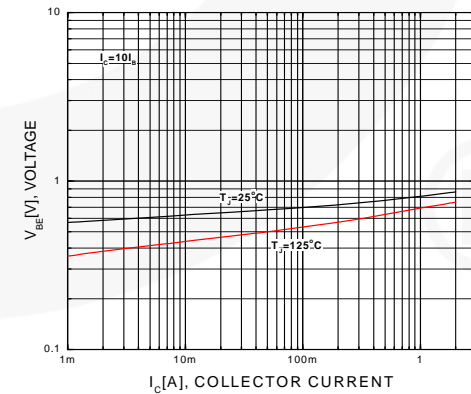

Figure 6. Base-Emitter Saturation Voltage

Typical Performance Characteristics (Continued)

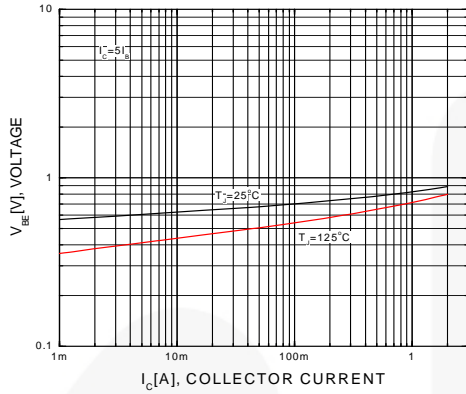

Figure 7. Base-Emitter Saturation Voltage

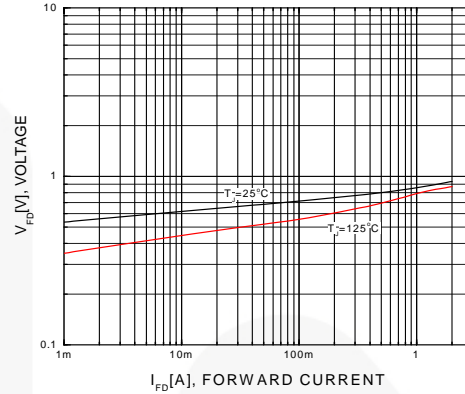

Figure 8. Diode Forward Voltage

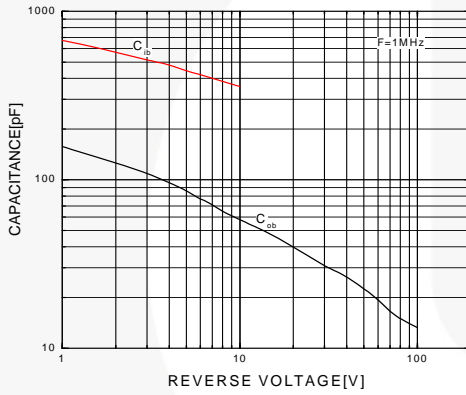

Figure 9. Collector Output Capacitance

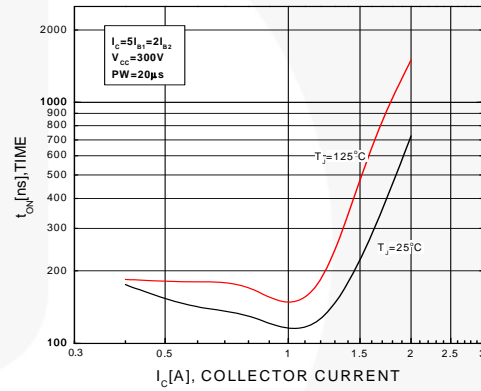

Figure 10. Resistive Switching Time, t_{on}

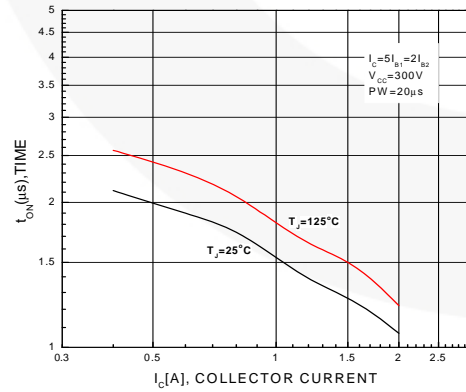

Figure 11. Resistive Switching Time, t_{off}

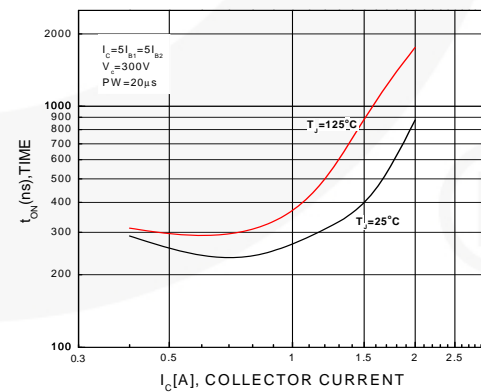

Figure 12. Resistive Switching Time, t_{on}

Typical Performance Characteristics (Continued)

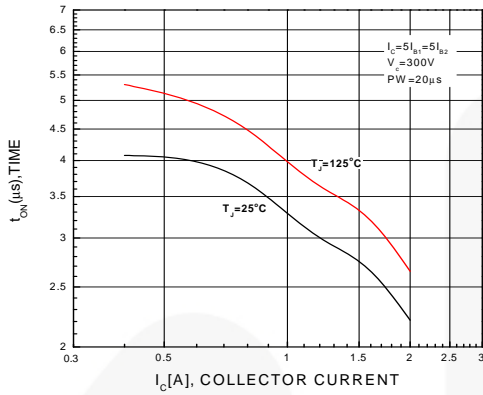

Figure 13. Resistive Switching Time, t_{off}

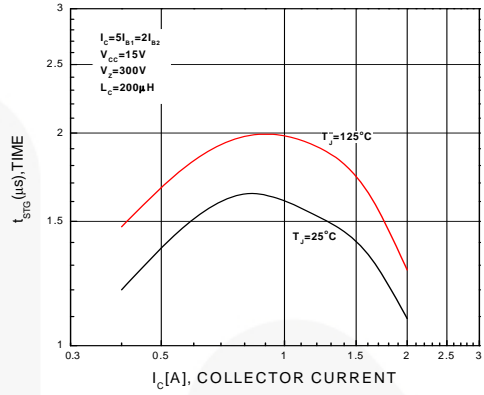

Figure 14. Inductive Switching Time, t_{STG}

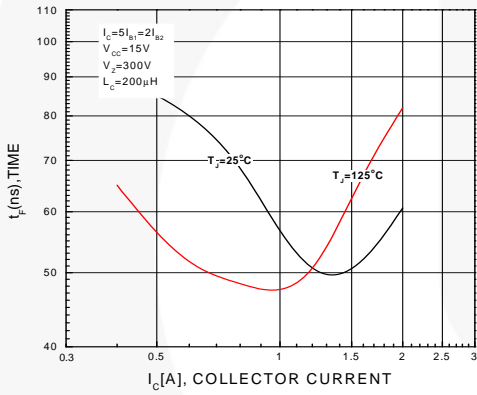

Figure 15. Inductive Switching Time, t_f

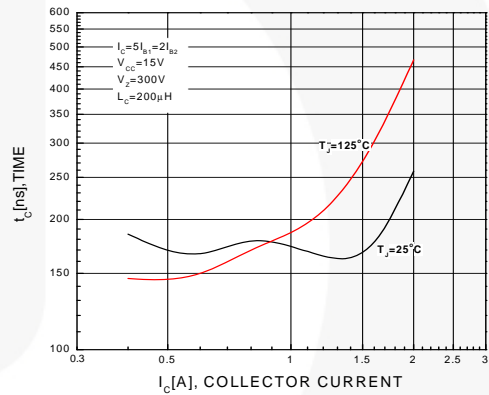

Figure 16. Inductive Switching Time, t_c

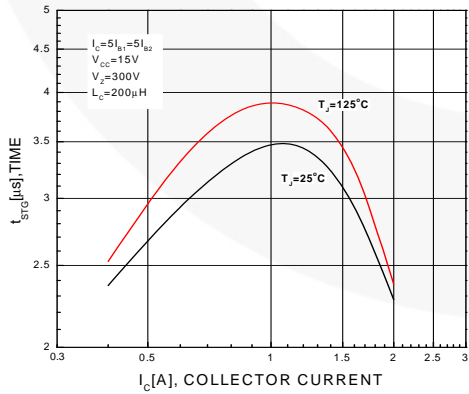

Figure 17. Inductive Switching Time, t_{STG}

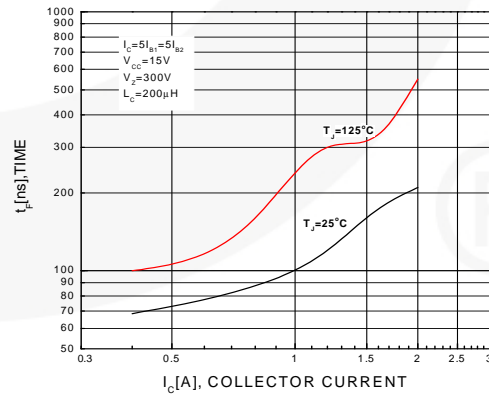

Figure 18. Inductive Switching Time, t_f

Typical Performance Characteristics (Continued)

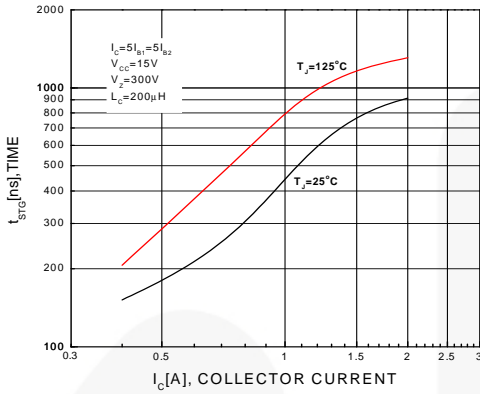

Figure 19. Inductive Switching Time, t_{STG}

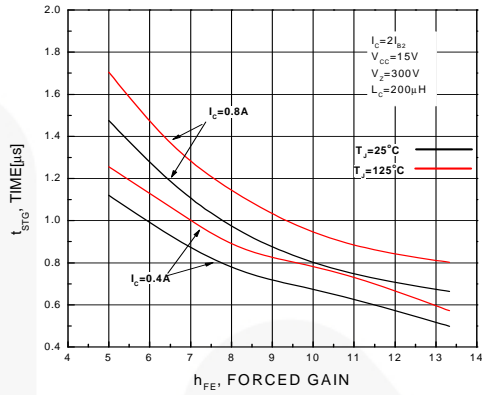

Figure 20. Inductive Switching Time, t_{STG}

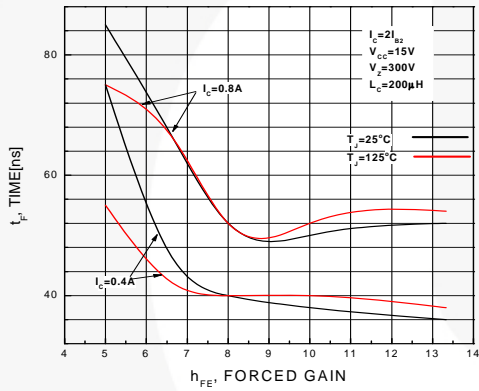

Figure 21. Inductive Switching Time, t_F

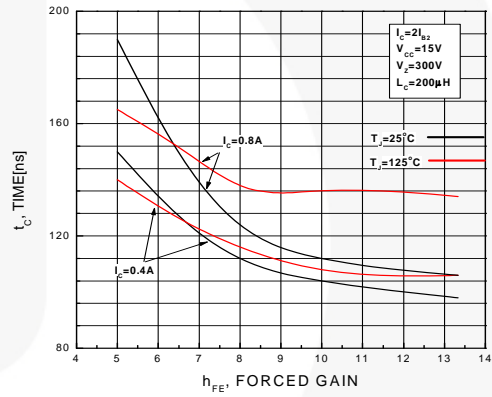

Figure 22. Inductive Switching Time, t_C

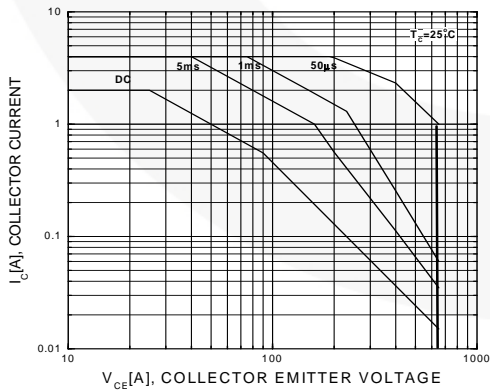

Figure 23. Forward Bias Safe Operating Area

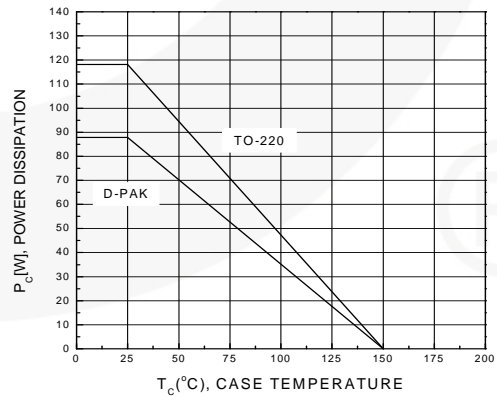

Figure 24. Power Derating

Typical Performance Characteristics (Continued)

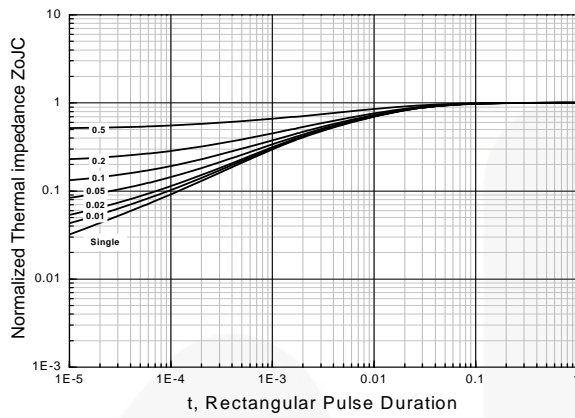

Figure 25. ZoJC, Transient Thermal Impedance (D-PAK)

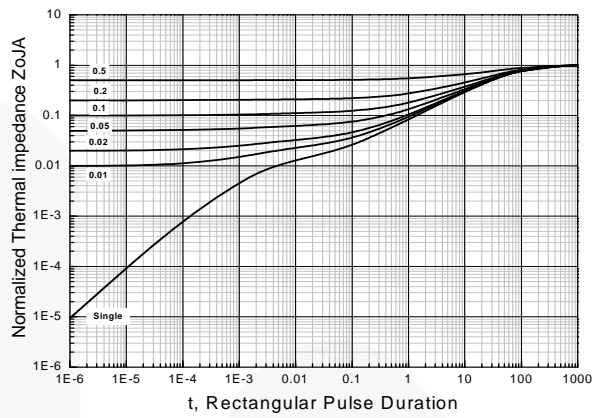

Figure 26. ZoJA, Transient Thermal Impedance (D-PAK)

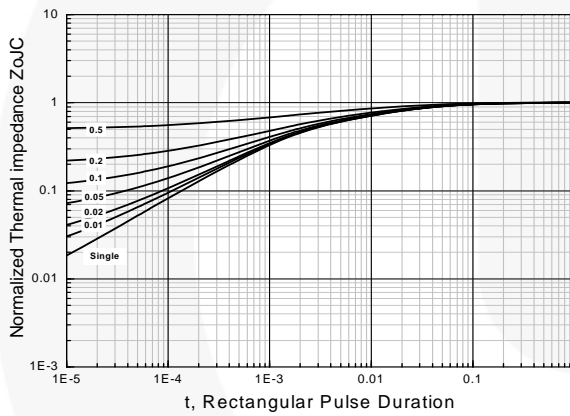

Figure 27. ZoJC, Transient Thermal Impedance (TO-220)

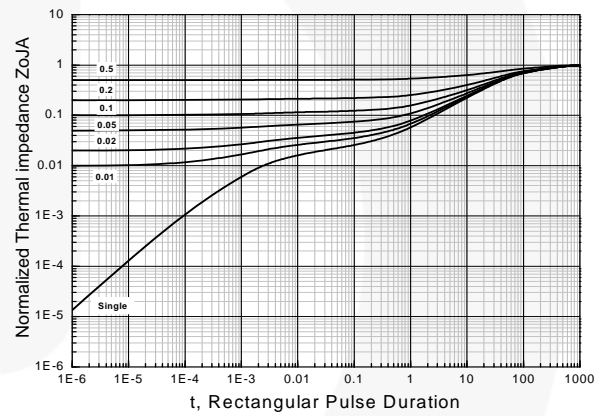

Figure 28. ZoJA, Transient Thermal Impedance (TO-220)

Physical Dimensions

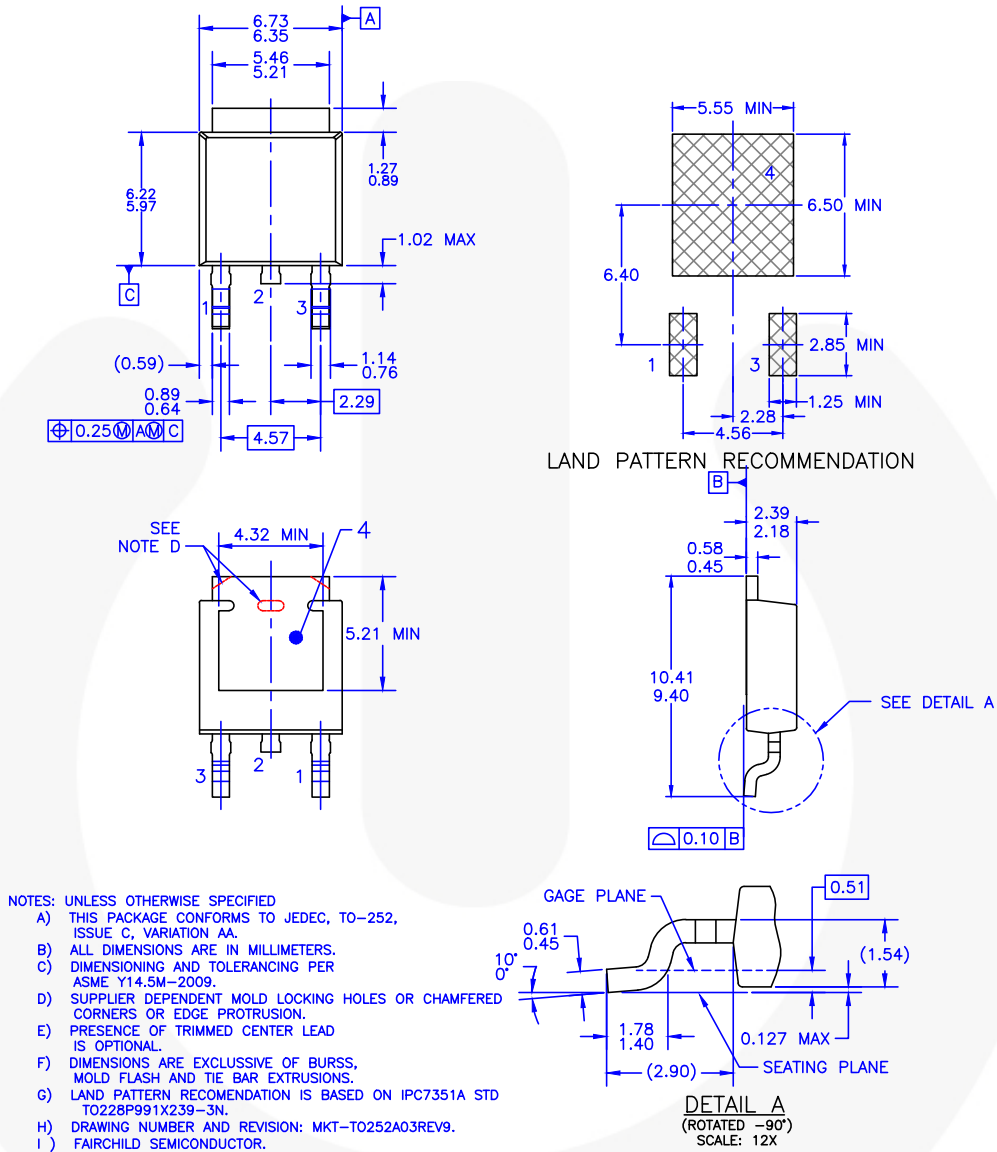

Figure 29. TO-252 (D-PAK), MOLDED, 3-LEAD, OPTION AA & AB

Package drawings are provided as a service to customers considering Fairchild components. Drawings may change in any manner without notice. Please note the revision and/or date on the drawing and contact a Fairchild Semiconductor representative to verify or obtain the most recent revision. Package specifications do not expand the terms of Fairchild's worldwide terms and conditions, specifically the warranty therein, which covers Fairchild products.

Always visit Fairchild Semiconductor's online packaging area for the most recent package drawings:
<http://www.fairchildsemi.com/dwg/TO/TO252A03.pdf>

For current tape and reel specifications, visit Fairchild Semiconductor's online packaging area:
http://www.fairchildsemi.com/packing_dwg/PKG-TO252A03.pdf

Physical Dimensions

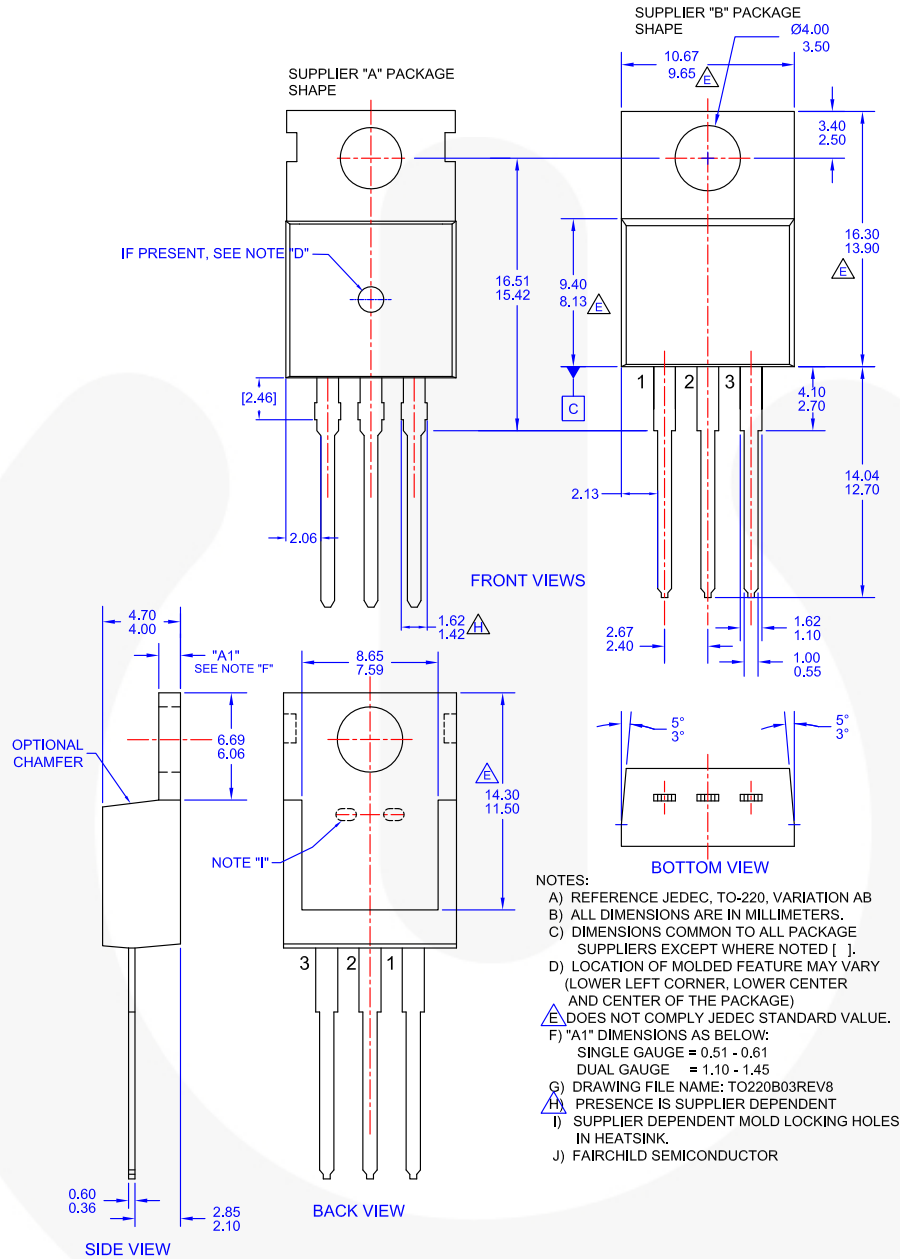

Figure 30. TO-220, MOLDED, 3LEAD, JEDEC VARIATION AB

Package drawings are provided as a service to customers considering Fairchild components. Drawings may change in any manner without notice. Please note the revision and/or date on the drawing and contact a Fairchild Semiconductor representative to verify or obtain the most recent revision. Package specifications do not expand the terms of Fairchild's worldwide terms and conditions, specifically the warranty therein, which covers Fairchild products.

Always visit Fairchild Semiconductor's online packaging area for the most recent package drawings:

<http://www.fairchildsemi.com/dwg/TO/TO220B03.pdf>

For current tape and reel specifications, visit Fairchild Semiconductor's online packaging area:

http://www.fairchildsemi.com/packaging_dwg/PKG-TO220B03.pdf





TRADEMARKS

The following includes registered and unregistered trademarks and service marks, owned by Fairchild Semiconductor and/or its global subsidiaries, and is not intended to be an exhaustive list of all such trademarks.

AccuPower™
 AX-CAP®*
 BitSiC™
 Build it Now™
 CorePLUS™
 CorePOWER™
 CROSSVOLT™
 CTL™
 Current Transfer Logic™
 DEUXPEED®
 Dual Cool™
 EcoSPARK®
 EfficientMax™
 ESBC™
 F®
 Fairchild®
 Fairchild Semiconductor®
 FACT Quiet Series™
 FACT®
 FAST®
 FastvCore™
 FETBench™
 FPS™

F-PFS™
 FRFET®
 Global Power ResourceSM
 GreenBridge™
 Green FPS™
 Green FPS™ e-Series™
 Gmax™
 GTO™
 IntelliMAX™
 ISOPLANAR™
 Making Small Speakers Sound Louder and Better™
 MegaBuck™
 MICROCOUPLER™
 MicroFET™
 MicroPak™
 MicroPak2™
 MillerDrive™
 MotionMax™
 mWSaver®
 OptoHiT™
 OPTOLOGIC®
 OPTOPLANAR®

 PowerTrench®
 PowerXS™
 Programmable Active Droop™
 QFET®
 QS™
 Quiet Series™
 RapidConfigure™

 Saving our world, 1mW/W/kW at a time™
 SignalWise™
 SmartMax™
 SMART START™
 Solutions for Your Success™
 SPM®
 STEALTH™
 SuperFET®
 SuperSOT™-3
 SuperSOT™-6
 SuperSOT™-8
 SupreMOS®
 SyncFET™
 Sync-Lock™

 SYSTEM GENERAL®
 TinyBoost®
 TinyBuck®
 TinyCalc™
 TinyLogic®
 TINYOPTO™
 TinyPower™
 TinyPWM™
 TinyWire™
 TranSiC™
 TriFault Detect™
 TRUECURRENT®*
 μSerDes™
 SerDes®
 UHC®
 Ultra FRFET™
 UniFET™
 VCX™
 VisualMax™
 VoltagePlus™
 XS™
 仙童™

* Trademarks of System General Corporation, used under license by Fairchild Semiconductor.

DISCLAIMER

FAIRCHILD SEMICONDUCTOR RESERVES THE RIGHT TO MAKE CHANGES WITHOUT FURTHER NOTICE TO ANY PRODUCTS HEREIN TO IMPROVE RELIABILITY, FUNCTION, OR DESIGN. FAIRCHILD DOES NOT ASSUME ANY LIABILITY ARISING OUT OF THE APPLICATION OR USE OF ANY PRODUCT OR CIRCUIT DESCRIBED HEREIN; NEITHER DOES IT CONVEY ANY LICENSE UNDER ITS PATENT RIGHTS, NOR THE RIGHTS OF OTHERS. THESE SPECIFICATIONS DO NOT EXPAND THE TERMS OF FAIRCHILD'S WORLDWIDE TERMS AND CONDITIONS, SPECIFICALLY THE WARRANTY THEREIN, WHICH COVERS THESE PRODUCTS.

LIFE SUPPORT POLICY

FAIRCHILD'S PRODUCTS ARE NOT AUTHORIZED FOR USE AS CRITICAL COMPONENTS IN LIFE SUPPORT DEVICES OR SYSTEMS WITHOUT THE EXPRESS WRITTEN APPROVAL OF FAIRCHILD SEMICONDUCTOR CORPORATION.

As used herein:

1. Life support devices or systems are devices or systems which, (a) are intended for surgical implant into the body or (b) support or sustain life, and (c) whose failure to perform when properly used in accordance with instructions for use provided in the labeling, can be reasonably expected to result in a significant injury of the user.
2. A critical component in any component of a life support, device, or system whose failure to perform can be reasonably expected to cause the failure of the life support device or system, or to affect its safety or effectiveness.

ANTI-COUNTERFEITING POLICY

Fairchild Semiconductor Corporation's Anti-Counterfeiting Policy. Fairchild's Anti-Counterfeiting Policy is also stated on our external website, www.fairchildsemi.com, under Sales Support.

Counterfeiting of semiconductor parts is a growing problem in the industry. All manufacturers of semiconductor products are experiencing counterfeiting of their parts. Customers who inadvertently purchase counterfeit parts experience many problems such as loss of brand reputation, substandard performance, failed applications, and increased cost of production and manufacturing delays. Fairchild is taking strong measures to protect ourselves and our customers from the proliferation of counterfeit parts. Fairchild strongly encourages customers to purchase Fairchild parts either directly from Fairchild or from Authorized Fairchild Distributors who are listed by country on our web page cited above. Products customers buy either from Fairchild directly or from Authorized Fairchild Distributors are genuine parts, have full traceability, meet Fairchild's quality standards for handling and storage and provide access to Fairchild's full range of up-to-date technical and product information. Fairchild and our Authorized Distributors will stand behind all warranties and will appropriately address any warranty issues that may arise. Fairchild will not provide any warranty coverage or other assistance for parts bought from Unauthorized Sources. Fairchild is committed to combat this global problem and encourage our customers to do their part in stopping this practice by buying direct or from authorized distributors.

PRODUCT STATUS DEFINITIONS

Definition of Terms

Datasheet Identification	Product Status	Definition
Advance Information	Formative / In Design	Datasheet contains the design specifications for product development. Specifications may change in any manner without notice.
Preliminary	First Production	Datasheet contains preliminary data; supplementary data will be published at a later date. Fairchild Semiconductor reserves the right to make changes at any time without notice to improve design.
No Identification Needed	Full Production	Datasheet contains final specifications. Fairchild Semiconductor reserves the right to make changes at any time without notice to improve the design.
Obsolete	Not In Production	Datasheet contains specifications on a product that is discontinued by Fairchild Semiconductor. The datasheet is for reference information only.

Rev. I68

ON Semiconductor and  are trademarks of Semiconductor Components Industries, LLC dba ON Semiconductor or its subsidiaries in the United States and/or other countries. ON Semiconductor owns the rights to a number of patents, trademarks, copyrights, trade secrets, and other intellectual property. A listing of ON Semiconductor's product/patent coverage may be accessed at www.onsemi.com/site/pdf/Patent-Marking.pdf. ON Semiconductor reserves the right to make changes without further notice to any products herein. ON Semiconductor makes no warranty, representation or guarantee regarding the suitability of its products for any particular purpose, nor does ON Semiconductor assume any liability arising out of the application or use of any product or circuit, and specifically disclaims any and all liability, including without limitation special, consequential or incidental damages. Buyer is responsible for its products and applications using ON Semiconductor products, including compliance with all laws, regulations and safety requirements or standards, regardless of any support or applications information provided by ON Semiconductor. "Typical" parameters which may be provided in ON Semiconductor data sheets and/or specifications can and do vary in different applications and actual performance may vary over time. All operating parameters, including "Typicals" must be validated for each customer application by customer's technical experts. ON Semiconductor does not convey any license under its patent rights nor the rights of others. ON Semiconductor products are not designed, intended, or authorized for use as a critical component in life support systems or any FDA Class 3 medical devices or medical devices with a same or similar classification in a foreign jurisdiction or any devices intended for implantation in the human body. Should Buyer purchase or use ON Semiconductor products for any such unintended or unauthorized application, Buyer shall indemnify and hold ON Semiconductor and its officers, employees, subsidiaries, affiliates, and distributors harmless against all claims, costs, damages, and expenses, and reasonable attorney fees arising out of, directly or indirectly, any claim of personal injury or death associated with such unintended or unauthorized use, even if such claim alleges that ON Semiconductor was negligent regarding the design or manufacture of the part. ON Semiconductor is an Equal Opportunity/Affirmative Action Employer. This literature is subject to all applicable copyright laws and is not for resale in any manner.

PUBLICATION ORDERING INFORMATION

LITERATURE FULFILLMENT:

Literature Distribution Center for ON Semiconductor
19521 E. 32nd Pkwy, Aurora, Colorado 80011 USA
Phone: 303-675-2175 or 800-344-3860 Toll Free USA/Canada
Fax: 303-675-2176 or 800-344-3867 Toll Free USA/Canada
Email: orderlit@onsemi.com

N. American Technical Support: 800-282-9855 Toll Free
USA/Canada
Europe, Middle East and Africa Technical Support:
Phone: 421 33 790 2910
Japan Customer Focus Center
Phone: 81-3-5817-1050

ON Semiconductor Website: www.onsemi.com
Order Literature: <http://www.onsemi.com/orderlit>
For additional information, please contact your local
Sales Representative