

## DKSV286

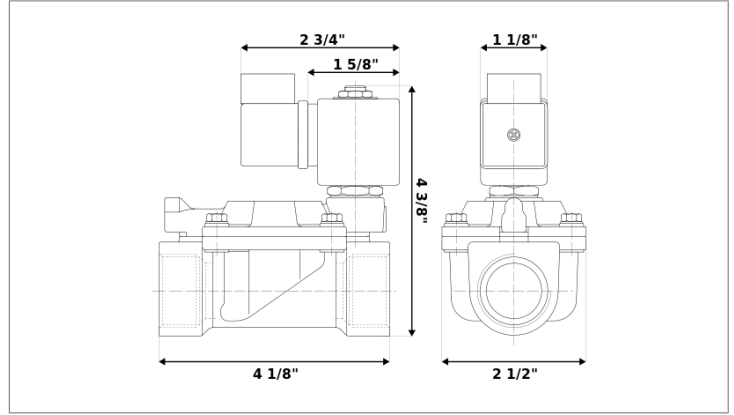

Normally closed, pilot operated, 2-way solenoid valve with low lead brass body and 1" connections



Valve	
Pipe size:	1" NPT
Operating pressure:	3–230 psi
Flow coefficient:	13 Cv
Media temperature:	15–180 °F
Ambient temperature:	15–105 °F
Suggested usage:	Potable water
Operation:	2-way, normally closed solenoid valve
Mechanism:	Pilot operated
Manual override:	No
Pipe gender:	Female
Orifice size:	1"
Design pressure:	360 psi
Media viscosity:	12 cSt

Electrical	
Power:	12 V dc
Wattage:	8 W
Connection:	Conduit (1/2" NPT)
Consumption:	0.67 A
Voltage tolerances:	+10% -5%
Coil inner diameter:	1/2"
Coil molding:	Polyamide (PA)
Coil rating:	15–310 °F (Class F)
Duty cycle:	Continuous, 100% ED
Enclosure:	NEMA 4, IP65

Materials	
Body:	Low lead brass
Seal:	EPDM rubber (EPDM)
Orifice:	Low lead brass
Core tube:	Stainless steel 300
Fixed core:	Stainless steel 400
Plunger:	Stainless steel 400
Spring:	Stainless steel 300
Shading ring:	Copper

Spare parts		
CORE TUBE	REPAIR KIT	COIL/CONNECTOR
AT-N0E1	RK-W0E2-02	C-D41
		
<ul style="list-style-type: none"> <li>Core tube</li> <li>Plunger</li> <li>O-ring</li> </ul>	<ul style="list-style-type: none"> <li>Diaphragm</li> <li>O-rings (2)</li> <li>Plunger</li> </ul>	<ul style="list-style-type: none"> <li>12 V dc electrical coil</li> <li>1/2" conduit connector</li> </ul>