

Data sheet | Item number: 2202-1401/000-001

4-conductor through terminal block; with push-button; 2.5 mm<sup>2</sup>; with test port; suitable for Ex e II applications; side and center marking; for DIN-rail 35 x 15 and 35 x 7.5; Push-in CAGE CLAMP®; 2,50 mm<sup>2</sup>; green

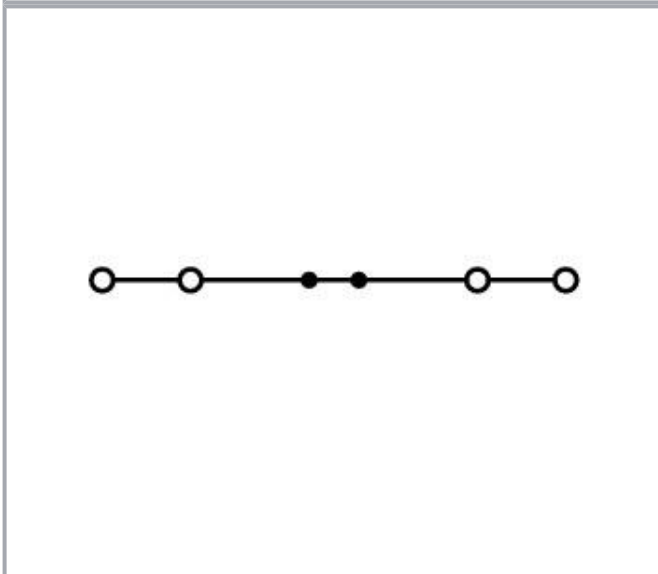

[www.wago.com/2202-1401/000-001](http://www.wago.com/2202-1401/000-001)

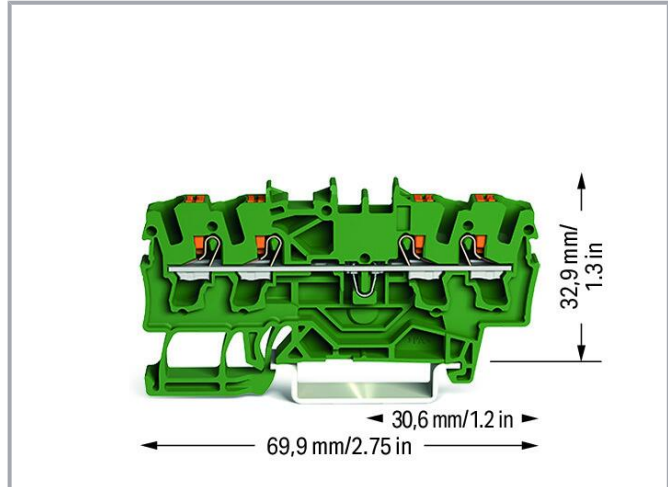

Subject to changes. Please also observe the further product documentation!

WAGO GmbH & Co. KG  
Hansastr. 27  
32423 Minden  
Phone: +49571 887-0 | Fax: +49571 887-169  
Email: [info.de@wago.com](mailto:info.de@wago.com) | Web: [www.wago.com](http://www.wago.com)

Do you have any questions about our products?  
We are always happy to take your call at +49 (571) 887-44222.



## Data

### Electrical data

#### Ratings per IEC/EN

|   |   |
|---|---|
| Ratings per   | IEC/EN 60947-7-1  |
| Nominal voltage (III/3)                                   | 800 V   |
| Rated impulse voltage (III/3)                             | 8 kV  |
| Rated current   | 24 A  |
| Current at conductor cross-section (max.) mm <sup>2</sup> | 32 A  |
| Legend (ratings)  | (III / 3) ≙ Overvoltage category III / Pollution degree 3 |

#### Ratings per UL 1059

|                                |         |
|--------------------------------|---------|
| Approvals per                  | UL 1059 |
| Rated voltage UL (Use Group B) | 600 V   |
| Rated current UL (Use Group B) | 20 A    |
| Rated voltage UL (Use Group C) | 600 V   |
| Rated current UL (Use Group C) | 20 A    |

#### Ratings per CSA

|                                 |                 |
|---------------------------------|-----------------|
| Approvals per                   | CSA 22.2 No 158 |
| Rated voltage CSA (Use Group B) | 600 V           |
| Rated current CSA (Use Group B) | 20 A            |
| Rated voltage CSA (Use Group C) | 600 V           |
| Rated current CSA (Use Group C) | 20 A            |

#### Ex information

|                                     |   |
|-------------------------------------|---|
| Reference hazardous areas           | See "Downloads – Documentation – Additional Information: Technical Section; Technical Explications" |
| Ratings per                         | ATEX: PTB 18 ATEX 1005 U / IECEx: PTB 18.0012U (Ex eb IIC Gb)                                       |
| Rated voltage EN (Ex e II)          | 550 V   |
| Rated current (Ex e II)             | 22 A  |
| Rated current (Ex e II) with jumper | 20 A  |

#### Power loss

|                                  |         |
|----------------------------------|---------|
| Power loss, per pole (potential) | 0.766 W |
|                                  | 24 A    |

Subject to changes. Please also observe the further product documentation!

Rated current  $I_N$  for specified power lossResistance value for specified, current-dependent power loss 0.001  $\Omega$ 

### Connection data

|                            |   |
|----------------------------|---|
| Connection points          | 4 |
| Total number of potentials | 1 |
| Number of levels           | 1 |
| Number of jumper slots     | 2 |

### Connection 1

|  |   |
|--|---|
| Connection technology                                      | Push-in CAGE CLAMP®   |
| Actuation type   | Push-button   |
| Connectable conductor materials                            | Copper  |
| Nominal cross-section                                      | 2.5 mm <sup>2</sup>   |
| Solid conductor  | 0.25 ... 4 mm <sup>2</sup> / 22 ... 12 AWG  |
| Solid conductor; push-in termination                       | 0.75 ... 4 mm <sup>2</sup> / 18 ... 12 AWG  |
| Fine-stranded conductor                                    | 0.25 ... 4 mm <sup>2</sup> / 22 ... 12 AWG  |
| Fine-stranded conductor; with insulated ferrule            | 0.25 ... 2.5 mm <sup>2</sup> / 22 ... 14 AWG  |
| Fine-stranded conductor; with ferrule; push-in termination | 1 ... 2.5 mm <sup>2</sup> / 18 ... 14 AWG   |
| Note (conductor cross-section)                             | Depending on the conductor characteristic, a conductor with a smaller cross-section can also be inserted via push-in termination. |
| Strip length   | 10 ... 12 mm / 0.39 ... 0.47 inches   |
| Wiring direction   | Front-entry wiring  |

### Physical data

|                                   |                        |
|-----------------------------------|------------------------|
| Width                             | 5.2 mm / 0.205 inches  |
| Height                            | 69.9 mm / 2.752 inches |
| Depth from upper-edge of DIN-rail | 32.9 mm / 1.295 inches |

### Mechanical Data

|               |                     |
|---------------|---------------------|
| Mounting type | DIN-35 rail         |
| Marking level | Center/side marking |

### Material Data

Note (material data)

Information on material specifications can be found here

Subject to changes. Please also observe the further product documentation!



|                             |                  |
|-----------------------------|------------------|
| Color                       | green            |
| Material group              | I                |
| Insulation material         | Polyamide (PA66) |
| Flammability class per UL94 | V0               |
| Fire load                   | 0.188 MJ         |
| Weight                      | 7.8 g            |

### Environmental requirements

|                                  |                 |
|----------------------------------|-----------------|
| Processing temperature           | -35 ... +85 °C  |
| Continuous operating temperature | -60 ... +105 °C |

### Commercial data



|                       |               |
|-----------------------|---------------|
| ETIM 8.0              | EC000897      |
| ETIM 7.0              | EC000897      |
| PU (SPU)              | 100 pcs       |
| Packaging type        | box           |
| Country of origin     | DE            |
| GTIN                  | 4066966097337 |
| Customs tariff number | 85369010000   |

### Environmental Product Compliance

|                        |                         |
|------------------------|-------------------------|
| RoHS Compliance Status | Compliant, No Exemption |
|------------------------|-------------------------|

### Required accessories

#### End plate





|  |   |  |
|--|---|--|
| End plate  |   |  |
|  | Item no.: 2002-1492<br>End and intermediate plate; 0.8 mm thick; orange | <a href="http://www.wago.com/2002-1492">www.wago.com/2002-1492</a> |
|  | Item no.: 2002-1491<br>End and intermediate plate; 0.8 mm thick; gray   | <a href="http://www.wago.com/2002-1491">www.wago.com/2002-1491</a> |

### Optional accessories

#### Carrier rail

|                      |
|----------------------|
| Mounting accessories |
|----------------------|

Subject to changes. Please also observe the further product documentation!

|  |  |  |
|--|--|--|
|    | <b>Item no.: 210-197</b><br>Steel carrier rail; 35 x 15 mm; 1.5 mm thick; 2 m long; slotted; similar to EN 60715; silver-colored                     | <a href="http://www.wago.com/210-197">www.wago.com/210-197</a> |
|    | <b>Item no.: 210-198</b><br>Copper carrier rail; 35 x 15 mm; 2.3 mm thick; 2 m long; unslotted; according to EN 60715; copper-colored                | <a href="http://www.wago.com/210-198">www.wago.com/210-198</a> |
|    | <b>Item no.: 210-504</b><br>Steel carrier rail; 35 x 7.5 mm; 1 mm thick; 2 m long; slotted; galvanized; according to EN 60715; silver-colored        | <a href="http://www.wago.com/210-504">www.wago.com/210-504</a> |
|    | <b>Item no.: 210-505</b><br>Steel carrier rail; 35 x 7.5 mm; 1 mm thick; 2 m long; unslotted; galvanized; according to EN 60715; silver-colored      | <a href="http://www.wago.com/210-505">www.wago.com/210-505</a> |
|    | <b>Item no.: 210-506</b><br>Steel carrier rail; 35 x 15 mm; 1.5 mm thick; 2 m long; unslotted; galvanized; similar to EN 60715; silver-colored       | <a href="http://www.wago.com/210-506">www.wago.com/210-506</a> |
|    | <b>Item no.: 210-508</b><br>Steel carrier rail; 35 x 15 mm; 1.5 mm thick; 2 m long; slotted; galvanized; similar to EN 60715; silver-colored         | <a href="http://www.wago.com/210-508">www.wago.com/210-508</a> |
|    | <b>Item no.: 210-113</b><br>Steel carrier rail; 35 x 7.5 mm; 1 mm thick; 2 m long; unslotted; according to EN 60715; silver-colored                  | <a href="http://www.wago.com/210-113">www.wago.com/210-113</a> |
|   | <b>Item no.: 210-118</b><br>Steel carrier rail; 35 x 15 mm; 2.3 mm thick; 2 m long; unslotted; according to EN 60715; silver-colored                 | <a href="http://www.wago.com/210-118">www.wago.com/210-118</a> |
|  | <b>Item no.: 210-112</b><br>Steel carrier rail; 35 x 7.5 mm; 1 mm thick; 2 m long; slotted; according to EN 60715; "Hole width 25 mm; silver-colored | <a href="http://www.wago.com/210-112">www.wago.com/210-112</a> |
|  | <b>Item no.: 210-114</b><br>Steel carrier rail; 35 x 15 mm; 1.5 mm thick; 2 m long; unslotted; similar to EN 60715; silver-colored                   | <a href="http://www.wago.com/210-114">www.wago.com/210-114</a> |
|  | <b>Item no.: 210-115</b><br>Steel carrier rail; 35 x 7.5 mm; 1 mm thick; 2 m long; slotted; according to EN 60715; "Hole width 18 mm; silver-colored | <a href="http://www.wago.com/210-115">www.wago.com/210-115</a> |
|  | <b>Item no.: 210-196</b><br>Aluminum carrier rail; 35 x 8.2 mm; 1.6 mm thick; 2 m long; unslotted; similar to EN 60715; silver-colored               | <a href="http://www.wago.com/210-196">www.wago.com/210-196</a> |

**Marking accessories**

Marking strip

|  |  |  |
|--|--|--|
|  | <b>Item no.: 2009-110</b><br>Marking strips; for Smart Printer; on reel; not stretchable; plain; snap-on type; white | <a href="http://www.wago.com/2009-110">www.wago.com/2009-110</a> |
|--|--|--|

Marker carrier













|  |  |  |
|--|--|--|
|  | <b>Item no.: 2009-198</b><br>Adaptor; gray | <a href="http://www.wago.com/2009-198">www.wago.com/2009-198</a> |
|  | <b>Item no.: 2002-161</b>                  |  |

Subject to changes. Please also observe the further product documentation!













Adaptor; gray

[www.wago.com/2002-161](http://www.wago.com/2002-161)

## Marker

|   |   |  |
|---|---|--|
|    | <b>Item no.: 2009-115/000-002</b><br>WMB-Inline; for Smart Printer; 1500 pieces on roll; stretchable 5 - 5.2 mm; plain; snap-on type; yellow      | <a href="http://www.wago.com/2009-115/000-002">www.wago.com/2009-115/000-002</a> |
|    | <b>Item no.: 2009-115/000-007</b><br>WMB-Inline; for Smart Printer; 1500 pieces on roll; stretchable 5 - 5.2 mm; plain; snap-on type; gray        | <a href="http://www.wago.com/2009-115/000-007">www.wago.com/2009-115/000-007</a> |
|    | <b>Item no.: 2009-115/000-017</b><br>WMB-Inline; for Smart Printer; 1500 pieces on roll; stretchable 5 - 5.2 mm; plain; snap-on type; light green | <a href="http://www.wago.com/2009-115/000-017">www.wago.com/2009-115/000-017</a> |
|    | <b>Item no.: 2009-115/000-023</b><br>WMB-Inline; for Smart Printer; 1500 pieces on roll; stretchable 5 - 5.2 mm; plain; snap-on type; green       | <a href="http://www.wago.com/2009-115/000-023">www.wago.com/2009-115/000-023</a> |
|    | <b>Item no.: 2009-115/000-024</b><br>WMB-Inline; for Smart Printer; 1500 pieces on roll; stretchable 5 - 5.2 mm; plain; snap-on type; violet      | <a href="http://www.wago.com/2009-115/000-024">www.wago.com/2009-115/000-024</a> |
|    | <b>Item no.: 2009-145/000-006</b><br>Mini-WSB Inline; for Smart Printer; 1700 pieces on roll; stretchable 5 - 5.2 mm; plain; snap-on type; blue   | <a href="http://www.wago.com/2009-145/000-006">www.wago.com/2009-145/000-006</a> |
|  | <b>Item no.: 2009-145</b><br>Mini-WSB Inline; for Smart Printer; 1700 pieces on roll; stretchable 5 - 5.2 mm; plain; snap-on type; white          | <a href="http://www.wago.com/2009-145">www.wago.com/2009-145</a>                 |
|  | <b>Item no.: 2009-145/000-002</b><br>Mini-WSB Inline; for Smart Printer; 1700 pieces on roll; stretchable 5 - 5.2 mm; plain; snap-on type; yellow | <a href="http://www.wago.com/2009-145/000-002">www.wago.com/2009-145/000-002</a> |
|  | <b>Item no.: 2009-145/000-007</b><br>Mini-WSB Inline; for Smart Printer; 1700 pieces on roll; stretchable 5 - 5.2 mm; plain; snap-on type; gray   | <a href="http://www.wago.com/2009-145/000-007">www.wago.com/2009-145/000-007</a> |
|  | <b>Item no.: 2009-145/000-005</b><br>Mini-WSB Inline; for Smart Printer; 1700 pieces on roll; stretchable 5 - 5.2 mm; plain; snap-on type; red    | <a href="http://www.wago.com/2009-145/000-005">www.wago.com/2009-145/000-005</a> |
|  | <b>Item no.: 2009-145/000-012</b><br>Mini-WSB Inline; for Smart Printer; 1700 pieces on roll; stretchable 5 - 5.2 mm; plain; snap-on type; orange | <a href="http://www.wago.com/2009-145/000-012">www.wago.com/2009-145/000-012</a> |
|  | <b>Item no.: 2009-145/000-023</b><br>Mini-WSB Inline; for Smart Printer; 1700 pieces on roll; stretchable 5 - 5.2 mm; plain; snap-on type; green  | <a href="http://www.wago.com/2009-145/000-023">www.wago.com/2009-145/000-023</a> |

Subject to changes. Please also observe the further product documentation!

|  |   |  |
|--|---|--|
|    | <b>Item no.: 2009-145/000-024</b><br>Mini-WSB Inline; for Smart Printer; 1700 pieces on roll; stretchable 5 - 5.2 mm; plain; snap-on type; violet       | <a href="http://www.wago.com/2009-145/000-024">www.wago.com/2009-145/000-024</a> |
|    | <b>Item no.: 2009-115</b><br>WMB-Inline; for Smart Printer; 1500 pieces on roll; stretchable 5 - 5.2 mm; plain; snap-on type; white                     | <a href="http://www.wago.com/2009-115">www.wago.com/2009-115</a>                 |
|    | <b>Item no.: 248-501/000-006</b><br>Mini-WSB marking card; as card; not stretchable; plain; snap-on type; blue  | <a href="http://www.wago.com/248-501/000-006">www.wago.com/248-501/000-006</a>   |
|    | <b>Item no.: 248-501/000-007</b><br>Mini-WSB marking card; as card; not stretchable; plain; snap-on type; gray  | <a href="http://www.wago.com/248-501/000-007">www.wago.com/248-501/000-007</a>   |
|    | <b>Item no.: 248-501/000-002</b><br>Mini-WSB marking card; as card; not stretchable; plain; snap-on type; yellow  | <a href="http://www.wago.com/248-501/000-002">www.wago.com/248-501/000-002</a>   |
|    | <b>Item no.: 248-501/000-012</b><br>Mini-WSB marking card; as card; not stretchable; plain; snap-on type; orange  | <a href="http://www.wago.com/248-501/000-012">www.wago.com/248-501/000-012</a>   |
|   | <b>Item no.: 248-501</b><br>Mini-WSB marking card; as card; not stretchable; plain; snap-on type; white   | <a href="http://www.wago.com/248-501">www.wago.com/248-501</a>                   |
|  | <b>Item no.: 248-501/000-017</b><br>Mini-WSB marking card; as card; not stretchable; plain; snap-on type; light green                                   | <a href="http://www.wago.com/248-501/000-017">www.wago.com/248-501/000-017</a>   |
|  | <b>Item no.: 248-501/000-005</b><br>Mini-WSB marking card; as card; not stretchable; plain; snap-on type; red   | <a href="http://www.wago.com/248-501/000-005">www.wago.com/248-501/000-005</a>   |
|  | <b>Item no.: 248-501/000-024</b><br>Mini-WSB marking card; as card; not stretchable; plain; snap-on type; violet  | <a href="http://www.wago.com/248-501/000-024">www.wago.com/248-501/000-024</a>   |
|  | <b>Item no.: 248-501/000-023</b><br>Mini-WSB marking card; as card; not stretchable; plain; snap-on type; green   | <a href="http://www.wago.com/248-501/000-023">www.wago.com/248-501/000-023</a>   |
|  | <b>Item no.: 793-5501/000-007</b><br>WMB marking card; as card; for terminal block width 5 - 17.5 mm; stretchable 5 - 5.2 mm; plain; snap-on type; gray | <a href="http://www.wago.com/793-5501/000-007">www.wago.com/793-5501/000-007</a> |

Subject to changes. Please also observe the further product documentation!



Item no.: 793-5501/000-012

WMB marking card; as card; for terminal block width 5 - 17.5 mm; stretchable 5 - 5.2 mm; plain; snap-on type; orange

[www.wago.com/793-5501/000-012](http://www.wago.com/793-5501/000-012)



Item no.: 793-5501/000-014

WMB marking card; as card; for terminal block width 5 - 17.5 mm; stretchable 5 - 5.2 mm; plain; snap-on type; brown

[www.wago.com/793-5501/000-014](http://www.wago.com/793-5501/000-014)



Item no.: 793-5501/000-017

WMB marking card; as card; for terminal block width 5 - 17.5 mm; stretchable 5 - 5.2 mm; plain; snap-on type; light green

[www.wago.com/793-5501/000-017](http://www.wago.com/793-5501/000-017)



Item no.: 793-5501/000-023

WMB marking card; as card; for terminal block width 5 - 17.5 mm; stretchable 5 - 5.2 mm; plain; snap-on type; green

[www.wago.com/793-5501/000-023](http://www.wago.com/793-5501/000-023)



Item no.: 793-5501/000-024

WMB marking card; as card; for terminal block width 5 - 17.5 mm; stretchable 5 - 5.2 mm; plain; snap-on type; violet

[www.wago.com/793-5501/000-024](http://www.wago.com/793-5501/000-024)



Item no.: 793-5501/000-005

WMB marking card; as card; for terminal block width 5 - 17.5 mm; stretchable 5 - 5.2 mm; plain; snap-on type; red

[www.wago.com/793-5501/000-005](http://www.wago.com/793-5501/000-005)



Item no.: 793-5501/000-002

WMB marking card; as card; for terminal block width 5 - 17.5 mm; stretchable 5 - 5.2 mm; plain; snap-on type; yellow

[www.wago.com/793-5501/000-002](http://www.wago.com/793-5501/000-002)



Item no.: 793-5501/000-006

WMB marking card; as card; for terminal block width 5 - 17.5 mm; stretchable 5 - 5.2 mm; plain; snap-on type; blue

[www.wago.com/793-5501/000-006](http://www.wago.com/793-5501/000-006)



Item no.: 793-5501

WMB marking card; as card; for terminal block width 5 - 17.5 mm; stretchable 5 - 5.2 mm; plain; snap-on type; white

[www.wago.com/793-5501](http://www.wago.com/793-5501)



Item no.: 2009-115/000-012

WMB-Inline; for Smart Printer; 1500 pieces on roll; stretchable 5 - 5.2 mm; plain; snap-on type; orange

[www.wago.com/2009-115/000-012](http://www.wago.com/2009-115/000-012)



Item no.: 2009-115/000-006

WMB-Inline; for Smart Printer; 1500 pieces on roll; stretchable 5 - 5.2 mm; plain; snap-on type; blue

[www.wago.com/2009-115/000-006](http://www.wago.com/2009-115/000-006)

Subject to changes. Please also observe the further product documentation!

WAGO GmbH & Co. KG

Hansastr. 27

32423 Minden

Phone: +49571 887-0 | Fax: +49571 887-169

Email: [info.de@wago.com](mailto:info.de@wago.com) | Web: [www.wago.com](http://www.wago.com)

Do you have any questions about our products?

We are always happy to take your call at +49 (571) 887-44222.





**Item no.: 2009-115/000-005**

WMB-Inline; for Smart Printer; 1500 pieces on roll; stretchable 5 - 5.2 mm; plain; snap-on type; red









[www.wago.com/2009-115/000-005](http://www.wago.com/2009-115/000-005)

## Group marker carrier

|   |   |  |
|---|---|--|
|  | <b>Item no.: 2009-193</b><br>Group marker carrier; gray | <a href="http://www.wago.com/2009-193">www.wago.com/2009-193</a> |
|  | <b>Item no.: 2009-192</b><br>Group marker carrier; gray | <a href="http://www.wago.com/2009-192">www.wago.com/2009-192</a> |
|  | <b>Item no.: 2009-191</b><br>Group marker carrier; gray | <a href="http://www.wago.com/2009-191">www.wago.com/2009-191</a> |

## Ferrule

## Ferrule

|   |  |  |
|---|--|--|
|    | <b>Item no.: 216-241</b><br>Ferrule; Sleeve for 0.5 mm <sup>2</sup> / 20 AWG; insulated; electro-tin plated; electrolytic copper; gastight crimped; acc. to DIN 46228, Part 4/09.90; white | <a href="http://www.wago.com/216-241">www.wago.com/216-241</a> |
|    | <b>Item no.: 216-242</b><br>Ferrule; Sleeve for 0.75 mm <sup>2</sup> / 18 AWG; insulated; electro-tin plated; electrolytic copper; gastight crimped; acc. to DIN 46228, Part 4/09.90; gray | <a href="http://www.wago.com/216-242">www.wago.com/216-242</a> |
|    | <b>Item no.: 216-243</b><br>Ferrule; Sleeve for 1 mm <sup>2</sup> / AWG 18; insulated; electro-tin plated; electrolytic copper; gastight crimped; acc. to DIN 46228, Part 4/09.90; red     | <a href="http://www.wago.com/216-243">www.wago.com/216-243</a> |
|  | <b>Item no.: 216-244</b><br>Ferrule; Sleeve for 1.5 mm <sup>2</sup> / AWG 16; insulated; electro-tin plated; electrolytic copper; gastight crimped; acc. to DIN 46228, Part 4/09.90; black | <a href="http://www.wago.com/216-244">www.wago.com/216-244</a> |
|  | <b>Item no.: 216-263</b><br>Ferrule; Sleeve for 1 mm <sup>2</sup> / AWG 18; insulated; electro-tin plated; electrolytic copper; gastight crimped; acc. to DIN 46228, Part 4/09.90; red     | <a href="http://www.wago.com/216-263">www.wago.com/216-263</a> |
|  | <b>Item no.: 216-246</b><br>Ferrule; Sleeve for 2.5 mm <sup>2</sup> / AWG 14; insulated; electro-tin plated; electrolytic copper; gastight crimped; acc. to DIN 46228, Part 4/09.90; blue  | <a href="http://www.wago.com/216-246">www.wago.com/216-246</a> |
|  | <b>Item no.: 216-266</b><br>Ferrule; Sleeve for 2.5 mm <sup>2</sup> / AWG 14; insulated; electro-tin plated; electrolytic copper; gastight crimped; acc. to DIN 46228, Part 4/09.90; blue  | <a href="http://www.wago.com/216-266">www.wago.com/216-266</a> |
|  | <b>Item no.: 216-264</b><br>Ferrule; Sleeve for 1.5 mm <sup>2</sup> / AWG 16; insulated; electro-tin plated; electrolytic copper; gastight crimped; acc. to DIN 46228, Part 4/09.90; black | <a href="http://www.wago.com/216-264">www.wago.com/216-264</a> |
|  | <b>Item no.: 216-262</b><br>Ferrule; Sleeve for 0.75 mm <sup>2</sup> / 18 AWG; insulated; electro-tin plated; electrolytic copper; gastight crimped; acc. to DIN 46228, Part 4/09.90; gray | <a href="http://www.wago.com/216-262">www.wago.com/216-262</a> |

## Plugs

## Diode plug

|   |  |  |
|---|--|--|
|  | <b>Item no.: 2002-880/1000-411</b><br>Component plug; 2-pole; with diode 1N4007; 10.4 mm wide; Operating temperature 85°C max.; gray | <a href="http://www.wago.com/2002-880/1000-411">www.wago.com/2002-880/1000-411</a> |
|---|--|--|

Subject to changes. Please also observe the further product documentation!

## LED plug

**Item no.: 2002-880/1000-541**

Component plug; 2-pole; LED (red); 10.4 mm wide; Operating temperature 85°C max.; gray

[www.wago.com/2002-880/1000-541](http://www.wago.com/2002-880/1000-541)**Item no.: 2002-880/1000-542**

Component plug; 2-pole; LED (red); 10.4 mm wide; Operating temperature 85°C max.; multicoloured

[www.wago.com/2002-880/1000-542](http://www.wago.com/2002-880/1000-542)**Item no.: 2002-880/1000-836**

Component plug; 2-pole; LED (red); 10.4 mm wide; Operating temperature 85°C max.; gray

[www.wago.com/2002-880/1000-836](http://www.wago.com/2002-880/1000-836)

## Empty component plug housing

**Item no.: 2002-880**

Empty component plug housing; 10.4 mm wide; 2-pole; Type 4; gray

[www.wago.com/2002-880](http://www.wago.com/2002-880)

## Push-in type wire jumper

## Jumper

**Item no.: 2009-412**

Push-in type wire jumper; insulated; 60 mm long; black

[www.wago.com/2009-412](http://www.wago.com/2009-412)**Item no.: 2009-414**Push-in type wire jumper; 1.5 mm<sup>2</sup>; insulated; 110 mm long; black[www.wago.com/2009-414](http://www.wago.com/2009-414)**Item no.: 2009-416**Push-in type wire jumper; 1.5 mm<sup>2</sup>; insulated; 250 mm long; black[www.wago.com/2009-416](http://www.wago.com/2009-416)**Item no.: 2009-414/000-005**Push-in type wire jumper; 1.5 mm<sup>2</sup>; insulated; 110 mm long; black[www.wago.com/2009-414/000-005](http://www.wago.com/2009-414/000-005)**Item no.: 2009-414/000-006**

Push-in type wire jumper; insulated; 110 mm long; black

[www.wago.com/2009-414/000-006](http://www.wago.com/2009-414/000-006)

## Tool

## Operating tool

**Item no.: 210-658**

Operating tool; Blade: 3.5 x 0.5 mm; with a partially insulated shaft; angled; short; multicoloured

[www.wago.com/210-658](http://www.wago.com/210-658)**Item no.: 210-720**

Operating tool; Blade: 3.5 x 0.5 mm; with a partially insulated shaft; multicoloured

[www.wago.com/210-720](http://www.wago.com/210-720)

## Mounting

## Cover carrier

Subject to changes. Please also observe the further product documentation!

WAGO GmbH &amp; Co. KG

Hansastr. 27

32423 Minden

Phone: +49571 887-0 | Fax: +49571 887-169

Email: [info.de@wago.com](mailto:info.de@wago.com) | Web: [www.wago.com](http://www.wago.com)

Do you have any questions about our products?

We are always happy to take your call at +49 (571) 887-44222.



**Item no.: 709-169**  
Cover carrier; Type 3; gray

[www.wago.com/709-169](http://www.wago.com/709-169)

Cover



**Item no.: 709-156**  
Cover; Type 3; suitable for cover carrier, type 3; 1 m long; transparent

[www.wago.com/709-156](http://www.wago.com/709-156)

## Testing and measuring

### Testing accessories



**Item no.: 2009-174**  
Test plug adapter; for 4 mm Ø test plugs; for testing TOPJOB®S rail-mounted terminal blocks; gray

[www.wago.com/2009-174](http://www.wago.com/2009-174)



**Item no.: 2009-182**  
Testing tap; for max. 2.5 mm<sup>2</sup>; tool-free connection for individual test wires 0.08 - 2.5 mm; gray

[www.wago.com/2009-182](http://www.wago.com/2009-182)



**Item no.: 2002-511**  
Modular TOPJOB®S connector; modular; for jumper contact slot; 1-pole; 2,50 mm<sup>2</sup>; gray

[www.wago.com/2002-511](http://www.wago.com/2002-511)



**Item no.: 2002-549**  
Spacer module; modular; e.g., for bridging commoned terminal blocks; gray

[www.wago.com/2002-549](http://www.wago.com/2002-549)



**Item no.: 2002-552**  
Modular TOPJOB®S connector; modular; for jumper contact slot; 2-pole; 2,50 mm<sup>2</sup>; gray

[www.wago.com/2002-552](http://www.wago.com/2002-552)



**Item no.: 2002-558**  
Modular TOPJOB®S connector; modular; for jumper contact slot; 8-pole; 2,50 mm<sup>2</sup>; gray

[www.wago.com/2002-558](http://www.wago.com/2002-558)



**Item no.: 2002-559**  
Modular TOPJOB®S connector; modular; for jumper contact slot; 9-pole; 2,50 mm<sup>2</sup>; gray

[www.wago.com/2002-559](http://www.wago.com/2002-559)



**Item no.: 2002-556**  
Modular TOPJOB®S connector; modular; for jumper contact slot; 6-pole; 2,50 mm<sup>2</sup>; gray

[www.wago.com/2002-556](http://www.wago.com/2002-556)



**Item no.: 2002-553**  
Modular TOPJOB®S connector; modular; for jumper contact slot; 3-pole; 2,50 mm<sup>2</sup>; gray

[www.wago.com/2002-553](http://www.wago.com/2002-553)



**Item no.: 2002-560**  
Modular TOPJOB®S connector; modular; for jumper contact slot; 10-pole; 2,50 mm<sup>2</sup>; gray

[www.wago.com/2002-560](http://www.wago.com/2002-560)



**Item no.: 2002-554**  
Modular TOPJOB®S connector; modular; for jumper contact slot; 4-pole; 2,50 mm<sup>2</sup>; gray

[www.wago.com/2002-554](http://www.wago.com/2002-554)



**Item no.: 2002-555**  
Modular TOPJOB®S connector; modular; for jumper contact slot; 5-pole; 2,50 mm<sup>2</sup>; gray

[www.wago.com/2002-555](http://www.wago.com/2002-555)



**Item no.: 2002-557**  
Modular TOPJOB®S connector; modular; for jumper contact slot; 7-pole; 2,50 mm<sup>2</sup>; gray

[www.wago.com/2002-557](http://www.wago.com/2002-557)



**Item no.: 2002-649**  
TOPJOB®S L-type spacer module; modular; e.g., for bridging commoned terminal blocks; gray

[www.wago.com/2002-649](http://www.wago.com/2002-649)

Subject to changes. Please also observe the further product documentation!

---

**Jumpers**

---

**Jumper**

---

**Item no.: 210-123**

Wire commoning chain; insulated; blue

[www.wago.com/210-123](http://www.wago.com/210-123)**Item no.: 2006-499**

Step-down jumper; from 2006/2004 to 2004/2002/2001 series; from 2206/2204 to 2204/2202/2201 series; insulated; light gray

[www.wago.com/2006-499](http://www.wago.com/2006-499)**Item no.: 2002-402**

Jumper; 2-way; insulated; light gray

[www.wago.com/2002-402](http://www.wago.com/2002-402)**Item no.: 2002-402/000-005**

Jumper; 2-way; insulated; red

[www.wago.com/2002-402/000-005](http://www.wago.com/2002-402/000-005)**Item no.: 2002-400**

Continuous jumper; 2-way; insulated; light gray

[www.wago.com/2002-400](http://www.wago.com/2002-400)**Item no.: 2002-403**

Jumper; 3-way; insulated; light gray

[www.wago.com/2002-403](http://www.wago.com/2002-403)**Item no.: 2002-404/000-005**

Jumper; 4-way; insulated; red

[www.wago.com/2002-404/000-005](http://www.wago.com/2002-404/000-005)**Item no.: 2002-403/000-006**

Jumper; 3-way; insulated; blue

[www.wago.com/2002-403/000-006](http://www.wago.com/2002-403/000-006)**Item no.: 2002-404/000-006**

Jumper; 4-way; insulated; blue

[www.wago.com/2002-404/000-006](http://www.wago.com/2002-404/000-006)**Item no.: 2002-403/000-005**

Jumper; 3-way; insulated; red

[www.wago.com/2002-403/000-005](http://www.wago.com/2002-403/000-005)**Item no.: 2002-405/000-005**

Jumper; 5-way; insulated; red

[www.wago.com/2002-405/000-005](http://www.wago.com/2002-405/000-005)**Item no.: 2002-402/000-006**

Jumper; 2-way; insulated; blue

[www.wago.com/2002-402/000-006](http://www.wago.com/2002-402/000-006)**Item no.: 2002-405/000-006**

Jumper; 5-way; insulated; blue

[www.wago.com/2002-405/000-006](http://www.wago.com/2002-405/000-006)**Item no.: 2002-404**

Jumper; 4-way; insulated; light gray

[www.wago.com/2002-404](http://www.wago.com/2002-404)

Subject to changes. Please also observe the further product documentation!

WAGO GmbH &amp; Co. KG

Hansastr. 27













32423 Minden

Phone: +49571 887-0 | Fax: +49571 887-169















Email: [info.de@wago.com](mailto:info.de@wago.com) | Web: [www.wago.com](http://www.wago.com)

Do you have any questions about our products?

We are always happy to take your call at +49 (571) 887-44222.

|  |  |  |
|--|--|--|
|    | <b>Item no.: 2002-406/000-006</b><br>Jumper; 6-way; insulated; blue                  | <a href="http://www.wago.com/2002-406/000-006">www.wago.com/2002-406/000-006</a> |
|    | <b>Item no.: 2002-406/000-005</b><br>Jumper; 6-way; insulated; red                   | <a href="http://www.wago.com/2002-406/000-005">www.wago.com/2002-406/000-005</a> |
|    | <b>Item no.: 2002-406/020-000</b><br>Delta jumper; insulated; light gray             | <a href="http://www.wago.com/2002-406/020-000">www.wago.com/2002-406/020-000</a> |
|    | <b>Item no.: 2002-405</b><br>Jumper; 5-way; insulated; light gray                    | <a href="http://www.wago.com/2002-405">www.wago.com/2002-405</a>                 |
|    | <b>Item no.: 2002-407/000-005</b><br>Jumper; 7-way; insulated; red                   | <a href="http://www.wago.com/2002-407/000-005">www.wago.com/2002-407/000-005</a> |
|    | <b>Item no.: 2002-408</b><br>Jumper; 8-way; insulated; light gray                    | <a href="http://www.wago.com/2002-408">www.wago.com/2002-408</a>                 |
|  | <b>Item no.: 2002-408/000-006</b><br>Jumper; 8-way; insulated; blue                  | <a href="http://www.wago.com/2002-408/000-006">www.wago.com/2002-408/000-006</a> |
|  | <b>Item no.: 2002-405/011-000</b><br>Star point jumper; 3-way; insulated; light gray | <a href="http://www.wago.com/2002-405/011-000">www.wago.com/2002-405/011-000</a> |
|  | <b>Item no.: 2002-407/000-006</b><br>Jumper; 7-way; insulated; blue                  | <a href="http://www.wago.com/2002-407/000-006">www.wago.com/2002-407/000-006</a> |
|  | <b>Item no.: 2002-408/000-005</b><br>Jumper; 8-way; insulated; red                   | <a href="http://www.wago.com/2002-408/000-005">www.wago.com/2002-408/000-005</a> |
|  | <b>Item no.: 2002-407</b><br>Jumper; 7-way; insulated; light gray                    | <a href="http://www.wago.com/2002-407">www.wago.com/2002-407</a>                 |
|  | <b>Item no.: 2002-406</b><br>Jumper; 6-way; insulated; light gray                    | <a href="http://www.wago.com/2002-406">www.wago.com/2002-406</a>                 |

Subject to changes. Please also observe the further product documentation!

|   |  |  |
|---|--|--|
|   | <b>Item no.:</b> 2002-410/000-005<br>Jumper; 10-way; insulated; red                  | <a href="http://www.wago.com/2002-410/000-005">www.wago.com/2002-410/000-005</a> |
|   | <b>Item no.:</b> 2002-410/000-006<br>Jumper; 10-way; insulated; blue                 | <a href="http://www.wago.com/2002-410/000-006">www.wago.com/2002-410/000-006</a> |
|   | <b>Item no.:</b> 2002-410<br>Jumper; 10-way; insulated; light gray                   | <a href="http://www.wago.com/2002-410">www.wago.com/2002-410</a>                 |
|   | <b>Item no.:</b> 2002-409/000-006<br>Jumper; 9-way; insulated; blue                  | <a href="http://www.wago.com/2002-409/000-006">www.wago.com/2002-409/000-006</a> |
|   | <b>Item no.:</b> 2002-409/000-005<br>Jumper; 9-way; insulated; red                   | <a href="http://www.wago.com/2002-409/000-005">www.wago.com/2002-409/000-005</a> |
|   | <b>Item no.:</b> 2002-409<br>Jumper; 9-way; insulated; light gray                    | <a href="http://www.wago.com/2002-409">www.wago.com/2002-409</a>                 |
|   | <b>Item no.:</b> 2002-423/000-006<br>Continuous jumper; from 1 to 3; insulated; blue | <a href="http://www.wago.com/2002-423/000-006">www.wago.com/2002-423/000-006</a> |
|  | <b>Item no.:</b> 2002-423<br>Continuous jumper; from 1 to 3; insulated; light gray   | <a href="http://www.wago.com/2002-423">www.wago.com/2002-423</a>                 |
|  | <b>Item no.:</b> 2002-433<br>Jumper; from 1 to 3; insulated; light gray              | <a href="http://www.wago.com/2002-433">www.wago.com/2002-433</a>                 |
|  | <b>Item no.:</b> 2002-434<br>Jumper; from 1 to 4; insulated; light gray              | <a href="http://www.wago.com/2002-434">www.wago.com/2002-434</a>                 |
|  | <b>Item no.:</b> 2002-423/000-005<br>Continuous jumper; from 1 to 3; insulated; red  | <a href="http://www.wago.com/2002-423/000-005">www.wago.com/2002-423/000-005</a> |
|  | <b>Item no.:</b> 2002-435<br>Jumper; from 1 to 5; insulated; light gray              | <a href="http://www.wago.com/2002-435">www.wago.com/2002-435</a>                 |
|  | <b>Item no.:</b> 2002-436<br>Jumper; from 1 to 6; insulated; light gray              | <a href="http://www.wago.com/2002-436">www.wago.com/2002-436</a>                 |
|  | <b>Item no.:</b> 2002-437<br>Jumper; from 1 to 7; insulated; light gray              | <a href="http://www.wago.com/2002-437">www.wago.com/2002-437</a>                 |
|  | <b>Item no.:</b> 2002-438  | <a href="http://www.wago.com/2002-438">www.wago.com/2002-438</a>                 |

Subject to changes. Please also observe the further product documentation!

Jumper; from 1 to 8; insulated; light gray



**Item no.: 2002-439**

Jumper; from 1 to 9; insulated; light gray

[www.wago.com/2002-439](http://www.wago.com/2002-439)



**Item no.: 2002-440**

Jumper; from 1 to 10; insulated; light gray

[www.wago.com/2002-440](http://www.wago.com/2002-440)



**Item no.: 2002-472**

Staggered jumper; 2-way; insulated; light gray

[www.wago.com/2002-472](http://www.wago.com/2002-472)



**Item no.: 2002-473**

Staggered jumper; 3-way; insulated; light gray

[www.wago.com/2002-473](http://www.wago.com/2002-473)



**Item no.: 2002-475/011-000**

Staggered jumper; 3-way; insulated; light gray

[www.wago.com/2002-475/011-000](http://www.wago.com/2002-475/011-000)



**Item no.: 2002-475**

Staggered jumper; 5-way; insulated; light gray

[www.wago.com/2002-475](http://www.wago.com/2002-475)



**Item no.: 2002-476**

Staggered jumper; 6-way; insulated; light gray

[www.wago.com/2002-476](http://www.wago.com/2002-476)



**Item no.: 2002-474**

Staggered jumper; 4-way; insulated; light gray

[www.wago.com/2002-474](http://www.wago.com/2002-474)



**Item no.: 2002-477**

Staggered jumper; 7-way; insulated; light gray

[www.wago.com/2002-477](http://www.wago.com/2002-477)



**Item no.: 2002-473/011-000**

Staggered jumper; 2-way; from 1 to 3; insulated; light gray

[www.wago.com/2002-473/011-000](http://www.wago.com/2002-473/011-000)



**Item no.: 2002-479**

Staggered jumper; 9-way; insulated; light gray

[www.wago.com/2002-479](http://www.wago.com/2002-479)



**Item no.: 2002-478**

Staggered jumper; 8-way; insulated; light gray

[www.wago.com/2002-478](http://www.wago.com/2002-478)



**Item no.: 2002-479/011-000**

Staggered jumper; insulated; light gray

[www.wago.com/2002-479/011-000](http://www.wago.com/2002-479/011-000)

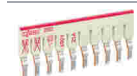

**Item no.: 2002-480**

Staggered jumper; 10-way; insulated; light gray

[www.wago.com/2002-480](http://www.wago.com/2002-480)



**Item no.: 2002-477/011-000**

Staggered jumper; insulated; light gray

[www.wago.com/2002-477/011-000](http://www.wago.com/2002-477/011-000)

Subject to changes. Please also observe the further product documentation!

WAGO GmbH & Co. KG

Hansastr. 27

32423 Minden

Phone: +49571 887-0 | Fax: +49571 887-169

Email: [info.de@wago.com](mailto:info.de@wago.com) | Web: [www.wago.com](http://www.wago.com)

Do you have any questions about our products?

We are always happy to take your call at +49 (571) 887-44222.



**Item no.: 2002-481/011-000**  
Staggered jumper; insulated; light gray

[www.wago.com/2002-481/011-000](http://www.wago.com/2002-481/011-000)



**Item no.: 2002-481**  
Staggered jumper; 11-way; insulated; light gray

[www.wago.com/2002-481](http://www.wago.com/2002-481)



**Item no.: 2002-482**  
Staggered jumper; 12-way; insulated; light gray

[www.wago.com/2002-482](http://www.wago.com/2002-482)



**Item no.: 2016-499**  
Step-down jumper; from 2016/2010 to 2010/2006/2004/2002 series; from 2216/2210 to 2210/2206 /2204/2202 series; insulated; light gray

[www.wago.com/2016-499](http://www.wago.com/2016-499)



**Item no.: 210-103**  
Wire commoning chain; insulated; black

[www.wago.com/210-103](http://www.wago.com/210-103)



**Item no.: 2002-424/000-006**  
Continuous jumper; from 1 to 4; insulated; blue

[www.wago.com/2002-424/000-006](http://www.wago.com/2002-424/000-006)

### Insulation stop

Insulation stop



**Item no.: 2002-171**  
Insulation stop; 0.25 - 0.5 mm<sup>2</sup>; 5 pieces/strip; light gray

[www.wago.com/2002-171](http://www.wago.com/2002-171)



**Item no.: 2002-172**  
Insulation stop; 0.75 - 1 mm<sup>2</sup>; 5 pieces/strip; dark gray

[www.wago.com/2002-172](http://www.wago.com/2002-172)

## Downloads

### Documentation

#### Additional Information

|                        |        |          |
|------------------------|--------|----------|
| Technical Section      | pdf    | Download |
| Technical explanations | 2.2 MB |          |

## Environmental Product Compliance

### Compliance Search

|  |     |          |
|--|-----|----------|
| Environmental Product Compliance 2202-1401/000-001   | URL | Download |
| 4-conductor through terminal block; with push-button; 2.5 mm <sup>2</sup> ; with test port; suitable for Ex e II applications; side and center marking; for DIN-rail 35 x 15 and 35 x 7.5; Push-in CAGE CLAMP®; 2,50 mm <sup>2</sup> ; green |     |          |

Subject to changes. Please also observe the further product documentation!

WAGO GmbH & Co. KG  
Hansastr. 27  
32423 Minden  
Phone: +49571 887-0 | Fax: +49571 887-169  
Email: [info.de@wago.com](mailto:info.de@wago.com) | Web: [www.wago.com](http://www.wago.com)

Do you have any questions about our products?  
We are always happy to take your call at +49 (571) 887-44222.



## Installation Notes

### Conductor termination

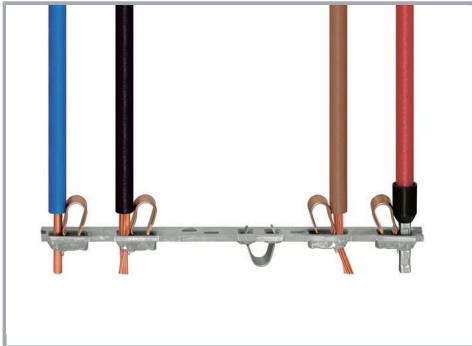

All conductor types at a glance



Push-in termination of solid and ferruled conductors



Insert fine-stranded conductors via operating tool.



Removing all conductors via operating tool.

### Commoning



Insert a push-in type jumper bar and push down until it hits the backstop.

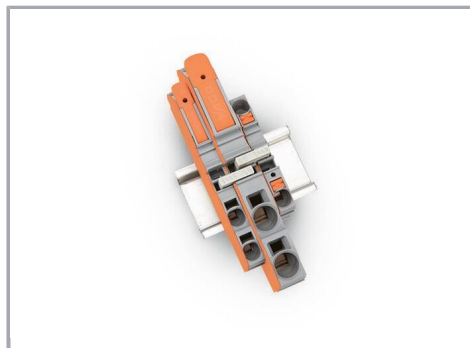

Commoning with step-down jumpers.

Subject to changes. Please also observe the further product documentation!



**Step-down jumper (2006-499)** commons 6 /4 mm<sup>2</sup> (10/12 AWG) terminal blocks (2206 /2204 Series) with 4/2.5/1.5 mm<sup>2</sup> (AWG 12/14 /16) terminal blocks (2204/2202/2201 Series).

### Testing

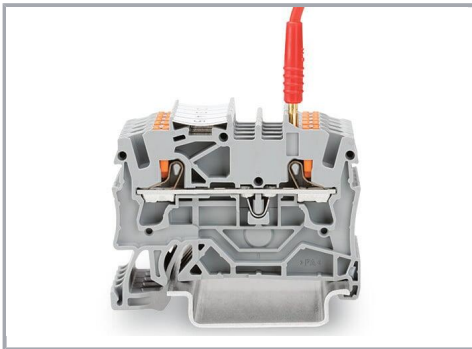

Testing with a 2 mm Ø test plug (max. 42 V).

### Marking

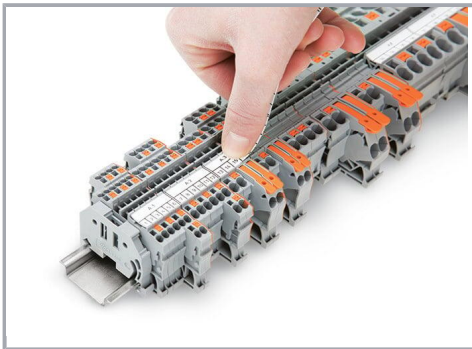

Snapping a marking strip into a marker slot.

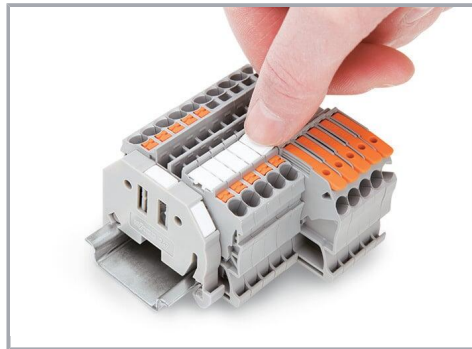

Snapping a marking strip into the marker slot.

### Product family

#### TOPJOB® S

Subject to changes. Please also observe the further product documentation!



TOPJOB® S: In various industrial applications and modern building installations, WAGO's wide and versatile range of rail-mount terminal blocks provides more than just reliable electrical connections.

[Show all products from the family](#)

Subject to changes. Please also observe the further product documentation!

---

WAGO GmbH & Co. KG  
Hansastr. 27  
32423 Minden  
Phone: +49571 887-0 | Fax: +49571 887-169  
Email: [info.de@wago.com](mailto:info.de@wago.com) | Web: [www.wago.com](http://www.wago.com)

Do you have any questions about our products?  
We are always happy to take your call at +49 (571) 887-44222.