

To: LINEAR TECHNOLOGY

Date of application
2106 05 04
 (year) (month) (day)

Approval Sheet

■ Part number : 13324-T084

■ Document attached No Yes(See Below)



* Scope and Precautions S-074-1511	*
* Heat endurance test S-074-1516	*
* Recommended reflow condition S-074-1518	*
* Packing spec. S-0074-5753	*

■ Tick the relevant box “ ” .

- New product / New specification
- New part(s) is added to approved specification
- Revision of approved specification

■ Note

This specification will be considered accepted upon receipt of your order.

Approved by _____	Sales <p style="text-align: center;">Sumida America Components Inc.</p> Approval: _____ Salesman: _____ <div style="display: flex; justify-content: space-around;"> <div style="text-align: center;">  Check: _____ </div> <div style="text-align: center;">  Design: _____ </div> </div>
-------------------	---

Customer : LINEAR TECHNOLOGY		Specification (Change History)		Type CEP1311F
Change Mark	Change Date	Request No.	Change content	Requested by

Note:					
Made: 3 r d. Ma y, 2 0 1 6		LINEAR Part Name (Customer Part Name)		1 3 3 2 4 - T 0 8 4	
Approved by	Checked by	R&D	Type code	1 3 3 2 4	
WEI SHAOHONG	ZENG YUNXIA	JIANG ZHIMING LLZ	Sample No.	1 3 3 2 4 - T 0 8 4	Spec. No. S-0227-6239 1 / 3

Specification

Type
CEP1311F

1. Scope & Precautions
Refer to S-074-1511.

2. Appearance
2-1. Dimension (mm)

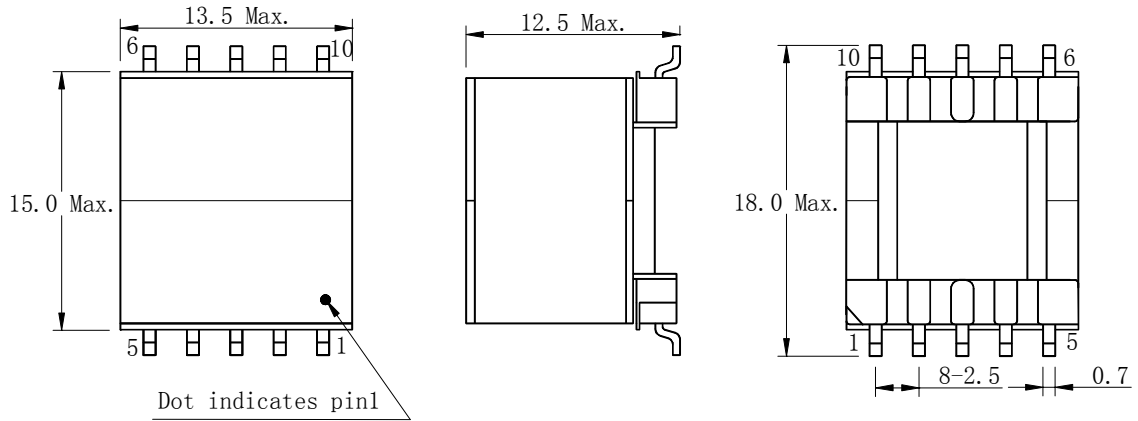

- * Dimension without tolerance is reference.
- * The dimension of terminals don't include the solder.
- * Terminal coplanarity : Max. 0.10mm.

2-2. Stamp

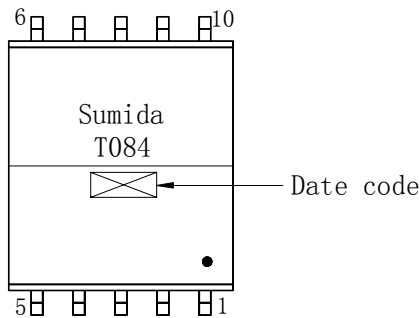

2-3. Recommended land pattern (mm)

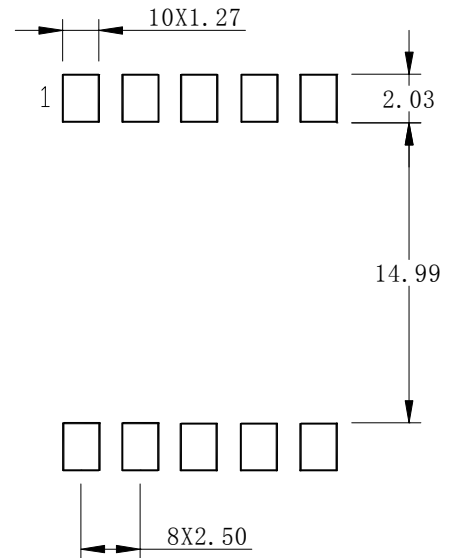

3. Coil specification
3-1. Schematic

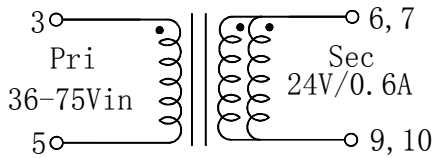

“●” Indicates the polarity.

RoHS
compliance
Cd: Max. 0.01wt%
others: Max. 0.1wt%

Note :	Spec. No. S-0227-6239 2/3
--------	---------------------------------

Specification

Type

CEP1311F

3-2. Electrical characteristics (At 25°C, unless otherwise specified).

Item	Specification	Measuring conditions
Inductance (3-5)	40 μ H \pm 10% Within	100kHz, 0.1V
Leakage inductance (3-5)	1.2 μ H Max.	100kHz, 0.1V, Tie (6+7+9+10)
DCR (3-5)	130m Ω Max.	
DCR (6, 7-9, 10)	130m Ω Max.	
Turns ratio (3-5) : (6, 7-9, 10)	1:1 \pm 3%	
Hi Pot (3, 5) - (6, 7, 9, 10)	AC 1500Vrms 2Seconds	0.5mA, 50/60Hz
Rated current (3-5)	3ADC	

* The rated current indicates the inductance will decrease to be its 85% of its original ones when the rated current is applied on it.

4. General characteristics

4-1. Storage temperature range : -40°C ~ +85°C

4-2. Operating temperature range: -40°C ~ +85°C (Including coil's temperature rise)

4-3. Resistance to reflow heat test: Refer to S-074-1516.

4-4. Recommended reflow condition : Refer to S-074-1518.

5. Packing specification

5-1. Enclosing direction of parts.

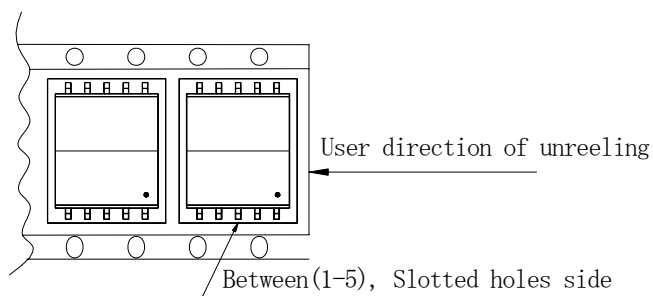

The side with stamp is upward.

5-2. Packing method refers to specification. (S-0074-5753)

Note :

Spec. No.

S-0227-6239

3/3

共用仕様書 COMMON SPECIFICATION

SUMIDA製品の適用範囲

Scope of SUMIDA products

1. 当製品は、AV機器、家電製品、OA機器、通信機器、計測機器、工作機器などの一般電子機器に使用されることを前提に製造、販売されております。

The component is manufactured and promoted to be used in general electronic of AV., home appliance, OA, communication, measurement equipments and machine tools.

2. 人命や財産に影響を与える可能性のある航空宇宙機器、医療機器、輸送機器、防災機器または同等と思われる機器に使用される場合は、必ず弊社営業部門にお問い合わせ下さい。

また、使用条件を満たさない場合や超えた場合による搭載機器に何らかの事故、損害が発生した場合でも弊社は一切その責を負いませんので、予めご了承下さい。

In the event the product is used in aerospace equipment, medical equipment, transportation equipment, disaster preventing equipment or an equivalent which may affect human health or property, please do not fail to consult with our business headquarters, branch or business office.

When the usage conditions are not satisfied or exceeded, Sumida Group shall not be liable for any trouble in, or damage to, the equipment with which the product is used.

	仕様書番号 SPEC. NO.
--	-----------------

S-074-1511

1/2

<h1>共用仕様書</h1> <h2>COMMON SPECIFICATION</h2>
--

コイル使用上の共通注意事項 Precautions of coil use

1. 製品は高温、多湿、塵埃、腐食性ガスの無い環境で保管して下さい。
Products should not be kept in unsuitable storage conditions such as areas susceptible to high temperatures, high humidity, dust or corrosion.
2. 製品の落下や乱雑な取り扱い、バラ積みは、破損の恐れがありますので注意して下さい。
Always handle our products with care.
3. 手脂によりはんだ付け性が劣化しますので、端子に直接手を触れないで下さい。
Don't touch electrodes directly with bare hands as oil secretions may inhibit soldering.
Always ensure optimum conditions for soldering.
4. 端子への過度なストレスは断線の原因になりますので、端子は折り曲げないで下さい。
Don't bend the terminals or subject them to excessive stress.
5. 端子及びケースのラグ部は、全てプリント基板にはんだ付けをして下さい。
Please ensure that all terminals and case lugs are completely fixed with solder onto PCB.
6. 調整コアがはんだ付けフラックスにより固定されないよう、生産工程に注意して下さい。
Ensure the tuning slug or cap is not fixed by solder flux during your production process.
7. コイルの洗浄はしないで下さい。もし、洗浄が必要な場合は連絡下さい。
Refrain from rinsing coils. If it is necessary, please consult with our company.
8. プリント基板設計の際は、コイルは端面部への配置を避けて下さい。
Avoid placing coils near the edge of the PCB.
9. 面実装コイルは自動実装を基準に設計されていますので、手はんだの場合は取り扱いに注意して下さい。
Our SMT coils are designed for automatic mounting. Please be careful if soldering by hand.
10. コイルを自動実装される場合は、巻線露出部分への接触を避けて下さい。また、端子をガイドとして使用しないで下さい。
Don't touch any exposed winding part and avoid coming into contact with the guide of electrode in automatic mounting.
11. 当納入仕様書は、部品単体での品質を規定するものです。ご使用に際しては、御社製品に実装された状態で必ず評価、ご確認をお願い致します。
This specification limits the quality of the component as a single unit.
Please insure the component is thoroughly evaluated in your application circuit.
12. 高電圧を発生させるインバータトランスでは、導体はトランスから2mm以上離す設計をして下さい。
When using our high voltage inverter transformers, please place 2mm away from electric conductor.
13. 結露する環境での使用はお避けください。
Please do not use this component in a place where dew condenses .
14. 密閉状態の環境で使用する場合は温度変化により結露する恐れがありますので注意をお願いします。
Since dew condensation may be caused by temperature change, please pay special attention when using this component in a sealed condition.

	仕様書番号 SPEC. NO.
--	-----------------

S - 0 7 4 - 1 5 1 1

2/2

リフロー耐熱 HEAT ENDURANCE

リフロー耐熱試験条件 HEAT ENDURANCE TEST

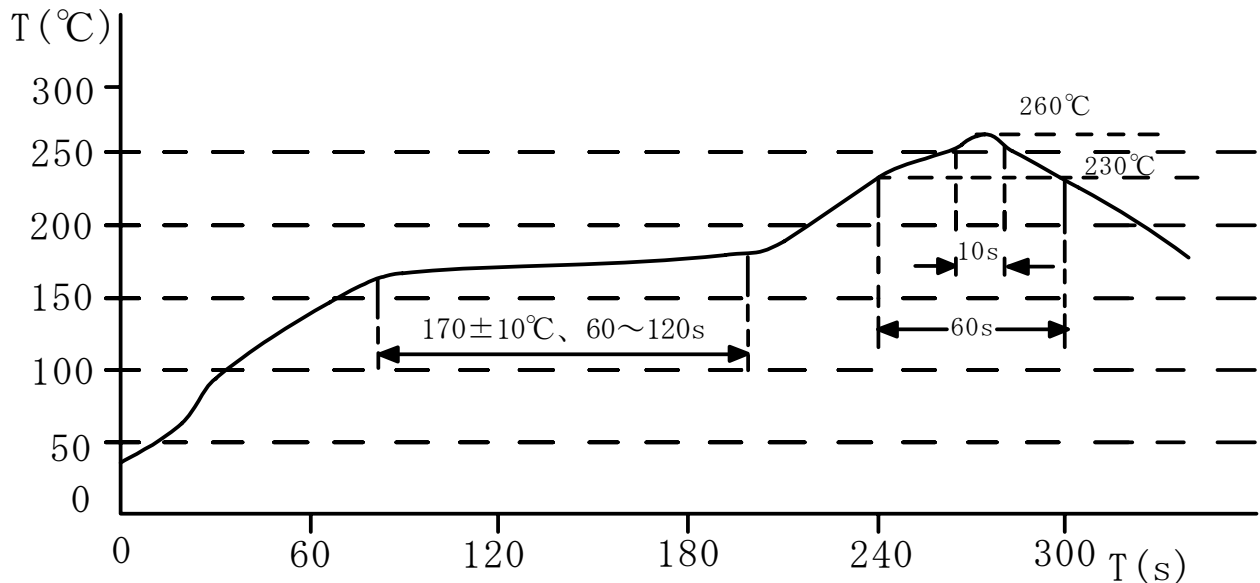

- * 上記の様なチャートの試験をし、常温常湿中に2時間放置後測定し、電氣的、機構的異常のないこと。
THE TEST SHOULD BE MADE UNDER THE CONDITIONS ACCORDING TO THE CHART, AFTER THE TEST IT IS KEPT FOR 2 HOURS UNDER THE NORMAL TEMPERATURE AND HUMIDITY. THEN, NO MECHANICAL AND ELECTRICAL DEFECT SHOULD BE FOUND OUT.
- * 2回リフロー可とする。(但し、1回目と2回目の間隔は常温常湿中に1時間以上放置後とする。)
THE REFLOW TEST CAN BE DONE TWICE, BUT THE INTERVAL SHOULD BE MORE THAN ONE HOUR UNDER THE NORMAL CONDITIONS.
- * リフロー耐熱試験条件は、弊社に於て使用しております装置によるものです。
THE REFLOW TEST CONDITIONS ARE BASED ON THE TESTING INSTRUMENTS AVAILABLE IN SUMIDA.

鉛フリーはんだ用
FOR LEAD FREE SOLDERING

仕様書番号 SPEC. NO.

S-074-1516

1 / 1

共用仕様書
COMMON SPECIFICATION

推奨リフロー条件（温度チャート）

THE RECOMMENDED REFLOW CONDITION (TEMPERATURE CHART)

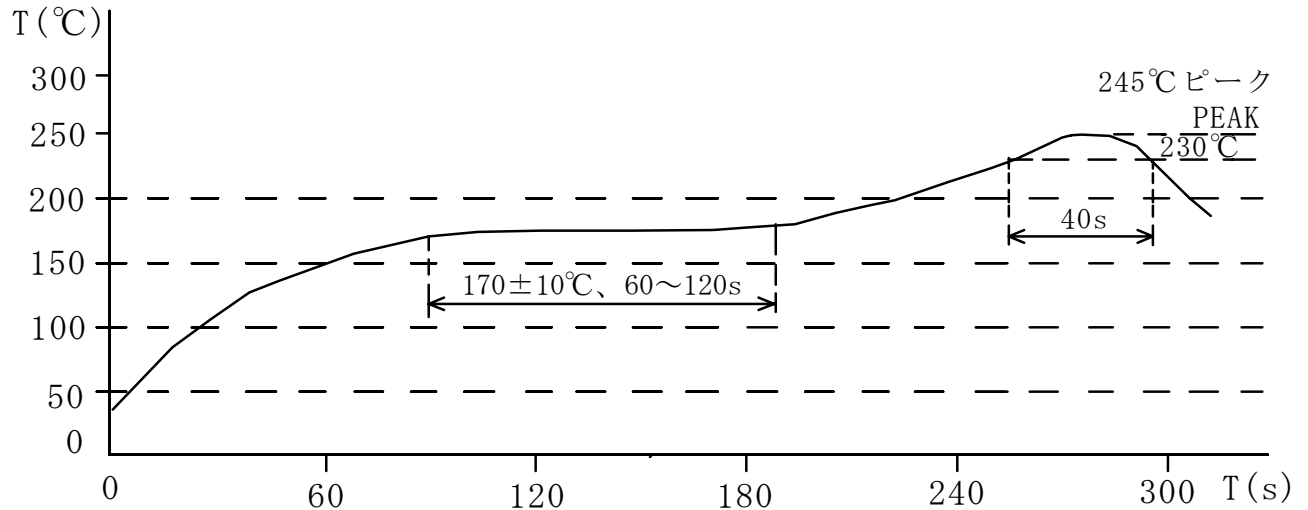

- * 上記推奨リフロー条件は、弊社に於いて使用しておりますリフロー装置に依るものです。付きましては、はんだ付け性は装置の種類、リフローの条件、方法等により大きく異なる場合がありますので、リフロー条件の設定に付きましては、十分な確認の上設定願います。

THE REFLOW CONDITION RECOMMENDED ABOVE IS ACCORDING TO THE MACHINE USED BY OUR COMPANY. BIG DIFFERENCES WILL ARISE AS A RESULT OF THE TYPE OF MACHINE, REFLOW CONDITIONS, METHOD, ETC USED. HENCE, BEFORE SETTING UP YOUR REFLOW CONDITIONS, PLEASE CONFIRM WITH THE ABOVE.

- * 尚、不明な点がございましたら事前にお問い合わせ下さい。

MOREOVER, PLEASE CLEAR ALL DOUBTS WITH OUR COMPANY BEFORE STARTING.

鉛フリーはんだ用
FOR LEAD FREE SOLDERING

仕様書番号 SPEC. NO.

S-074-1518

1 / 1

R e v i s i o n s

S y m b o l	D a t e	N o.	R e v i s i o n s	C l i e n t
-------------	---------	------	-------------------	-------------

Note:				
Made: 2 4 t h. A p r., 2 0 1 3			Part No.	
Chk.	Chk.	Drg.	SUMIDA Code	
YU WEIWEN	WEI YANCHUN	JIANG YANMIN CXC	Sample No.	Spec. No. S-0074-5753 1/6
			First Issue	

Carrier tape packing specification (Be in conformity with IEC 60286-3)

1. Application of this specification

- 1) Applies to SUMIDA ELECTRIC CO.,LTD. carrier tape packing.
- 2) For items not listed in this specification , reference to be made to the specification of the individual part.

2. Application(Types) : CEP 1311F, CEP 1311

3. Taping specification

- 1) Reel dimensions·····Figure 1
- 2) Tape dimensions·····Figure 2
- 3) Tape direction·····Figure 3

4. Taping

- 1) The carrier tape and shield tape is wound in one continuous reel without any connected portions. Should any piece of coil be missing from the carrier tape, a "CROSS(X)" slit would be made on the shield of the cartridge and a coil replaced. After which, cellophane tape is used to reseal the cartridge.
- 2) The angle between the seal tape during peel off and the direction of unreeling shall be 165° to 180° .The seal tape shall adhere uniformly to the carrier tape along both sides in the direction of unreeling .The peel force with a peel speed of 300mm/min±10mm/min shall be as follows:
0.1N to 1.3N for a tape width.

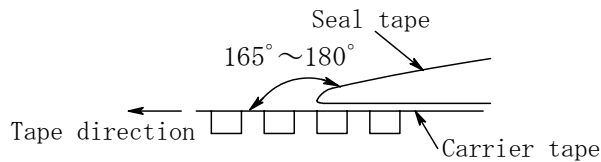

- 3) Precaution : completed reels with radius less than 40mm will result in the following.
 - (I)Cracks on the carrier tape
 - (II)Shield tape tearing off

5. Packing

- 1) Position of coils in the carrier tape : refer to the specification of the individual part.
- 2) There should not be :
 - (I)Wrong position of goods in the carrier tape
 - (II)Rejected goods in the carrier tape
 - (III)Missing goods from the carrier tape
- 3) One reel consists of 200pcs of coil.
- 4) On the completed end of the reel, the carrier tape is fixed with a driving tape.

Note :

Spec. No.

S-0074-5753

2/6

6. Indication

1) The following will be indicated on one side of the reel :

Customer part no.] Bar-code label used
Quantity	
Lot no.	
Supplier	
Supplier specification no.	
Supplier type name	

2) Position of indication : unfixed the position

Leftside from
Leading edge

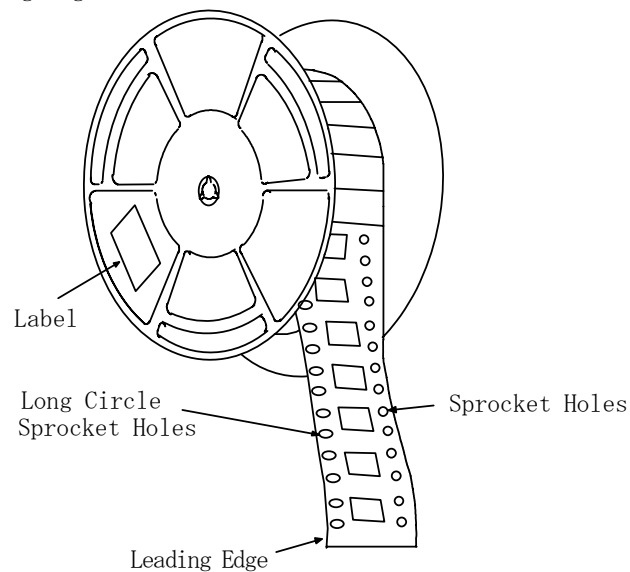

7. Handling precaution

The surface of the product cannot withstand a weight/force exceeding 10N.

8. Storage period of packed product

The storage period of the packed product is within 6 months after the production. The storage environment is that there are no caustic factors and no dew condensation, surrounding temperature is 5~40°C and relative humidity is 20~70%. Reel should be rewound in case of longtime storage.

9. Others

Unit of measure used when placing orders : 1 reel(200pcs).

Note :

Spec. No.

S - 0 0 7 4 - 5 7 5 3

3 / 6

Figure 1 reel dimension (unit: mm)

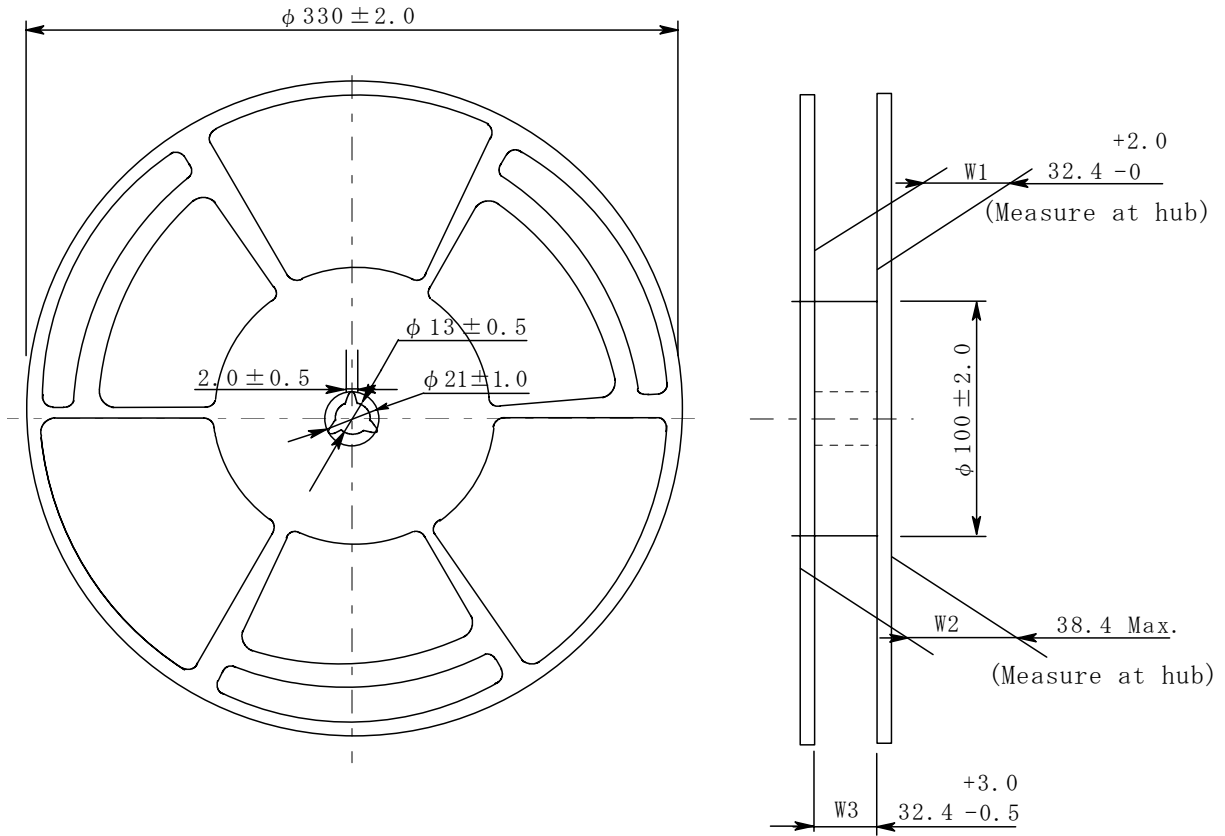

- * The dimensions of W1, W2 and W3 are in conformity with EIA 481C.
- * Dimension without tolerance is approx.

	Material
Reel section	PS
HUB section	

Note :

Spec. No.

S-0074-5753

4/6

Figure 2 tape dimension (unit:mm)

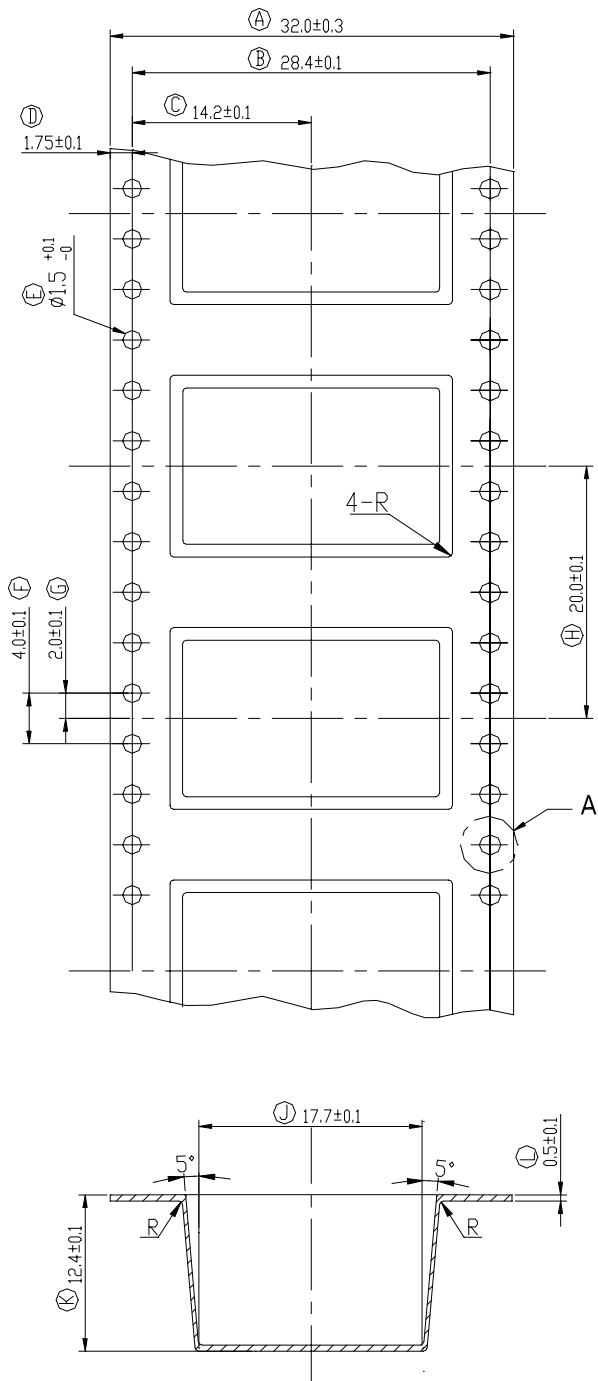

Head	Material, Standard
Carrier tape Material	Polystyrene
Seal tape material	Polyester
Seal tape thickness	0.1 Max.
Sprocket Hole pitches	40±0.2/10 pitch

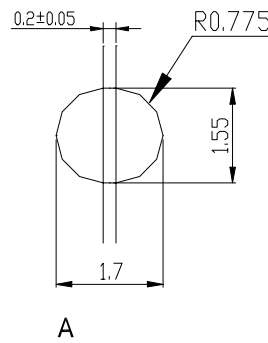
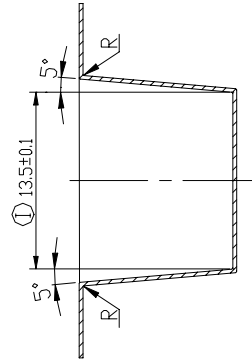

* Dimensions without tolerance are approx.

Note :

Spec. No.

S-0074-5753

5 / 6

Figure 3 tape direction, leader, trailer section dimension

Leader section	Min. 400 mm
Carrier tape start size	Min. 100 mm
Trailer section size	Min. 160 mm
Quantity	200pcs

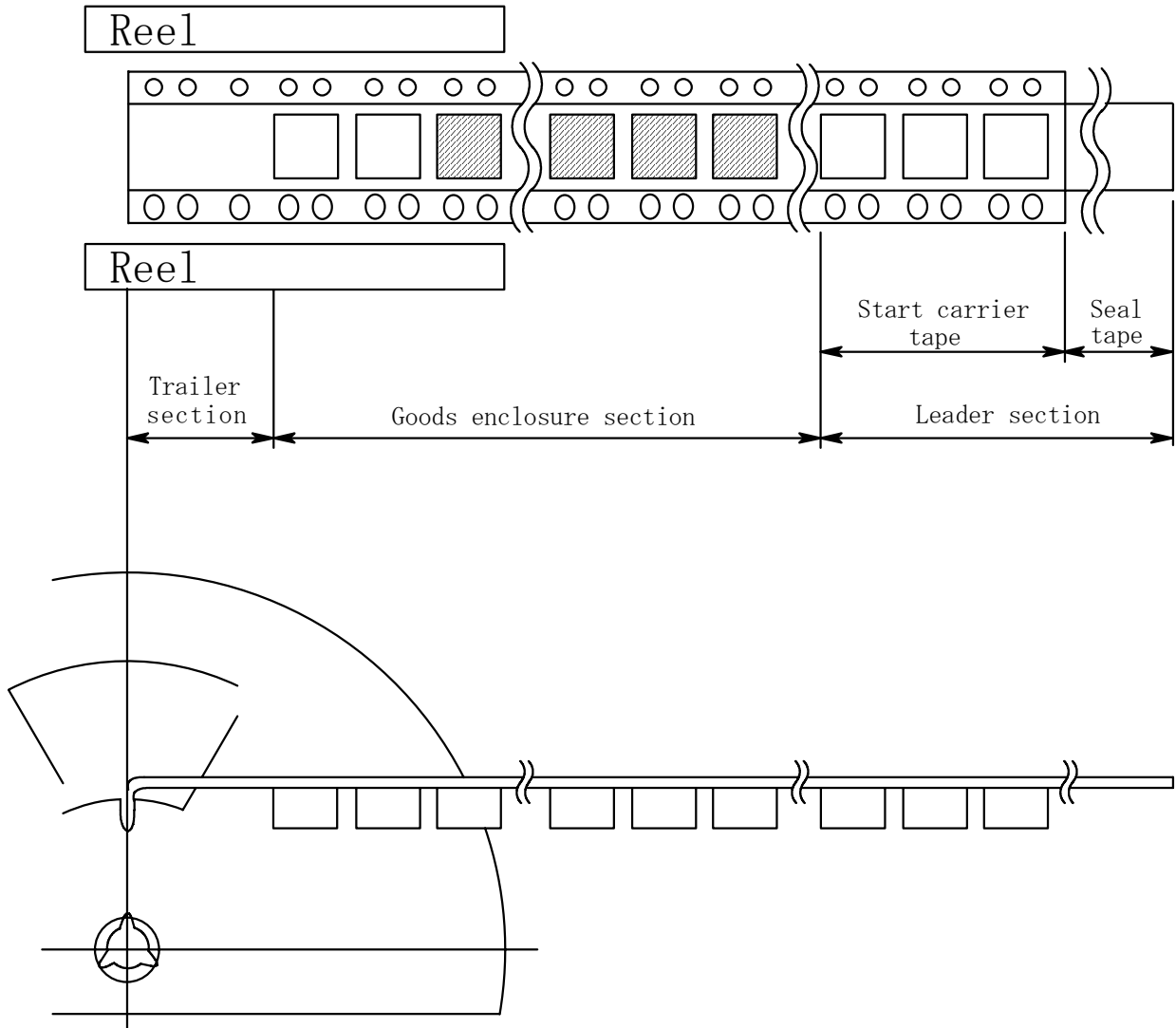

Note :

Spec. No.

S-0074-5753

6/6