

# Aluminum Electrolytic Capacitors

## SMD (Chip), High Temperature, Low Impedance High Vibration Capability

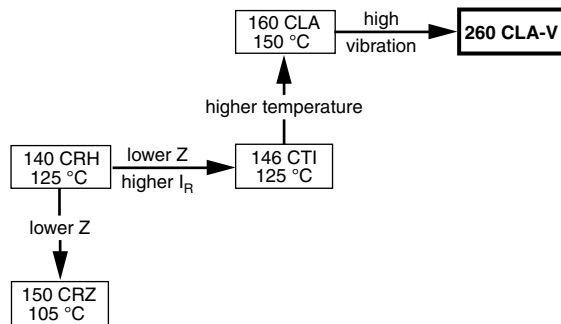

Fig. 1

QUICK REFERENCE DATA	
DESCRIPTION	VALUE
Nominal case sizes (L x W x H in mm)	16 x 16 x 16 to 18 x 18 x 21
Rated capacitance range, $C_R$	150 $\mu$ F to 3300 $\mu$ F
Tolerance on $C_R$	$\pm 20$ %
Rated voltage range, $U_R$	16 V to 80 V
Category temperature range	-55 °C to +150 °C
Endurance test at 150 °C	1000 h to 1500 h
Useful life at 150 °C	1500 h to 2000 h
Useful life at 40 °C 1.8 x $I_R$ applied	300 000 h to 400 000 h
Shelf life at 0 V, 150 °C	1000 h
Based on sectional specification	IEC 60384-18 / CECC 32300
Climatic category IEC 60068	55 / 150 / 56

### FEATURES

- Useful life: up to 2000 h at 150 °C
- High reliability
- Low ESR
- Polarized aluminum electrolytic capacitors, non-solid electrolyte, self healing
- SMD-version with base plate, lead (Pb)-free reflow solderable
- Charge and discharge proof, no peak current limitation
- High temperature reflow soldering according to JEDEC® J-STD-020
- High temperature proof
- Vibration proof, 6-pin version up to 30 g
- AEC-Q200 qualified
- Material categorization: for definitions of compliance please see [www.vishay.com/doc?99912](http://www.vishay.com/doc?99912)

 AUTOMOTIVE  
GRADE

**RoHS**  
COMPLIANT

### APPLICATIONS

- SMD technology, for high temperature reflow soldering
- High temperature environment, high peak load
- Automotive, industrial
- Smoothing, filtering, buffering

### MARKING

- Rated capacitance (in  $\mu$ F)
- Rated voltage (in V)
- Date code, in accordance with IEC 60062
- Black mark or “-” sign indicating the cathode (the anode is identified by beveled edges)
- Code indicating group number (A)

### PACKAGING

Supplied in blister tape on reel

<b>SELECTION CHART FOR <math>C_R</math>, <math>U_R</math>, AND RELEVANT NOMINAL CASE SIZES (L x W x H in mm)</b>						
$C_R$ ( $\mu F$ )	$U_R$ (V)					
	16	25	35	50	63	80
150	→	→	→	→	→	16 x 16 x 16
220	→	→	→	→	16 x 16 x 16	18 x 18 x 16
330	→	→	→	16 x 16 x 16	18 x 18 x 16	18 x 18 x 21
470	→	→	16 x 16 x 16	18 x 18 x 16	16 x 16 x 21	-
680	→	16 x 16 x 16	18 x 18 x 16	16 x 16 x 21	18 x 18 x 21	-
1000	16 x 16 x 16	18 x 18 x 16	16 x 16 x 21	18 x 18 x 21	-	-
1500	18 x 18 x 16	16 x 16 x 21	18 x 18 x 21	-	-	-
2200	16 x 16 x 21	18 x 18 x 21	-	-	-	-
2700	18 x 18 x 21	-	-	-	-	-
3300	18 x 18 x 21	-	-	-	-	-

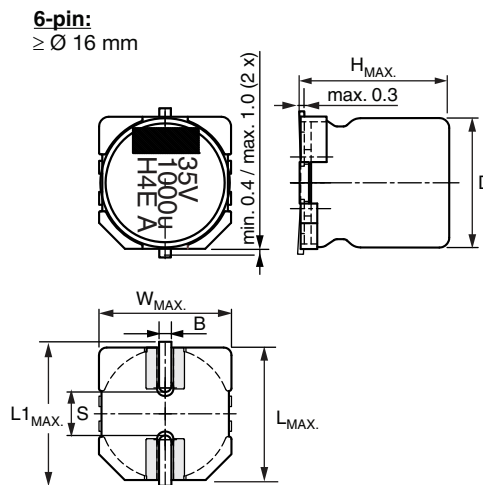

Fig. 2 - Dimensional outline

Table 1

<b>DIMENSIONS in millimeters AND MASS</b>									
NOMINAL CASE SIZE L x W x H	CASE CODE	$L_{MAX.}$	$W_{MAX.}$	$H_{MAX.}$	$\varnothing D$	$B_{MAX.}$	S	$L1_{MAX.}$	MASS (g)
16 x 16 x 16	1616	16.6	16.6	17.5	16.0	1.3	6.5	18.6	≈ 5.8
16 x 16 x 21	1621	16.6	16.6	22.0	16.0	1.3	6.5	18.6	≈ 7.1
18 x 18 x 16	1816	19.0	19.0	17.5	18.0	1.3	6.5	21.0	≈ 8.0
18 x 18 x 21	1821	19.0	19.0	22.0	18.0	1.3	6.5	21.0	≈ 9.3

**Table 2**

<b>TAPE AND REEL DIMENSIONS</b> in millimeters, <b>PACKAGING QUANTITIES</b>						
NOMINAL CASE SIZE L x W x H	CASE CODE	PITCH P <sub>1</sub>	TAPE WIDTH W	TAPE THICKNESS T <sub>2</sub>	REEL DIAMETER	PACKAGING QUANTITY PER REEL
16 x 16 x 16	1616	28	44	18.9	380	150
16 x 16 x 21	1621	28	44	23.4	380	100
18 x 18 x 16	1816	32	44	18.9	380	125
18 x 18 x 21	1821	32	44	23.4	380	100

**Note**

- Detailed tape dimensions see section "PACKAGING"

**MOUNTING**

The capacitors are designed for automatic placement on to printed-circuit boards.

Optimum dimensions of soldering pads depend amongst others on soldering method, mounting accuracy, print layout and / or adjacent components.

For recommended soldering pad dimensions, refer to Fig. 3 and Table 3.

**SOLDERING**

Soldering conditions are defined by the curve, temperature versus time, where the temperature is that measured on the component during processing.

For maximum conditions refer to Fig. 4.

Any temperature versus time curve which does not exceed the specified maximum curves may be applied.

As a general principle, temperature and duration shall be the **minimum** necessary required to ensure good soldering connections. However, the specified maximum curves should never be exceeded.

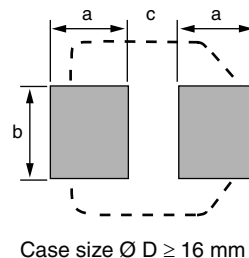

Fig. 3 - Recommended soldering pad dimensions

**Table 3**

<b>RECOMMENDED SOLDERING PAD DIMENSIONS</b> in millimeters			
CASE CODE	a	b	c
1616	7.8	9.6	4.7
1621	7.8	9.6	4.7
1816	8.8	9.6	4.7
1821	8.8	9.6	4.7

**ADVANCED SOLDERING PROFILE FOR LEAD (Pb)-FREE REFLOW PROCESS  
ACCORDING TO JEDEC J-STD-020**

Fig. 4 - Maximum temperature load during reflow soldering

**Table 4**

<b>REFLOW SOLDERING CONDITIONS</b> for MAL226099xxxE3	
<b>PROFILE FEATURES</b>	<b>CASE CODE 1616 TO 1821</b>
Maximum time from 25 °C to T <sub>Peak</sub>	300 s
Maximum ramp-up rate to 150 °C	3 K/s
Maximum time from 150 °C to 200 °C (t <sub>1</sub> )	150 s
Maximum time from 190 °C to 200 °C (t <sub>2</sub> )	110 s
Ramp up rate from 200 °C to T <sub>Peak</sub>	0.5 K/s to 3 K/s
Maximum time above T <sub>Liquidus</sub> (217 °C) (t <sub>3</sub> )	90 s
Maximum time above 230 °C (t <sub>4</sub> )	60 s
Peak temperature T <sub>Peak</sub>	245 °C
Maximum time above T <sub>Peak</sub> minus 5 °C	30 s
Ramp-down rate from T <sub>Liquidus</sub>	3 K/s to 6 K/s

**Notes**

- Temperature measuring point on top of the case and on terminals.
- Maximum 2 runs with pause of minimum 30 min in between.



ELECTRICAL DATA	
SYMBOL	DESCRIPTION
$C_R$	Rated capacitance at 100 Hz, tolerance $\pm 20\%$
$I_R$	Rated RMS ripple current at 100 kHz, 150 °C
$I_{L2}$	Maximum leakage current after 2 min at $U_R$
$\tan \delta$	Maximum dissipation factor at 100 Hz
Z	Maximum impedance at 100 kHz

**Note**

- Unless otherwise specified, all electrical values in Table 5 apply at  $T_{amb} = 20\text{ °C}$ ,  $P = 86\text{ kPa}$  to  $106\text{ kPa}$ ,  $RH = 45\%$  to  $75\%$

**ORDERING EXAMPLE**

Electrolytic capacitor 260 CLA-V series

330  $\mu\text{F}$  / 50 V;  $\pm 20\%$ 

Nominal case size: 16 mm x 16 mm x 16 mm; taped on reel

Ordering code: MAL226099104E3

Table 5

ELECTRICAL DATA AND ORDERING INFORMATION									
$U_R$ (V)	$C_R$ ( $\mu\text{F}$ )	NOMINAL CASE SIZE L x W x H (mm)	$I_R$ 150 °C 100 kHz (mA)	$I_{L2}$ 2 min ( $\mu\text{A}$ )	$\tan \delta$ 100 Hz	Z 100 kHz 20 °C ( $\Omega$ )	Z 100 kHz -40 °C ( $\Omega$ )	LIFE CODE <sup>(1)</sup>	ORDERING CODE MAL2260...
16	1000	16 x 16 x 16	850	160	0.16	0.050	0.45	L1	99503E3
	1500	18 x 18 x 16	900	240	0.16	0.050	0.45	L1	99504E3
	2200	16 x 16 x 21	1100	352	0.18	0.035	0.32	L3	99505E3
	2700	18 x 18 x 21	1350	432	0.18	0.035	0.32	L3	99506E3
	3300	18 x 18 x 21	1400	528	0.20	0.035	0.32	L3	99507E3
25	680	16 x 16 x 16	800	170	0.14	0.050	0.45	L1	99603E3
	1000	18 x 18 x 16	830	250	0.14	0.050	0.45	L1	99604E3
	1500	16 x 16 x 21	1050	375	0.14	0.035	0.32	L3	99605E3
	2200	18 x 18 x 21	1350	550	0.16	0.035	0.32	L3	99606E3
35	470	16 x 16 x 16	800	165	0.12	0.050	0.45	L1	99003E3
	680	18 x 18 x 16	830	238	0.12	0.050	0.45	L1	99004E3
	1000	16 x 16 x 21	1000	350	0.12	0.035	0.32	L3	99005E3
	1500	18 x 18 x 21	1350	525	0.12	0.035	0.32	L3	99006E3
50	330	16 x 16 x 16	700	165	0.10	0.072	0.65	L1	99104E3
	470	18 x 18 x 16	720	235	0.10	0.070	0.63	L1	99105E3
	680	16 x 16 x 21	800	340	0.10	0.052	0.47	L3	99106E3
	1000	18 x 18 x 21	1100	500	0.10	0.049	0.44	L3	99107E3
63	220	16 x 16 x 16	500	139	0.10	0.100	0.90	L1	99805E3
	330	18 x 18 x 16	520	208	0.10	0.095	0.86	L1	99806E3
	470	16 x 16 x 21	600	296	0.10	0.075	0.68	L3	99807E3
	680	18 x 18 x 21	700	428	0.10	0.072	0.65	L3	99808E3
80	150	16 x 16 x 16	430	120	0.12	0.390	3.12	L1	99703E3
	220	18 x 18 x 16	430	176	0.12	0.390	3.12	L1	99704E3
	330	18 x 18 x 21	520	264	0.12	0.300	2.40	L2	99705E3

**Note**

- <sup>(1)</sup> Determines the applicable row in the table “Endurance Test Duration and Useful Life”

**Table 6**

EXTENDED VIBRATION SPECIFICATIONS		
PARAMETER	PROCEDURE	REQUIREMENTS
Vibration improvement	From 10 g to 30 g	No visible damage; no leakage of electrolyte; marking legible $\Delta C/C: \pm 5\%$ with respect to initial measurements
Vibration frequency range	10 Hz to 2 kHz	
Vibration profile	<ul style="list-style-type: none"> <li>• Constant sinus sweep (1 oct./min.)</li> <li>• 3 directions</li> <li>• 8 h per direction</li> </ul>	

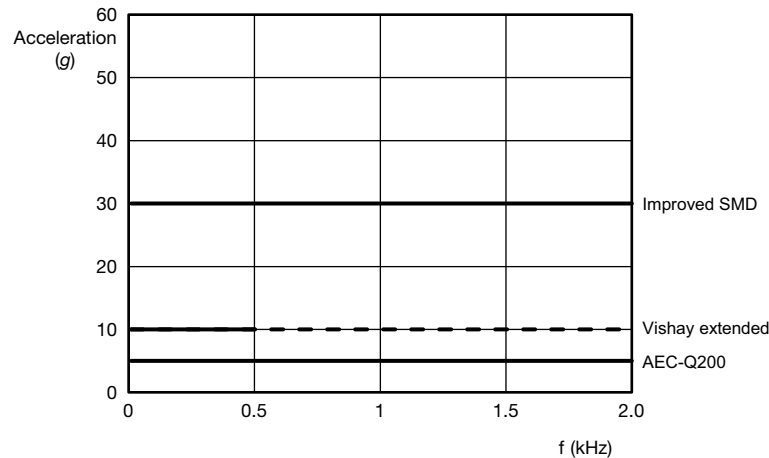

Fig. 5 - Vibration profile

**Table 7**

ADDITIONAL ELECTRICAL DATA		
PARAMETER	CONDITIONS	VALUE
<b>Voltage</b>		
Surge voltage for short periods	IEC 60384-18, subclause 4.14	$U_s \leq 1.15 \times U_R$
Reverse voltage for short periods	IEC 60384-18, subclause 4.16; $T_A \leq 150^\circ\text{C}$	$U_{rev} \leq 1\text{ V}$
<b>Current</b>		
Leakage current	After 2 min at $U_R$	$I_{L2} \leq 0.01 \times C_R \times U_R$
<b>Inductance</b>		
Equivalent series inductance (ESL)	$\varnothing D \geq 16\text{ mm}$	Typ. 11 nH
<b>Resistance</b>		
Equivalent series resistance (ESR) at 100 Hz	Calculated from $\tan \delta_{max}$ and $C_R$ (see Table 5)	$ESR = \tan \delta / 2\pi f C_R$

**CAPACITANCE (C)**

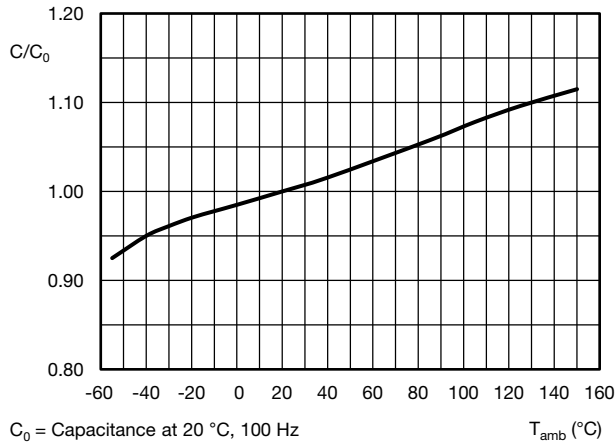

Fig. 6 - Typical multiplier of capacitance as a function of ambient temperature

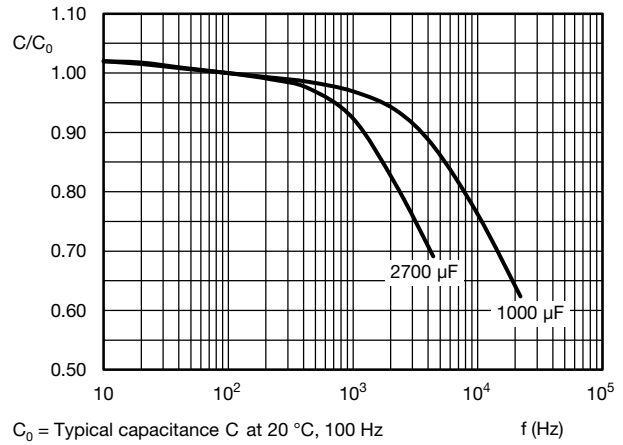

Fig. 7 - Typical multiplier of capacitance as a function of frequency

**DISSIPATION FACTOR (tan  $\delta$ )**

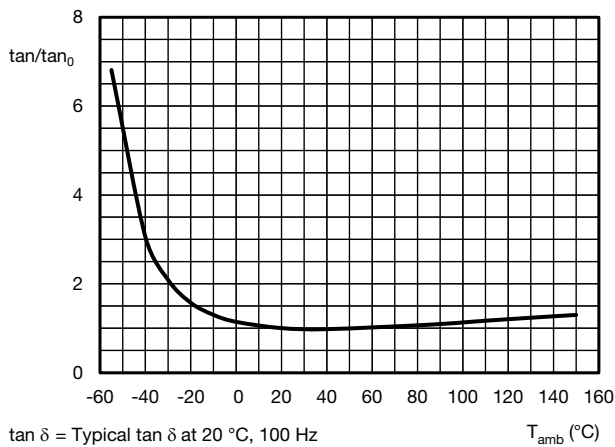

Fig. 8 - Typical multiplier of dissipation factor ( $\tan \delta$ ) as a function of ambient temperature

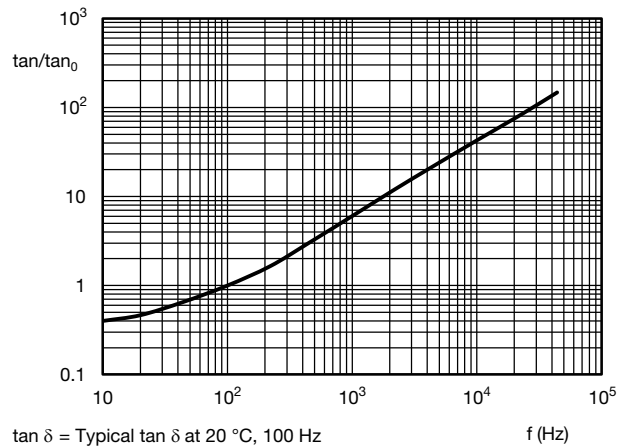

Fig. 9 - Typical multiplier of dissipation factor ( $\tan \delta$ ) as a function of frequency

**EQUIVALENT SERIES RESISTANCE (ESR)**

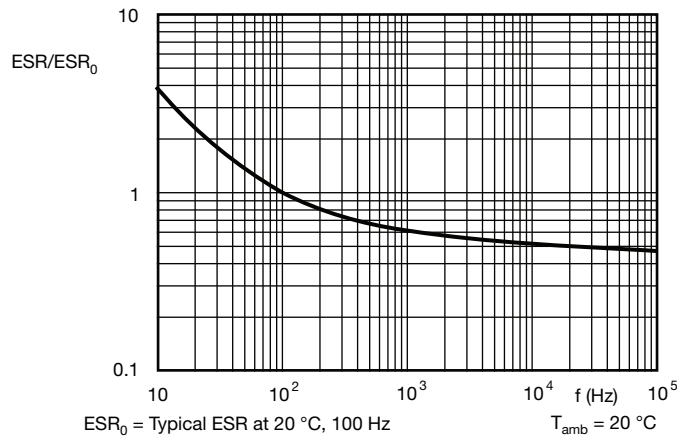

Fig. 10 - Typical multiplier of ESR as a function of frequency

**IMPEDANCE (Z)**

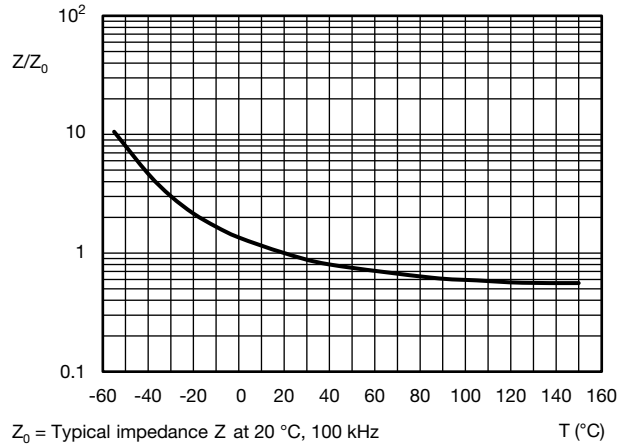

Fig. 11 - Typical multiplier of impedance as a function of temperature

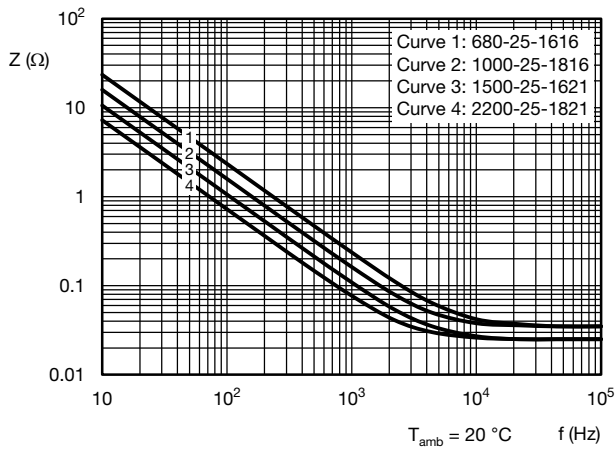

Fig. 12 - Typical impedance as a function of frequency

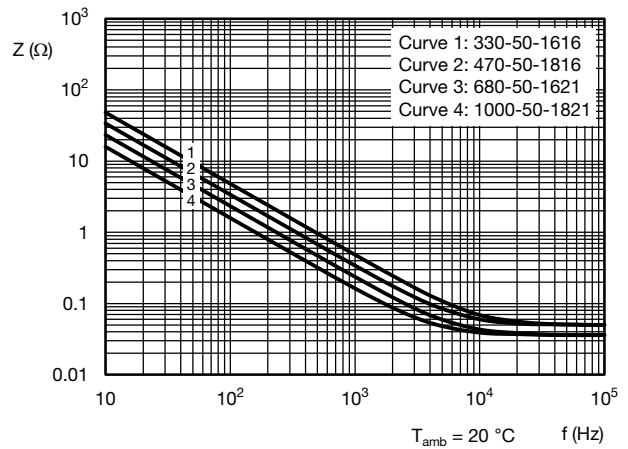

Fig. 13 - Typical impedance as a function of frequency

**RIPPLE CURRENT AND USEFUL LIFE**

Table 8

ENDURANCE TEST DURATION AND USEFUL LIFE			
LIFE CODE	ENDURANCE AT 150 °C (h)	USEFUL LIFE AT 150 °C (h)	USEFUL LIFE AT 40 °C 1.8 x I <sub>R</sub> APPLIED (h)
L1	1000	1500	350 000
L2	1500	1500	350 000
L3	1500	2000	400 000

**Note**

- Multiplier of useful life code: MBC245



MBC245

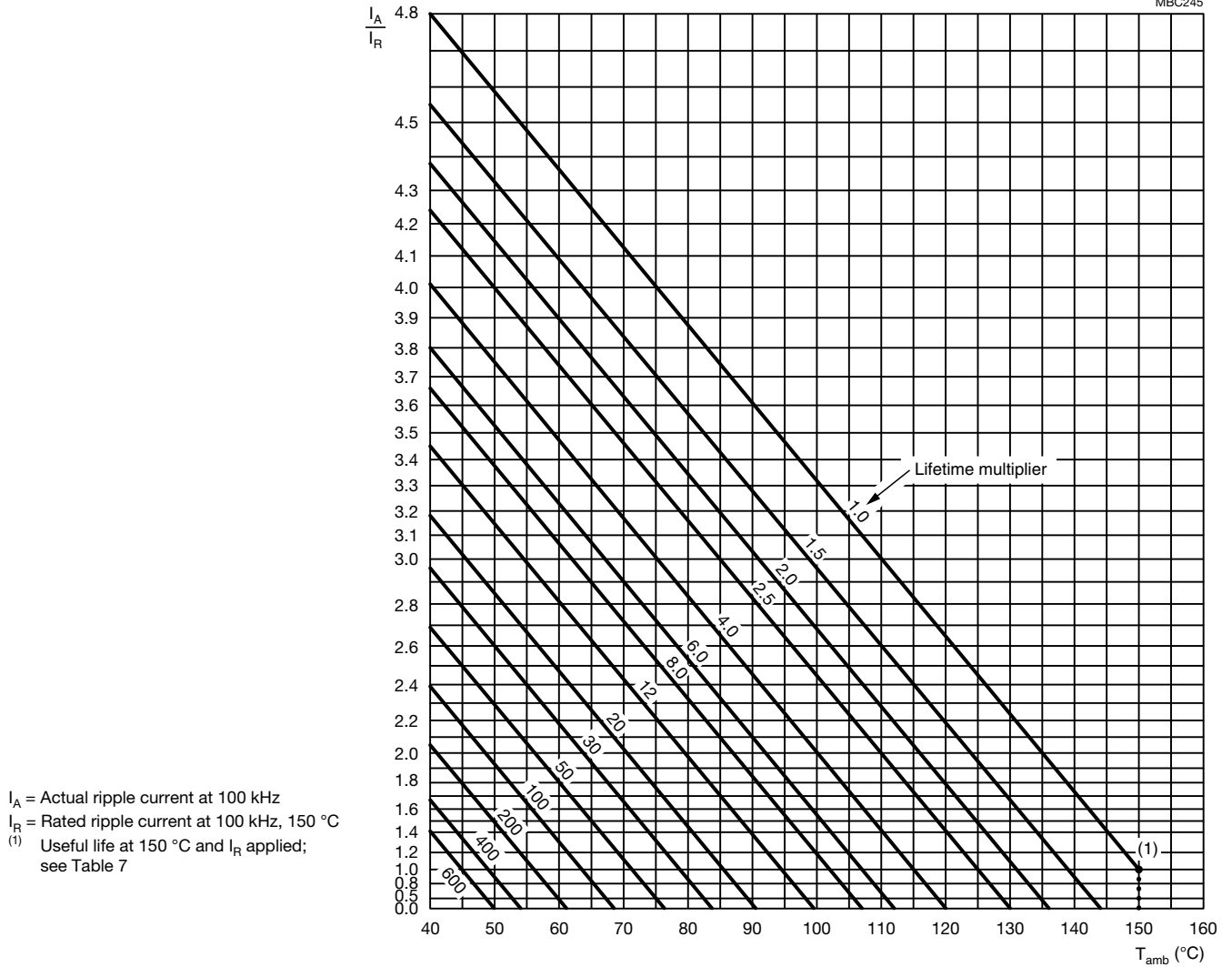

Fig. 14 - Multiplier of useful life as a function of ambient temperature and ripple current load

Table 9

MULTIPLIER OF RIPPLE CURRENT ( $I_R$ ) AS A FUNCTION OF FREQUENCY							
FREQUENCY (Hz)							
50	100	300	1000	3000	10 000	30 000	100 000
$I_R$ MULTIPLIER							
0.40	0.60	0.75	0.80	0.90	0.95	0.97	1.00



Table 10

TEST PROCEDURES AND REQUIREMENTS			
TEST		PROCEDURE (quick reference)	REQUIREMENTS
NAME OF TEST	REFERENCE		
Mounting	IEC 60384-18, subclause 4.3	Shall be performed prior to tests mentioned below; reflow soldering; for maximum temperature load refer to chapter "Mounting"	$\Delta C/C: \pm 5 \%$ $\tan \delta \leq \text{spec. limit}$ $I_{L2} \leq \text{spec. limit}$
Endurance	IEC 60384-18 / CECC 32300, subclause 4.15	$T_{\text{amb}} = 150 \text{ }^\circ\text{C}$ ; $U_R$ applied; for test duration see Table 7	$\Delta C/C: \pm 20 \%$ $\tan \delta \leq 2 \times \text{spec. limit}$ $I_{L2} \leq \text{spec. limit}$
Useful life	CECC 30301, subclause 1.8.1	$T_{\text{amb}} = 150 \text{ }^\circ\text{C}$ ; $U_R$ and $I_R$ applied; for test duration see Table 7	$\Delta C/C: \pm 30 \%$ $\tan \delta \leq 3 \times \text{spec. limit}$ $I_{L2} \leq \text{spec. limit}$ no short or open circuit total failure percentage: $\leq 1 \%$
Shelf life (storage at high temperature)	IEC 60384-18 / CECC 32300, subclause 4.17	$T_{\text{amb}} = 150 \text{ }^\circ\text{C}$ ; no voltage applied; 1000 h After test: $U_R$ to be applied for 30 min, 24 h to 48 h before measurement	For requirements see "Endurance test" above
Reverse voltage	IEC 60384-18 / CECC 32300, subclause 4.16	$T_{\text{amb}} = 150 \text{ }^\circ\text{C}$ : 125 h at $U = -0.5 \text{ V}$ , followed by 125 h at $U_R$	$\Delta C/C: \pm 15 \%$ $\tan \delta \leq 1.5 \times \text{spec. limit}$ $I_{L2} \leq \text{spec. limit}$

Statements about product lifetime are based on calculations and internal testing. They should only be interpreted as estimations. Also due to external factors, the lifetime in the field application may deviate from the calculated lifetime. In general, nothing stated herein shall be construed as a guarantee of durability.



## Disclaimer

ALL PRODUCT, PRODUCT SPECIFICATIONS AND DATA ARE SUBJECT TO CHANGE WITHOUT NOTICE TO IMPROVE RELIABILITY, FUNCTION OR DESIGN OR OTHERWISE.

Vishay Intertechnology, Inc., its affiliates, agents, and employees, and all persons acting on its or their behalf (collectively, "Vishay"), disclaim any and all liability for any errors, inaccuracies or incompleteness contained in any datasheet or in any other disclosure relating to any product.

Vishay makes no warranty, representation or guarantee regarding the suitability of the products for any particular purpose or the continuing production of any product. To the maximum extent permitted by applicable law, Vishay disclaims (i) any and all liability arising out of the application or use of any product, (ii) any and all liability, including without limitation special, consequential or incidental damages, and (iii) any and all implied warranties, including warranties of fitness for particular purpose, non-infringement and merchantability.

Statements regarding the suitability of products for certain types of applications are based on Vishay's knowledge of typical requirements that are often placed on Vishay products in generic applications. Such statements are not binding statements about the suitability of products for a particular application. It is the customer's responsibility to validate that a particular product with the properties described in the product specification is suitable for use in a particular application. Parameters provided in datasheets and / or specifications may vary in different applications and performance may vary over time. All operating parameters, including typical parameters, must be validated for each customer application by the customer's technical experts. Product specifications do not expand or otherwise modify Vishay's terms and conditions of purchase, including but not limited to the warranty expressed therein.

Hyperlinks included in this datasheet may direct users to third-party websites. These links are provided as a convenience and for informational purposes only. Inclusion of these hyperlinks does not constitute an endorsement or an approval by Vishay of any of the products, services or opinions of the corporation, organization or individual associated with the third-party website. Vishay disclaims any and all liability and bears no responsibility for the accuracy, legality or content of the third-party website or for that of subsequent links.

Except as expressly indicated in writing, Vishay products are not designed for use in medical, life-saving, or life-sustaining applications or for any other application in which the failure of the Vishay product could result in personal injury or death. Customers using or selling Vishay products not expressly indicated for use in such applications do so at their own risk. Please contact authorized Vishay personnel to obtain written terms and conditions regarding products designed for such applications.

No license, express or implied, by estoppel or otherwise, to any intellectual property rights is granted by this document or by any conduct of Vishay. Product names and markings noted herein may be trademarks of their respective owners.