

CUSTOMER PRINT

PART NUMBER: 8382-XPG-3XX

NOTES:  
 1. ALL PARTS TO BE BULK PACKED.  
 2. ALL DIMENSIONS ARE REFERENCE EXCEPT THOSE WITH A TOLERANCE.

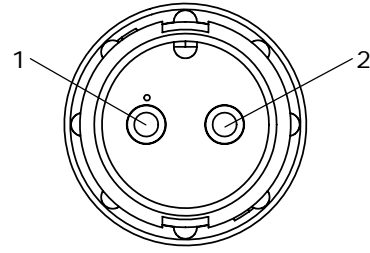

**FACE VIEW**  
8382-2PG-3XX

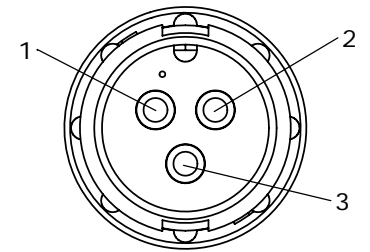

**FACE VIEW**  
8382-3PG-3XX

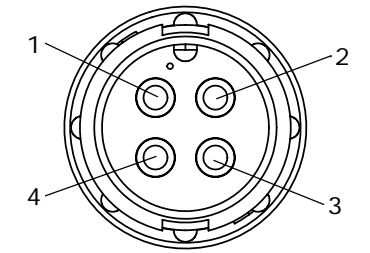

**FACE VIEW**  
8382-4PG-3XX

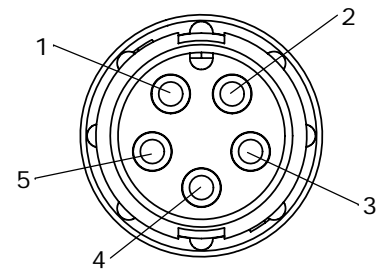

**FACE VIEW**  
8382-5PG-3XX

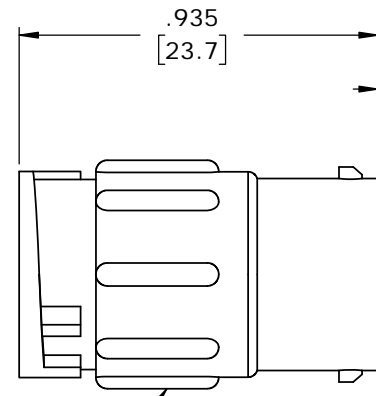

CABLE CONNECTOR, MALE  
MAT'L: NYLON, BLACK

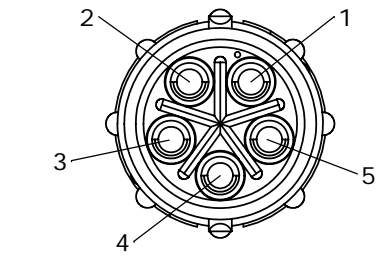

**WIRE VIEW**  
8382-5PG-3XX

DAISY CHAIN GROMMET FOR 8382-XPG-3DC  
MAT'L: RUBBER, BLACK

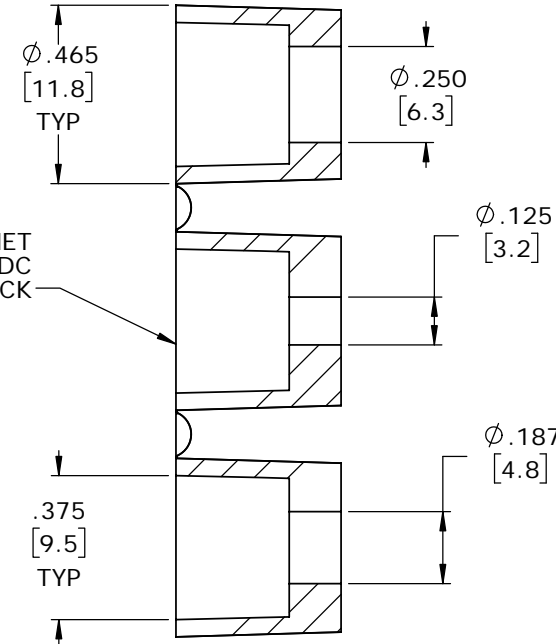

SINGLE GROMMET  
 8382-XPG-311 .125 I.D. FOR CABLE .09-.14 O.D. [2.3-3.6]  
 8382-XPG-315 .188 I.D. FOR CABLE .15-.17 O.D. [3.8-4.3]  
 8382-XPG-318 .156 I.D. FOR CABLE .18-.20 O.D. [4.6-5.1]  
 8382-XPG-321 .225 I.D. FOR CABLE .21-.23 O.D. [5.3-5.8]

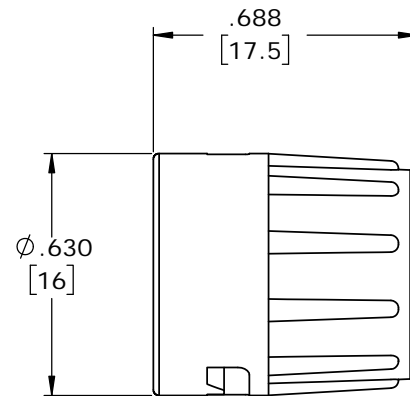

BACKSHELL  
MAT'L: NYLON, BLACK

ASS'Y P/N	GROMMET SIZE
8382-XPG-3DC	DAISY CHAIN
8382-XPG-311	CABLE O.D. .09-0.14 [2.3-3.6]
8382-XPG-315	CABLE O.D. .15-.17 [3.8-4.3]
8382-XPG-318	CABLE O.D. .18-.20 [4.6-5.1]
8382-XPG-321	CABLE O.D. .21-.23 [5.3-5.8]

KIT P/N	NO. OF CONTACTS
8382-2PG-3XX	2
8283-3PG-3XX	3
8283-4PG-3XX	4
8283-5PG-3XX	5
8283-XPG-3XX	

GROMMET SIZE FOR SINGLE GROMMET OR "DC" FOR DAISY CHAIN

NO. OF CONTACTS

**CUSTOMER APPROVAL**

THIS DOCUMENT CONTAINS CONFIDENTIAL INFORMATION PROPRIETARY TO CONXALL CORPORATION. ANY REPRODUCTION, DISCLOSURE, OR USE OF THIS DOCUMENT /INFORMATION IS EXPRESSLY PROHIBITED UNLESS AUTHORIZED IN WRITING BY CONXALL CORPORATION.

APPROVED BY: \_\_\_\_\_  
 DATE: \_\_\_\_\_

DIMENSIONS IN BRACKETS [ ] ARE METRIC

**RoHS COMPLIANT**

A	MA	02-12-18	DRAWING CREATED PER DOR 15-E253SL #20	
REV.	INIT.	DATE	DESCRIPTION	
	MA	02-12-18	ORIG. DRAWN BY: _____ DATE: 02-12-18 CHECKED BY: _____  601 E. WILDWOOD VILLA PARK, IL 60181 TITLE: CONNECTOR ASSEMBLY (2-5) #16 PIN CONTACTS MINI-CON-X STANDARD PRODUCT CUSTOMER: STANDARD PRODUCT	
ALL INFORMATION ILLUSTRATED IS THE PROPERTY OF "CONXALL CORPORATION". UNAUTHORIZED DUPLICATION OR DISTRIBUTION OF THIS DOCUMENT IS PROHIBITED. ALL UNITS ARE IN FEET, INCHES, FRACTION OF INCHES AND DECIMALS.			APPROVED BY:	
SCALE	SIZE	SHEET		
NTS	B	1 OF 1		
FILE:	DIRECTORY:	PART NUMBER:	REV	
8382-XPG-3XX	SLW	8382-XPG-3XX	A	