

## General Description

The DS2484 evaluation system (EV system) consists of a DS2484 evaluation kit (EV kit) and a DS9400 USB-to-I<sup>2</sup>C adapter. The DS2484 is an I<sup>2</sup>C-to-1-Wire<sup>®</sup> bridge device that performs protocol conversion from an I<sup>2</sup>C master to any attached 1-Wire slave devices. Relative to any attached 1-Wire slave device, the DS2484 is a 1-Wire master. The evaluation software runs under a Windows<sup>®</sup> 7, Windows 8, or Windows XP<sup>®</sup> operating system (OS), providing a handy user interface to exercise the features of the DS2484.

Order the DS2484EVKIT# for the complete EV system to evaluate the DS2484 using a PC. Evaluation software for the EV system is also available on our website at: [www.maximintegrated.com/evkit](http://www.maximintegrated.com/evkit).

## Features

- I<sup>2</sup>C Host Interface Supports 100kHz and 400kHz
- I<sup>2</sup>C Communication Speeds
- I<sup>2</sup>C Operating Voltages: 1.8V ±5% and 3.3V ±5%
- 1-Wire Operating Voltage: 1.8V ±5% and 3.3V ±5%
- EV Kit Contains a Mounted 6-Pin SOT23 DS2484R+T IC
- Convenient On-Board Test Points and TO-92 Socket
- Standard RJ11 Connector Interfaces to DS9120 Socket Boards
- Downloadable Evaluation Software

*Ordering Information appears at end of data sheet.*

## EV System Contents

QTY	DESCRIPTION
1	DS2484 Evaluation Board
1	DS9400 USB-to-I <sup>2</sup> C Adapter Maxim DS9400#

QTY	DESCRIPTION
1	USB Type A to USB-Mini Type B Cable Qualtek 3021003-03
1	1024-Bit 1-Wire EEPROM (3 TO-92) Maxim DS2431+

## DS2484 Evaluation Kit Board

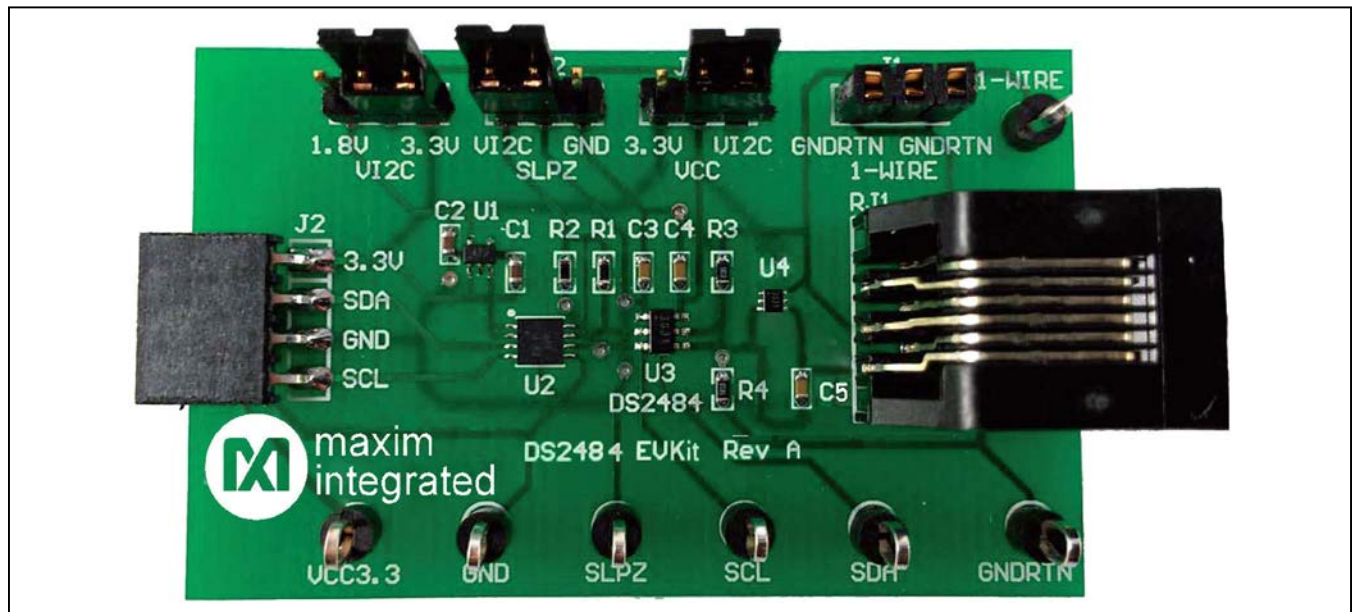

Windows and Windows XP are registered trademarks and registered service marks of Microsoft Corporation.

1-Wire is a registered trademark of Maxim Integrated Products, Inc.



## DS2484 Evaluation System

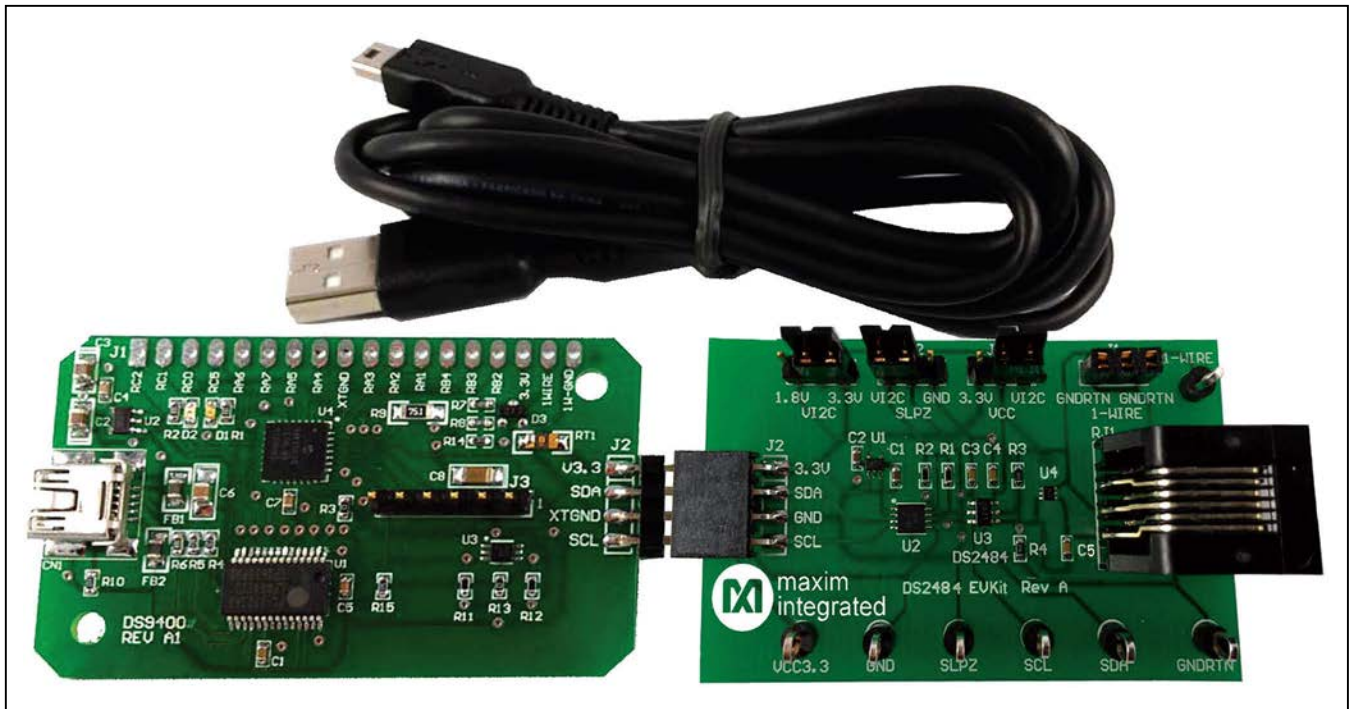

### Quick Start

#### Recommended Equipment

- Maxim DS9400 EV kit (included)
- DS2484 EV kit (included)
- USB type A to USB-Mini type B cable (included)
- DS2431+ (included)
- PC with a Windows 7, Windows 8, Windows Vista®, or Windows XP OS and a spare USB port

**Note:** In the following sections, software-related items are identified by bolding. Text in **bold** refers to items directly from the EV kit software. Text in **bold and underlined** refers to items from the Windows OS.

#### Procedure

- 1) a) Do the following to install PL-2303 Prolific Driver:
  - Download the driver file called **PL2303\_Prolific\_DriverInstaller\_1\_9\_0.ZIP** or newer from <http://prolificusa.com/pl-2303hx-drivers>.
  - Open** and **Run** the file with the name or newer version **PL2303\_Prolific\_DriverInstaller\_v1417.EXE**.

*Windows Vista is a registered trademark and registered service mark of Microsoft Corp.*

- b) Follow the directions of the **Install Wizard** until **Finish** is reached of the PL-2303 USB-to-serial driver install. Close by clicking the **Finish** button.
- 2) The DS9400 USB-to-I<sup>2</sup>C adapter uses both the Prolific PL-2303HXD and a microcontroller to provide an I<sup>2</sup>C port on any computer. Verify correct installation of the virtual COM port by inserting the DS9400 into a spare USB port on the computer. Check the COM port by looking in **Control Panel|System|Device Manager** and expand **Ports (COM & LPT)**. If the driver installed correctly, the driver should display as in the example shown in [Figure 1](#). Note that your COM port number may be different.
  - You have now completed the installation of the DS9400 adapter.
- 3) Proceed now by setting up the DS2484 EV kit hardware by doing the following:
  - a) Set the jumpers per [Figure 16](#) for 3.3V operation for both the I<sup>2</sup>C I/F and 1-Wire.
  - b) Insert the DS2431 device into J1 of the DS2484 EV kit.

- c) Plug the J2 of the DS9400 adapter into J2 of the DS2484 EV kit.
- 4) Now download the **DS2484 EVKit Software** from [www.maximintegrated.com/evkit](http://www.maximintegrated.com/evkit).
- 5) Unzip the **DS2484 EVKIT.ZIP** in a known location.
- 6) Open the **DS2484 EVKIT** folder and double-click the **Setup.EXE**. If you encounter the dialog box shown in

- 7) The DS2484 EV kit software detects if the PC has the required .NET Framework 2.0 files. If the files do not exist, the program prompts to download them from the web. Otherwise, the program will install and display the **DS2484 EVKIT** main page (Figure 4).

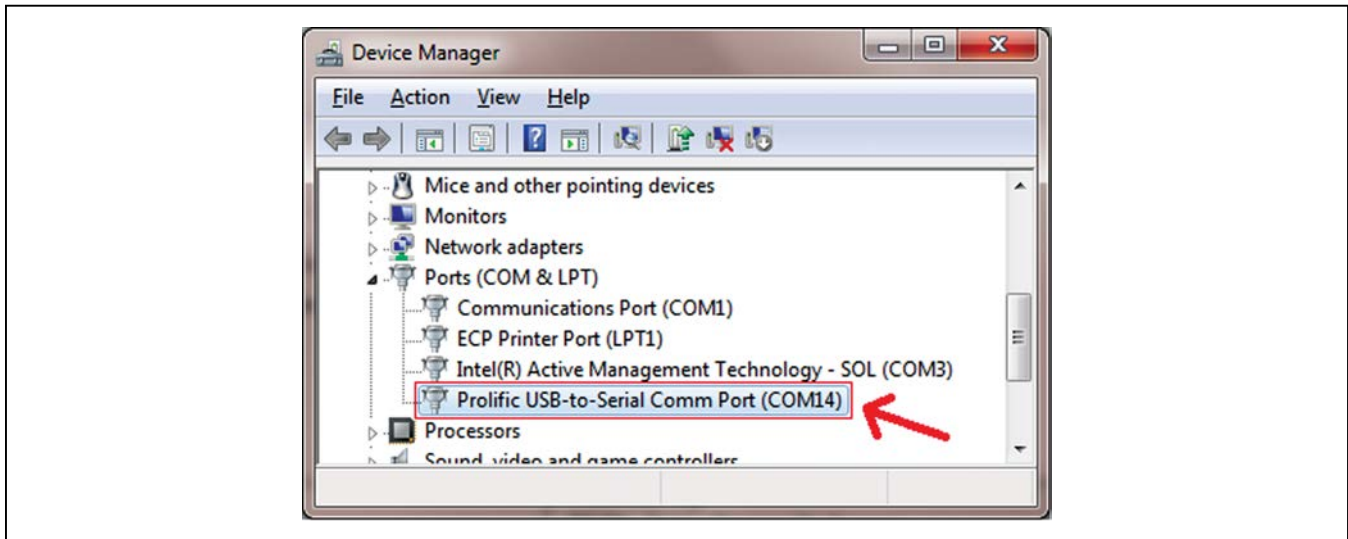

Figure 1. DS9400 COM Port

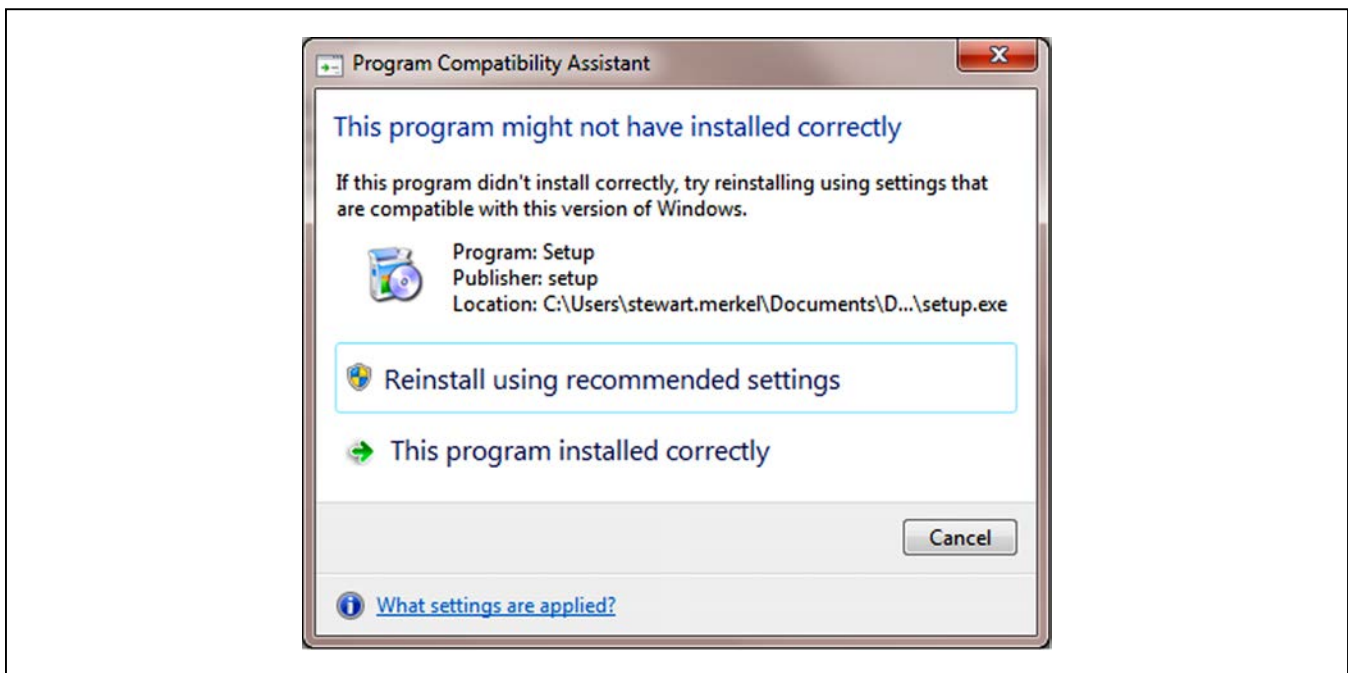

Figure 2. Program Compatibility Assistant

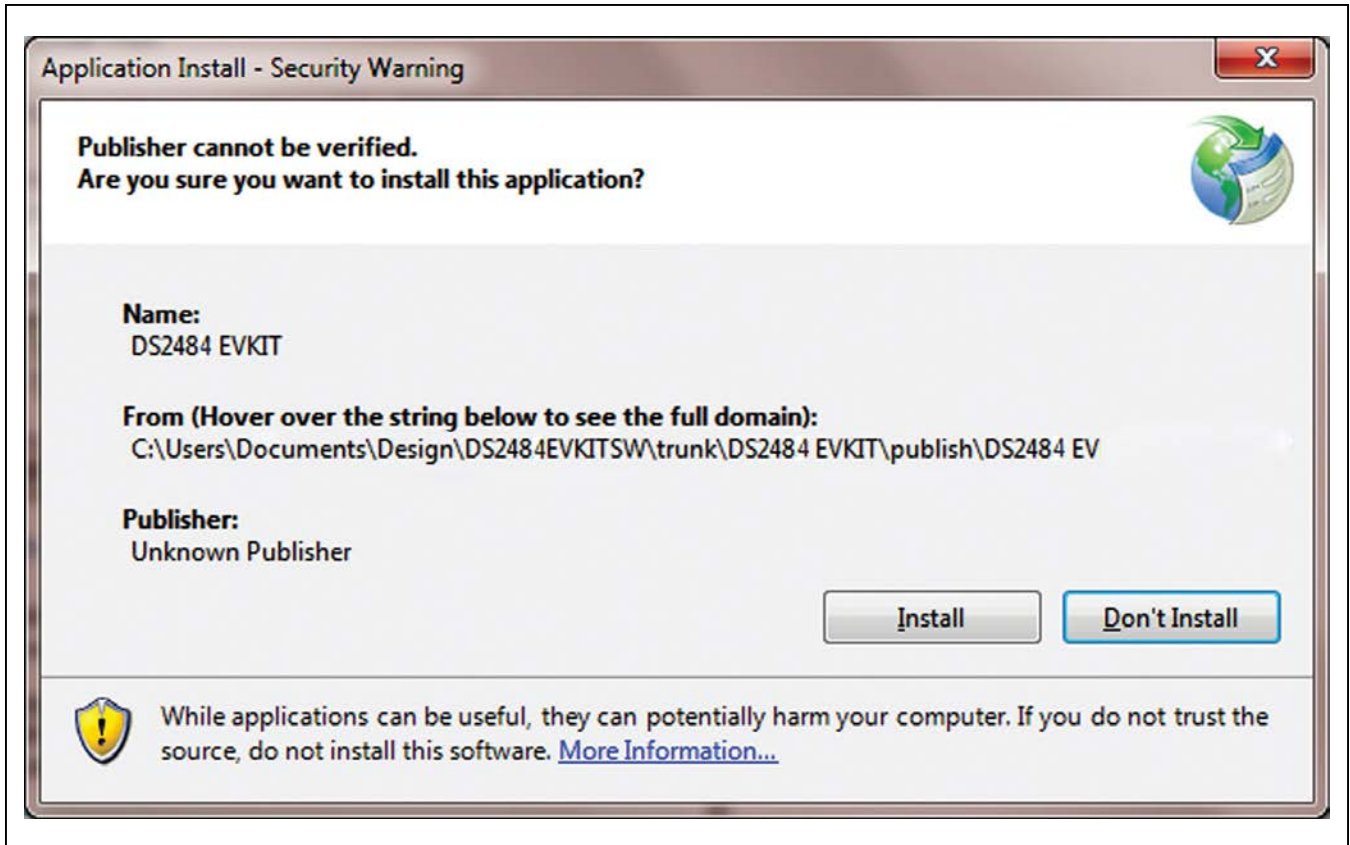

Figure 3. Application Install – Security Warning



### Detailed Description of Software

Figure 4 shows the evaluation software’s main window. This window consists of three main tabs: **DS2484**, **1-Wire Sequences**, and **Error Log**. The **I2C Data Log** and the **1-Wire Data Log** group boxes are shown regardless of which tab is selected and display communication activity.

These two group boxes assist the engineer in becoming familiar with what command sequences the DS2484 device needs in order to function. A mini tool bar provides additional functionality for both the software and the DS2484 device.

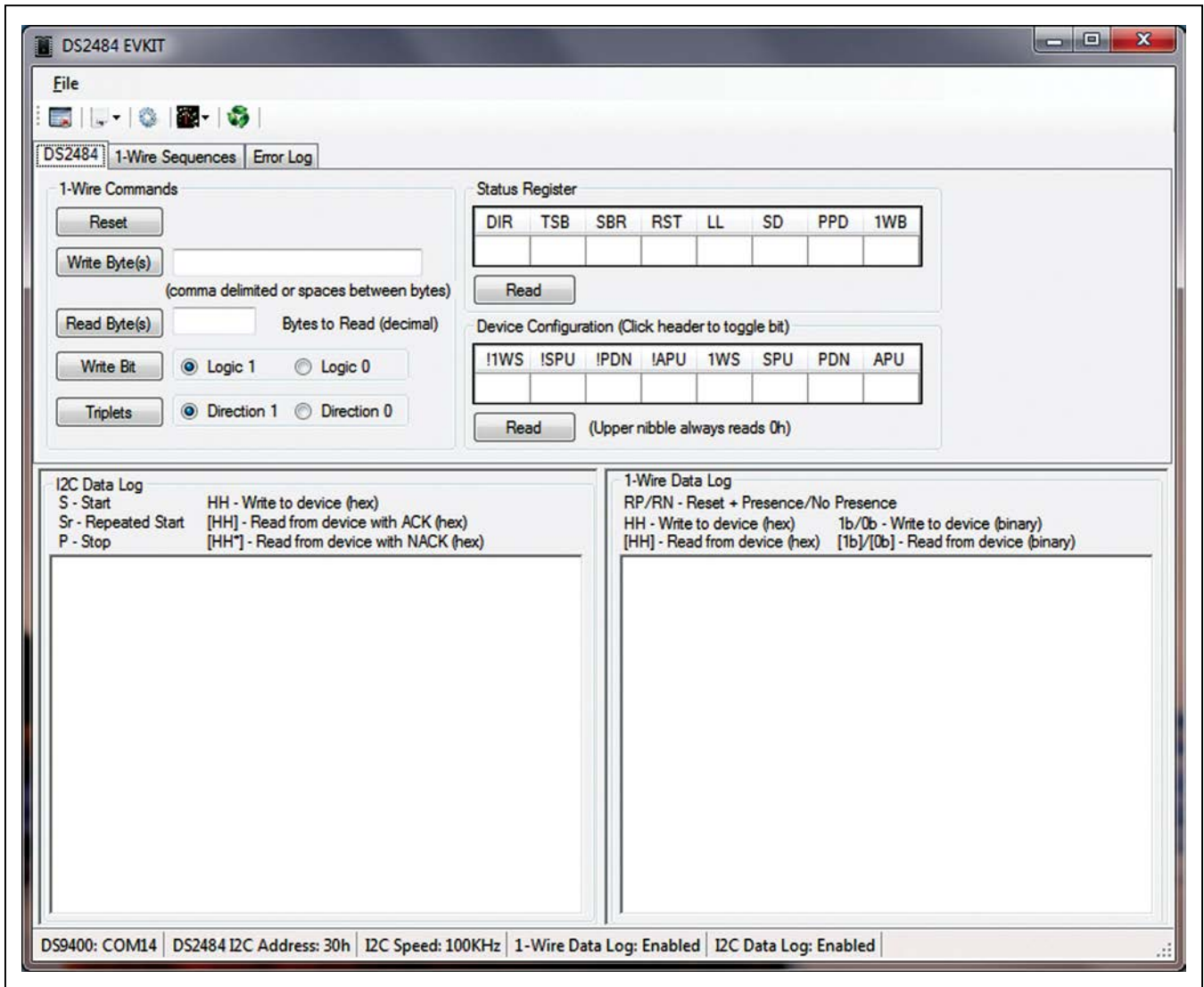

Figure 4. DS2484 EVKIT Main Window

**Viewer Window Areas**

**DS2484 Tab**

The **1-Wire Commands** group box (Figure 5) allows the user to send **1-Wire commands** to any 1-Wire slave device. The following features are supported in the **1-Wire Commands** group box:

- **Reset:** This sends a 1-Wire Reset command on the 1-Wire bus.
- **Write Byte(s):** Writes any number of 1-Wire bytes on the 1-Wire bus up to 16,382 bytes (no spaces or commas).

- **Read Byte(s):** Reads any number of 1-Wire time-slot bytes on the 1-Wire bus up to 32,768 bytes.
- **Write Bit:** Writes a 1-Wire single bit with a value of 0 or 1 dependent on if **Logic 1** or **Logic 0** is selected to the 1-Wire bus.
- **Triplets:** Writes a single triplet with a branch direction of 0 or 1 dependent on if **Direction 1** or **Direction 0** is selected to the 1-Wire bus. This function assists in performing a Search ROM function on a 1-Wire bus.

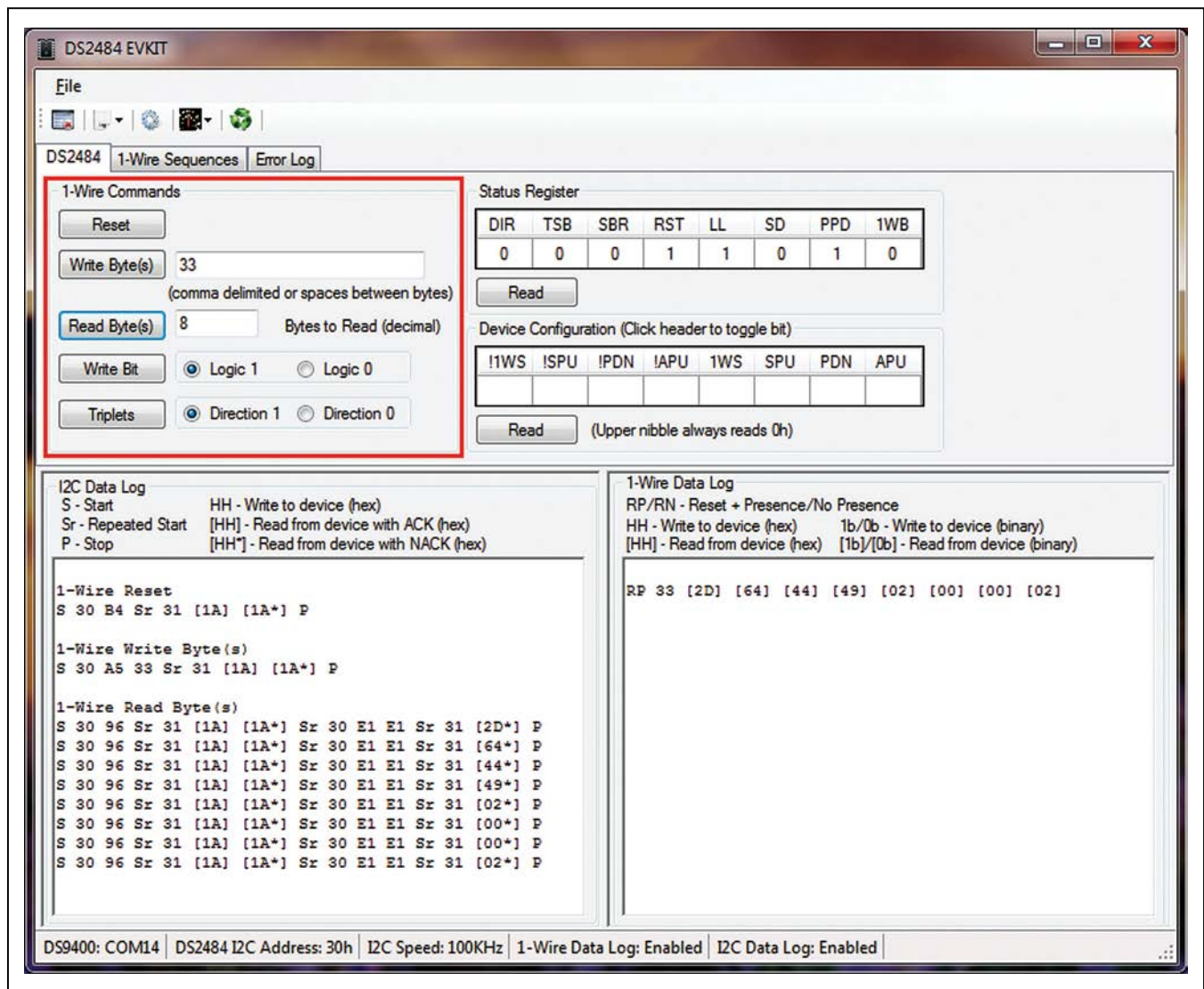

Figure 5. 1-Wire Commands Group Box

The **Status Register** group box (Figure 6) provides access to the DS2484's Status register bits. A **Read** performs a read of the Status register bits by the I<sup>2</sup>C interface. This is a read-only register. The software

application automatically updates the contents when a command alters any of the bits in the **Status Register** group box.

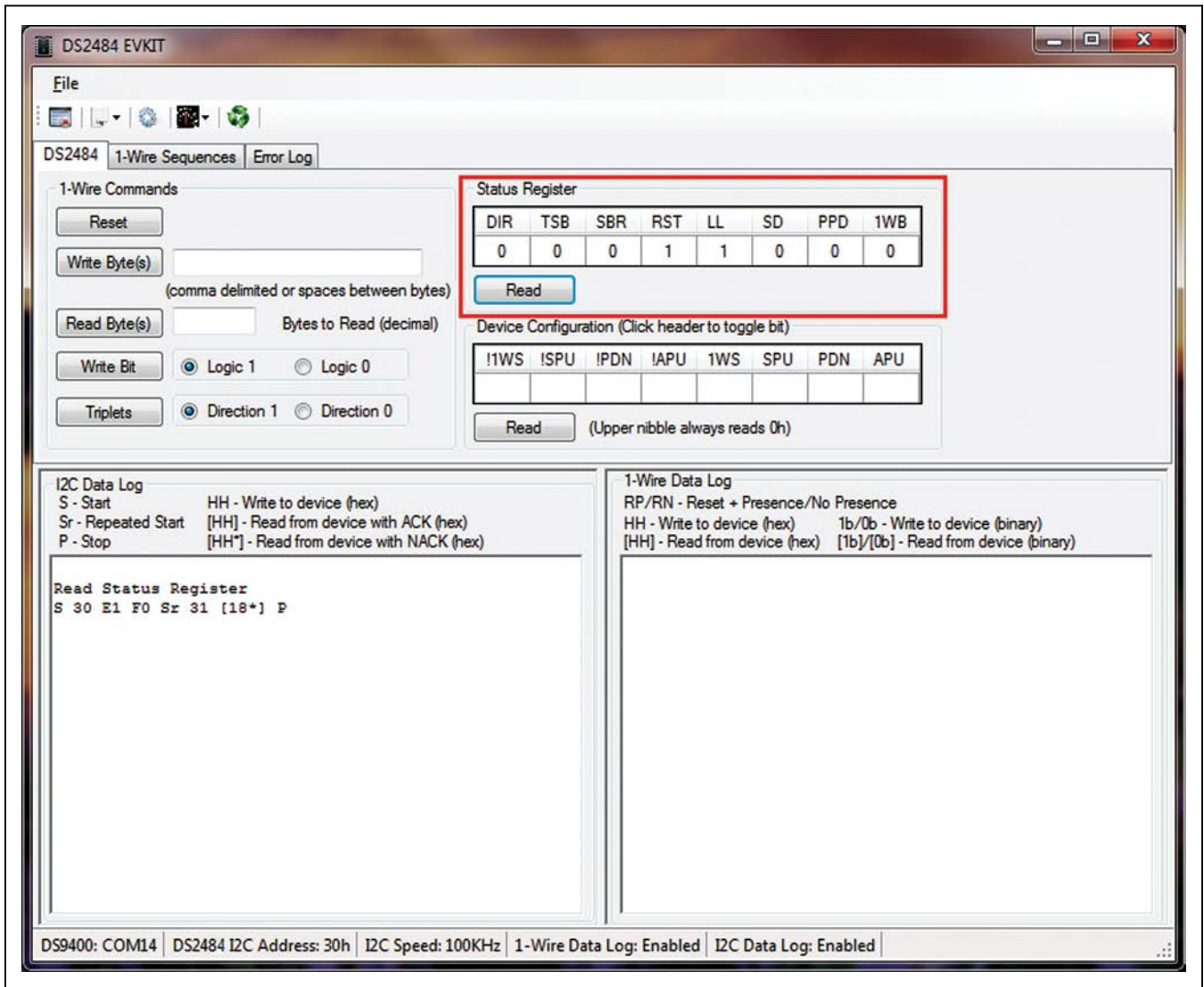

Figure 6. Status Register Group Box

The **Device Configuration** group box (Figure 7) provides access to the DS2484's Configuration register bits. A Read performs a **read** of the Device Configuration register bits. The upper nibble always reads 0h. Click on the header bit label to toggle the particular bit. When writing to the Device Configuration register, the new data is accepted

only if the upper nibble (bits 7:4) is the one's complement of the lower nibble (bits 3:0). Therefore, when a bit on the lower nibble is selected, the upper nibble bit with the same label and invert symbol (!) automatically shows as the one's complement. However, when reading the register, the upper nibble reads 0h.

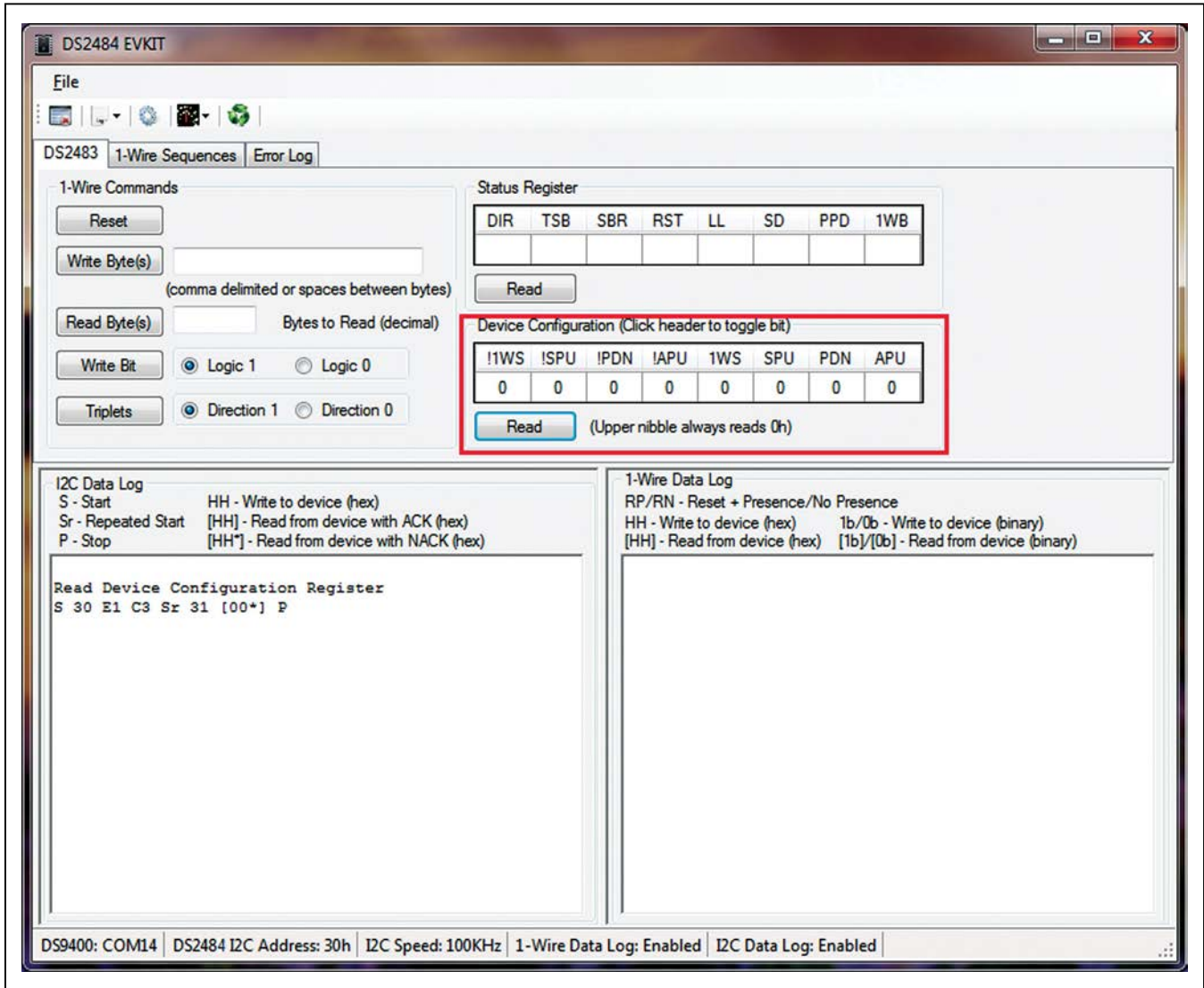

Figure 7. Device Configuration Group Box



**1-Wire Sequences Tab**

The **Single Slave** group box (Figure 8) allows the user to send 1-Wire command sequences to any 1-Wire slave device. Using these commands with multiple slaves on the line may cause data corruption (logical ANDing of bits). The following features are supported in the **Single Slave** group box:

- **Read ROM:** Sends a 1-Wire Reset command, Read ROM (33h) command followed by reading 8 bytes on

the 1-Wire bus. The ROM ID is then displayed and the CRC is verified.

- **Skip ROM:** Sends a 1-Wire Reset command followed by a Skip ROM (CCh) command on the 1-Wire bus. This is used to select a single 1-Wire slave device.
- **OD Skip ROM:** Sends a 1-Wire Reset command followed by an OD Skip ROM (3Ch) command on the Wire bus. This is used to place a single or all the 1-Wire slave devices on the 1-Wire bus into overdrive mode.

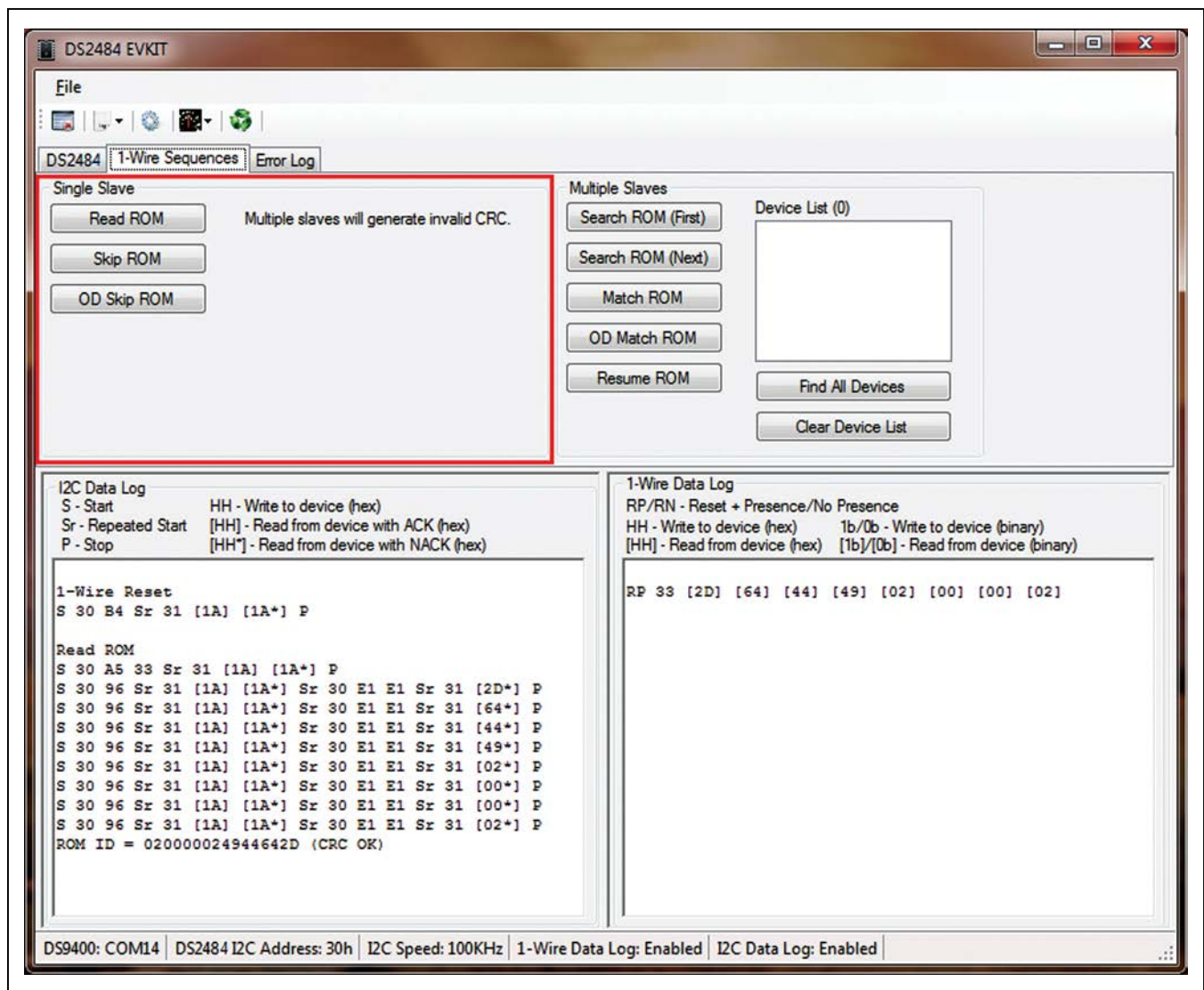

Figure 8. Single Slave Group Box

The **Multiple Slaves** group box ([Figure 9](#)) allows the user to send 1-Wire command sequences to any 1-Wire slave device. The following features are supported in the **Multiple Slaves** group box:

- **Search ROM (First):** Uses the Search ROM command (F0h) to perform the first sequence of the 1-Wire Search ROM algorithm to discover the “first” 1-Wire slave device on the 1-Wire bus. The “first” ROM ID is displayed in the **Device List**. Refer to Application Note 187: *1-Wire Search Algorithm* for more details.
- **Search ROM (Next):** Also uses the Search ROM command (F0h) in a sequence as to continue the 1-Wire Search ROM algorithm where the last binary search left off to discover the “next” 1-Wire slave device ROM ID.
- **Match ROM:** Sends the 1-Wire Reset command, followed by the Match ROM command (55h), followed by the ROM ID selected from the **Device List**. If no 1-Wire slave device is selected in the **Device List** or none is available to select, an “!” is displayed, indicating a warning that no device has been selected.
- **OD Match ROM:** Sends the 1-Wire Reset command, followed by the Match ROM command (69h), followed by the ROM ID selected from the **Device List**. If no 1-Wire slave device is selected in the **Device List** or

none is available to select, an “!” is displayed indicating a warning that no device has been selected. This places the selected 1-Wire slave device into overdrive mode.

- **Resume ROM:** Sends a 1-Wire Reset command followed by the Resume command (A5h).
- **Find All Devices:** Performs the entire Search ROM Algorithm sequence, and all the 1-Wire slave ROM IDs discovered are displayed in the **Device List**.
- **Clear Device List:** Removes all 1-Wire slave devices listed in the **Device List**.

### Log Group Boxes

The log group boxes provide all the outputs of the I<sup>2</sup>C bus and the 1-Wire bus. These logs can each be highlighted and copied to the clipboard for pasting into any windows program.

The **I<sup>2</sup>C Data Log** ([Figure 10](#)) allows the user to view all the I<sup>2</sup>C traffic transmitted and received from the I<sup>2</sup>C bus. This can assist the designer determining what I<sup>2</sup>C command sequences are needed to exercise the DS2484 device. The **I<sup>2</sup>C Data Log** displays the characters shown in [Table 1](#).

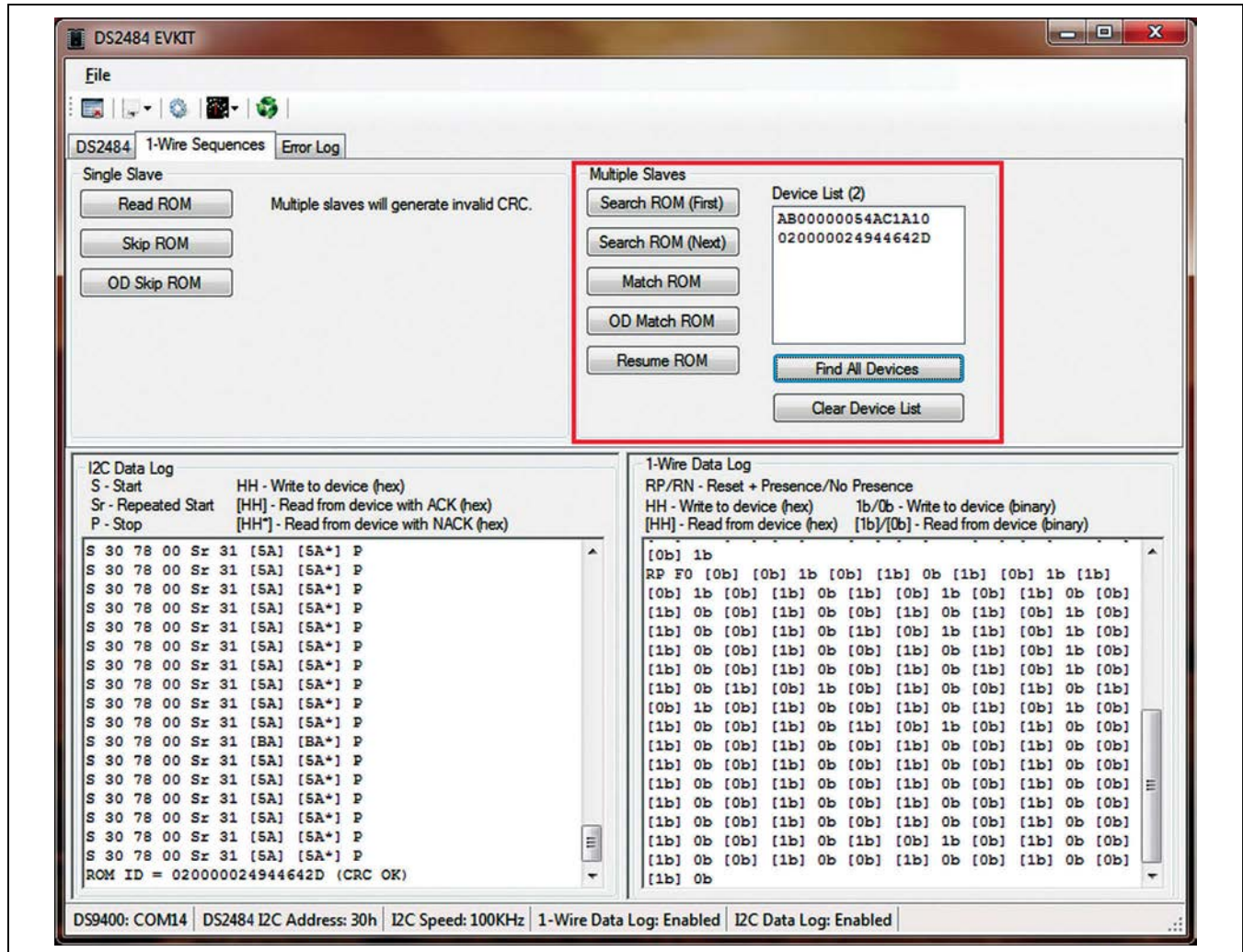

Figure 9. Multiple Slaves Group Box

Table 1. I<sup>2</sup>C Communication Key

KEY	FUNCTION
<b>S - Start</b>	I <sup>2</sup> C START command represented by a single “S” in a line.
<b>Sr - Repeated Start</b>	I <sup>2</sup> C repeated START command represented by “Sr” in a line.
<b>P - Stop</b>	I <sup>2</sup> C STOP command represented by a single “P” in a line.
<b>HH - Write to device (hex)</b>	I <sup>2</sup> C write from master to device represented by a pair of hex digits showing the byte that was transmitted.
<b>[HH] - Read from device with ACK (hex)</b>	I <sup>2</sup> C read from device represented by a pair of hex digits bounded by brackets “[ ]” showing that the byte that was received. This byte was ACKed by the master.
<b>[HH*] - Read from device with NACK (hex)</b>	I <sup>2</sup> C read from device represented by a pair of hex digits and an asterisk “*” bounded by brackets “[ ]” showing the byte that was received. This byte was NACKed by the master indicated that the master is done reading.

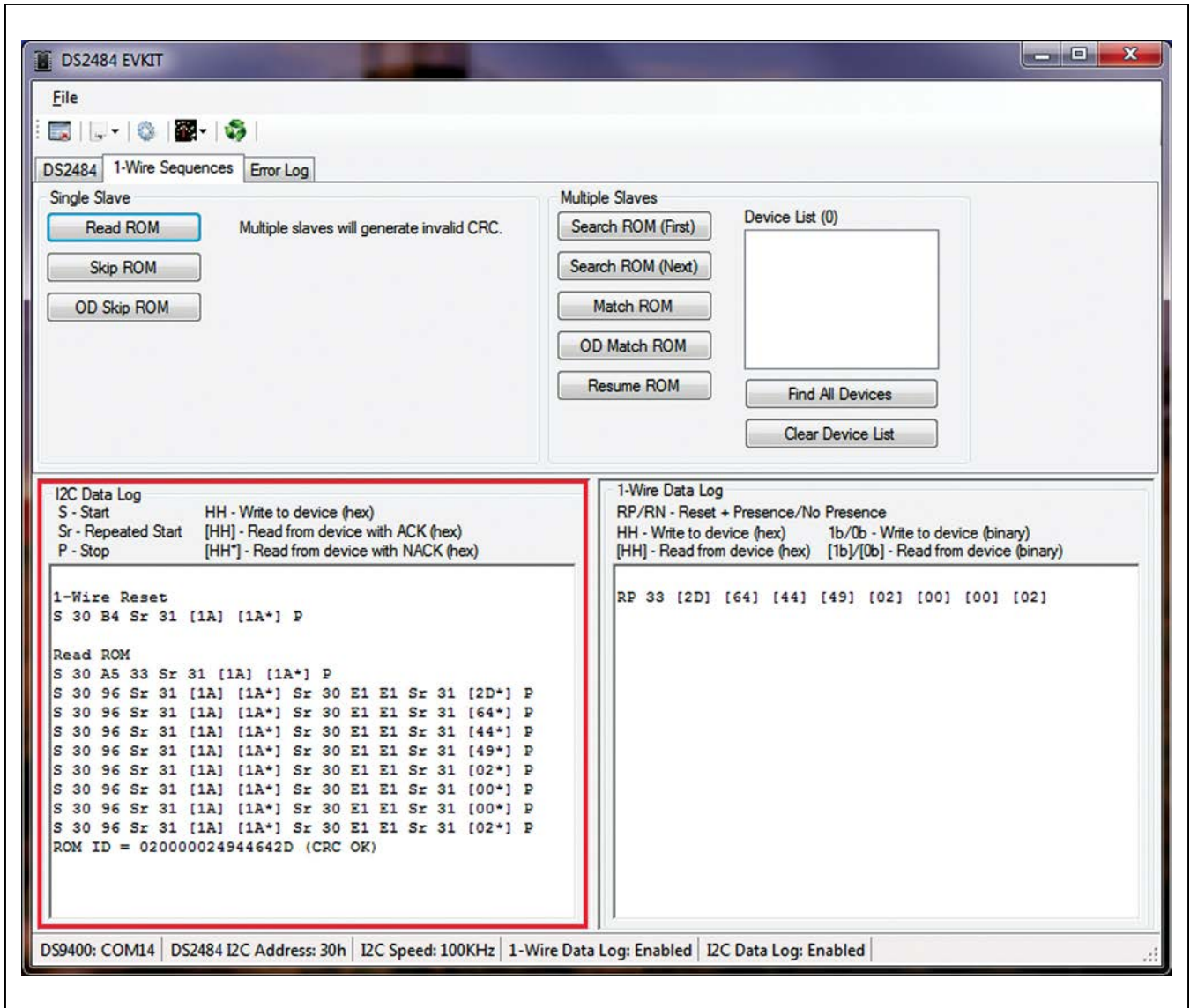

Figure 10. I2C Data Log Group Box

The **1-Wire Data Log** group box (Figure 11) allows the user to view all the 1-Wire traffic transmitted and received from the 1-Wire bus. This can assist the designer in determining what 1-Wire command sequences are

needed to exercise the DS2484 device and 1-Wire slave devices. The **1-Wire Data Log** displays the characters shown in Table 2.



Table 2. 1-Wire Communication Key

KEY	FUNCTION
RP - Reset + Presence	1-Wire reset and presence pulse response.
RN - Reset + No Presence	1-Wire reset and no presence pulse response.
HH - Write to device (hex)	1-Wire write from master to device represented by a pair of hex digits showing the byte that was transmitted.
[HH] - Read from device (hex)	1-Wire read from device represented by a pair of hex digits bounded by brackets “[ ]” showing the byte that was received.
1b/0b - Write to device (binary)	1-Wire write bit from master to device represented by a single binary digit (1/0).
[1b]/[0b] - Read from device (binary)	1-Wire read bit from master to device represented by a single binary digit (1/0) bounded by brackets “[ ]” showing the bit that was received.

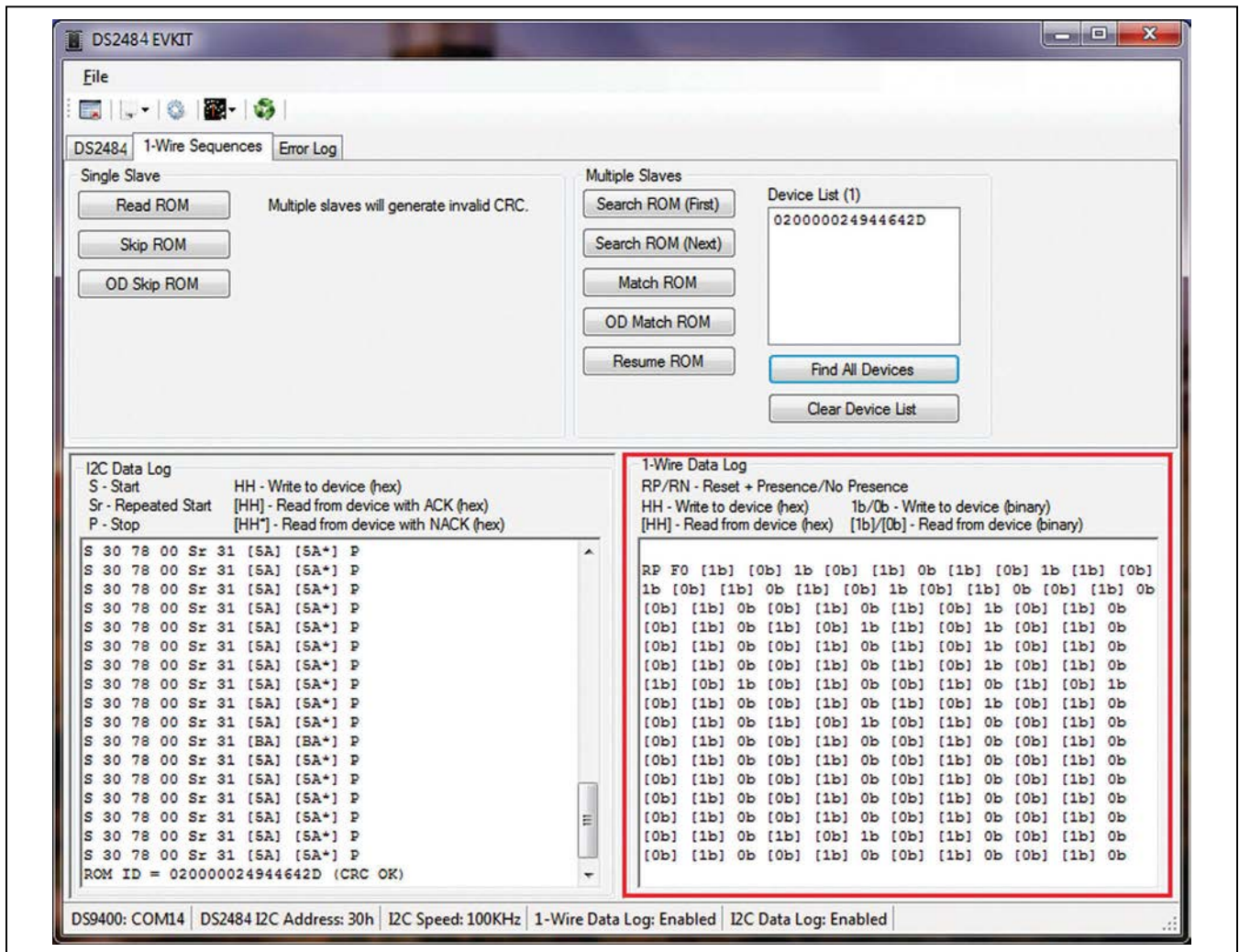

Figure 11. 1-Wire Data Log Group Box

The **Error Log** tab (Figure 12) allows the user to view any unhandled software exceptions. This error would display when the user does something that is outside the bounds of normal operation for the software and the software has

no way to handle the specific event. The exception as shown in Figure 12 was due to the user entering a value larger than what the Read Byte command could handle.

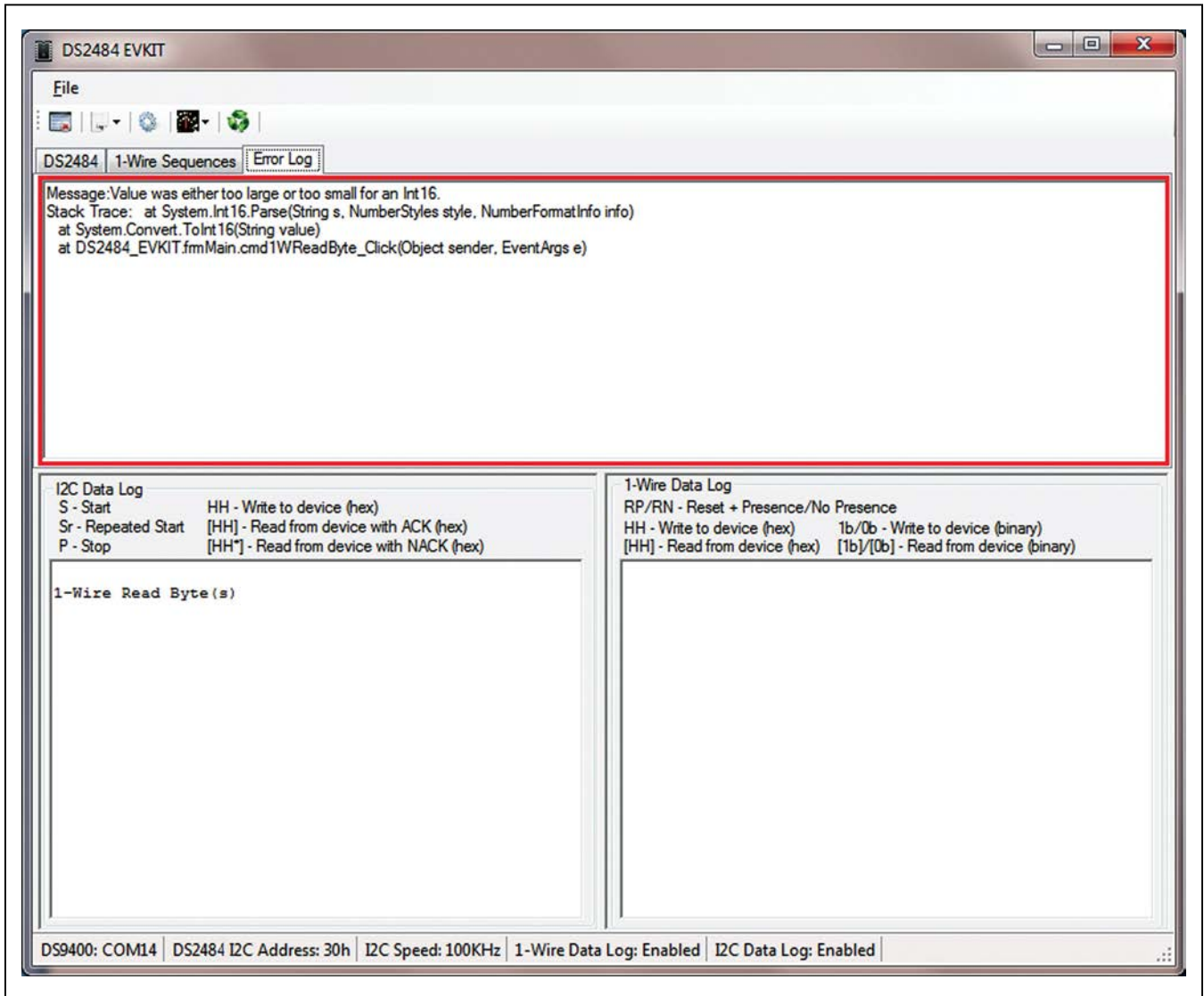

Figure 12. Error Log Tab

### Mini Tool Bar

The mini tool bar icon short descriptions are provided in [Figure 13](#). The following is the long description of each icon:

- **Device Reset:** Causes the DS2484 to perform an internal reset cycle caused from executing the Device Reset command followed by a read of the Device Configuration register.
- **Change I2C Speed:** Allows the I2C bus to run at the selected frequency of 100kHz or 400kHz. The selection only affects the microcontroller. The DS2484 does not have to be configured for speed.
- **Change 1-Wire Timing:** Provides reading of the Port Configuration register and writing of the Adjust 1-Wire Port. The window is shown in [Figure 14](#). Adjustment to any timing parameter shown is done by selecting the timing **Parameter** and **Speed**, adjusting the slider symbol, and clicking on the **Write** button. Verification of the write can be done by clicking on the **Read** button. Exit by clicking on the **Close** button.

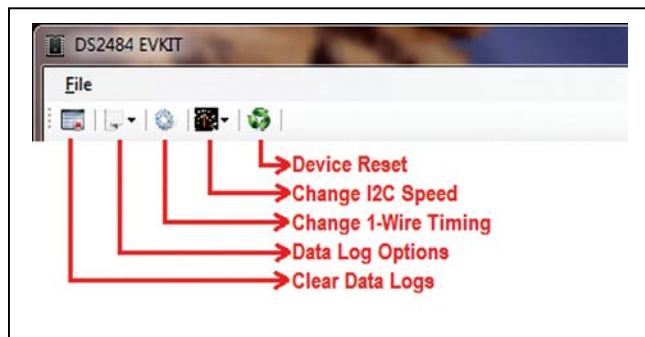

Figure 13. Mini Tool Bar

- **Data Log Options:** Allows selecting to turn on/off the **1-Wire Data Log** or **I2C Data Log**.
- **Clear Data Logs:** Clears all data log group boxes.

### Viewer Menu

The viewer menu consists only of **File** with the only option in the drop-down menu to **Exit**. **Exit** closes the program. The program also ends by the keyboard keys (**Alt + f**) and then (**x**).

### Detailed Description of Connectors/ Jumpers

#### RJ11 Pinout

The RJ11 pinout mounted on the EV kit PCB at RJ1 is shown in [Table 3](#) and [Figure 15](#). RJ11 pin 1 can supply 3.3V or 1.8V and can be used for auxiliary board power. GND is ground of the 3.3V or 1.8V supply, depending on jumper settings. The signal 1-WIRE stands for the one-wire data bus. The ground return 1-WIRE is the signal GND\_RTN. Pins 5 and 6 marked as NC are not connected.

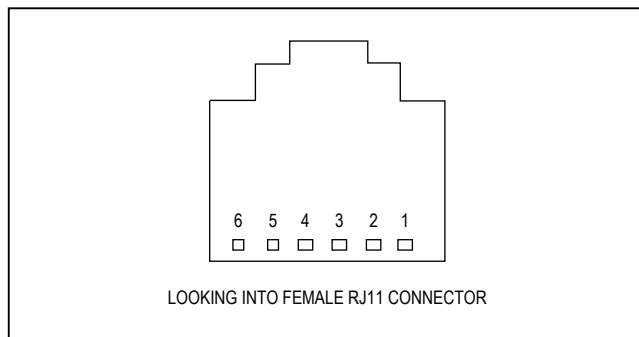

Figure 15. 1-Wire RJ11 Port

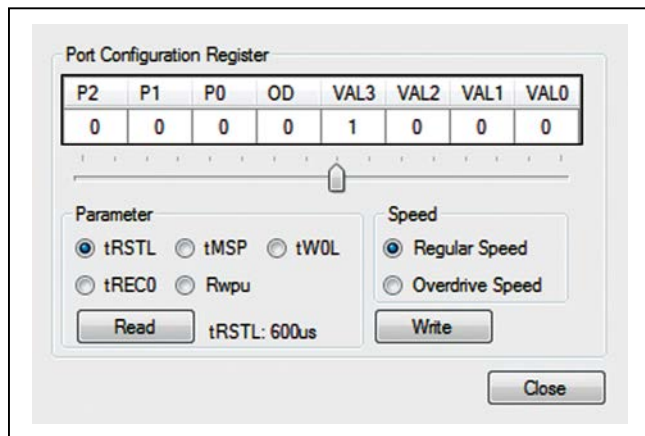

Figure 14. Port Configuration Register

Table 3. 1-Wire RJ11 Pinout

CONNECTOR PIN #	SIGNAL NAME
1	VCC
2	GND
3	1-WIRE
4	GND_RTN
5	NC
6	NC

### J2 Pinout

The 4-position 100-mil-spaced I<sup>2</sup>C I/F connector is mounted at J2 of the EV kit PCB, as shown in [Table 4](#). These signals are routed to U2 of the MAX3394E IC that is used as a dual-level translator to allow either 1.8V or 3.3V I<sup>2</sup>C signals to U3 of the DS2484 IC. J2 of the EV kit can be connected to J2 of the DS9400 for a complete EV system. The SDA\_PORT signal is the I<sup>2</sup>C serial-data input/output port and the SDC\_PORT is the I<sup>2</sup>C Serial-clock input port.

### Jumper Settings

The EV kit has three jumpers that are needed to select power-supply inputs for the DS2484 IC. [Figure 16](#) to [Figure 19](#) show the most common power-supply input selections for the DS2484 device.

**Table 4. I<sup>2</sup>C I/F Pinout**

CONNECTOR PIN #	SIGNAL NAME
1	VCC3.3
2	SDA_PORT
3	GND
4	SCL_PORT

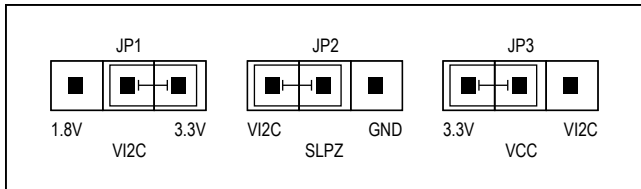

Figure 16. 3.3V Operation for Both the I<sup>2</sup>C and 1-Wire Interfaces

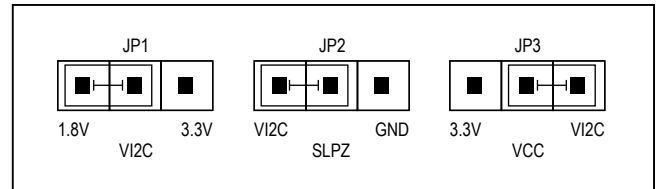

Figure 18. 1.8V I<sup>2</sup>C I/F and 1.8V 1-Wire

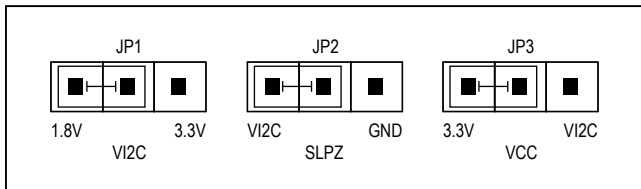

Figure 17. 1.8V I<sup>2</sup>C I/F and 3.3V 1-Wire

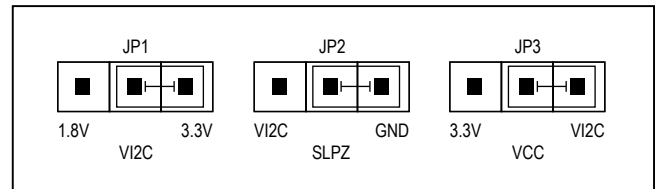

Figure 19. Powered Down (Sleep Mode)



Component List

DESIGNATION	QTY	DESCRIPTION
C1, C2	2	1µF ±10%, 10V ceramic capacitors (0603) TDK Corporation C1608X5R1A105K
C3–C5	3	0.1µF ±10%, 16V X7R ceramic capacitors (0603) KEMET C0603C104K4RACTU
J1	1	3-position connector socket strip LOPRO Samtec SSA-132-S-G
J2	1	4-pin 100-mil female connector Samtec SSQ-104-02-T-S-RA
JP1, JP2, JP3	3	0.100, 3-position vertical 0.318 breakaway headers Tyco Electronics 9-146276-0
R1, R2	2	3.3kΩ ±1% resistors (0603) Yageo RC0603FR-073K3L
R3, R4	2	5.11Ω ±1% resistors (0603) Panasonic ERJ-8GEYJ5R1V

DESIGNATION	QTY	DESCRIPTION
RJ1	1	Connector mod jack, 6-6 PCB 50AU Tyco Electronics 5555165-1
TP1–TP7	7	Test points Keystone Electronics 5011
U1	1	High PSRR, low-dropout, 150mA linear regulator (5 SC70) Maxim MAX8891EXK18+
U2	1	Dual-channel level translator (8 TDFN-EP*) Maxim MAX3394EETA+T
U3	1	I <sup>2</sup> C-to-1-Wire master (6 SOT23) Maxim DS2484R+T
U4	1	2-/4-/6-/8-channel ±30kV ESD protectors (6/8/10 µDFN) Maxim MAX13202
—	3	LP with handle, 2-position shunt, 30AU TE Connectivity 881545-2
—	1	PCB: DS2484 EVKit Rev A

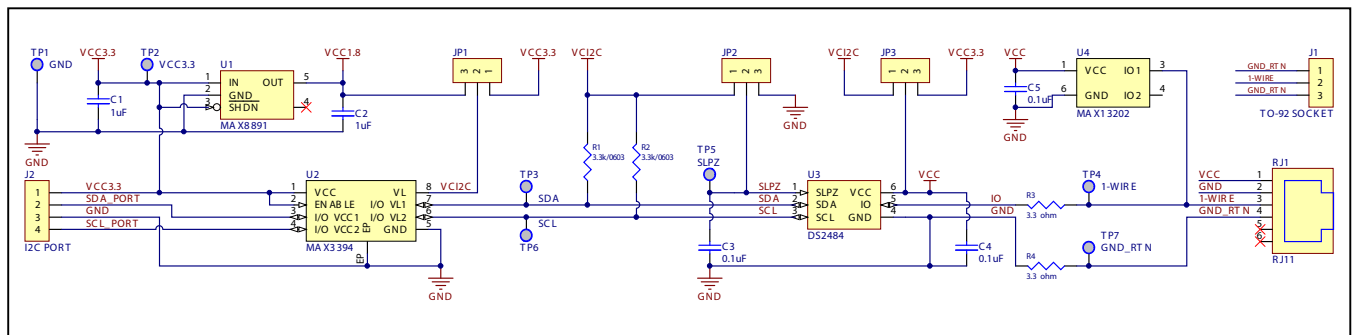

Figure 20. DS2484 EV Kit Schematic

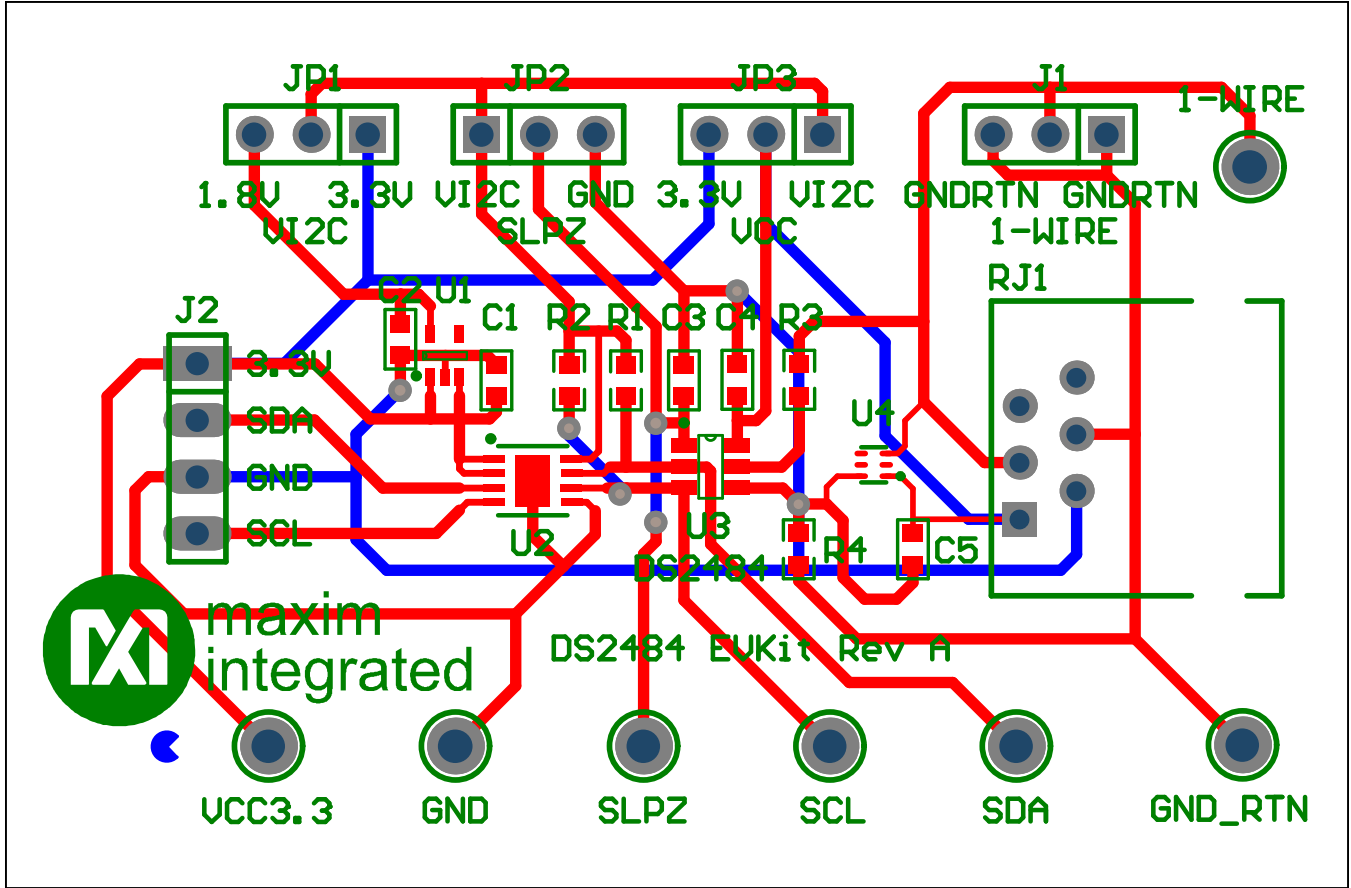

Figure 21. DS2484 EV Kit Composite Layout

### Ordering Information

PART	TYPE
DS2484EVKIT#	EV System

*#Denotes RoHS compliant.*

## Revision History

REVISION NUMBER	REVISION DATE	DESCRIPTION	PAGES CHANGED
0	1/14	Initial release	—

For pricing, delivery, and ordering information, please contact Maxim Direct at 1-888-629-4642, or visit Maxim Integrated's website at [www.maximintegrated.com](http://www.maximintegrated.com).

*Maxim Integrated cannot assume responsibility for use of any circuitry other than circuitry entirely embodied in a Maxim Integrated product. No circuit patent licenses are implied. Maxim Integrated reserves the right to change the circuitry and specifications without notice at any time.*