

THIS DRAWING IS UNPUBLISHED.  
 VERTRÄULICHE UNVERÖFFENTLICHTE ZEICHNUNG  
 © COPYRIGHT 20 BY -  
 RELEASED FOR PUBLICATION  
 FREI FÜR VERÖFFENTLICHUNG  
 ALL RIGHTS RESERVED.  
 ALLE RECHTE VORBEHALTEN.  
 MATED WITH:  
 PASSEND ZU:

PROJEKT NR.:		REVISIONS ÄNDERUNGEN			
P	LTR	DESCRIPTION BESCHREIBUNG	DATE	DWN	APVD
E		ECR-14-013059	02SEP2014	ABV	SA
E1		ECR-15-015157	20OCT2015	ABV	SA

Kodierungen  
CODINGS  
2:1

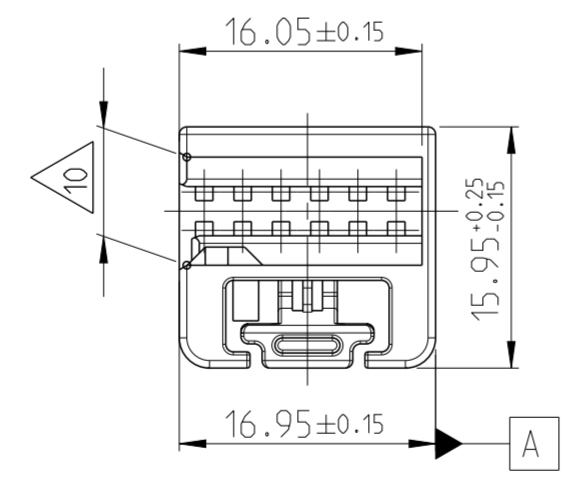
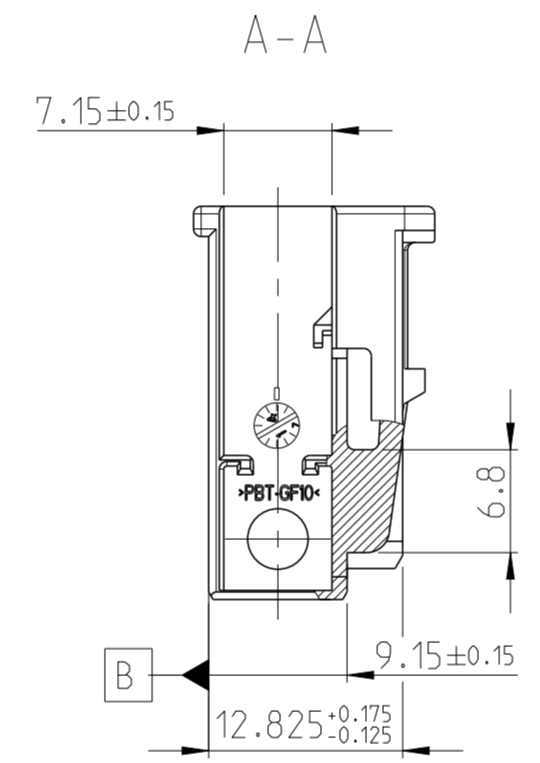
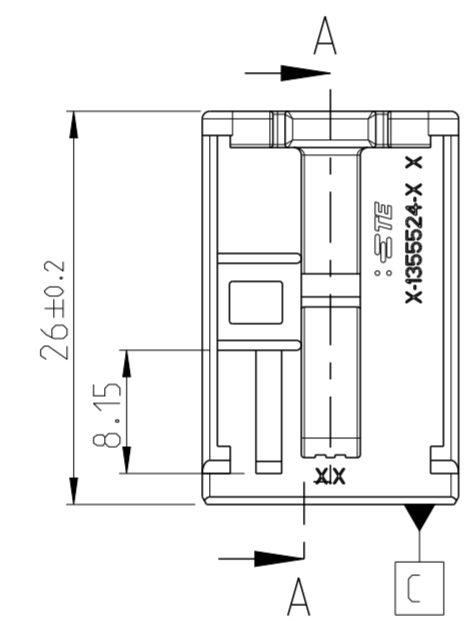
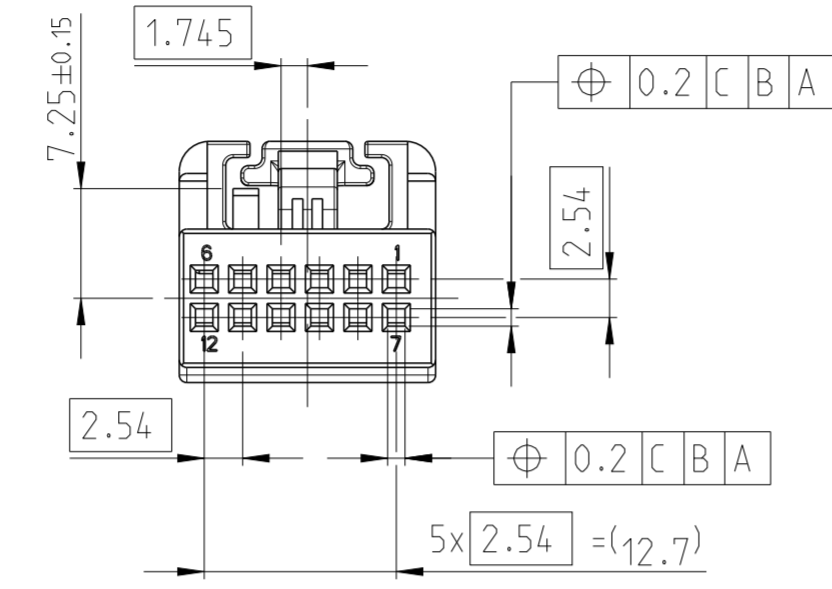
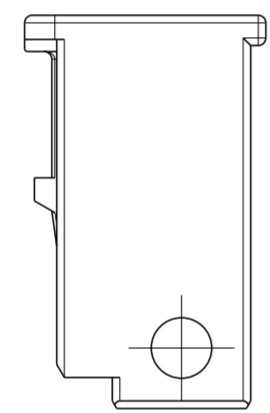
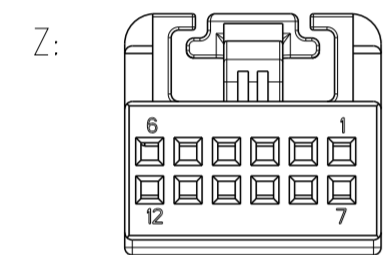
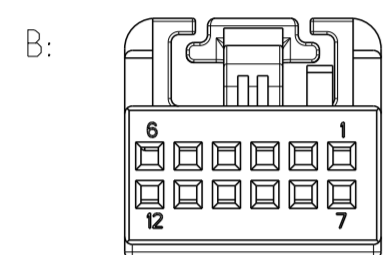
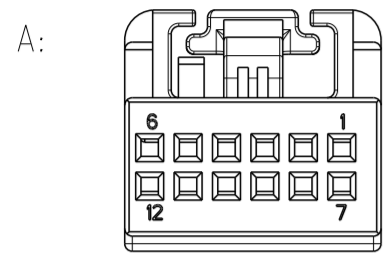

Bemerkungen  
NOTES

- Passend zu Buchsengehäuse, siehe Zeichnung TE: 1394048  
SUITABLE TO SOCKET HOUSING. SEE DRAWING
- Änderung nur mit Zustimmung der freigebenden Fachabteilung  
CHANGES ONLY WITH APPROVAL OF THE RESPONSIBLE DEPARTMENT
- Einzelheiten der Ausführung bleiben dem Hersteller überlassen  
THE MANUFACTURER CAN CHANGE DETAILS OF THE DESIGN
- Massgebend ist der deutsche Text  
ONLY THE GERMAN-LANGUAGE VERSION SHALL BE BINDING
- Formteilungsgrad zulaessig  
PART LINE PERMITTED MAX. 0.3
- Formteilungsversatz zulaessig  
SPLIT LINE PERMITTED MAX. 0.3
- Verpackung: Schuetztgut  
PACKAGING: LOOSE PIECE
- Zulaessiger Regeneratanteil  
RECYCLED MATERIAL PERMISSIBLE MAX. 25%
- Ausfuehrung Lieferantenlogo wahlweise  
SUPPLIER LOGO VERSION OPTIONAL
- Verzug zulaessig bis max. ±0.5 mm  
WARPAGE PERMITTED TO MAX. ±0.5 mm (E1)

1- -3 wie gezeichnet  
AS SHOWN

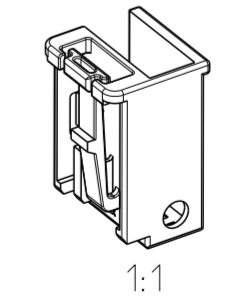

TE BESTELL-NR. ORDER NO.	REV.	KOD. COD.	BENENNUNG DESCRIPTION	OBERFLAECHE SURFACE FARBE/COLOUR	ART KIND GEWICHT WEIGHT	GRAMM	Passend zu: SUITABLE FOR: Stiftwanne PIN HEADER
9-1355524-3	E	Z	Abdeckkappe/COVER	wasserblau/WATER BLUE	S	2.3	1241768-2 1241768-1
2-1355524-3	E	B	Abdeckkappe/COVER	natur/NATURAL	S	2.3	
1-1355524-3	E	A	Abdeckkappe/COVER	schwarz/BLACK	S	2.3	

TOLERANCING ISO 8015 TOLERIERUNG ISO 8015		TOLERANCES UNLESS OTHERWISE SPECIFIED ACC. TO DIN 16901-140 @ CENTRIC TO NOMINAL DIMENSION. EDITION 1982-11 SHALL APPLY. Freimass toleranzen nach DIN 16901-140 @. Es gilt die Ausgabe 1982-11.	
DIESE ZEICHNUNG IST EIN KONTROLLIERTES DOKUMENT. BEMASSUNGEN UND TOLERANZEN GEMAESS GPS (ISO STANDARDS).		THIS DRAWING IS A CONTROLLED DOCUMENT. DIMENSIONING AND TOLERANCING PER GPS (ISO STANDARDS).	
DIMENSIONS: MASSEINHEITEN: (MM)		TOLERANCES UNLESS OTHERWISE SPECIFIED: ALL SAME TOLERANCES	
MATERIAL PBT-GF10		APVD - DWN Q.Patschula CHK J.Hahn	
MATERIAL		PRODUCT SPEC 108-18157	
MATERIAL		APPLICATION SPEC 114-18351	
MATERIAL		WEIGHT GEWICHT	
MATERIAL		CUSTOMER DRAWING	
MATERIAL		SCALE MASSSTAB	
MATERIAL		SHEET BLATT	
MATERIAL		RESTRICTED TO NUR FÜR	
MATERIAL		REV E1	

**STE** TE Connectivity

MICRO QUADLOK SYSTEM  
COVER, 12 POS  
Abdeckkappe, 12-pol.