

MATERIAL NO.	ENGINEERING NO.	LENGTH	POLES
1206142001	LW04000K03M020	78.7 (2M)	4
1206142002	LW05000K03M020	78.7 (2M)	5

NOTICE: THIS PART IS CSA AND FACTORY MUTUAL APPROVED
NO CHANGES CAN BE MADE TO THE ASSEMBLY, COMPONENTS
OR SUPPLIER WITHOUT PRIOR APPROVAL FROM CSA AND
FACTORY MUTUAL.

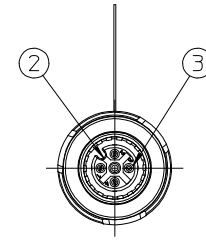
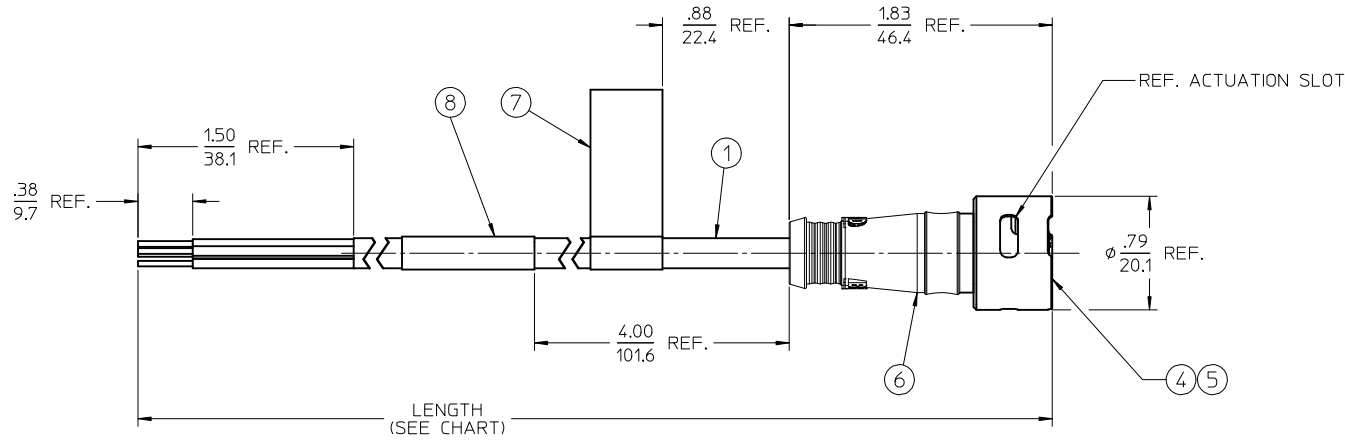
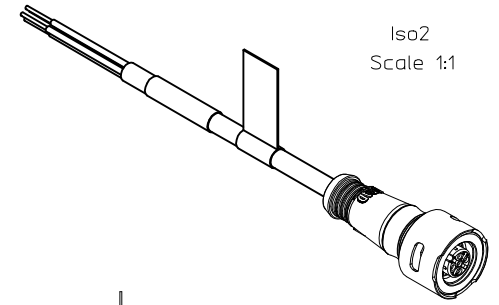

- NOTES:
1. MATERIAL: SEE TABLE
 2. FINISHES: SEE TABLE
 3. PRODUCT SPECIFICATIONS: PS-120614-001
 4. CONTROL DOC: ES-120614-001
 5. 3 & 4 POLE ELECTRICAL SPECIFICATIONS:
VOLTAGE RATING: 125V
CURRENT RATING: 4 AMPS
 6. 5 POLE ELECTRICAL SPECIFICATIONS:
VOLTAGE RATING: 32V
CURRENT RATING: 4 AMPS

② LW0X000K03MXXX

SINGLE END
POLE QTY.
HEAD STYLE
CABLE TYPE
FINISHED LENGTH
REF. XXX = METERS
EXAMPLE 010= 1M

FEMALE FACE VIEW		
3 POLE	4 POLE	5 POLE
1 BROWN 2 NOT USED 3 BLUE 4 BLACK 5 NOT USED	1 BROWN 2 WHITE 3 BLUE 4 BLACK 5 NOT USED	1 BROWN 2 WHITE 3 BLUE 4 BLACK 5 GRAY

8	1	WRAP LABEL	PLASTIC FILM	BLACK/YELLOW
7	1	FLAG LABEL (WARNING)	POLYESTER	BLACK/ORANGE
6	1	OVERMOLD	TPE	YELLOW
5	1	OUTER SLEEVE	ST. STEEL	PASSIVATED
4	1	INNER SLEEVE	ST. STEEL	PASSIVATED
3	XX	CONTACT	Cu ALLOY	GOLD PLATED
2	1	INSERT	PUR	BLACK
1	1	CABLE, #18 AWG ITC/PLTC	TPE	YELLOW
ITEM	QTY.	DESCRIPTION	MATERIAL	FINISH

ADDED P/N LEGEND	QUALITY SYMBOLS
EC NO: IPG2014-0138	▽=0
DRWR:RSTONE 2013/07/23	▽=0
CHKD:B WOODMAN 2013/08/01	
APPR:BMWOODMAN 2013/12/30	
REV	DESCRIPTION

GENERAL TOLERANCES (UNLESS SPECIFIED)	
mm	INCH
4 PLACES ± ---	± ---
3 PLACES ± ---	± ---
2 PLACES ± ---	± .01
1 PLACE ± 0.3	± ---
ANGULAR ± 2 °	

DRAFT WHERE APPLICABLE
MUST REMAIN
WITHIN DIMENSIONS

DIMENSION STYLE	
IN/MM	
DRAWN BY	DATE
RSTONE	2011/11/21
CHECKED BY	DATE
L. HARTMANN	2012/01/27
APPROVED BY	DATE
JFMURPHY	2012/04/18

SCALE	DESIGN UNITS	THIRD ANGLE PROJECTION
1.5:1	INCH	
ULTRA-LOCK ZONE 2 FEMALE, STRAIGHT K03, 18 AWG, TPE		
MOLEX INCORPORATED		SHEET NO. 1 OF 1
SEE CHART		DOCUMENT NO. SD-120614-011
THIS DRAWING CONTAINS INFORMATION THAT IS PROPRIETARY TO MOLEX INCORPORATED AND SHOULD NOT BE USED WITHOUT WRITTEN PERMISSION		

CLASS 1, DIVISION 2, GROUP A, B, C, OR D
HAZARDOUS LOCATION

NON-HAZARDOUS LOCATION

CLASS 1, DIVISION 2, GROUP A, B, C, OR D
HAZARDOUS LOCATION

NON-HAZARDOUS LOCATION

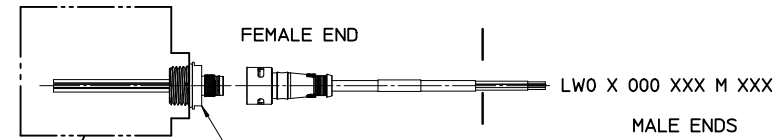

LWR X 006 A18 CXXX
(MALE 1/2" NPT)
LWR X A06 A18 CXXX
(MALE 1/4" NPT)

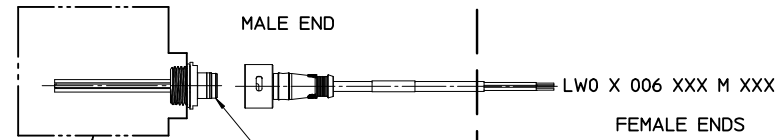
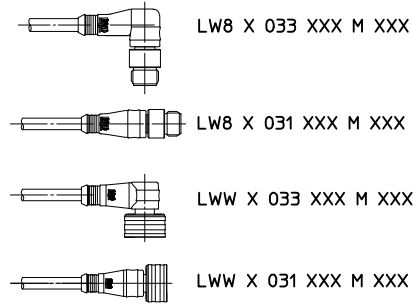
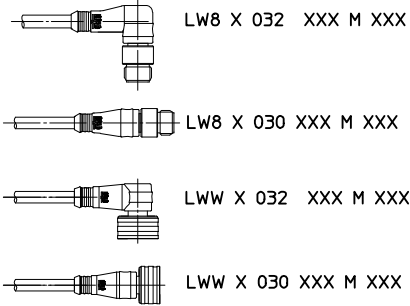

LWR X 000 A18 CXXX
(FEMALE 1/2" NPT)
LWR X A00 A18 CXXX
(FEMALE 1/4" NPT)

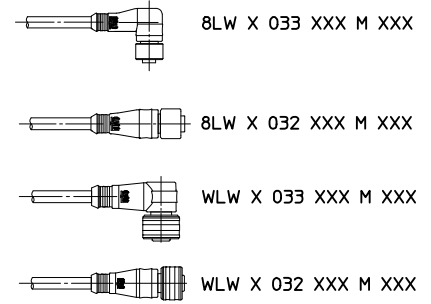
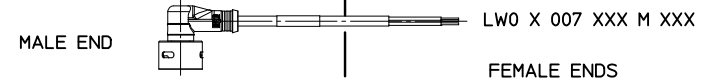
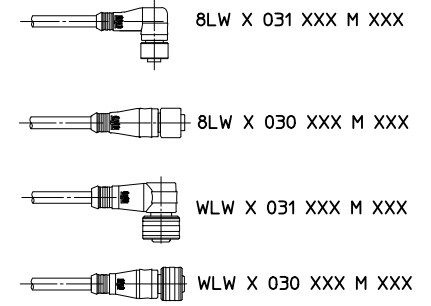

NOTES:

1. THE INSTALLATION MUST BE IN ACCORDANCE WITH THE NATIONAL ELECTRICAL CODE (NEC), ANSI/NFPA 70. SPECIFIC REQUIREMENTS FOR THE INSTALLATION OF ITC RATED CABLE MAY BE FOUND IN ARTICLE 501.4(B)(1)(5) AND ARTICLE 727.4
2. THE MOLDED CONSTRUCTION OF THE CORDSET AND GAS/VAPORTIGHT CONTINUOUS SHEATH OF THE CABLE MEET THE REQUIREMENTS OF THE NEC, ARTICLE 501-5(E)(2) FOR CABLE SEALS IN CLASS 1, DIVISION 2

⚠ FIELD DEVICE APPROVAL FOR CLASS 1, DIV. 2 OR CLASS 1, ZONE2 INSTALLATIONS

REF. SEE SHEET 3 FOR CONFIGURATION INFORMATION

NOTICE: THIS PART IS CSA AND FACTORY MUTUAL APPROVED
NO CHANGES CAN BE MADE TO THE ASSEMBLY, COMPONENTS
OR SUPPLIER WITHOUT PRIOR APPROVAL FROM CSA AND
FACTORY MUTUAL.

THIS DRAWING SUPERSEDES ES-120614-001 REV-B

<p>SEE SHEET 3 EC NO: IPG2018-0141 DRAWN BY: 2017/08/28 CHKD: BWOODMAN 2017/08/30 APPR: BWOODMAN 2017/09/06</p>	<p>QUALITY SYMBOLS ▽=0 ▽=0</p>	GENERAL TOLERANCES (UNLESS SPECIFIED)		DIMENSION STYLE IN/MM		SCALE 1:1	DESIGN UNITS INCH	THIRD ANGLE PROJECTION			
						TITLE CONTROL DOC FOR ULTRA-LOCK ZONE 2					
						DRAWN BY: RSTONE DATE: 2012/05/18					
						CHECKED BY: K JOZWIK DATE: 2012/05/22					
				APPROVED BY: JFMURPHY DATE: 2012/08/27							
		ANGULAR ±---°		MATERIAL NO. 1206149999		DOCUMENT NO. SD-120614-999		SHEET NO. 1 OF 3			
		DRAFT WHERE APPLICABLE MUST REMAIN WITHIN DIMENSIONS		SIZE C		THIS DRAWING CONTAINS INFORMATION THAT IS PROPRIETARY TO MOLEX INCORPORATED AND SHOULD NOT BE USED WITHOUT WRITTEN PERMISSION					

CLASS 1, DIVISION 2, GROUP A, B, C, OR D
HAZARDOUS LOCATION

HAZARDOUS LOCATION

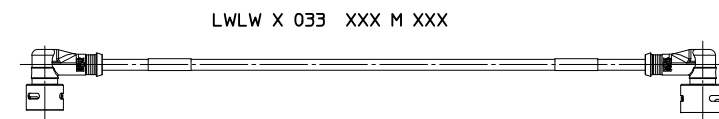
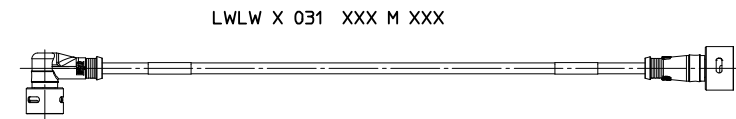
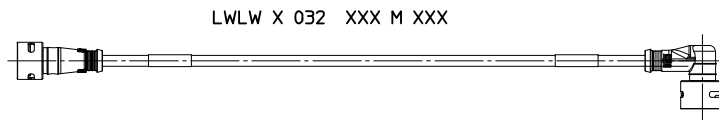
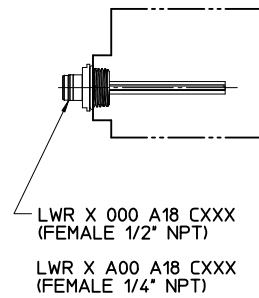
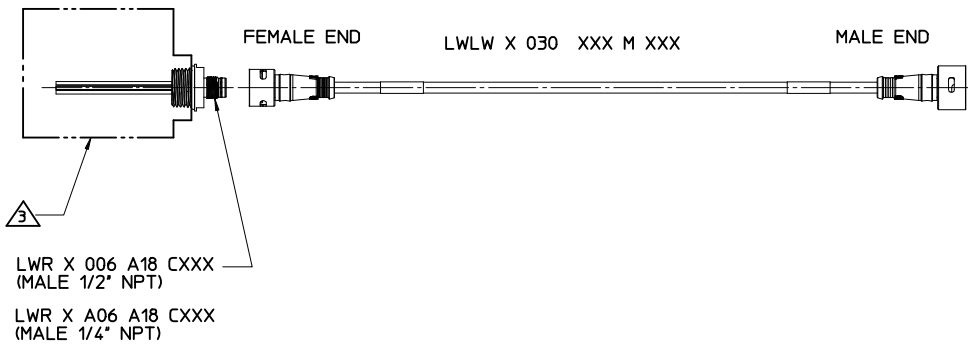

REF:

- 1. SEE SHEET 1 FOR NOTES
- 2. SEE SHEET 3 FOR CONFIGURATION INFORMATION

NOTICE: THIS PART IS CSA AND FACTORY MUTUAL APPROVED
NO CHANGES CAN BE MADE TO THE ASSEMBLY, COMPONENTS
OR SUPPLIER WITHOUT PRIOR APPROVAL FROM CSA AND
FACTORY MUTUAL.

SEE SHEET 3 EC NO: JFG2018-0141 2017/08/28 DRAWNR:STONE 2017/08/30 CHKD:WOODMAN 2017/09/06 APPR:WOODMAN	QUALITY SYMBOLS ▽=0 ▽=0	GENERAL TOLERANCES (UNLESS SPECIFIED)		DIMENSION STYLE IN/MM		SCALE 1:1	DESIGN UNITS INCH	THIRD ANGLE PROJECTION		
		4 PLACES ± --- ± --- 3 PLACES ± --- ± --- 2 PLACES ± --- ± --- 1 PLACE ± --- ± ---	mm INCH ± --- ± --- ± --- ± --- ± --- ± --- ± --- ± ---	DRAWN BY RSTONE	DATE 2012/05/18	TITLE CONTROL DOC FOR ULTRA-LOCK ZONE 2		MOLEX INCORPORATED		
REV	DESCRIPTION	MATERIAL NO. 1206149999		APPROVED BY JFMURPHY		DATE 2012/08/27		DOCUMENT NO. SD-120614-999		SHEET NO. 2 OF 3
DRAFT WHERE APPLICABLE MUST REMAIN WITHIN DIMENSIONS		THIS DRAWING CONTAINS INFORMATION THAT IS PROPRIETARY TO MOLEX INCORPORATED AND SHOULD NOT BE USED WITHOUT WRITTEN PERMISSION								

M12/MICROCHANGE ULTRA-LOCK CORD CONNECTORS AND CORD SETS

LWO 3 000 C02 M 020 8
 I II III IV V VI VII

I: CONNECTOR TYPE
 LWO= ULTRA-LOCK ZONE 2 MALE OR FEMALE SINGLE END CORDSET
 LWW= ULTRA-LOCK ZONE 2 FEMALE TO STANDARD ULTRA-LOCK MALE DOUBLE ENDED CORDSET
 WLW= ULTRA-LOCK ZONE 2 MALE TO STANDARD ULTRA-LOCK FEMALE DOUBLE ENDED CORDSET
 LW8= ULTRA-LOCK ZONE 2 FEMALE TO STANDARD M12 MALE DOUBLE ENDED CORDSET
 8LW= ULTRA-LOCK ZONE 2 MALE TO STANDARD M12 FEMALE DOUBLE ENDED CORDSET
 LWLW= ULTRA-LOCK ZONE 2 FEMALE TO ULTRA-LOCK ZONE 2 MALE DOUBLE ENDED CORDSET

II: NUMBER OF POLES: 3= 3 PIN, 4= 4 PIN, 5 = 5 PIN

III: CONFIGURATION
 SINGLE ENDED:
 000= STRAIGHT FEMALE CONNECTOR
 001= FEMALE 90°
 006= STRAIGHT MALE, EXTERNAL THREAD
 007= MALE 90°

DOUBLE ENDED:
 030= STRAIGHT FEMALE CONNECTOR TO STRAIGHT MALE CONNECTOR
 031= FEMALE 90° TO MALE STRAIGHT
 032= FEMALE STRAIGHT TO MALE 90°
 033= FEMALE 90° TO MALE 90°

IV: CABLE TYPE
 C02= SJ00W YELLOW, 18 AWG, DC CODE (CSA ONLY) **G**
 K03= PLTC/ITC, 18 AWG, TPE JACKET
 K05= PLTC/ITC, 22 AWG, TPE JACKET

V: UNIT OF MEASURE
 F= FEET
 M= METERS

VI: CABLE LENGTH (MAY BE ANY 3 DIGIT NUMBER FROM 001-100)
 1ST DIGIT= 10 X LENGTH
 2ND DIGIT= 1 X LENGTH
 3RD DIGIT= .1 X LENGTH

VII: COUPLING NUT MATERIAL
 ULTRA-LOCK ZONE 2 END(S) ARE STAINLESS STEEL

M12 OR ULTRA-LOCK:
 NONE = STANDARD MATERIAL (NICKEL PLATED BRASS)
 8= STAINLESS STEEL

**NOTICE: THIS PART IS CSA AND FACTORY MUTUAL APPROVED
 NO CHANGES CAN BE MADE TO THE ASSEMBLY, COMPONENTS
 OR SUPPLIER WITHOUT PRIOR APPROVAL FROM CSA AND
 FACTORY MUTUAL.**

M12/MICROCHANGE ULTRA-LOCK OUTLETS

LWR 3 A00 A18 M 020 8
 I II III IV V VI VII

I: CONNECTOR TYPE
 LWR= LOCKING INLETS AND OUTLETS

II: NUMBER OF POLES 3=3 PIN, 4= 4 PIN, & 5= 5 PIN

III: CONFIGURATION
 SINGLE ENDED:
 A00= FEMALE STRAIGHT (INT.THEAD) 1/4-18 NPT
 A06= MALE STRAIGHT (EXT.THEAD) 1/4-18 NPT
 000= FEMALE STRAIGHT (INT.THEAD) 1/2-14 NPT
 006= MALE STRAIGHT (EXT.THEAD) 1/2-14 NPT

G IV: WIRE TYPE
 A18= 22 AWG, PVC, DC COLOR CODE, UL TYPE 1061
 A16= 18 AWG, PVC, DC COLOR CODE, UL TYPE 1569

V: UNIT OF MEASURE
 A= INCHES
 F= FEET
 C= CENTIMETERS
 M= METERS

VI: WIRE LENGTH (MAY BE ANY 3 DIGIT NUMBER FROM 001-100)
 1ST DIGIT= 10 X LENGTH
 2ND DIGIT= 1 X LENGTH
 3RD DIGIT= .1 X LENGTH

VII: SHELL MATERIAL
 M12 OR ULTRA-LOCK:
 NONE = STANDARD MATERIAL (COPPER ZINC ALLOY)
 3= NICKEL PLATED BRASS
 8= STAINLESS STEEL

CORSET NOTE IV, ADD CSA OUTLET NOTE IV, REMOVE PCB PINS EC NO: IPG2018-0141 DR: MHRSTONE 2017/08/28 CHKD: BWOODMAN 2017/08/30 APPR: BWOODMAN 2017/09/06	DESCRIPTION G	QUALITY SYMBOLS	GENERAL TOLERANCES (UNLESS SPECIFIED)	DIMENSION STYLE IN/MM	SCALE 1:1	DESIGN UNITS INCH	THIRD ANGLE PROJECTION	
		▽=0	mm INCH	DRAWN BY DATE	CONTROL DOC FOR ULTRA-LOCK ZONE 2			
		▽=0	4 PLACES ± --- ± ---	RSTONE 2012/05/18				
				3 PLACES ± --- ± ---	CHECKED BY DATE	MOLEX INCORPORATED		
		2 PLACES ± --- ± ---	K JOZWIK 2012/05/22					
		1 PLACE ± --- ± ---	APPROVED BY DATE	DOCUMENT NO. SD-120614-999 SHEET NO. 3 OF 3				
		ANGULAR ± ---°	JFMURPHY 2012/08/27					
			MATERIAL NO. 1206149999	THIS DRAWING CONTAINS INFORMATION THAT IS PROPRIETARY TO MOLEX INCORPORATED AND SHOULD NOT BE USED WITHOUT WRITTEN PERMISSION				
			SIZE B					

CLASS 1, DIVISION 2, GROUP A, B, C, OR D
HAZARDOUS LOCATION

NON-HAZARDOUS LOCATION

CLASS 1, DIVISION 2, GROUP A, B, C, OR D
HAZARDOUS LOCATION

NON-HAZARDOUS LOCATION

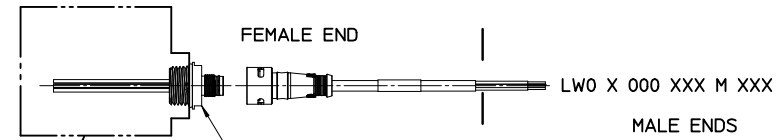

LWR X 006 A18 CXXX
(MALE 1/2" NPT)
LWR X A06 A18 CXXX
(MALE 1/4" NPT)

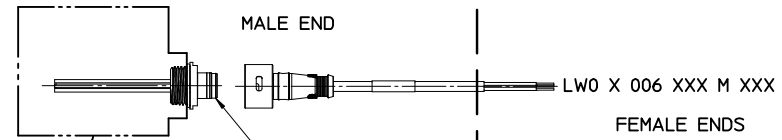
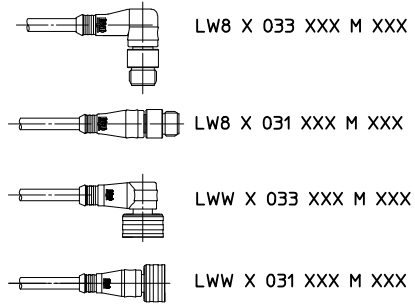
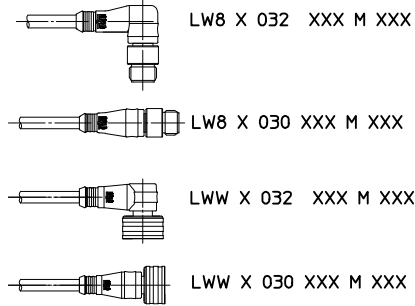

LWR X 000 A18 CXXX
(FEMALE 1/2" NPT)
LWR X A00 A18 CXXX
(FEMALE 1/4" NPT)

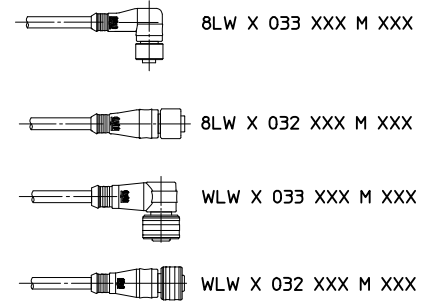
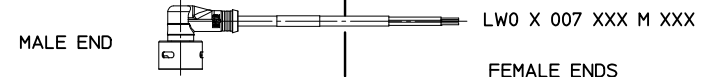
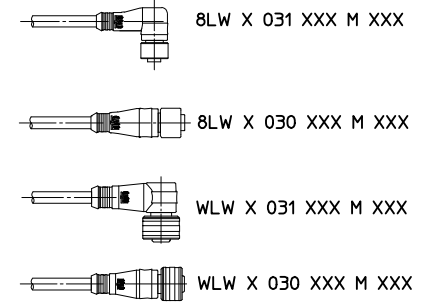

NOTES:

1. THE INSTALLATION MUST BE IN ACCORDANCE WITH THE NATIONAL ELECTRICAL CODE (NEC), ANSI/NFPA 70. SPECIFIC REQUIREMENTS FOR THE INSTALLATION OF ITC RATED CABLE MAY BE FOUND IN ARTICLE 501.4(B)(1)(5) AND ARTICLE 727.4
2. THE MOLDED CONSTRUCTION OF THE CORDSET AND GAS/VAPORTIGHT CONTINUOUS SHEATH OF THE CABLE MEET THE REQUIREMENTS OF THE NEC, ARTICLE 501-5(E)(2) FOR CABLE SEALS IN CLASS 1, DIVISION 2

FIELD DEVICE APPROVAL FOR CLASS 1, DIV. 2 OR CLASS 1, ZONE2 INSTALLATIONS

REF. SEE SHEET 3 FOR CONFIGURATION INFORMATION

NOTICE: THIS PART IS CSA AND FACTORY MUTUAL APPROVED
NO CHANGES CAN BE MADE TO THE ASSEMBLY, COMPONENTS
OR SUPPLIER WITHOUT PRIOR APPROVAL FROM CSA AND
FACTORY MUTUAL.

THIS DRAWING SUPERSEDES ES-120614-001 REV-B

<p>SEE SHEET 3 EC NO: IPG2018-0141 DRAWN BY: DRWINRSTONE 2017/08/28 CHKD: BWOODMAN 2017/08/30 APPR: BWOODMAN 2017/09/06</p>	<p>QUALITY SYMBOLS ▽=0 ▽=0</p>	GENERAL TOLERANCES (UNLESS SPECIFIED)		DIMENSION STYLE IN/MM		SCALE 1:1	DESIGN UNITS INCH	THIRD ANGLE PROJECTION		
						TITLE CONTROL DOC FOR ULTRA-LOCK ZONE 2				
						DRAWN BY: RSTONE DATE: 2012/05/18				
						CHECKED BY: K JOZWIK DATE: 2012/05/22				
				APPROVED BY: JFMURPHY DATE: 2012/08/27						
				ANGULAR ±---°						
		DRAFT WHERE APPLICABLE MUST REMAIN WITHIN DIMENSIONS		MATERIAL NO. 1206149999		DOCUMENT NO. SD-120614-999		SHEET NO. 1 OF 3		
				THIS DRAWING CONTAINS INFORMATION THAT IS PROPRIETARY TO MOLEX INCORPORATED AND SHOULD NOT BE USED WITHOUT WRITTEN PERMISSION						

CLASS 1, DIVISION 2, GROUP A, B, C, OR D
HAZARDOUS LOCATION

HAZARDOUS LOCATION

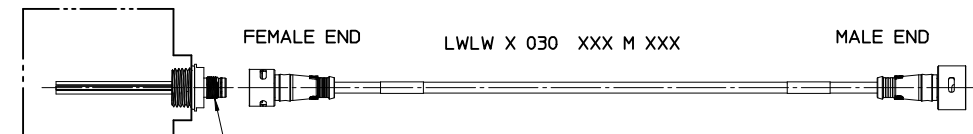

LWR X 006 A18 CXXX
(MALE 1/2" NPT)

LWR X A06 A18 CXXX
(MALE 1/4" NPT)

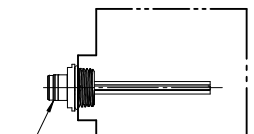

LWR X 000 A18 CXXX
(FEMALE 1/2" NPT)

LWR X A00 A18 CXXX
(FEMALE 1/4" NPT)

LWLW X 032 XXX M XXX

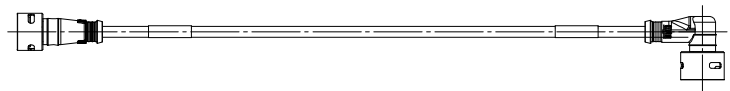

LWLW X 031 XXX M XXX

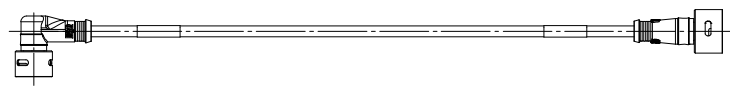

LWLW X 033 XXX M XXX

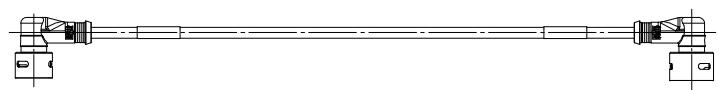

REF:

1. SEE SHEET 1 FOR NOTES
2. SEE SHEET 3 FOR CONFIGURATION INFORMATION

NOTICE: THIS PART IS CSA AND FACTORY MUTUAL APPROVED
NO CHANGES CAN BE MADE TO THE ASSEMBLY, COMPONENTS
OR SUPPLIER WITHOUT PRIOR APPROVAL FROM CSA AND
FACTORY MUTUAL.

SEE SHEET 3 EC NO: JFG2018-0141 2017/08/28 DRAWNR:STONE 2017/08/30 CHKD:WOODMAN 2017/09/06 APPR:WOODMAN	QUALITY SYMBOLS ▽=0 ▽=0	GENERAL TOLERANCES (UNLESS SPECIFIED)		DIMENSION STYLE IN/MM		SCALE 1:1	DESIGN UNITS INCH	THIRD ANGLE PROJECTION		
		4 PLACES ± --- ± --- 3 PLACES ± --- ± --- 2 PLACES ± --- ± --- 1 PLACE ± --- ± ---	mm INCH ± --- ± --- ± --- ± --- ± --- ± --- ± --- ± ---	DRAWN BY RSTONE	DATE 2012/05/18	TITLE CONTROL DOC FOR ULTRA-LOCK ZONE 2		MOLEX INCORPORATED		
REV	DESCRIPTION	MATERIAL NO. 1206149999		APPROVED BY JFMURPHY		DATE 2012/08/27		DOCUMENT NO. SD-120614-999		SHEET NO. 2 OF 3
DRAFT WHERE APPLICABLE MUST REMAIN WITHIN DIMENSIONS		THIS DRAWING CONTAINS INFORMATION THAT IS PROPRIETARY TO MOLEX INCORPORATED AND SHOULD NOT BE USED WITHOUT WRITTEN PERMISSION								

M12/MICROCHANGE ULTRA-LOCK CORD CONNECTORS AND CORD SETS

LWO 3 000 C02 M 020 8
 I II III IV V VI VII

I: CONNECTOR TYPE

- LWO= ULTRA-LOCK ZONE 2 MALE OR FEMALE SINGLE END CORDSET
- LWW= ULTRA-LOCK ZONE 2 FEMALE TO STANDARD ULTRA-LOCK MALE DOUBLE ENDED CORDSET
- WLW= ULTRA-LOCK ZONE 2 MALE TO STANDARD ULTRA-LOCK FEMALE DOUBLE ENDED CORDSET
- LW8= ULTRA-LOCK ZONE 2 FEMALE TO STANDARD M12 MALE DOUBLE ENDED CORDSET
- 8LW= ULTRA-LOCK ZONE 2 MALE TO STANDARD M12 FEMALE DOUBLE ENDED CORDSET
- LWLW= ULTRA-LOCK ZONE 2 FEMALE TO ULTRA-LOCK ZONE 2 MALE DOUBLE ENDED CORDSET

II: NUMBER OF POLES: 3= 3 PIN, 4= 4 PIN, 5 = 5 PIN

III: CONFIGURATION

- SINGLE ENDED:
 000= STRAIGHT FEMALE CONNECTOR
 001= FEMALE 90°
 006= STRAIGHT MALE, EXTERNAL THREAD
 007= MALE 90°

DOUBLE ENDED:

- 030= STRAIGHT FEMALE CONNECTOR TO STRAIGHT MALE CONNECTOR
- 031= FEMALE 90° TO MALE STRAIGHT
- 032= FEMALE STRAIGHT TO MALE 90°
- 033= FEMALE 90° TO MALE 90°

IV: CABLE TYPE

- C02= SJ00W YELLOW, 18 AWG, DC CODE (CSA ONLY) **G**
- K03= PLTC/ITC, 18 AWG, TPE JACKET
- K05= PLTC/ITC, 22 AWG, TPE JACKET

V: UNIT OF MEASURE

- F= FEET
- M= METERS

VI: CABLE LENGTH (MAY BE ANY 3 DIGIT NUMBER FROM 001-100)

- 1ST DIGIT= 10 X LENGTH
- 2ND DIGIT= 1 X LENGTH
- 3RD DIGIT= .1 X LENGTH

VII: COUPLING NUT MATERIAL

ULTRA-LOCK ZONE 2 END(S) ARE STAINLESS STEEL

M12 OR ULTRA-LOCK:

- NONE = STANDARD MATERIAL (NICKEL PLATED BRASS)
- 8= STAINLESS STEEL

NOTICE: THIS PART IS CSA AND FACTORY MUTUAL APPROVED
 NO CHANGES CAN BE MADE TO THE ASSEMBLY, COMPONENTS
 OR SUPPLIER WITHOUT PRIOR APPROVAL FROM CSA AND
 FACTORY MUTUAL.

M12/MICROCHANGE ULTRA-LOCK OUTLETS

LWR 3 A00 A18 M 020 8
 I II III IV V VI VII

I: CONNECTOR TYPE

LWR= LOCKING INLETS AND OUTLETS

II: NUMBER OF POLES 3=3 PIN, 4= 4 PIN, & 5= 5 PIN

III: CONFIGURATION

- SINGLE ENDED:
 A00= FEMALE STRAIGHT (INT.THEAD) 1/4-18 NPT
 A06= MALE STRAIGHT (EXT.THEAD) 1/4-18 NPT
 000= FEMALE STRAIGHT (INT.THEAD) 1/2-14 NPT
 006= MALE STRAIGHT (EXT.THEAD) 1/2-14 NPT

G IV: WIRE TYPE

- A18= 22 AWG, PVC, DC COLOR CODE, UL TYPE 1061
- A16= 18 AWG, PVC, DC COLOR CODE, UL TYPE 1569

V: UNIT OF MEASURE

- A= INCHES
- F= FEET
- C= CENTIMETERS
- M= METERS

VI: WIRE LENGTH (MAY BE ANY 3 DIGIT NUMBER FROM 001-100)

- 1ST DIGIT= 10 X LENGTH
- 2ND DIGIT= 1 X LENGTH
- 3RD DIGIT= .1 X LENGTH

VII: SHELL MATERIAL

- M12 OR ULTRA-LOCK:
- NONE = STANDARD MATERIAL (COPPER ZINC ALLOY)
- 3= NICKEL PLATED BRASS
- 8= STAINLESS STEEL

CORSET NOTE IV: ADD CSA OUTLET NOTE IV: REMOVE PCB PINS EC NO: IPG2018-0141 DR: MHRSTONE 2017/08/28 CHKD: BWOODMAN 2017/08/30 APPR: BWOODMAN 2017/09/06	QUALITY SYMBOLS ▽=0 ▽=0	GENERAL TOLERANCES (UNLESS SPECIFIED) mm INCH 4 PLACES ±--- ±--- 3 PLACES ±--- ±--- 2 PLACES ±--- ±--- 1 PLACE ±--- ±--- ANGULAR ±---°	DIMENSION STYLE IN/MM DRAWN BY DATE RSTONE 2012/05/18 CHECKED BY DATE K JOZWIK 2012/05/22 APPROVED BY DATE JFMURPHY 2012/08/27	SCALE 1:1	DESIGN UNITS INCH	THIRD ANGLE PROJECTION ☉	CONTROL DOC FOR ULTRA-LOCK ZONE 2
	MOLEX INCORPORATED						
	DRAFT WHERE APPLICABLE MUST REMAIN WITHIN DIMENSIONS			MATERIAL NO. 1206149999	DOCUMENT NO. SD-120614-999		SHEET NO. 3 OF 3
	THIS DRAWING CONTAINS INFORMATION THAT IS PROPRIETARY TO MOLEX INCORPORATED AND SHOULD NOT BE USED WITHOUT WRITTEN PERMISSION						