



HQA DC-DC Power Module Series

9-40V Wide Input, 120W Output
Quarter Brick

The HQA Series of DC-DC converters offers a high performance quarter brick package with true usable power, a wide range input voltage operation range, and a broad selection of operating output voltages. A rugged package design with encapsulation, multiple baseplate and testing options make HQA modules suitable for use in a wide variety of harsh and demanding environments.

Features

- Size – 60.6mm x 55.9 mm x 12.7 mm (2.39 in. x 2.2 in. x 0.5 in.) – flanged base plate
- Encapsulated for rugged environments
- Qualification methods consistent with MIL-STD-883F and MIL-STD-202G
- Through hole pins 4.57mm tail length
- Up to 120W of output
- Negative logic on/off
- Low output noise
- Output voltage adjustment
- Constant switching frequency
- Remote Sense (selected models)
- Fully regulated control loop with no opto-couplers, allows high temperature operation
- Full, auto-recovery protection:
 - Input under voltage
 - Output Over current

Options

- Size - 60.6mm x 39 mm x 12.7 mm (2.39 in. x 1.54 in. x 0.5 in.) – non-flanged base plate
- Clock Synchronization
- Enhanced Reliability M grade Screening and Components

Ordering information:

Product Identifier	Package Size	Platform	Input Voltage	Output Current/ Power	Output Units	Main Output Voltage	# of Outputs		Feature Set Indicator		Screening Indicator
H	Q	A	2W	120	W	280	V	-	007	-	S
Heavy Duty	Quarter brick	A series	2W - 09-40V 24 - 18-40	120	A - Amps W - Watts	480 - 48 280 - 28 240 - 24 150 - 15 120 - 12 050 - 5	V - Single		007 - Standard		S - Standard M - Enhanced

Option Table:

Feature Set	Negative Logic On/Off	0.180" Pin Length	Flanged Base Plate	Non-Flanged Base Plate	Standard Screening	Enhanced Screening
007-S	X	X	X		X	
N07-S	X	X		X	X	
007-M	X	X	X			X

Product Offering:

Code	Vin	Vout	Iout (A)	Maximum Output Power (W)	Remote Sense Standard
HQA24120W480V-007-S	18-40	48	2.5	120	No
HQA2W120W280V-007-S	9-40	28	4.2	120	No
HQA2W120W240V-007-S	9-40	24	5	120	No
HQA2W120W150V-007-S	9-40	15	8	120	Yes
HQA2W120W120V-007-S	9-40	12	10	120	Yes
HQA2W120W050V-007-S	9-40	5	24	120	Yes

Mechanical Specification: (with flange)

Dimensions are in mm [in]. Unless otherwise specified tolerances are:
 $x.x [x.xx] \pm 0.5 [0.02]$, $x.xx [x.xxx] \pm 0.25 [0.010]$

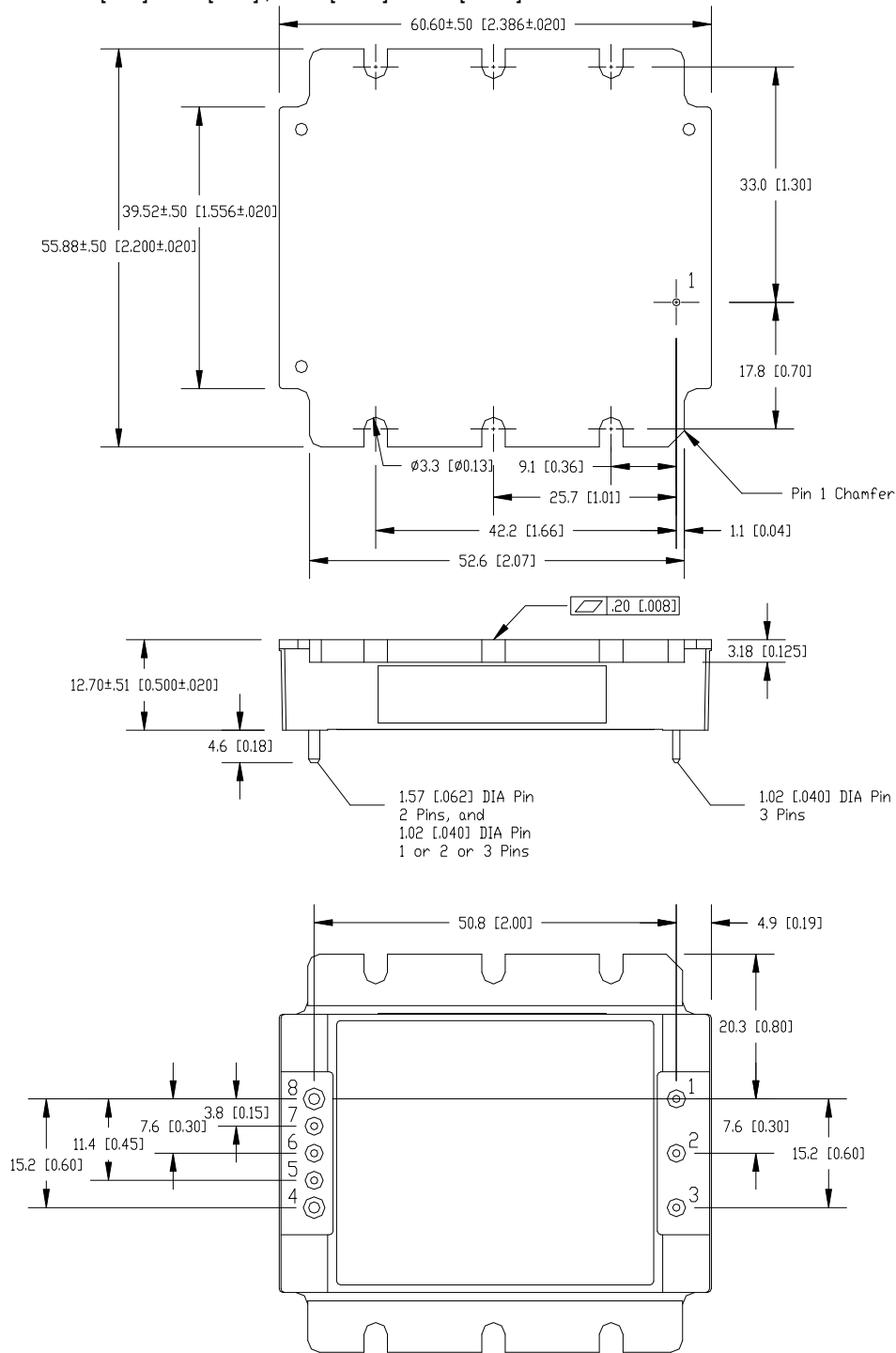

Mechanical Specification: (no flange)

Dimensions are in mm [in]. Unless otherwise specified tolerances are:
x.x [x.xx] ± 0.5 [0.02], x.xx [x.xxx] ± 0.25 [0.010]

To avoid damaging components, do not exceed 3.0mm [0.12"] depth for M3 screws

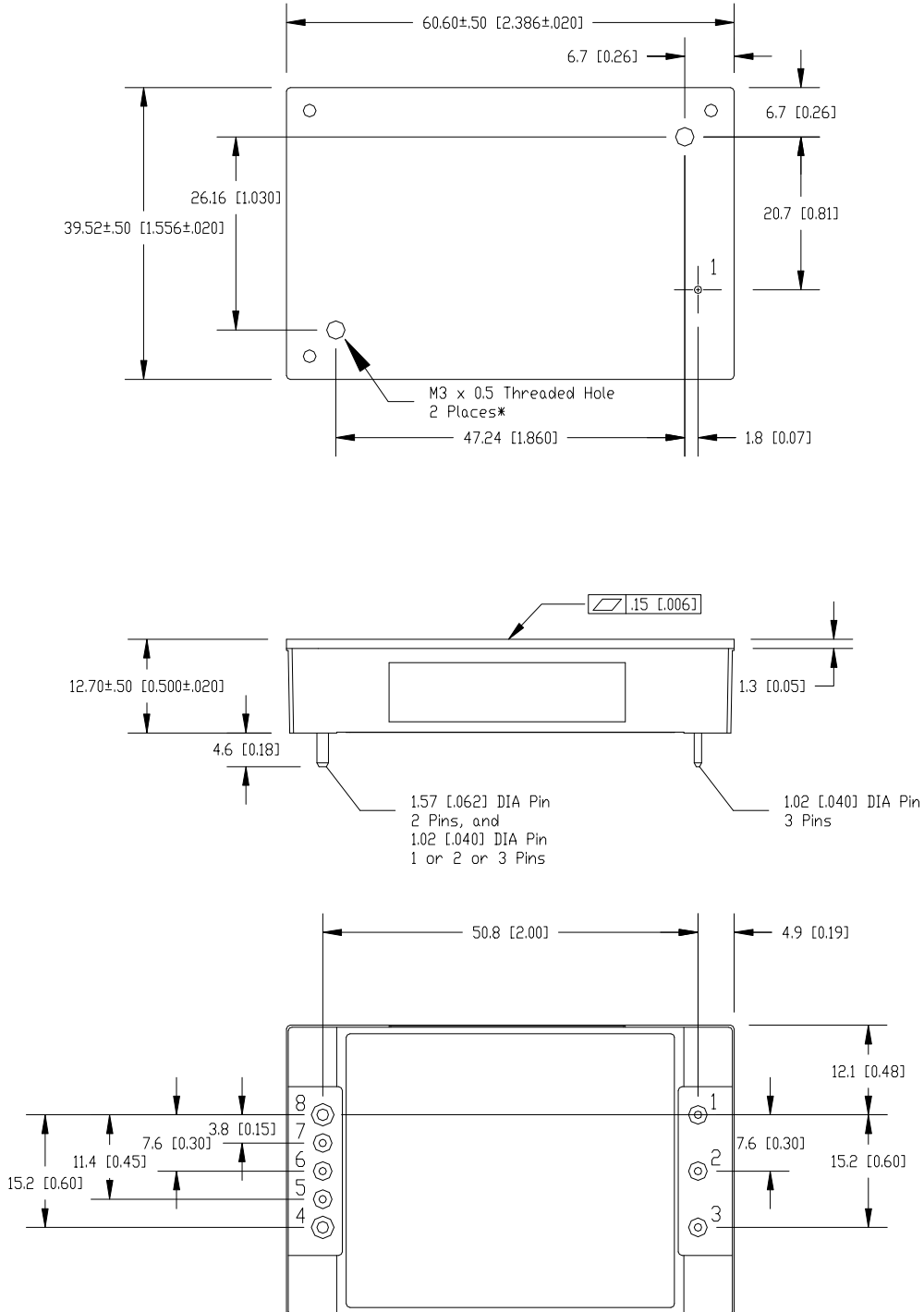

Recommended Hole Pattern: (top view with flange)

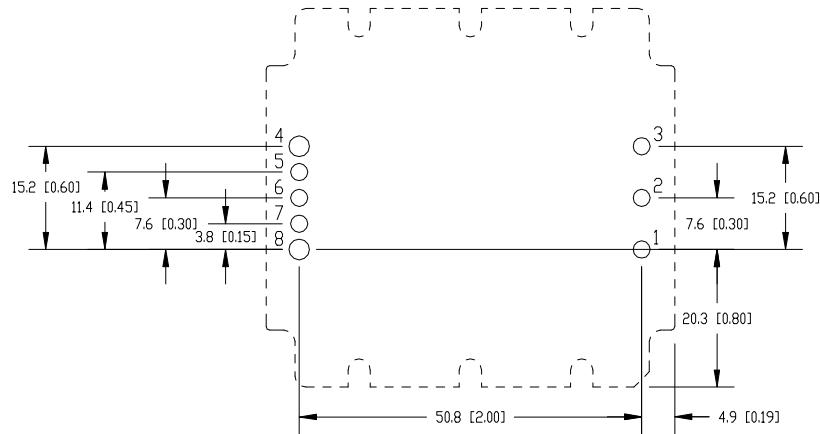

(without flange)

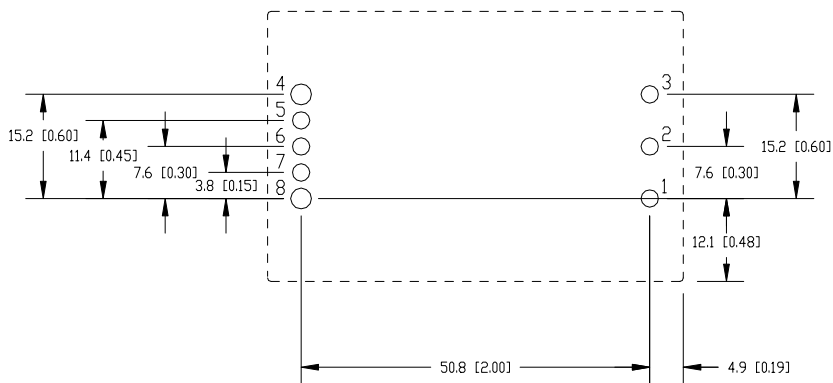

Pin Assignment:

PIN	FUNCTION	PIN	FUNCTION
1	Vin(+)	5	sense (-), select models
2	On/Off	6	Trim
3	Vin(-)	7	sense (+), select models
4	Vo(-)	8	Vo(+)

Pin base material is tellurium copper with tin over nickel plating; the maximum module weight is 100g (3.5oz)

Absolute Maximum Ratings:

Stress in excess of Absolute Maximum Ratings may cause permanent damage to the device.

Characteristic		Min	Max	Unit	Notes & Conditions
Continuous Input Voltage		-0.5	40	Vdc	
Transient Input Voltage		---	50	Vdc	(t < 1s)
Isolation Voltage		---	2250	Vdc	Input to Output
		---	2250	Vdc	Baseplate to Input or Output
Storage Temperature		-65	125	°C	
Operating Temperature Range (Tc)	-S option	-40	115*	°C	Measured at the location specified in the thermal measurement figure. Maximum temperature varies with model number, output current, and module orientation – see curve in thermal performance section of the data sheet.
	-M option	-55	115*	°C	

*Engineering estimate

Input Characteristics:

Unless otherwise specified, specifications apply over all Rated Input Voltage, Resistive Load, and Temperature conditions.

Characteristic	Min	Typ	Max	Unit	Notes & Conditions
Operating Input Voltage	10	---	40	Vdc	All except 48Vout
Operating Input Voltage (48Vout)	18.5	---	40	Vdc	
Maximum Input Current	---	---	18	A	Vin = 0 to Vin,max; all except 48Vout
Maximum Input Current (48Vout)	---	---	10	A	Vin = 0 to Vin,max
Turn-on Voltage	---	9.5	10.5	Vdc	All except 48Vout
Turn-on Voltage (48Vout)	---	17	18	Vdc	
Turn-off Voltage	---	8.5	9	Vdc	All except 48Vout
Turn-off Voltage (48Vout)	---	15.5	17.5	Vdc	
Hysteresis	---	1	---	Vdc	
Startup Delay Time from application of input voltage	---	5	---	mS	Vo = 0 to 0.1*Vo,nom; on/off =on, Io=Io,max, Tc=25°C
Startup Delay Time from on/off	---	5	---	mS	Vo = 0 to 0.1*Vo,nom; Vin = Vi,nom, Io=Io,max, Tc=25°C
Output Voltage Rise Time	---	20	---	mS	Io=Io,max, Tc=25°C, Vo=0.1 to 0.9*Vo,nom
Inrush Transient	---	---	0.3	A²s	
Input Reflected Ripple	---	15*	---	mApp	See input/output ripple and noise measurements figure; BW = 20 MHz
Input Ripple Rejection	---	55*	---	dB	@120Hz

*Engineering estimate

Caution: The power modules are not internally fused. An external input line normal blow fuse with a maximum value of 30A is required, see the Safety Considerations section of the data sheet.

HQA24120W480V: 48V, 2.5A Output

Characteristic	Min	Typ	Max	Unit	Notes & Conditions
Output Voltage Initial Setpoint	46.6	48	49.5	Vdc	Vin=Vin,nom; Io=Io,max; Tc = 25°C
Output Voltage Tolerance	46.1	48	49.9	Vdc	Over all rated input voltage, load, and temperature conditions to end of life
Efficiency	---	91.5	---	%	Vin=Vin,nom; Io=Io,max; Tc = 25°C
Line Regulation	---	0.05	---	%	Vin=Vin,min to Vin,max
Load Regulation	---	0.03	---	%	Io=Io,min to Io,max
Temperature Regulation	---	0.5	---	%	Tc=Tc,min to Tc,max
Output Current	0	---	2.5	A	
Output Current Limiting Threshold	---	4	---	A	Vo = 0.9*Vo,nom, Tc<Tc,max
Short Circuit Current	---	0.1	---	A	Vo = 0.25V, Tc = 25°C
Output Ripple and Noise Voltage	---	125	300*	mVpp	Measured across one 22 uF and one 0.1uF ceramic capacitor – see input/output ripple measurement figure; BW = 20MHz
	---	35	---	mVrms	
Output Voltage Adjustment Range	95	---	110	%Vo,nom	Adjustment range is reduced at input voltages below 20V
Dynamic Response: Recovery Time	---	1	---	mS	di/dt = 0.1A/uS, Vin=Vin,nom; load step from 50% to 75% of Io,max
Transient Voltage	---	300	---	mV	
Output Voltage Overshoot during startup	---	---	5	%	Vin=Vin,nom; Io=Io,max, Tc=25°C
Switching Frequency	---	270	---	kHz	Fixed
Output Over Voltage Protection	---	54	---	V	
External Load Capacitance	0	---	1000&	uF	
Isolation Capacitance	---	0.01	---	uF	
Isolation Resistance	10	---	---	MΩ	
Ra		61.9		kΩ	Required for trim calculation
Rb		6.19		kΩ	Required for trim calculation

* Engineering estimate

& Contact TDK-Lambda for applications that require additional capacitance or very low esr

Electrical Characteristics: HQA24120W480V: 48V, 2.5A Output

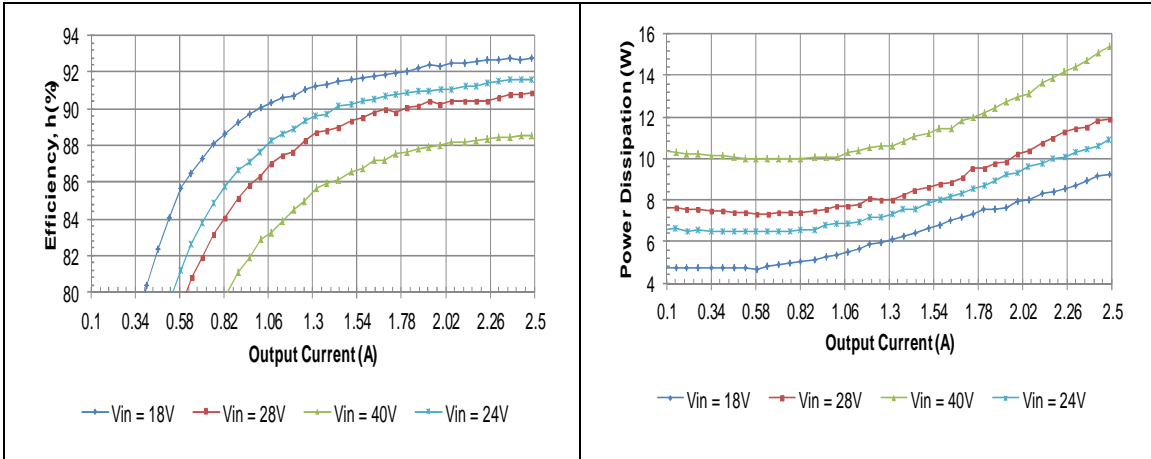

HQA24120W480V Typical Efficiency vs. Input Voltage at $T_a=25$ degrees

HQA24120W480V Typical Power Dissipation vs. Input Voltage at $T_a=25$ degrees

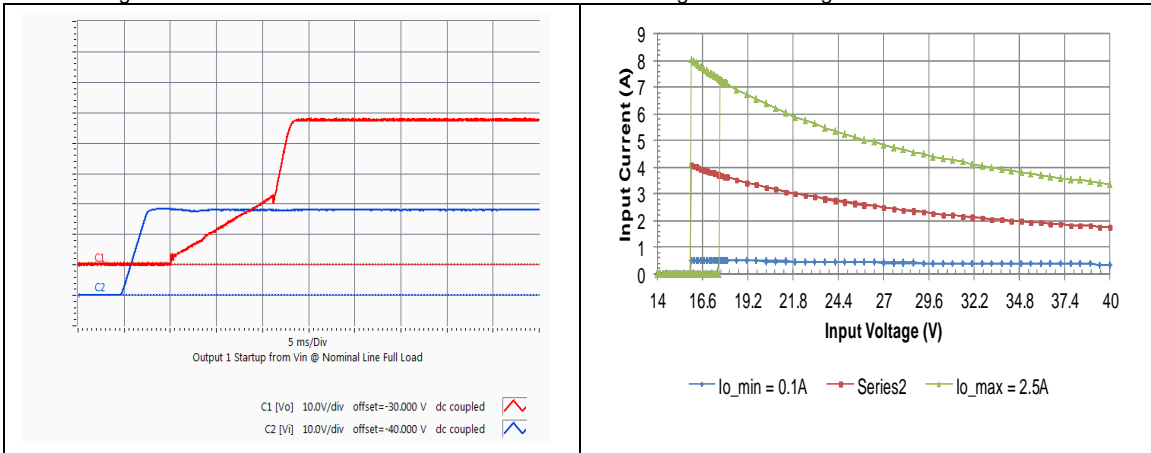

HQA24120W480V Typical startup characteristic from on/off at full load. Blue trace - on/off signal, red trace - output voltage

HQA24120W480V Typical Input Current vs. Input Voltage Characteristics

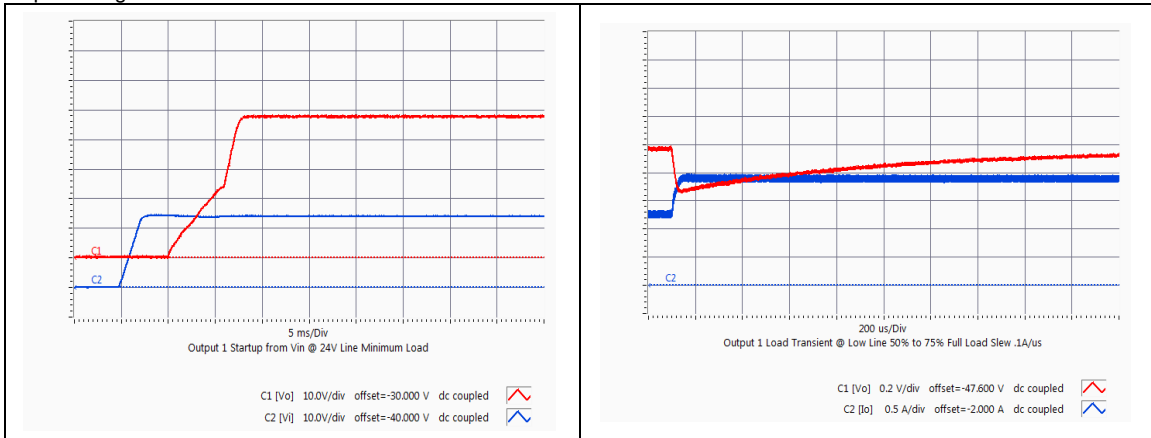

HQA24120W480V Typical startup characteristic from input voltage application at full load. Red trace - output voltage, blue trace - input voltage

HQA24120W480V Typical transient response. Output voltage response to load step from 50% to 75% of full load with output current slew rate of 0.1A/uS.

Electrical Characteristics (continued): HQA24120W480V: 48V, 2.5A Output

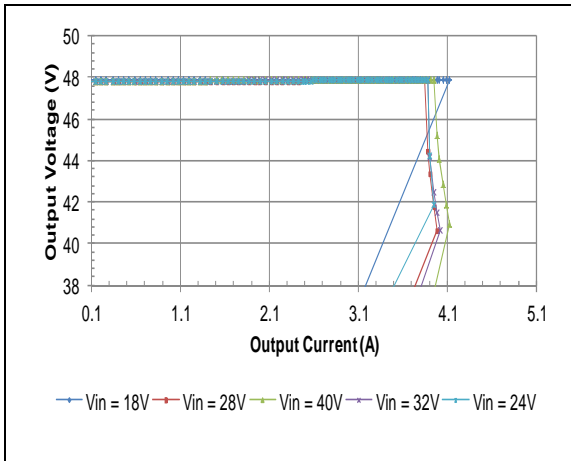

HQA24120W480V Typical Output Current Limit Characteristics vs. Input Voltage at Ta=25 degrees

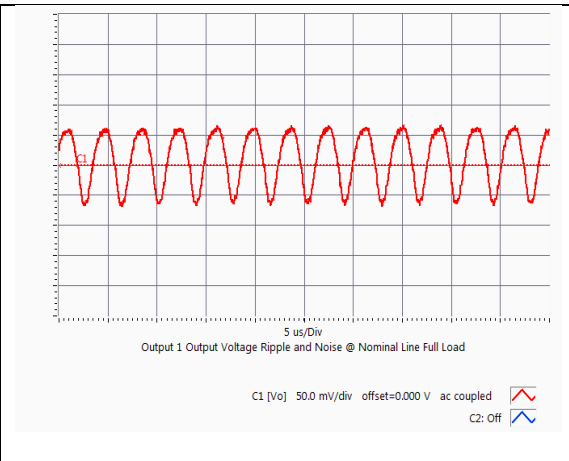

HQA24120W480V Typical Output Ripple at nominal Input voltage and full load at Ta=25 degrees

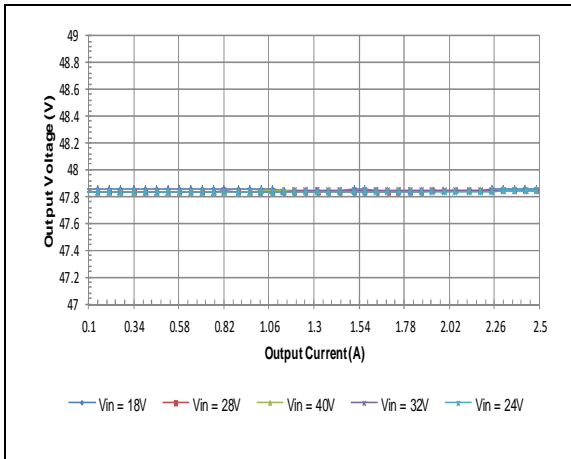

HQA24120W480V Typical Load Regulation Characteristics at Ta=25 degrees

% Change of Vout	Trim Down Resistor	% Change of Vout	Trim Up Resistor
-5%	1154K	+5%	9.3K
		+10%	1.55K

e.g. trim up 5%

$$R_{up} := \left(\frac{0.6 \cdot 61.9}{50.4 - 48} - 6.19 \right) \cdot 1000$$

HQA24120W480V Calculated resistor values for output voltage adjustment

Intentionally blank

Thermal Performance: HQA24120W480V: 48V, 2.5A Output

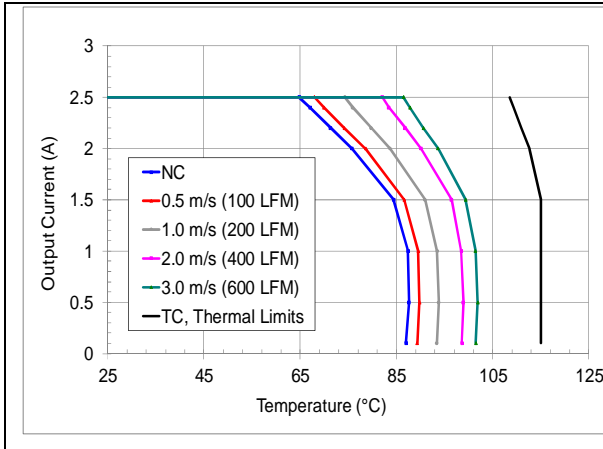

HQA24120W480V maximum output current vs. baseplate temperature

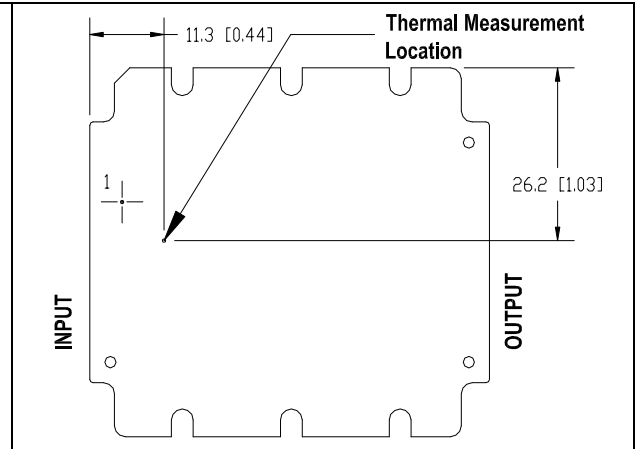

HQA2W120W280V-007 thermal measurement location – top view

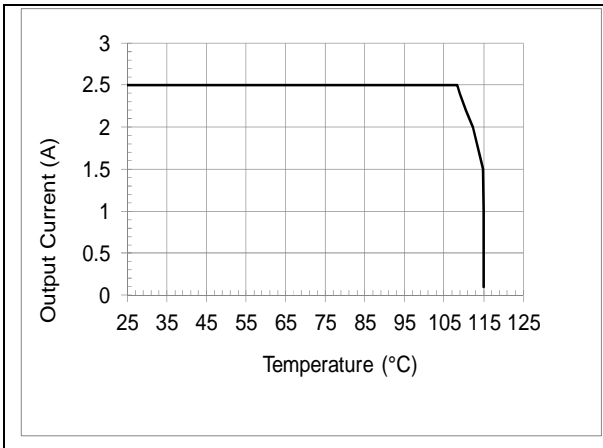

HQA24120W480V maximum output current vs. ambient temperature at 28V input for airflow rates natural convection (60lfm) to 600lfm with airflow from pin 3 to pin 1

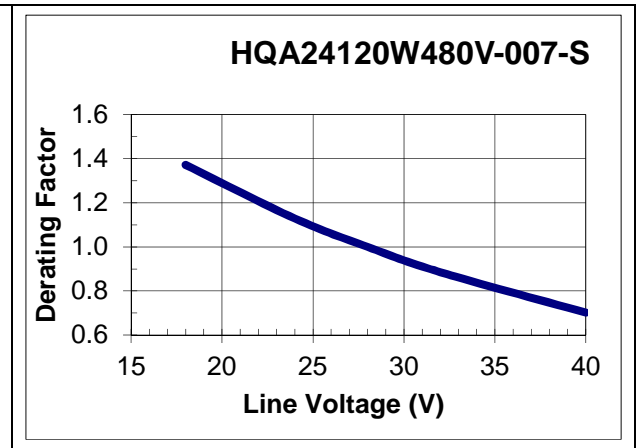

HQA24120W480V typical temperature derating versus input voltage output with 2m/s (400 lfm) airflow from pin 3 to pin 1

The thermal curves provided are based upon measurements made in TDK-Lambda's experimental test setup that is described in the Thermal Management section. Due to the large number of variables in system design, TDK-Lambda recommends that the user verify the module's thermal performance in the end application. The critical component should be thermo-coupled and monitored, and should not exceed the temperature limit specified in the derating curve above. It is critical that the thermocouple be mounted in a manner that gives direct thermal contact or significant measurement errors may result. TDK-Lambda can provide modules with a thermocouple pre-mounted to the critical component for system verification tests.

Electrical Data:

HQA2W120W280V: 28V, 4.2A Output

Characteristic	Min	Typ	Max	Unit	Notes & Conditions
Output Voltage Initial Setpoint	27.16	28	28.84	Vdc	Vin=Vin,nom; Io=Io,max; Tc = 25°C
Output Voltage Tolerance	26.88	28	29.12	Vdc	Over all rated input voltage, load, and temperature conditions to end of life
Efficiency	---	89	---	%	Vin=Vin,nom; Io=Io,max; Tc = 25°C
Line Regulation	---	0.05	---	%	Vin=Vin,min to Vin,max
Load Regulation	---	0.03	---	%	Io=Io,min to Io,max
Temperature Regulation	---	0.5	---	%	Tc=Tc,min to Tc,max
Output Current	0	---	4.2	A	
Output Current Limiting Threshold	---	5.2	---	A	Vo = 0.9*Vo,nom, Tc<Tc,max
Short Circuit Current	---	0.1	---	A	Vo = 0.25V, Tc = 25°C
Output Ripple and Noise Voltage	---	100	250*	mVpp	Measured across one 22 uF and one 0.1uF ceramic capacitor – see input/output ripple measurement figure; BW = 20MHz
	---	35	---	mVrms	
Output Voltage Adjustment Range	90	---	110	%Vo,nom	Adjustment range is reduced at input voltages below 12V
Dynamic Response: Recovery Time	---	1	---	mS	di/dt = 0.1A/uS, Vin=Vin,nom; load step from 50% to 75% of Io,max
Transient Voltage	---	400	---	mV	
Output Voltage Overshoot during startup	---	---	5	%	Vin=Vin,nom; Io=Io,max, Tc=25°C
Switching Frequency	---	270	---	kHz	Fixed
Output Over Voltage Protection	---	35	---	V	
External Load Capacitance	0	---	1000&	uF	
Isolation Capacitance	---	0.01	---	uF	
Isolation Resistance	10	---	---	MΩ	
Ra		36.5		kΩ	Required for trim calculation
Rb		3.01		kΩ	Required for trim calculation

* Engineering estimate

& Contact TDK-Lambda for applications that require additional capacitance or very low esr

Electrical Characteristics: HQA2W120W280V: 28V, 4.2A Output

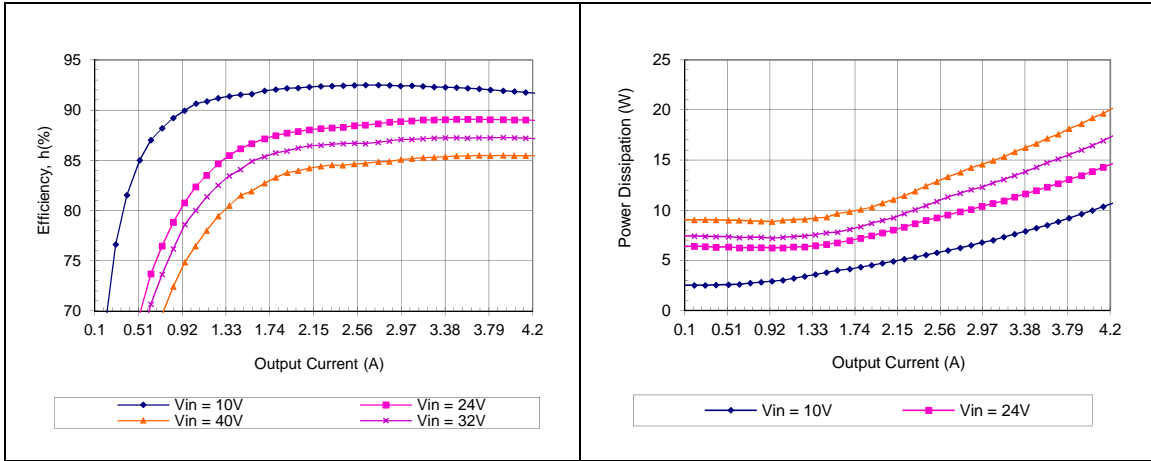

HQA2W120W280V Typical Efficiency vs. Input Voltage at Ta=25 degrees

HQA2W120W280V Typical Power Dissipation vs. Input Voltage at Ta=25 degrees

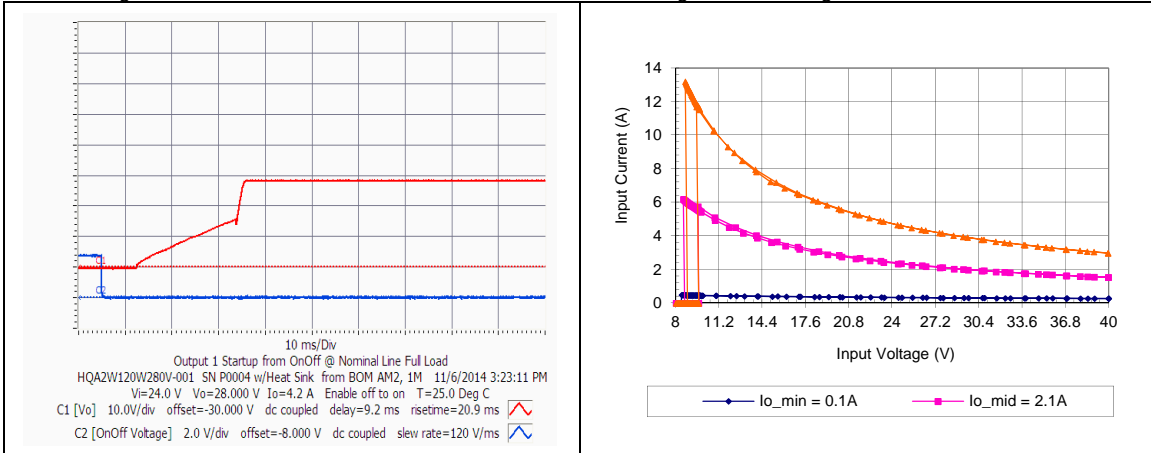

HQA2W120W280V Typical startup characteristic from on/off at full load. Blue trace - on/off signal, red trace - output voltage

HQA2W120W280V Typical Input Current vs. Input Voltage Characteristics

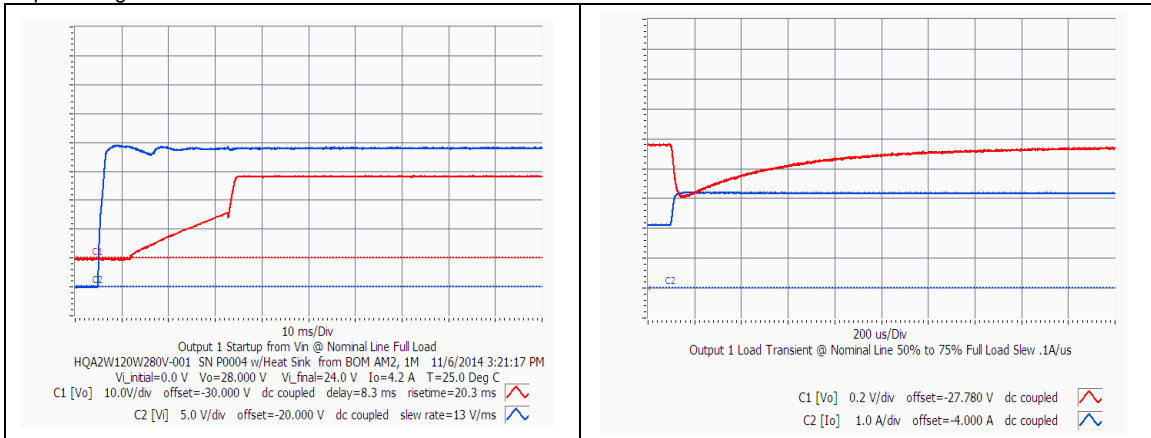

HQA2W120W280V Typical startup characteristic from input voltage application at full load. Red trace - output voltage, blue trace - input voltage

HQA2W120W280V Typical transient response. Output voltage response to load step from 50% to 75% of full load with output current slew rate of 0.1A/uS.

Electrical Characteristics (continued):

HQA2W120W280V: 28V, 4.2A Output

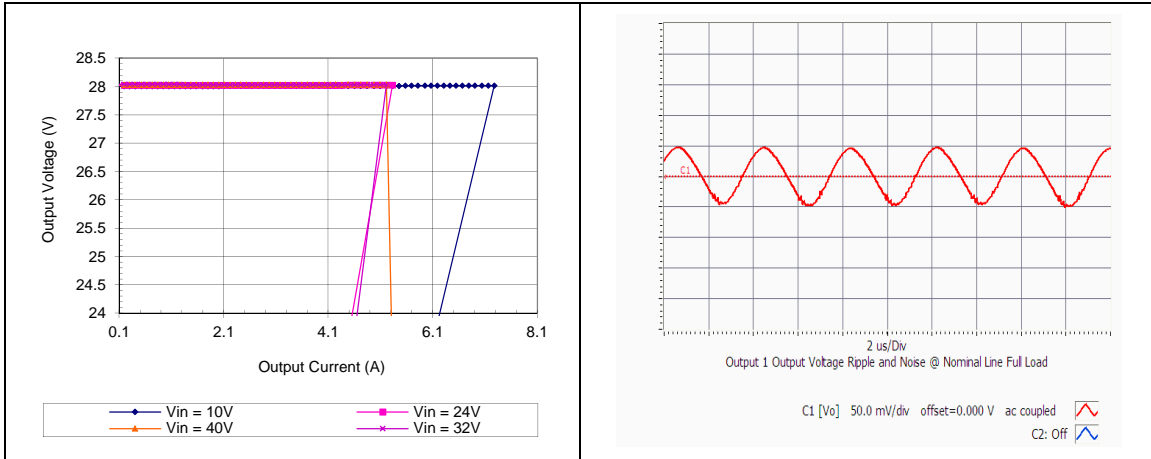

HQA2W120W280V Typical Output Current Limit Characteristics vs. Input Voltage at Ta=25 degrees

HQA2W120W280V Typical Output Ripple at nominal Input voltage and full load at Ta=25 degrees

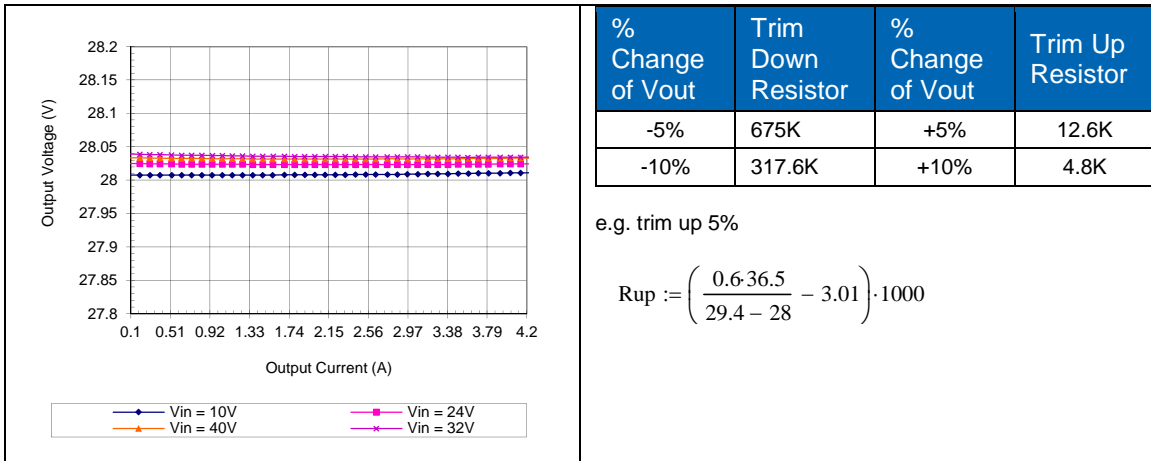

HQA2W120W280V Typical Load Regulation Characteristics at Ta=25 degrees

HQA2W120W280V Calculated resistor values for output voltage adjustment

Intentionally blank

Thermal Performance:

HQA2W120W280V-007: 28V, 4.2A Output

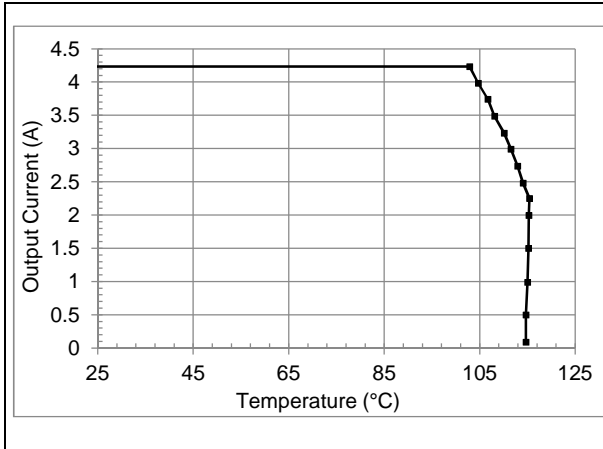

HQA2W120W280V maximum output current vs. baseplate temperature

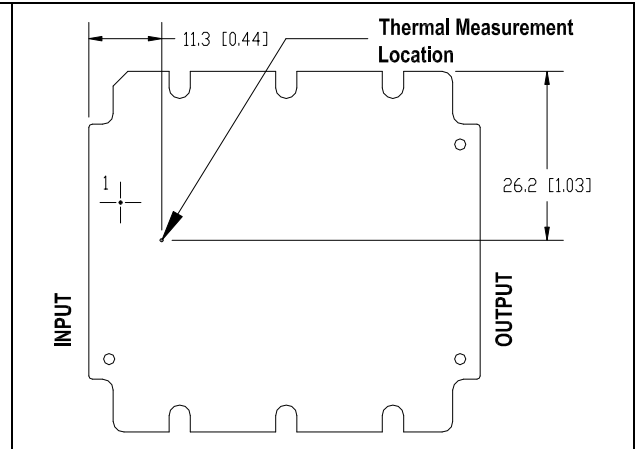

HQA2W120W280V-007 thermal measurement location – top view

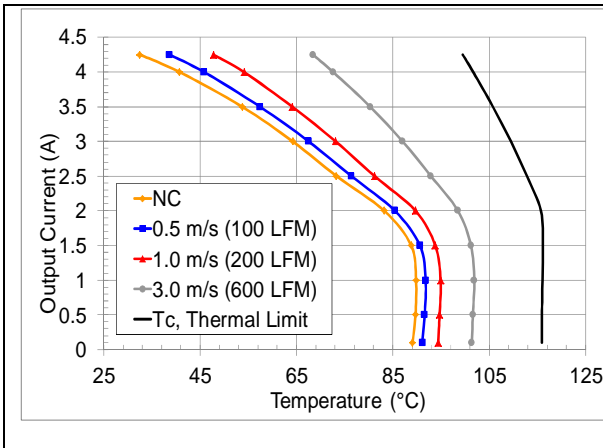

HQA2W120W280V maximum output current vs. ambient temperature at 28V input for airflow rates natural convection (60lfm) to 600lfm with airflow from pin 3 to pin 1

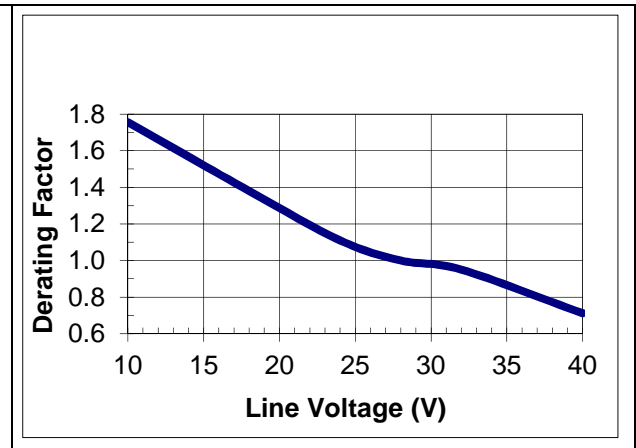

HQA2W120W280V typical temperature derating versus input voltage output with 2m/s (400 lfm) airflow from pin 3 to pin 1

The thermal curves provided are based upon measurements made in TDK-Lambda's experimental test setup that is described in the Thermal Management section. Due to the large number of variables in system design, TDK-Lambda recommends that the user verify the module's thermal performance in the end application. The critical component should be thermo-coupled and monitored, and should not exceed the temperature limit specified in the derating curve above. It is critical that the thermocouple be mounted in a manner that gives direct thermal contact or significant measurement errors may result. TDK-Lambda can provide modules with a thermocouple pre-mounted to the critical component for system verification tests.

HQA2W120W240V: 24V, 5A Output

Characteristic	Min	Typ	Max	Unit	Notes & Conditions
Output Voltage Initial Setpoint	23.28	24	24.72	Vdc	Vin=Vin,nom; Io=Io,max; Tc = 25°C
Output Voltage Tolerance	23.04	24	24.96	Vdc	Over all rated input voltage, load, and temperature conditions to end of life
Efficiency	---	87	---	%	Vin=Vin,nom; Io=Io,max; Tc = 25°C
Line Regulation	---	0.05	---	%	Vin=Vin,min to Vin,max
Load Regulation	---	0.03	---	%	Io=Io,min to Io,max
Temperature Regulation	---	0.5	---	%	Tc=Tc,min to Tc,max
Output Current	0	---	5	A	
Output Current Limiting Threshold	---	6.2	---	A	Vo = 0.9*Vo,nom, Tc<Tc,max
Short Circuit Current	---	0.1	---	A	Vo = 0.25V, Tc = 25°C
Output Ripple and Noise Voltage	---	100	250*	mVpp	Measured across one 22 uF and one 0.1uF ceramic capacitor – see input/output ripple measurement figure; BW = 20MHz
	---	35	---	mVrms	
Output Voltage Adjustment Range	90	---	110	%Vo,nom	Adjustment range is reduced at input voltages below 12V
Dynamic Response: Recovery Time	---	1	---	mS	di/dt = 0.1A/uS, Vin=Vin,nom; load step from 50% to 75% of Io,max
Transient Voltage	---	400	---	mV	
Output Voltage Overshoot during startup	---	---	5	%	Vin=Vin,nom; Io=Io,max, Tc=25°C
Switching Frequency	---	270	---	kHz	Fixed
Output Over Voltage Protection	---	32	---	V	
External Load Capacitance	0	---	1000&	uF	
Isolation Capacitance	---	0.01	---	uF	
Isolation Resistance	10	---	---	MΩ	
Ra		36.5		kΩ	Required for trim calculation
Rb		3.01		kΩ	Required for trim calculation

* Engineering estimate

& Contact TDK-Lambda for applications that require additional capacitance or very low esr

Electrical Characteristics: HQA2W120W240V: 24V, 5A Output

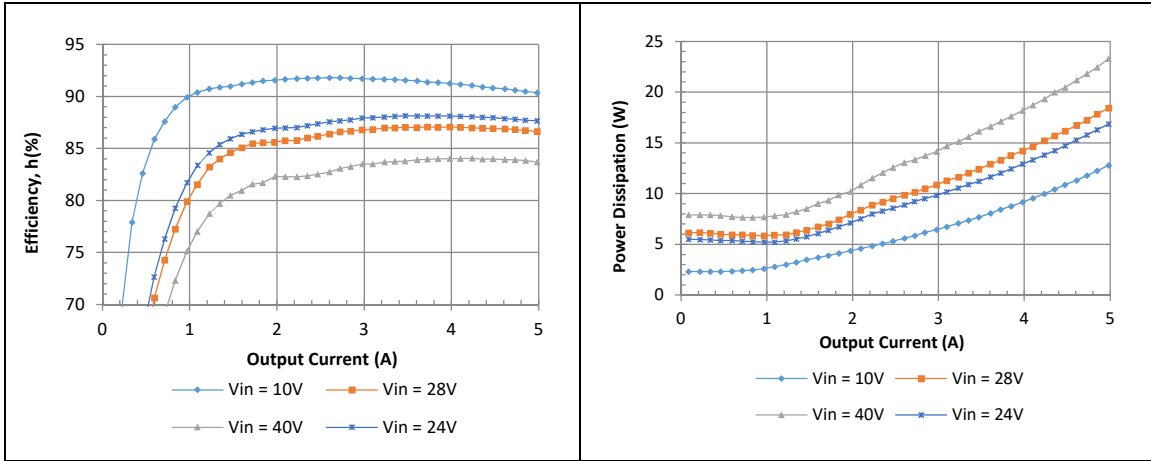

HQA2W120W240V Typical Efficiency vs. Input Voltage at Ta=25 degrees

HQA2W120W240V Typical Power Dissipation vs. Input Voltage at Ta=25 degrees

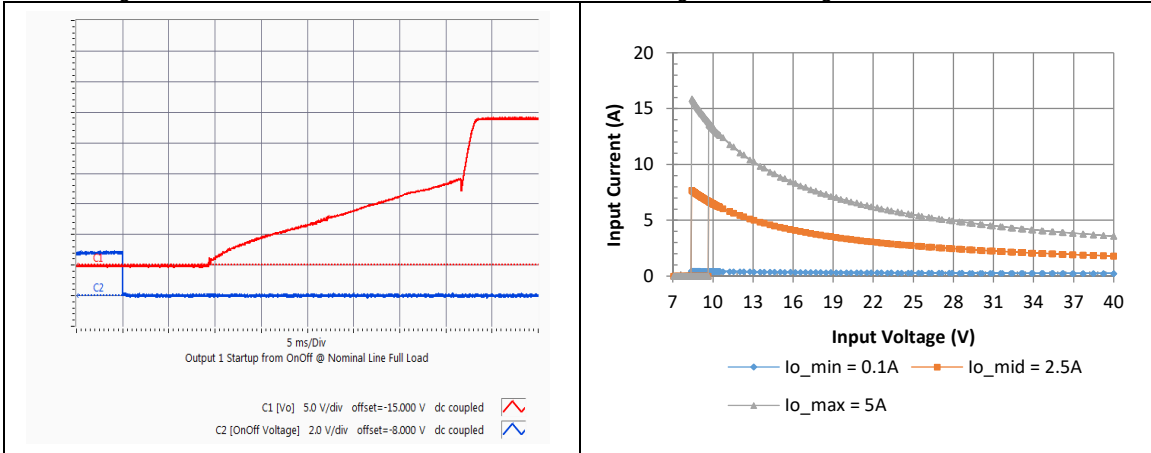

HQA2W120W240V Typical startup characteristic from on/off at full load. Blue trace - on/off signal, red trace - output voltage

HQA2W120W240V Typical Input Current vs. Input Voltage Characteristics

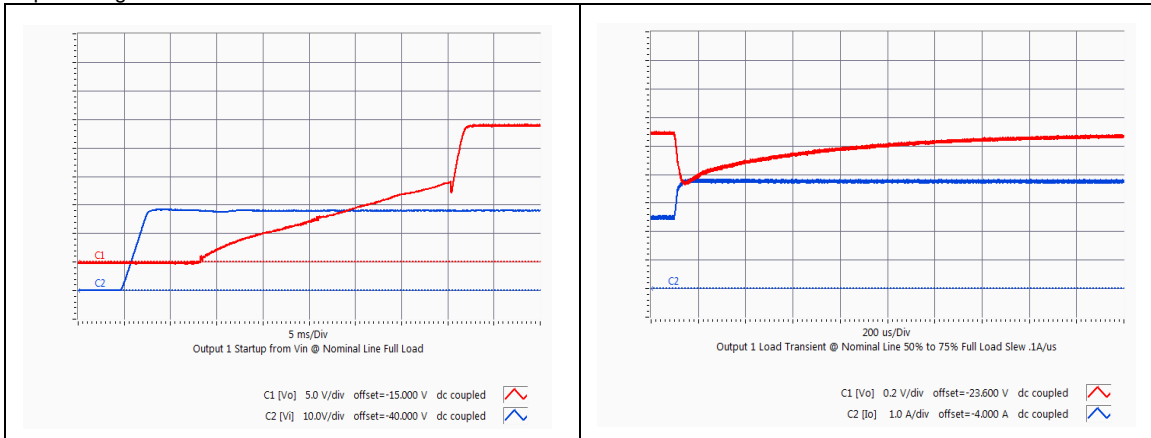

HQA2W120W240V Typical startup characteristic from input voltage application at full load. Red trace - output voltage, blue trace - input voltage

HQA2W120W240V Typical transient response. Output voltage response to load step from 50% to 75% of full load with output current slew rate of 0.1A/uS.

Electrical Characteristics (continued):

HQA2W120W240V: 24V, 5A Output

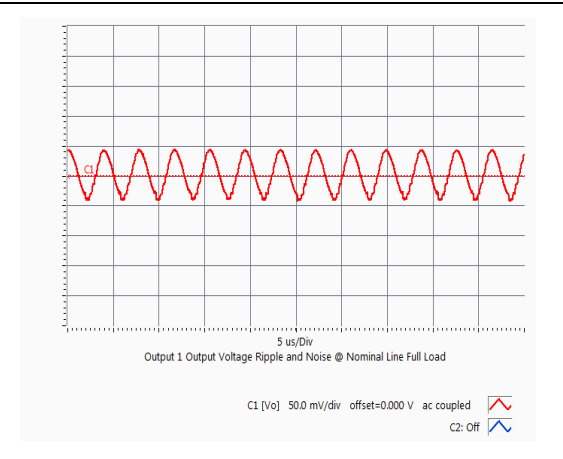
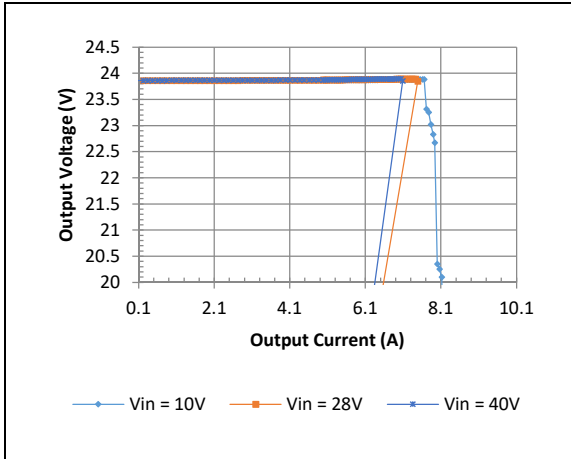

HQA2W120W240V Typical Output Current Limit Characteristics vs. Input Voltage at Ta=25 degrees

HQA2W120W240V Typical Output Ripple at nominal Input voltage and full load at Ta=25 degrees

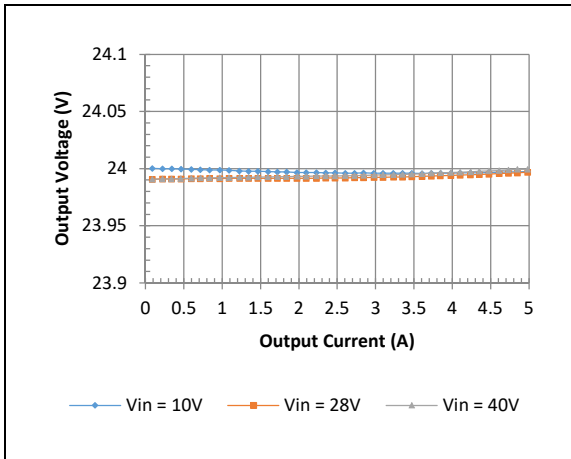

% Change of Vout	Trim Down Resistor	% Change of Vout	Trim Up Resistor
-5%	675K	+5%	12.6K
-10%	317.6K	+10%	4.8K

e.g. trim up 5%

$$R_{up} := \left(\frac{0.6 - 36.5}{29.4 - 28} - 3.01 \right) \cdot 1000$$

HQA2W120W240V Typical Load Regulation Characteristics at Ta=25 degrees

HQA2W120W280V Calculated resistor values for output voltage adjustment

Intentionally blank

Thermal Performance: HQA2W120W240V: 24V, 5A Output

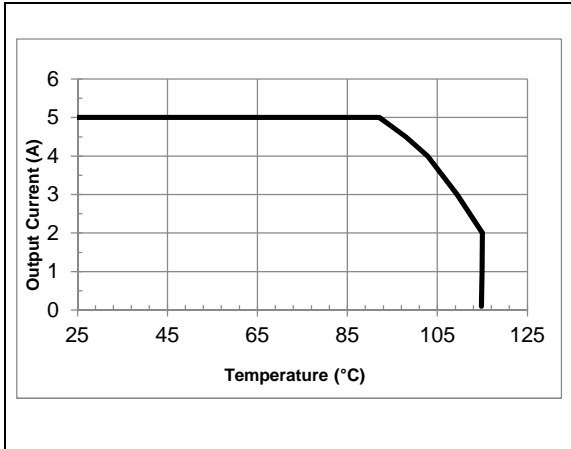

HQA2W120W240V maximum output current vs. baseplate temperature at nominal line

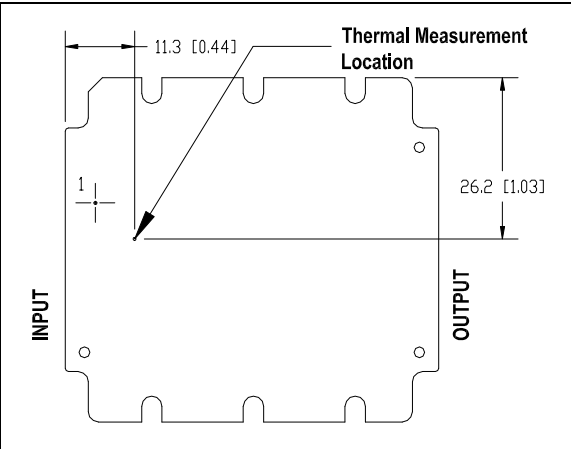

HQA2W120W240V-007 thermal measurement location – top view

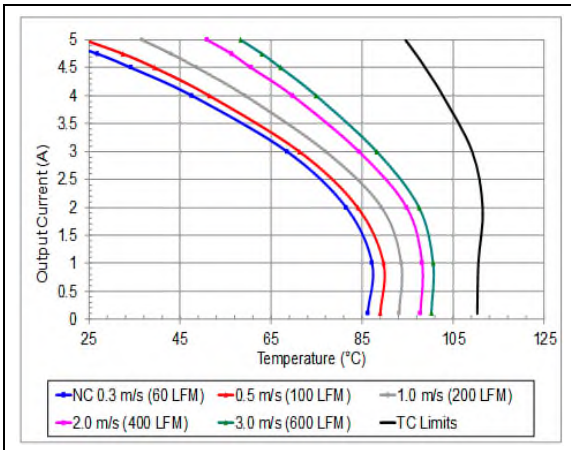

HQA2W120W240V maximum output current vs. ambient temperature at 28V input for airflow rates natural convection (60lfm) to 600lfm with airflow from pin 3 to pin 1

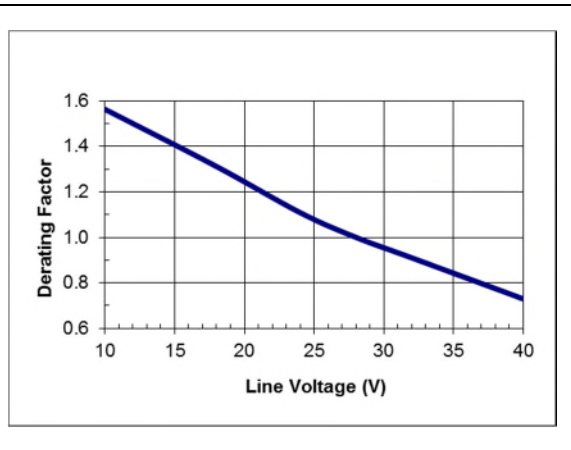

HQA2W120W240V typical temperature derating versus input voltage output with 2m/s (400 lfm) airflow from pin 3 to pin 1

The thermal curves provided are based upon measurements made in TDK-Lambda's experimental test setup that is described in the Thermal Management section. Due to the large number of variables in system design, TDK-Lambda recommends that the user verify the module's thermal performance in the end application. The critical component should be thermo-coupled and monitored, and should not exceed the temperature limit specified in the derating curve above. It is critical that the thermocouple be mounted in a manner that gives direct thermal contact or significant measurement errors may result. TDK-Lambda can provide modules with a thermocouple pre-mounted to the critical component for system verification tests.

Electrical Data:

HQA2W120W150V: 15V, 8A Output

Characteristic	Min	Typ	Max	Unit	Notes & Conditions
Output Voltage Initial Setpoint	14.55	15	15.45	Vdc	Vin=Vin,nom; Io=Io,max; Tc = 25°C
Output Voltage Tolerance	14.4	15	15.6	Vdc	Over all rated input voltage, load, and temperature conditions to end of life
Efficiency	---	89	---	%	Vin=Vin,nom; Io=Io,max; Tc = 25°C
Line Regulation	---	0.05	---	%	Vin=Vin,min to Vin,max
Load Regulation	---	0.03	---	%	Io=Io,min to Io,max
Temperature Regulation	---	0.5	---	%	Tc=Tc,min to Tc,max
Output Current	0	---	8	A	At loads less than Io,min the module will continue to regulate the output voltage, but the output ripple may increase
Output Current Limiting Threshold	---	12	---	A	Vo = 0.9*Vo,nom, Tc<Tc,max
Short Circuit Current	---	0.1	---	A	Vo = 0.25V, Tc = 25°C
Output Ripple and Noise Voltage	---	100	200*	mVpp	Measured across one 22 uF and one 0.1uF ceramic capacitor – see input/output ripple measurement figure; BW = 20MHz
	---	10	---	mVrms	
Output Voltage Adjustment Range	90	---	110	%Vo,nom	Adjustment range is reduced at input voltages below 12V
Output Voltage Sense Range	---	---	10	%Vo,nom	
Dynamic Response: Recovery Time	---	0.6	---	mS	di/dt = 0.1A/uS, Vin=Vin,nom; load step from 50% to 75% of Io,max
Transient Voltage	---	240*	---	mV	
Output Voltage Overshoot during startup	---	---	5	%	Vin=Vin,nom; Io=Io,max, Tc=25°C
Switching Frequency	---	270	---	kHz	Fixed
Output Over Voltage Protection	---	18	---	V	
External Load Capacitance	0	---	1500&	uF	
Isolation Capacitance	---	0.01	---	uF	
Isolation Resistance	10	---	---	MΩ	
Ra		36.5		KΩ	Required for trim calculation
Rb		10		KΩ	Required for trim calculation

* Engineering estimate

& Contact TDK-Lambda for applications that require additional capacitance or very low esr

Electrical Characteristics: HQA2W120W150V: 15V, 8A Output

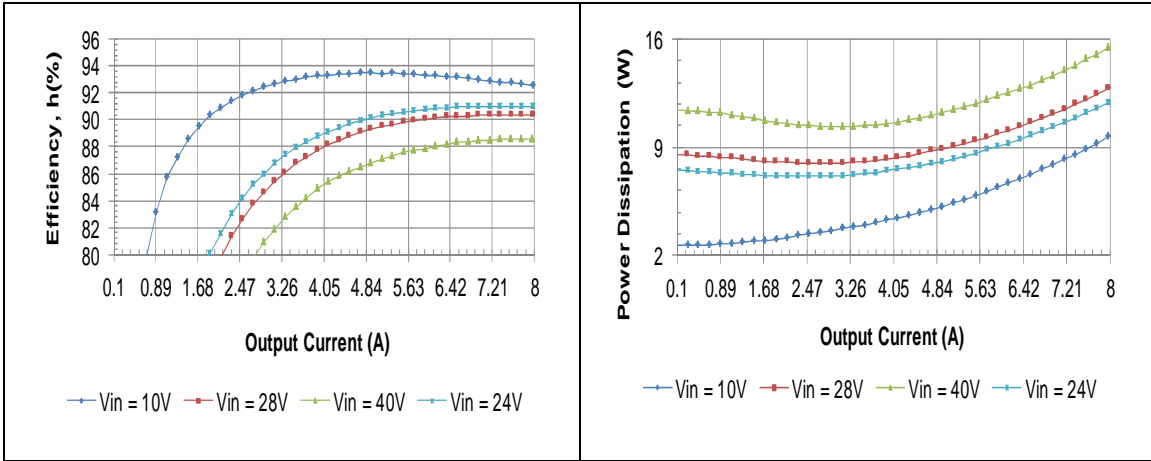

HQA2W120W150V Typical Efficiency vs. Input Voltage at Ta=25 degrees

HQA2W120W150V Typical Power Dissipation vs. Input Voltage at Ta=25 degrees

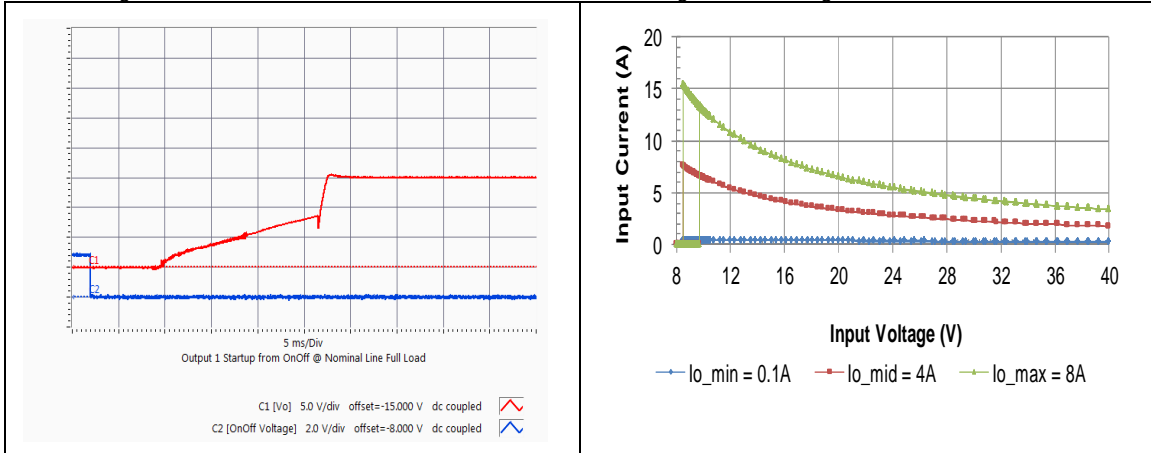

HQA2W120W150V Typical startup characteristic from on/off at full load. Lower trace - on/off signal, upper trace - output voltage

HQA2W120W150V Typical Input Current vs. Input Voltage Characteristics

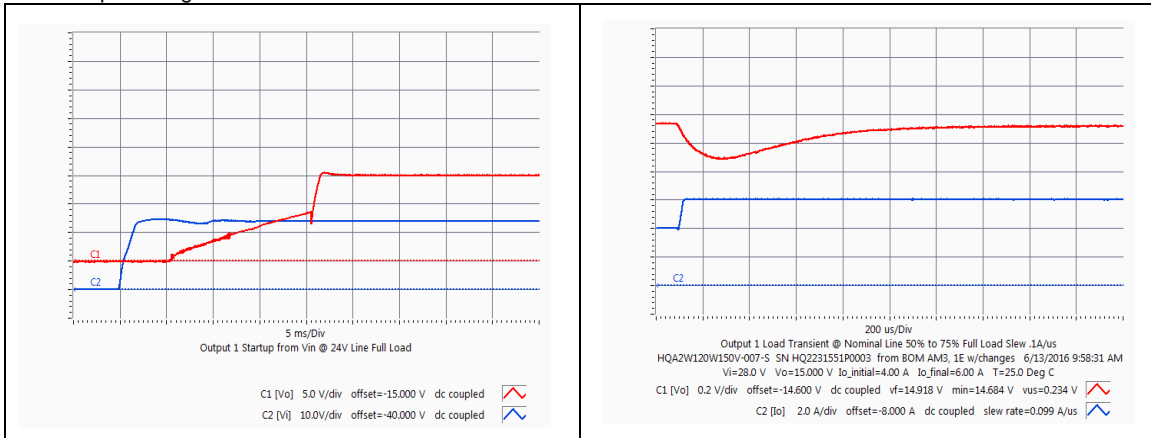

HQA2W120W150V Typical startup characteristic from input voltage application at full load. Red trace - output voltage, Blue trace - input voltage

HQA2W120W150V Typical output voltage response to load step from 50% to 75% of full load with output current slew rate of 0.1A/uS and Cext = 500uF

Electrical Characteristics (continued): HQA2W120W150V: 15V, 8A Output

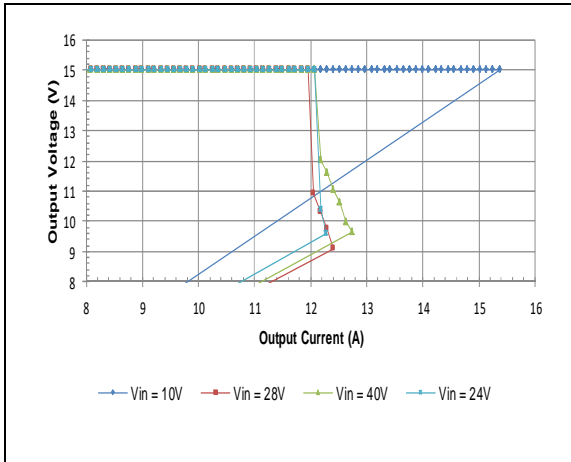

HQA2W120W150V Typical Output Current Limit Characteristics vs. Input Voltage at Ta=25 degrees

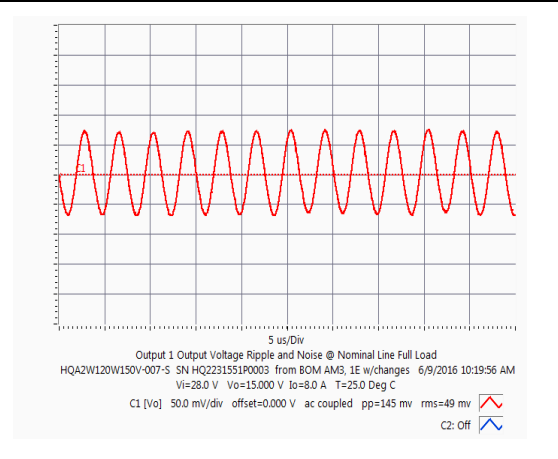

HQA2W120W150V Typical Output Ripple at nominal Input voltage and full load at Ta=25 degrees

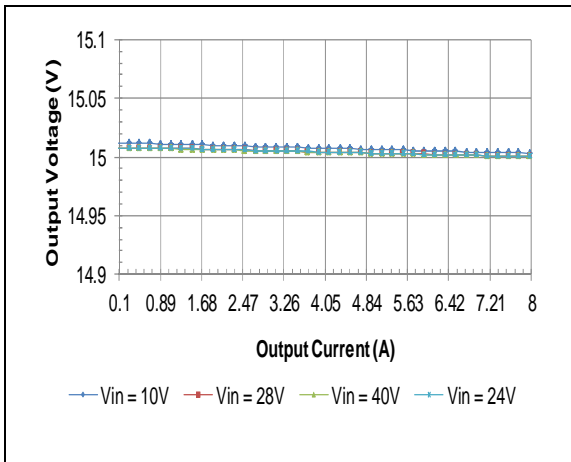

HQA2W120W150V Typical Load Regulation Characteristics at Ta=25 degrees

% Change of Vout	Trim Down Resistor	% Change of Vout	Trim Up Resistor
-5%	654K	+5%	19.2K
-10%	304K	+10%	4.6K

e.g. trim up 5%

$$R_{up} := \left(\frac{0.6 \cdot 36.5}{15.75 - 15} - 10 \right) \cdot 1000$$

Intentionally blank

HQA2W120W150V Calculated resistor values for output voltage adjustment

Thermal Performance: HQA2W120W150V: 15V, 8A Output

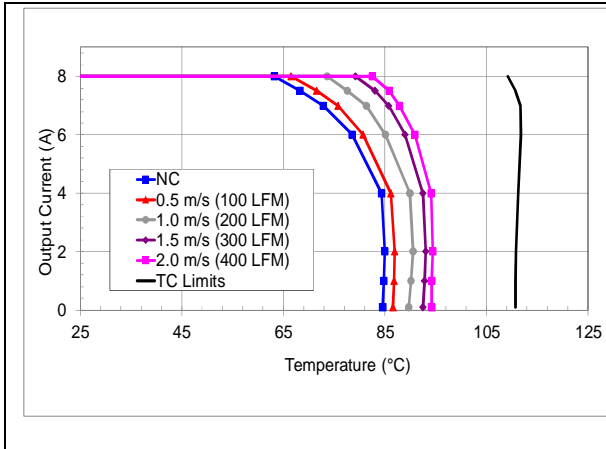

HQA2W120W150V maximum output current vs. ambient temperature at 28V input for airflow rates natural convection (60lfm) to 600lfm with airflow from pin 3 to pin 1

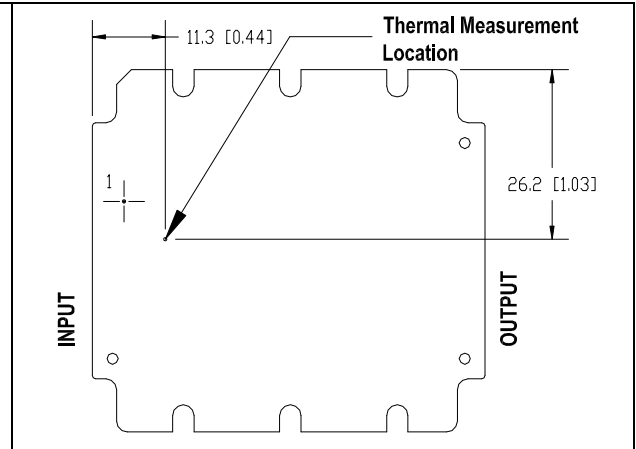

HQA2W120W150V thermal measurement location – top view

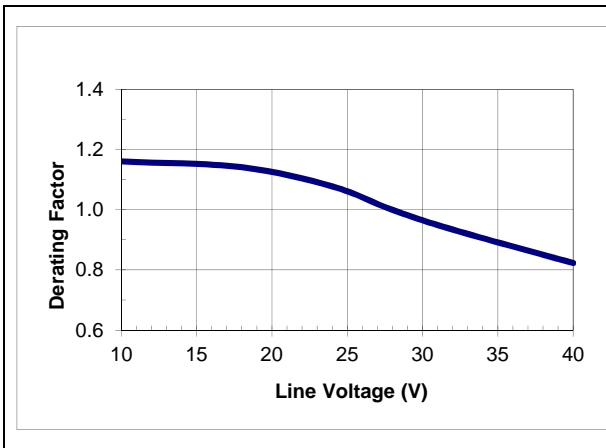

HQA2W120W150V typical temperature derating versus input voltage output with 2m/s (400 lfm) airflow from pin 3 to pin 1

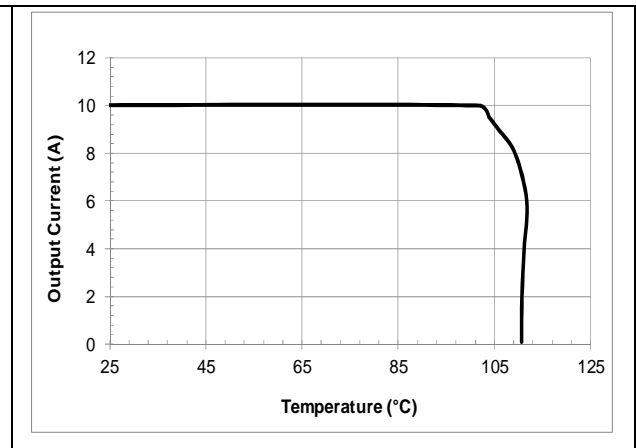

HQA2W120W150V maximum output current vs. baseplate temperature at nominal line

The thermal curves provided are based upon measurements made in TDK-Lambda's experimental test setup that is described in the Thermal Management section. Due to the large number of variables in system design, TDK-Lambda recommends that the user verify the module's thermal performance in the end application. The critical component should be thermo coupled and monitored, and should not exceed the temperature limit specified in the derating curve above. It is critical that the thermocouple be mounted in a manner that gives direct thermal contact or significant measurement errors may result. TDK-Lambda can provide modules with a thermocouple pre-mounted to the critical component for system verification tests.

Electrical Data:

HQA2W120W120V: 12V, 10A Output

Characteristic	Min	Typ	Max	Unit	Notes & Conditions
Output Voltage Initial Setpoint	11.64	12	12.36	Vdc	Vin=Vin,nom; Io=Io,max; Tc = 25°C
Output Voltage Tolerance	11.54	12	12.48	Vdc	Over all rated input voltage, load, and temperature conditions to end of life
Efficiency	---	89	---	%	Vin=Vin,nom; Io=Io,max; Tc = 25°C
Line Regulation	---	0.05	---	%	Vin=Vin,min to Vin,max
Load Regulation	---	0.03	---	%	Io=Io,min to Io,max
Temperature Regulation	---	0.5	---	%	Tc=Tc,min to Tc,max
Output Current	0	---	10	A	At loads less than Io,min the module will continue to regulate the output voltage, but the output ripple may increase
Output Current Limiting Threshold	---	14.5	---	A	Vo = 0.9*Vo,nom, Tc<Tc,max
Short Circuit Current	---	0.1	---	A	Vo = 0.25V, Tc = 25°C
Output Ripple and Noise Voltage	---	40	180*	mVpp	Measured across one 22 uF and one 0.1uF ceramic capacitor – see input/output ripple measurement figure; BW = 20MHz
	---	10	---	mVrms	
Output Voltage Adjustment Range	90	---	110	%Vo,nom	Adjustment range is reduced at input voltages below 12V
Output Voltage Sense Range	---	---	10	%Vo,nom	
Dynamic Response: Recovery Time	---	0.8	---	mS	di/dt = 0.1A/uS, Vin=Vin,nom; load step from 50% to 75% of Io,max
Transient Voltage	---	120*	---	mV	
Output Voltage Overshoot during startup	---	---	5	%	Vin=Vin,nom; Io=Io,max, Tc=25°C
Switching Frequency	---	270	---	kHz	Fixed
Output Over Voltage Protection	---	15	---	V	
External Load Capacitance	0	---	1800&	uF	
Isolation Capacitance	---	0.01	---	uF	
Isolation Resistance	10	---	---	MΩ	
Ra		36.5		KΩ	Required for trim calculation
Rb		10		KΩ	Required for trim calculation

* Engineering estimate

& Contact TDK-Lambda for applications that require additional capacitance or very low esr

Electrical Characteristics: HQA2W120W120V: 12V, 10A Output

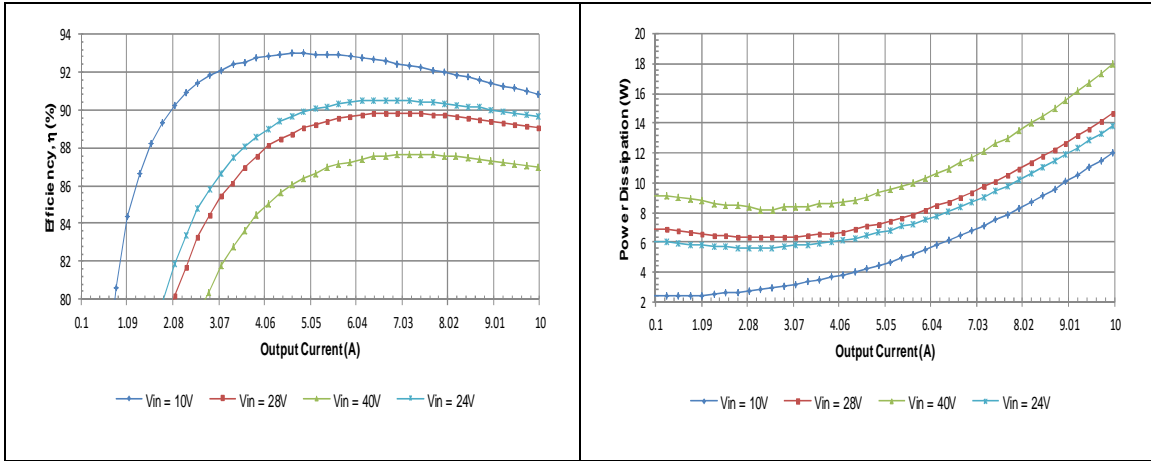

HQA2W120W120V Typical Efficiency vs. Input Voltage at $T_a=25$ degrees

HQA2W120W120V Typical Power Dissipation vs. Input Voltage at $T_a=25$ degrees

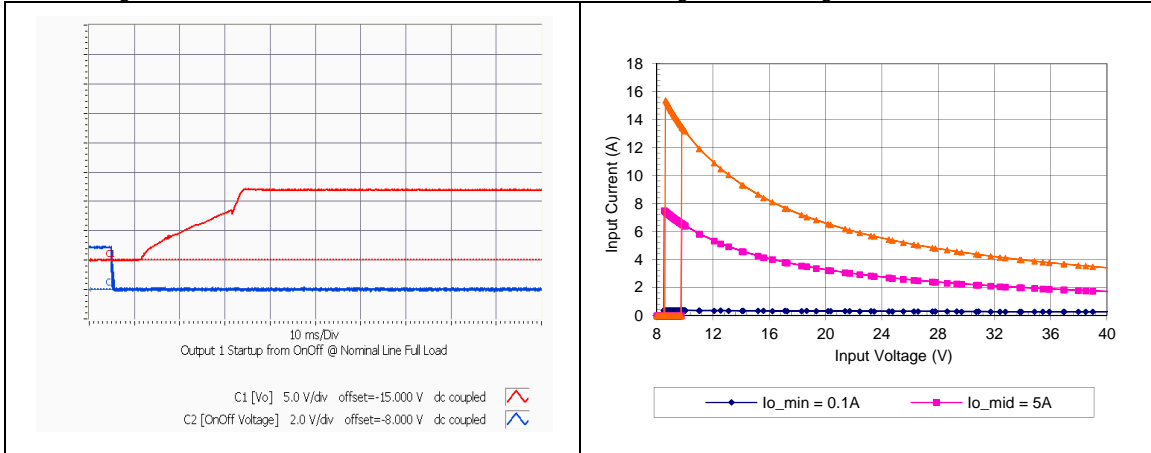

HQA2W120W120V Typical startup characteristic from on/off at full load. Lower trace - on/off signal, upper trace - output voltage

HQA2W120W120V Typical Input Current vs. Input Voltage Characteristics

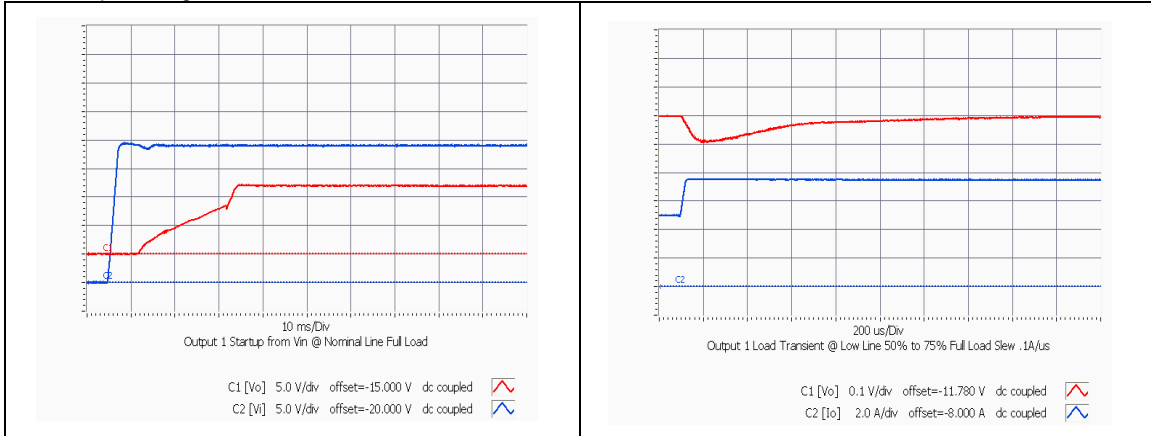

HQA2W120W120V Typical startup characteristic from input voltage application at full load. Red trace - output voltage, Blue trace - input voltage

HQA2W120W120V Typical output voltage response to load step from 50% to 75% of full load with output current slew rate of 0.1A/ μs and $C_{ext} = 500\mu F$

Electrical Characteristics (continued):

HQA2W120W120V: 12V, 10A Output

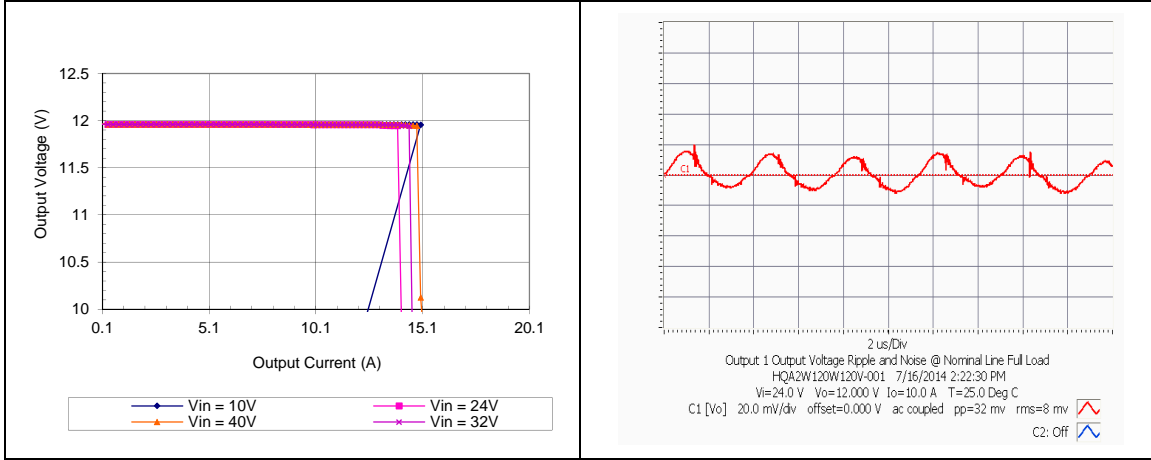

HQA2W120W120V Typical Output Current Limit Characteristics vs. Input Voltage at Ta=25 degrees

HQA2W120W120V Typical Output Ripple at nominal Input voltage and full load at Ta=25 degrees

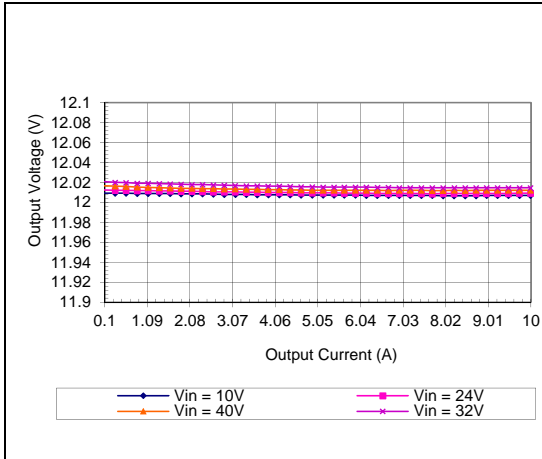

% Change of Vout	Trim Down Resistor	% Change of Vout	Trim Up Resistor
-5%	647K	+5%	26.5K
-10%	300K	+10%	8.25K

e.g. trim up 5%

$$R_{up} := \left(\frac{0.6 \cdot 36.5}{12.6 - 12} - 10 \right) \cdot 1000$$

HQA2W120W120V Typical Load Regulation Characteristics at Ta=25 degrees

HQA2W120W120V Calculated resistor values for output voltage adjustment

Intentionally blank

Thermal Performance:

HQA2W120W120V-007: 12V, 10A Output

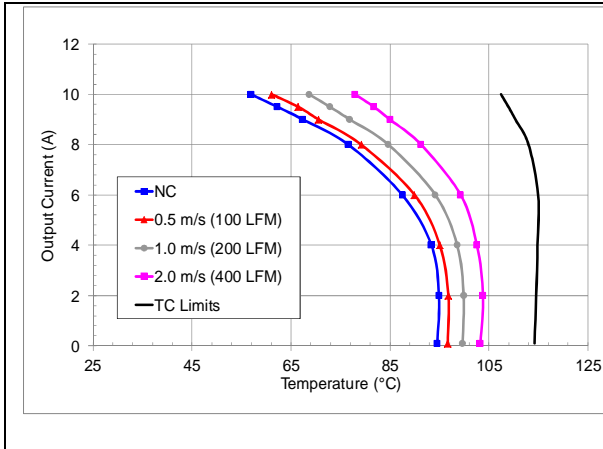

HQA2W120W120V maximum output current vs. ambient temperature at 28V input for airflow rates natural convection (60lfm) to 600lfm with airflow from pin 3 to pin 1

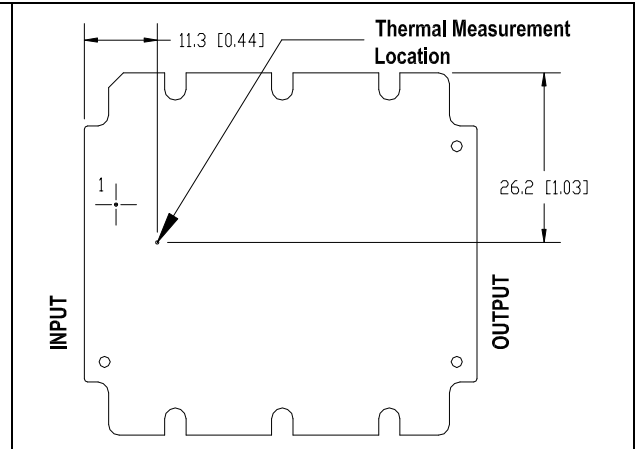

HQA2W120W120V thermal measurement location – top view

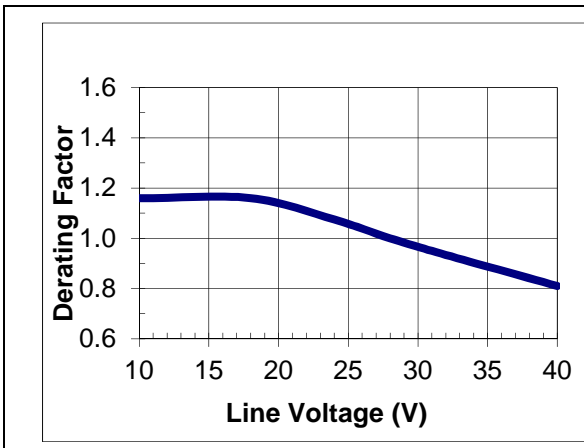

HQA2W120W120V typical temperature derating versus input voltage output with 2m/s (400 lfm) airflow from pin 3 to pin 1

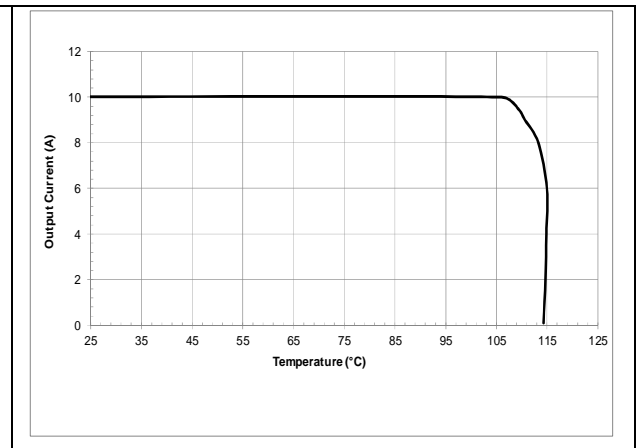

HQA2W120W120V maximum output current vs. baseplate temperature at nominal line

The thermal curves provided are based upon measurements made in TDK-Lambda's experimental test setup that is described in the Thermal Management section. Due to the large number of variables in system design, TDK-Lambda recommends that the user verify the module's thermal performance in the end application. The critical component should be thermo coupled and monitored, and should not exceed the temperature limit specified in the derating curve above. It is critical that the thermocouple be mounted in a manner that gives direct thermal contact or significant measurement errors may result. TDK-Lambda can provide modules with a thermocouple pre-mounted to the critical component for system verification tests.

Electrical Data:

HQA2W120W050V: 5V, 24A Output

Characteristic	Min	Typ	Max	Unit	Notes & Conditions
Output Voltage Initial Setpoint	4.85	5	5.15	Vdc	Vin=Vin,nom; Io=Io,max; Tc = 25°C
Output Voltage Tolerance	4.8	5	5.2	Vdc	Over all rated input voltage, load, and temperature conditions to end of life
Efficiency	---	90	---	%	Vin=Vin,nom; Io=Io,max; Tc = 25°C
Line Regulation	---	0.05	---	%	Vin=Vin,min to Vin,max
Load Regulation	---	0.03	---	%	Io=Io,min to Io,max
Temperature Regulation	---	0.5	---	%	Tc=Tc,min to Tc,max
Output Current	0.1	---	24	A	At loads less than Io,min the module will continue to regulate the output voltage, but the output ripple may increase
Output Current Limiting Threshold	---	37	---	A	Vo = 0.9*Vo,nom, Tc<Tc,max
Short Circuit Current	---	0.3	---	A	Vo = 0.25V, Tc = 25°C
Output Ripple and Noise Voltage	---	40	150*	mVpp	Measured across one 22 uF and one 0.1uF ceramic capacitor – see input/output ripple measurement figure; BW = 20MHz
	---	15	---	mVrms	
Output Voltage Adjustment Range	90	---	110	%Vo,nom	Adjustment range is reduced at input voltages below 12V
Output Voltage Sense Range	---	---	10	%Vo,nom	
Dynamic Response: Recovery Time	---	0.8	---	mS	di/dt = 0.1A/uS, Vin=Vin,nom; load step from 50% to 75% of Io,max
Transient Voltage	---	120*	---	mV	
Output Voltage Overshoot during startup	---	---	5	%	Vin=Vin,nom; Io=Io,max, Tc=25°C
Switching Frequency	---	270	---	kHz	Fixed
Output Over Voltage Protection	---	6.5	---	V	
External Load Capacitance	22	---	2400&	uF	
Isolation Capacitance	---	0.01	---	uF	
Isolation Resistance	10	---	---	MΩ	
Ra		10		KΩ	Required for trim calculation
Rb		4.22		KΩ	Required for trim calculation

* Engineering estimate

& Contact TDK-Lambda for applications that require additional capacitance or very low esr

Electrical Characteristics: HQA2W120W050V: 5V, 24A Output

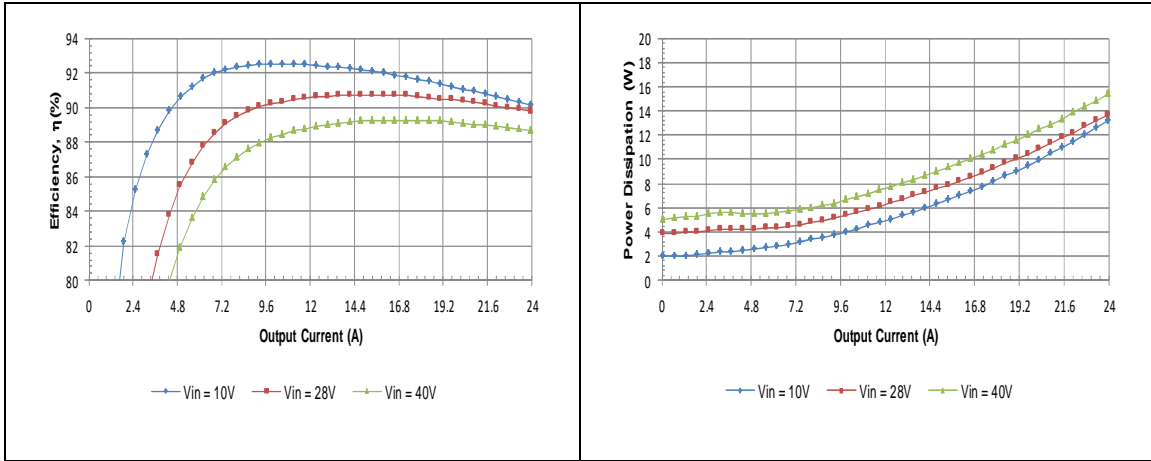

HQA2W120W050V Typical Efficiency vs. Input Voltage at $T_a=25$ degrees

HQA2W120W050V Typical Power Dissipation vs. Input Voltage at $T_a=25$ degrees

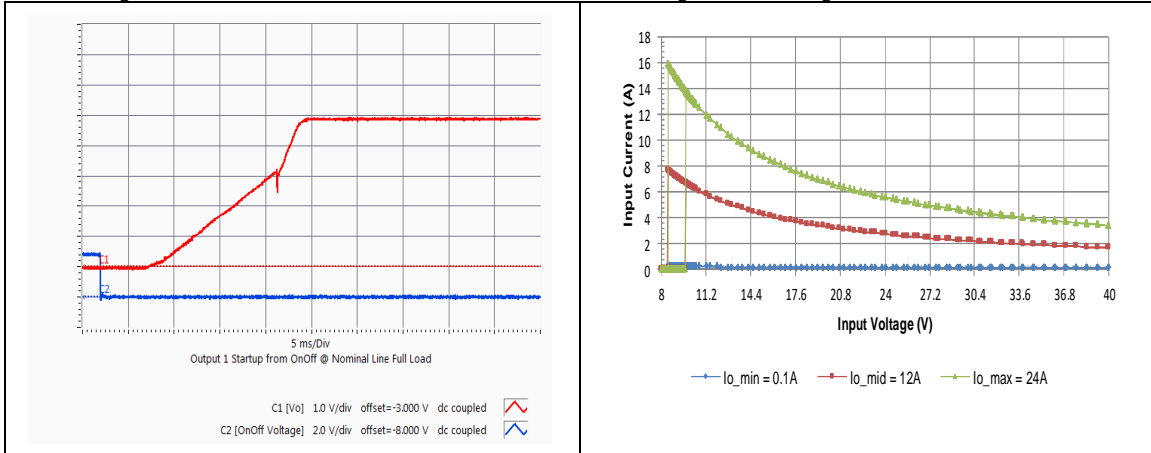

HQA2W120W050V Typical startup characteristic from on/off at full load. Lower trace - on/off signal, upper trace - output voltage

HQA2W120W050V Typical Input Current vs. Input Voltage Characteristics

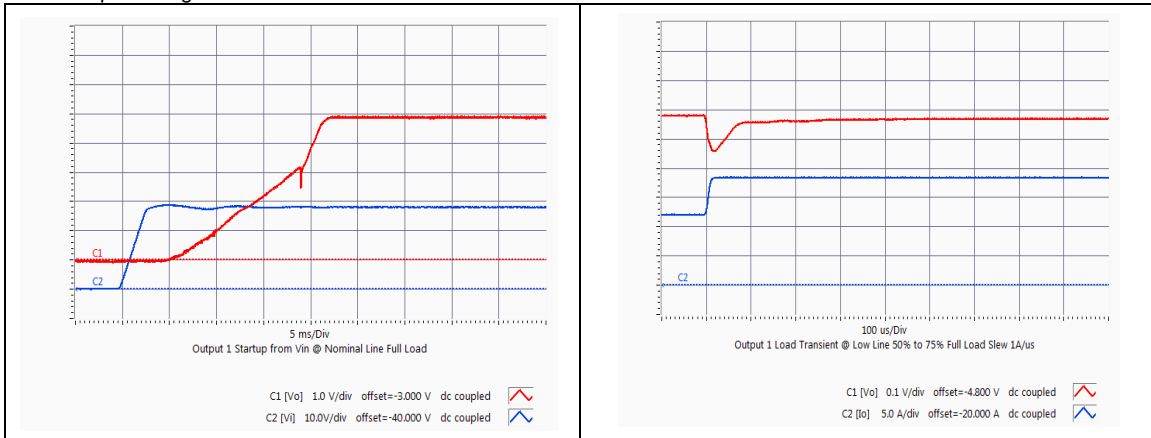

HQA2W120W050V Typical startup characteristic from input voltage application at full load. Red trace - output voltage, Blue trace - input voltage

HQA2W120W050V Typical output voltage response to load step from 50% to 75% of full load with output current slew rate of 1A/uS and $C_{ext} = 22\mu F$

Electrical Characteristics (continued): HQA2W120W050V: 5V, 24A Output

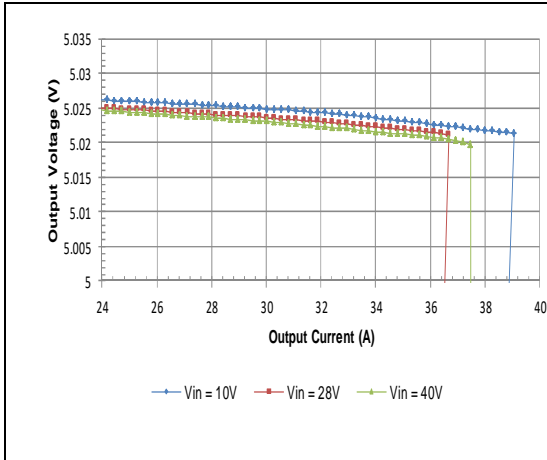

HQA2W120W050V Typical Output Current Limit Characteristics vs. Input Voltage at Ta=25 degrees

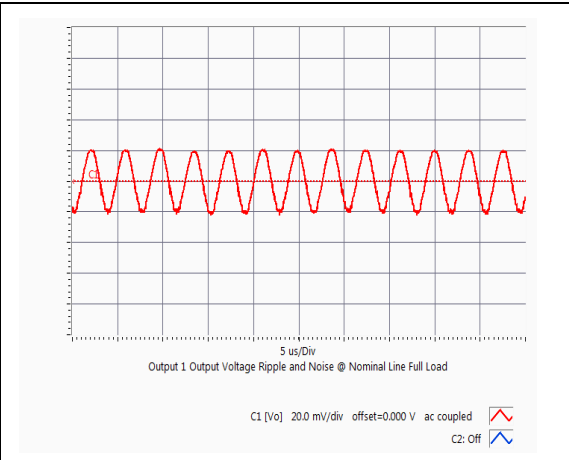

HQA2W120W050V Typical Output Ripple at nominal Input voltage and full load at Ta=25 degrees

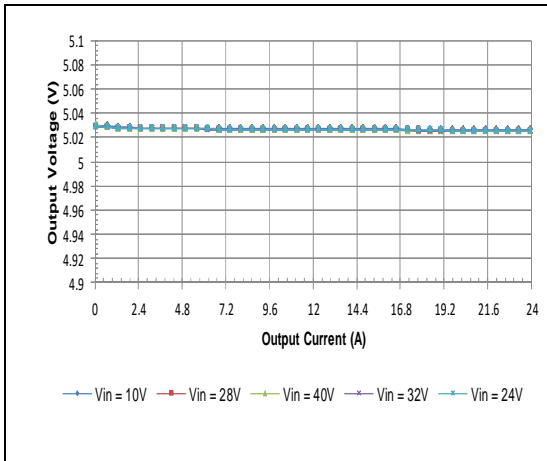

HQA2W120W050V Typical Load Regulation Characteristics at Ta=25 degrees

% Change of Vout	Trim Down Resistor	% Change of Vout	Trim Up Resistor
-5%	162K	+5%	19.8K
-10%	73.8K	+10%	7.8K

e.g. trim up 5%

$$R_{up} := \left(\frac{0.6 \cdot 10}{5.25 - 5} - 4.22 \right) \cdot 1000$$

HQA2W120W050V Calculated resistor values for output voltage adjustment

Intentionally blank

Thermal Performance: HQA2W120W050V: 5V, 24A Output

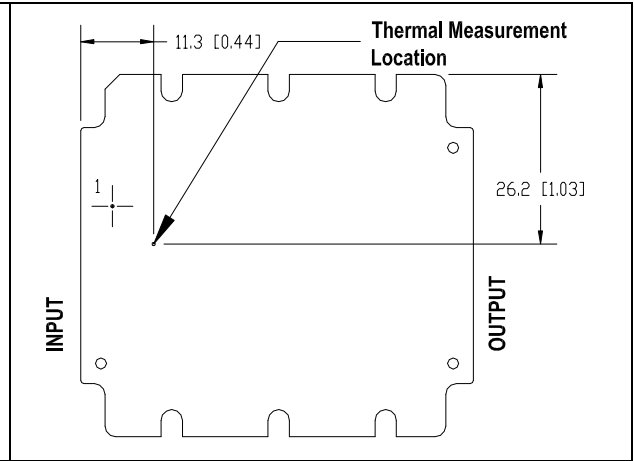
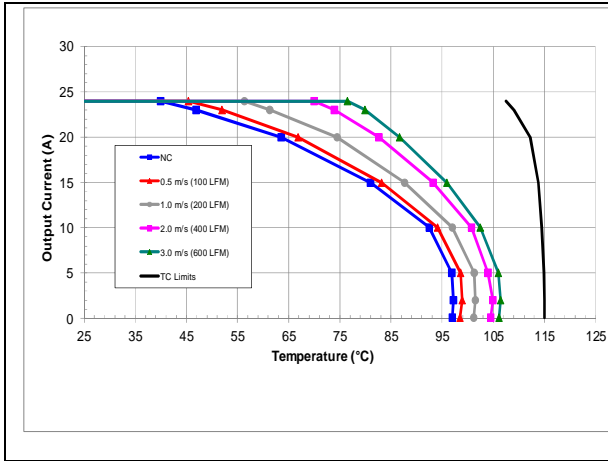

HQA2W120W050V maximum output current vs. ambient temperature at 28V input for airflow rates natural convection (60lfm) to 600lfm with airflow from pin 3 to pin 1

HQA2W120W050V thermal measurement location – top view

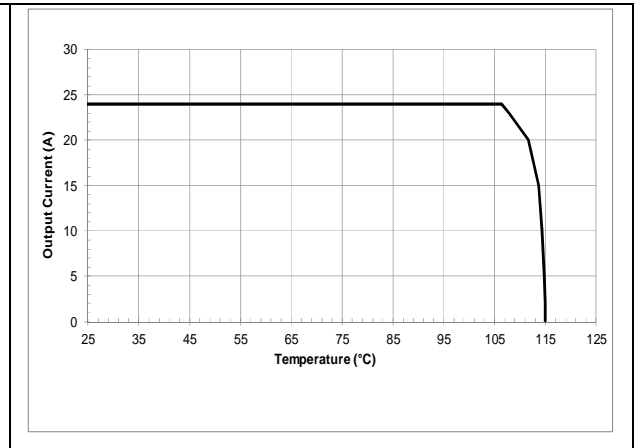
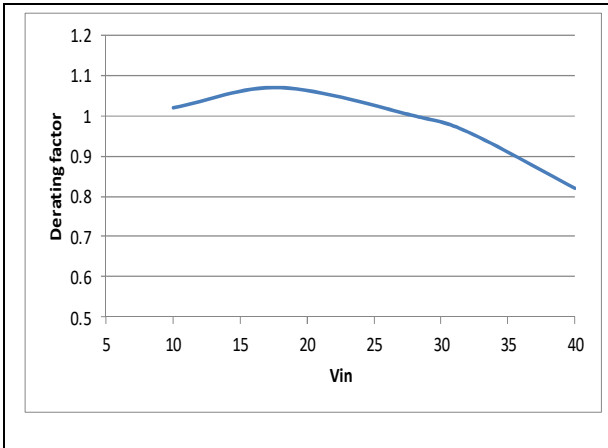

HQA2W120W050V typical temperature derating versus input voltage output with 2m/s (400 lfm) airflow from pin 3 to pin 1

HQA2W120W050V maximum output current vs. baseplate temperature at nominal line

The thermal curves provided are based upon measurements made in TDK-Lambda's experimental test setup that is described in the Thermal Management section. Due to the large number of variables in system design, TDK-Lambda recommends that the user verify the module's thermal performance in the end application. The critical component should be thermo coupled and monitored, and should not exceed the temperature limit specified in the derating curve above. It is critical that the thermocouple be mounted in a manner that gives direct thermal contact or significant measurement errors may result. TDK-Lambda can provide modules with a thermocouple pre-mounted to the critical component for system verification tests.

Thermal Management:

An important part of the overall system design process is thermal management; thermal design must be considered at all levels to ensure good reliability and lifetime of the final system. Superior thermal design and the ability to operate in severe application environments are key elements of a robust, reliable power module.

The mechanical design provides a low impedance thermal path from hot components to the base plate, which reduces areas of heat concentration and resulting hot spots.

Test Setup: The thermal performance of the power module was evaluated both in cold plate, conduction cooling environments and also in wind tunnel tests using the setup shown in the wind tunnel figure. The thermal test setups are intended to replicate some of the typical thermal environments that could be encountered in modern electronic systems.

The power module, as shown in the figure, is mounted on a printed circuit board (PCB) and is vertically oriented within the wind tunnel. The cross section of the airflow passage is rectangular. The spacing between the top of the module and a parallel facing PCB is kept at a constant (0.5 in). The power module's orientation with respect to the airflow direction can have an impact on the module's thermal performance.

Thermal Derating: For proper application of the power module in a given thermal environment, output current derating curves are provided as a design. The module temperature should be measured in the final system configuration to ensure proper thermal management of the power module.

For thermal performance verification, the module temperature should be measured at the base plate location indicated in the thermal measurement location figure on the thermal performance page for the power module of interest.

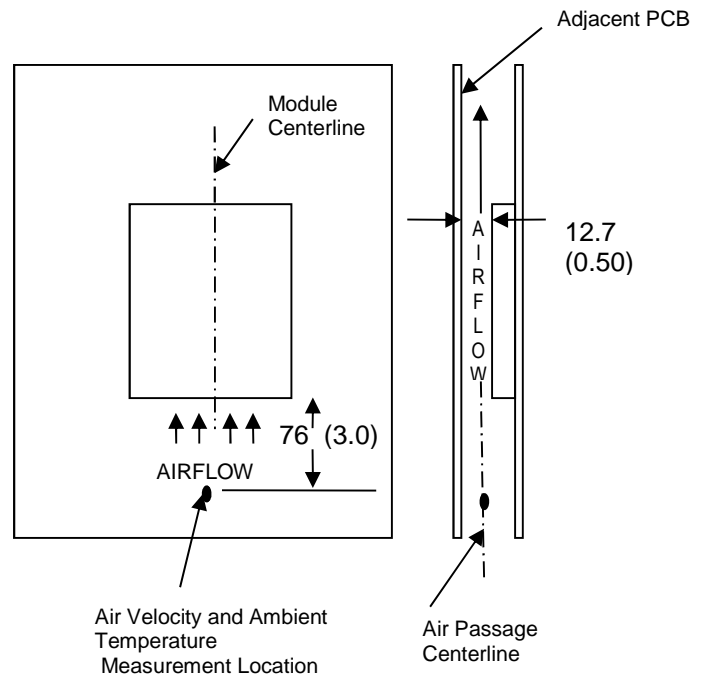

Wind Tunnel Test Setup Figure Dimensions are in millimeters and (inches).

In all conditions, the power module should be operated below the maximum operating temperature shown on the derating curve. For improved design margins and enhanced system reliability, the power module may be operated at temperatures below the maximum rated operating temperature.

In convection applications, heat transfer can be enhanced by increasing the airflow rate that the power module experiences. The maximum output current of the power module is a function of ambient temperature and airflow.

Operating Information:

Over-Current Protection: The power modules have current limit protection to protect the module during output overload and short circuit conditions. During overload conditions, the power modules may protect themselves by entering a hiccup current limit mode. The modules will operate normally once the output current returns to the specified operating range.

Output Over-Voltage Protection: The power modules have a maximum duty cycle limit to help reduce the risk of over voltage appearing at the output of the power module during fault conditions. If there is a fault in the voltage regulation loop, the protection circuitry will cause the power module to limit the output voltage. When the condition causing the over-voltage is corrected, the module will operate normally.

Thermal Protection: When the power modules exceed the maximum operating temperature, the modules may turn-off to safe-guard against thermal damage. The module will auto restart as the unit is cooled below the over temperature threshold.

Remote On/Off: - The power modules have an internal remote on/off circuit. The user must supply an open-collector or compatible switch between the Vin(-) pin and the on/off pin. The maximum voltage generated by the power module at the on/off terminal is 15V. The maximum allowable leakage current of the switch is 50uA. The switch must be capable of maintaining a low signal Von/off < 1.2V while sinking 1mA.

The standard on/off logic is negative logic. The power module will be off if terminal 2 is left open and will be on if terminal 2 is connected to terminal 3. If the on/off feature is not being used, terminal 2 should be shorted to terminal 3.

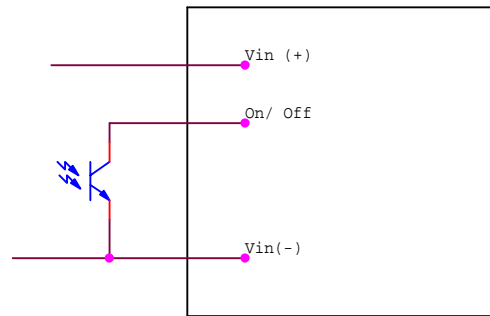

On/Off Circuit for negative logic

Output Voltage Adjustment: The output voltage of the power module may be adjusted by using an external resistor connected between the Vout trim terminal (pin 6) and either the Sense (+) or Sense (-) terminal or the Vout(+) and Vout(-) terminals if the sense feature is not populated. If the output voltage adjustment feature is not used, pin 6 should be left open. Care should be taken to avoid injecting noise into the power module's trim pin.

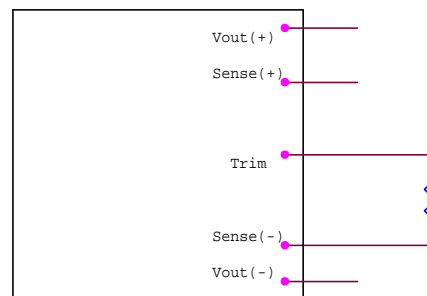

Circuit to increase output voltage

With a resistor between the trim and Sense (+) or Vout(+) terminals, the output voltage is adjusted down. To adjust the output voltage down a percentage of Vout (%Vo) from Vo,nom, the trim resistor should be chosen according to the following equation:

$$R_{\text{down}} := \left[\left[\frac{R_a \cdot (V_{\text{otrimdown}} - 0.6)}{V_{\text{onom}} - V_{\text{otrimdown}}} \right] - R_b \right] \cdot 1000$$

The current limit set point does not increase as the module is trimmed down, so the available output power is reduced.

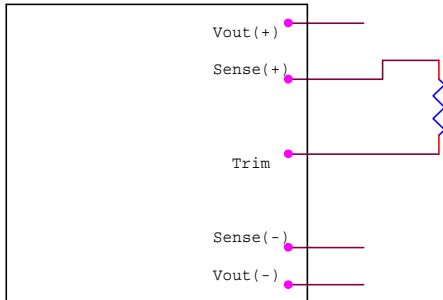

Circuit to decrease output voltage

With a resistor between the trim and sense (-) or Vout (-) terminals, the output voltage is adjusted up. To adjust the output voltage up a percentage of Vout (%Vo) from Vo,nom the trim resistor should be chosen according to the following equation:

For all outputs:

$$R_{up} := \left[\frac{0.6 \cdot R_a}{(V_{otrimup} - V_{onom})} - R_b \right] \cdot 1000$$

The maximum power available from the power module is fixed. As the output voltage is trimmed up, the maximum output current must be decreased to maintain the maximum rated power of the module. As the output voltage is trimmed, the output over-voltage set point is not adjusted. Trimming the output voltage too high may cause the output over voltage protection circuit to be triggered.

To avoid possible damage, care should be taken not to connect the sense (+) or Vout (+) terminals directly to the module's trim pin.

Remote Sense: Some HQA power modules feature remote sense to compensate for the effect of output distribution drops. The output voltage sense range defines the maximum voltage allowed between the output power terminals and output sense terminals, and it is found on the electrical data page for the power module of interest. If the remote sense feature is not being used, the Sense(+) terminal should be connected to the Vo(+) terminal and the Sense (-) terminal should be connected to the Vo(-) terminal.

The output voltage at the Vo(+) and Vo(-) terminals can be increased by either the remote sense or the output voltage adjustment feature. The maximum voltage increase allowed is the larger of the remote sense range or the output voltage adjustment range; it is not the sum of both.

As the output voltage increases due to the use of the remote sense, the maximum output current must be decreased for the power module to remain below its maximum power rating.

EMC Considerations: TDK-Lambda power modules are designed for use in a wide variety of systems and applications. For assistance with designing for EMC compliance, please contact technical support.

Input Impedance:

The source impedance of the power feeding the DC/DC converter module will interact with the DC/DC converter. To minimize the interaction, a minimum 100uF input capacitor is recommended.

Input/Output Ripple and Noise Measurements:

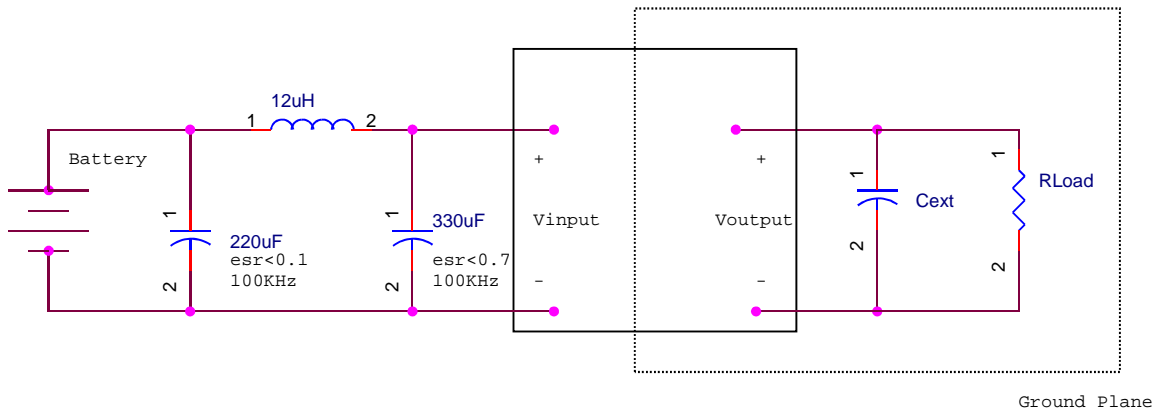

The input reflected ripple is measured with a current probe and oscilloscope. The ripple current is the current through the 12uH inductor.

The output ripple measurement is made approximately 9 cm (3.5 in.) from the power module using an oscilloscope and BNC socket. The capacitor Cext is located about 5 cm (2 in.) from the power module; its value varies from code to code and is found on the electrical data page for the power module of interest under the ripple & noise voltage specification in the Notes & Conditions column.

Reliability:

The power modules are designed using TDK-Lambda's stringent design guidelines for component derating, product qualification, and design reviews. Early failures are screened out by both burn-in and an automated final test.

Improper handling or cleaning processes can adversely affect the appearance, testability, and reliability of the power modules. Contact technical support for guidance regarding proper handling, cleaning, and soldering of TDK-Lambda's power modules.

Test Options:

OPERATION	S-Grade	M-Grade
Functional Test	Room and Hot Test	Cold, Room, and Hot Test
Burn In	Yes	Extended, 96 hour
Temperature Cycling	N/A	10 Cycles
Hi-Pot	2250Vdc	2250Vdc
Visual Inspection	Yes	Yes

Safety Considerations:

As of the publishing date, certain safety agency approvals may have been received on the HQA series and others may still be pending. Check with TDK-Lambda for the latest status of safety approval on the HQA product line.

For safety agency approval of the system in which the DC-DC power module is installed, the power module must be installed in compliance with the creepage and clearance requirements of the safety agency. The isolation is operational insulation. Care must be taken to maintain minimum creepage and clearance distances when routing traces near the power module.

As part of the production process, the power modules are hi-pot tested from primary and secondary at a test voltage of 2250Vdc.

To preserve maximum flexibility, the power modules are not internally fused. An external input line normal blow fuse with a maximum value of 30A is required by safety agencies. A lower value fuse can be selected based upon the maximum dc input current and maximum inrush energy of the power module.

The power module meets all of the requirements for SELV, provided that the input meets SELV requirements.

Warranty:

TDK-Lambda's comprehensive line of power solutions includes efficient, high-density DC-DC converters. TDK-Lambda offers a three-year limited warranty. Complete warranty information is listed on our web site or is available upon request from TDK-Lambda.

Information furnished by TDK-Lambda is believed to be accurate and reliable. However, TDK-Lambda assumes no responsibility for its use, nor for any infringement of patents or other rights of third parties, which may result from its use. No license is granted by implication or otherwise under any patent or patent rights of TDK-Lambda. TDK-Lambda components are not designed to be used in critical applications, such as nuclear control systems or life support systems, wherein failure or malfunction could result in injury or death. All sales are subject to TDK-Lambda's Terms and Conditions of Sale, which are available upon request. Specifications are subject to change without notice.



TDK-Lambda France SAS

Tel: +33 1 60 12 71 65
france@fr.tdk-lambda.com
www.emea.lambda.tdk.com/fr



Italy Sales Office

Tel: +39 02 61 29 38 63
info.italia@it.tdk-lambda.com
www.emea.lambda.tdk.com/it



Netherlands

info@nl.tdk-lambda.com
www.emea.lambda.tdk.com/nl



TDK-Lambda Germany GmbH

Tel: +49 7841 666 0
info.germany@de.tdk-lambda.com
www.emea.lambda.tdk.com/de



Austria Sales Office

Tel: +43 2256 655 84
info@at.tdk-lambda.com
www.emea.lambda.tdk.com/at



Switzerland Sales Office

Tel: +41 44 850 53 53
info@ch.tdk-lambda.com
www.emea.lambda.tdk.com/ch



Nordic Sales Office

Tel: +45 8853 8086
info@dk.tdk-lambda.com
www.emea.lambda.tdk.com/dk

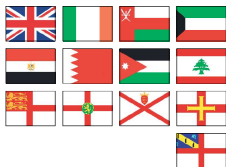

TDK-Lambda UK Ltd.

Tel: +44 (0) 12 71 85 66 66
powersolutions@uk.tdk-lambda.com
www.emea.lambda.tdk.com/uk



TDK-Lambda Ltd.

Tel: +9 723 902 4333
info@tdk-lambda.co.il
www.emea.lambda.tdk.com/il



C.I.S.

Commercial Support:

Tel: +7 (495) 665 2627

Technical Support:

Tel: +7 (812) 658 0463
info@tdk-lambda.ru
www.emea.lambda.tdk.com/ru



TDK-Lambda Americas

Tel: +1 800-LAMBDA-4 or 1-800-526-2324
powersolutions@us.tdk-lambda.com
www.us.lambda.tdk.com



TDK Electronics do Brasil Ltda

Tel: +55 11 3289-9599
sales.br@tdk-electronics.tdk.com
www.tdk-electronics.tdk.com/en



TDK-Lambda Corporation

Tel: +81-3-6778-1113
www.jp.lambda.tdk.com



Wuxi TDK-Lambda Electronics Co. Ltd.

Tel: +86 21 6485-0777
powersolutions@cn.tdk-lambda.com
www.lambda.tdk.com.cn



TDK-Lambda Singapore Pte Ltd.

Tel: +65 6251 7211
tfs.mkt@sg.tdk-lambda.com
www.sg.lambda.tdk.com



TDK India Private Limited, Power Supply Division

Tel: +91 80 4039-0660
mathew.philip@in.tdk-lambda.com
www.lambda.tdk.com

