

NO. OF CKTS.	DIM. A	DIM. B
1	(2.44 ± .15) .096 ± .006	—
2	(4.98 ± .15) .196 ± .006	(2.54 ± .10) .100 ± .004
3	(7.52 ± .15) .296 ± .006	(5.08 ± .10) .200 ± .004
4	(10.06 ± .15) .396 ± .006	(7.62 ± .10) .300 ± .004
5	(12.60 ± .18) .496 ± .007	(10.16 ± .13) .400 ± .005
6	(15.14 ± .18) .596 ± .007	(12.70 ± .13) .500 ± .005
7	(17.68 ± .20) .696 ± .008	(15.24 ± .15) .600 ± .006
8	(20.22 ± .20) .796 ± .008	(17.78 ± .15) .700 ± .006
9	(22.76 ± .20) .896 ± .008	(20.32 ± .15) .800 ± .006
10	(25.30 ± .25) .996 ± .010	(22.86 ± .20) .900 ± .008
11	(27.84 ± .25) 1.096 ± .010	(25.40 ± .20) 1.000 ± .008
12	(30.38 ± .25) 1.196 ± .010	(27.94 ± .20) 1.100 ± .008
13	(32.92 ± .25) 1.296 ± .010	(30.48 ± .20) 1.200 ± .008
14	(35.46 ± .25) 1.396 ± .010	(33.02 ± .20) 1.300 ± .008
15	(38.00 ± .28) 1.496 ± .011	(35.56 ± .23) 1.400 ± .009
16	(40.54 ± .28) 1.596 ± .011	(38.10 ± .23) 1.500 ± .009
17	(43.08 ± .28) 1.696 ± .011	(40.64 ± .23) 1.600 ± .009
18	(45.62 ± .28) 1.796 ± .011	(43.18 ± .23) 1.700 ± .009
19	(48.16 ± .28) 1.896 ± .011	(45.72 ± .23) 1.800 ± .009
20	(50.70 ± .30) 1.996 ± .012	(48.26 ± .25) 1.900 ± .010

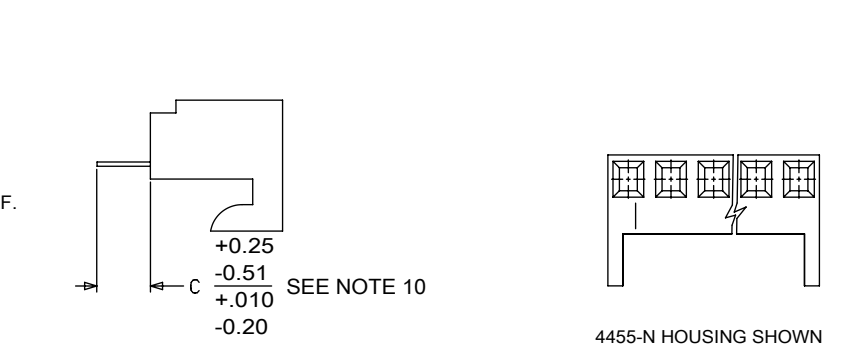

- NOTES:
- MATERIAL: NYLON, UL 94V-0, COLOR: WHITE
  - FINISH:
    - (208) - SELECT GOLD: (0.00038)/.000015 MIN., SELECT TIN: (0.00254)/.000100 MIN. OVERALL NICKEL UNDERPLATE: (0.00127)/.000050 MIN.
    - (228) - SELECT GOLD: (0.00076)/.000030 MIN., SELECT TIN: (0.00254)/.000100 MIN. OVERALL NICKEL UNDERPLATE: (0.00127)/.000050 MIN.
    - (231) - SELECT GOLD: (0.00127)/.000050 MIN., SELECT TIN: (0.00254)/.000100 MIN. OVERALL NICKEL UNDERPLATE: (0.00127)/.000050 MIN.
    - (565) - SELECT GOLD: (0.00051)/.000020 MIN., OVERALL NICKEL: (0.00076)/.000030 MIN. OVERALL GOLD FLASH: (0.00005)/.000002 MIN.
    - (P909) - OVERALL TIN: (0.00254)/.000100 MIN.
  - PARTS CONFORM TO PRODUCT SPECIFICATION PS-10-07.
  - PACKAGING: SEE CHARTS.
  - PARTS MUST CONFORM TO SOLDERABILITY SPEC 152.
  - PARTS ARE STACKABLE END TO END ON (2.54)/.100 CENTERS.
  - TYPICAL PCB THICKNESS: (1.57)/.062
  - PART CONFORMS TO CLASS B REQUIREMENTS OF COSMETIC SPECIFICATION PS-45499-002 EXCEPT PROTRUSIONS. PARTS MAY HAVE MORE THAN 2 GATE MARKS.
  - WHEN MATING ASSEMBLIES THAT USE 4455-BN HOUSINGS TO BREAKAWAY FRICTION LOCK OR POLARIZING HEADERS, THE END BACKWALLS MUST BE REMOVED.
  - DIMENSION C MEASURED WITH TERMINAL PUSHED IN AGAINST THE STOP.

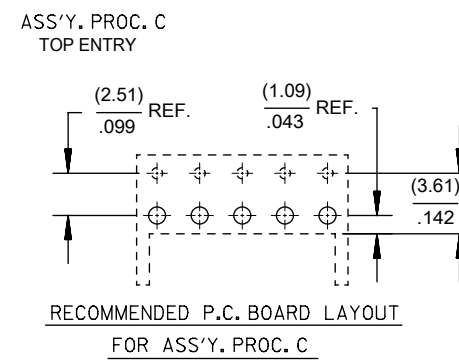
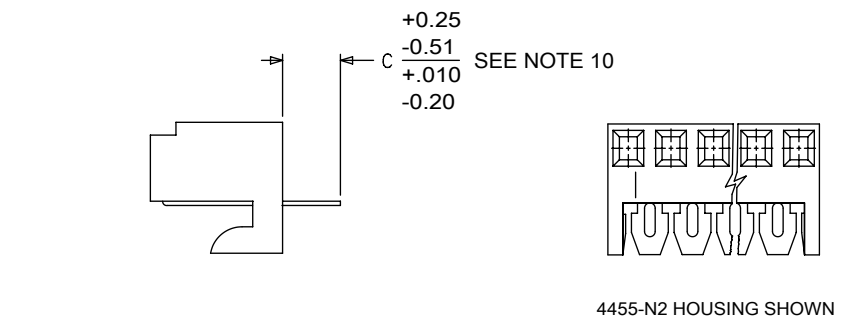
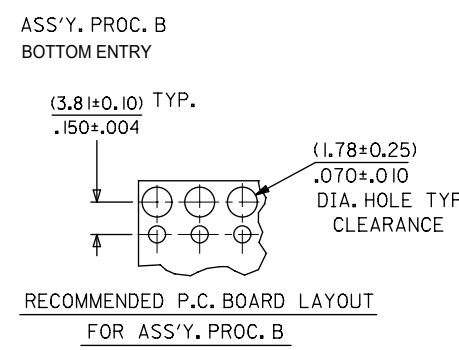
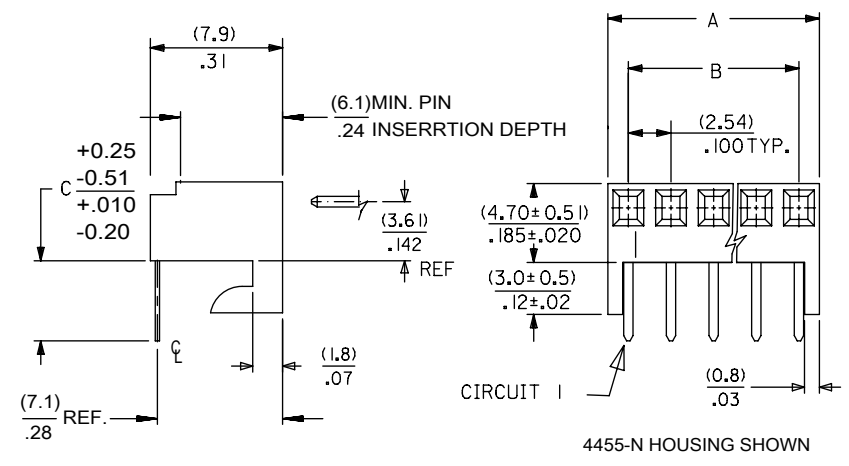
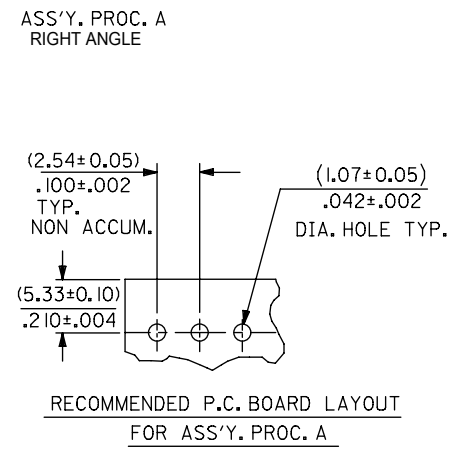
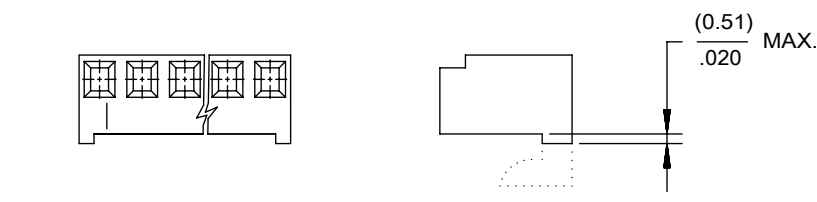
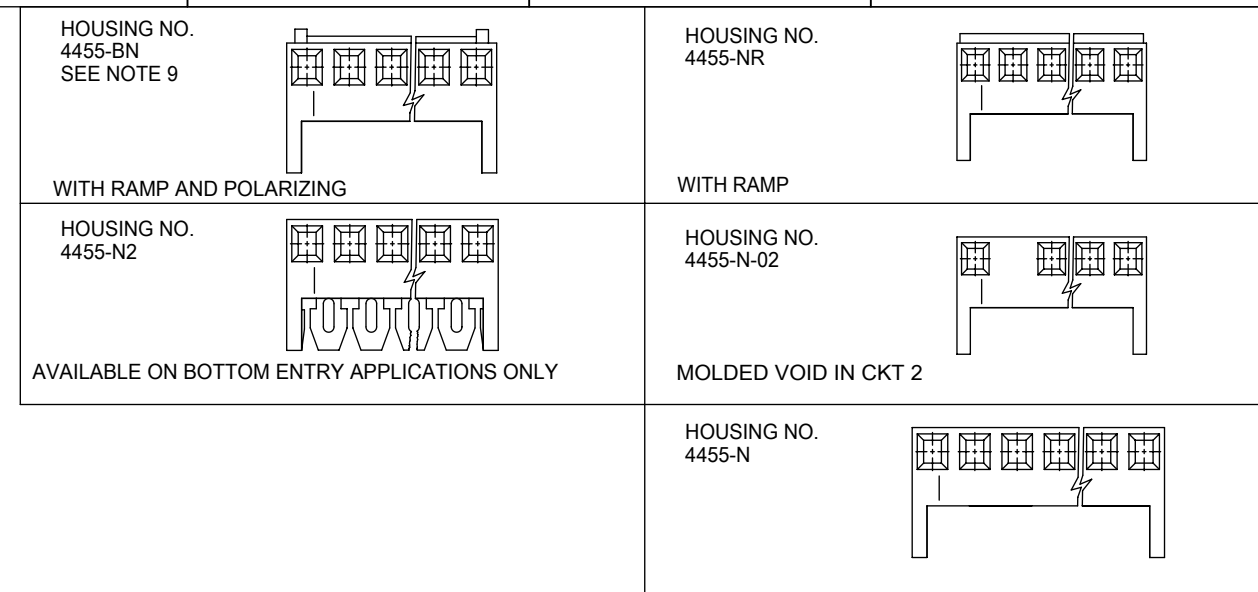

HOOKS CUT OPTION AVAILABLE ON TOP ENTRY, SEE CHART

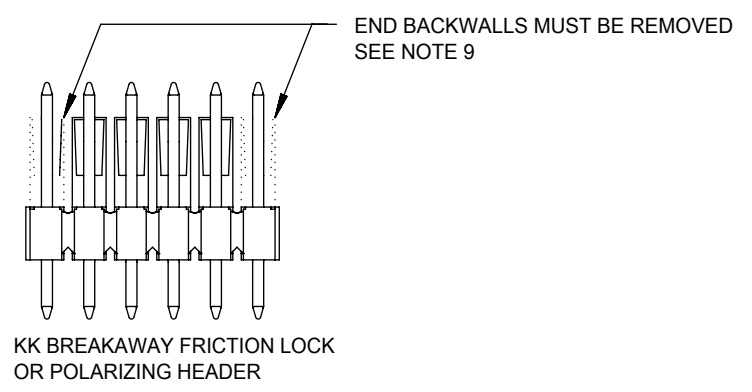

DOCUMENT STATUS	P1	RELEASE DATE	2018/08/13	11:53:00
-----------------	----	--------------	------------	----------

SYMBOLS		THIS DRAWING CONTAINS INFORMATION THAT IS PROPRIETARY TO MOLEX ELECTRONIC TECHNOLOGIES, LLC AND SHOULD NOT BE USED WITHOUT WRITTEN PERMISSION		CURRENT REV DESC: ADDED NEW P/N'S	
▽ = 0	DIMENSION UNITS	SCALE			
▽ = 0	MM/IN	1:1			
▽ = 0	GENERAL TOLERANCES (UNLESS SPECIFIED)				
▽ = 0		MM	INCH		
▽ = 0	4 PLACES	±	±		
▽ = 0	3 PLACES	±	± 0.01		
▽ = 0	2 PLACES	± 0.25	± 0.015		
▽ = 0	1 PLACE	± 0.36	±		
▽ = 0	0 PLACES	±	±		
▽ = 0	ANGULAR TOL		± 0.5°		
▽ = 0	DRAFT WHERE APPLICABLE MUST REMAIN WITHIN DIMENSIONS		THIRD ANGLE PROJECTION	DRAWING	SERIES
▽ = 0			⊕	B-SIZE	4455
			EC NO: 602687		
			DRWN: SS06	2018/06/18	
			CHK'D: ISHWARG	2018/08/13	
			APPR: ISHWARG	2018/08/13	
			INITIAL REVISION:		
			DRWN: SAMIEC	1984/05/10	
			APPR: LENZ	1984/05/10	
DOCUMENT NUMBER		DOC TYPE	DOC PART	REVISION	
SDA-4455		PSD	001	D16	
MATERIAL NUMBER		CUSTOMER		SHEET NUMBER	
SEE CHART		GENERAL MARKET		1 OF 1	

2-*	D15
1	D16
SHT.	REV.

**molex**

KK 100 PCB ASSY  
4455 SERIES DWG

PRODUCT CUSTOMER DRAWING



# KK 100 PCB ASSY 2-20 CKT

## 4455 SERIES

STANDARD PRODUCT

**A-4455- \* \* N \* \* - \* - \***

ASSY PROCEDURE  
 A=RIGHT ANGLE  
 B=BOTTOM ENTRY  
 C=TOP ENTRY

HOUSING OPTION  
 B=4455-BN  
 G=4455-BN (HOOKS CUT OFF)  
 H=4455-N2 (BOTTOM ENTRY ONLY)  
 P=4455-NR (HOOKS CUT OFF)  
 R=4455-NR  
 V=4455-N-02  
 W=4455-N-02 (HOOKS CUT OFF)  
 Y=4455-N (HOOKS CUT OFF)  
 Z=4455-N

NO OF CIRCUITS

TERMINAL TYPE

Code	Number	Material	Form
A	4316-4	Brass	Standard
B	6516-4	Phos Bronze	Standard
C	6516-5C	Phos Bronze	Cat Ear / V
D	4316-3B	Brass	Std / V
F	6516-6C	Phos Bronze	Cat Ear / V
G	4316-3	Brass	Standard
J	6516-3B	Phos Bronze	Std / V
L	6516-3C	Phos Bronze	Cat Ear / V
M	6516-4A	Phos Bronze	Cat Ear
T	4316-4A	Brass	Cat Ear

VOID LOCATION  
 NUMBER = CIRCUIT  
 VOIDED  
 MULTIPLE VOIDS START  
 WITH 51  
 BLANK = NONE

PACKAGING  
 A = TRAY  
 B = TAPE AND REEL

PLATING  
 (SEE SHEET 1)

Assy Proc:	RIGHT ANGLE
Hooks Cut:	NO
Housing No:	4455-N
Terminal No:	4316-4(P909)
Dim C:	3.35 / .132
Plating:	P909
Packaging:	PK-44646-001
Voids:	NONE

Assy Proc:	RIGHT ANGLE
Hooks Cut:	NO
Housing No:	4455-N
Terminal No:	4316-4(565)
Dim C:	3.35 / .132
Plating:	565
Packaging:	PK-44646-001
Voids:	NONE

Ckts	Material No	Engineer Number
2	22-15-2026	A-4455-AZ02A(P909)
3	22-15-2036	A-4455-AZ03A(P909)
4	22-15-2046	A-4455-AZ04A(P909)
5	22-15-2056	A-4455-AZ05A(P909)
6	22-15-2066	A-4455-AZ06A(P909)
7	22-15-2076	A-4455-AZ07A(P909)
8	22-15-2086	A-4455-AZ08A(P909)
9	22-15-2096	A-4455-AZ09A(P909)
10	22-15-2106	A-4455-AZ10A(P909)
11	22-15-2116	A-4455-AZ11A(P909)
12	22-15-2126	A-4455-AZ12A(P909)
13	22-15-2136	A-4455-AZ13A(P909)
14	22-15-2146	A-4455-AZ14A(P909)
15	22-15-2156	A-4455-AZ15A(P909)
16	22-15-2166	A-4455-AZ16A(P909)
17	22-15-2176	A-4455-AZ17A(P909)
18	22-15-2186	A-4455-AZ18A(P909)
19	22-15-2196	A-4455-AZ19A(P909)
20	22-15-2206	A-4455-AZ20A(P909)

Material No	Engineer Number
22-16-2021	A-4455-AZ02A(565)
22-16-2031	A-4455-AZ03A(565)
22-16-2041	A-4455-AZ04A(565)
22-16-2051	A-4455-AZ05A(565)
22-16-2061	A-4455-AZ06A(565)
22-16-2071	A-4455-AZ07A(565)
22-16-2081	A-4455-AZ08A(565)
22-16-2091	A-4455-AZ09A(565)
22-16-2101	A-4455-AZ10A(565)
22-16-2111	A-4455-AZ11A(565)
22-16-2121	A-4455-AZ12A(565)
22-16-2131	A-4455-AZ13A(565)
22-16-2141	A-4455-AZ14A(565)
22-16-2151	A-4455-AZ15A(565)
22-16-2161	A-4455-AZ16A(565)
22-16-2171	A-4455-AZ17A(565)
22-16-2181	A-4455-AZ18A(565)
22-16-2191	A-4455-AZ19A(565)
22-16-2201	A-4455-AZ20A(565)

REV:	<b>ECM INFORMATION:</b>	<u>TITLE:</u>	<u>SHEET No.</u>
<b>D15</b>	ECM No.: <b>602687</b>	<b>KK 100 PCB ASSY 4455 SERIES DWG</b>	<b>- 2 -</b>
	DATE: <b>22/06/2018</b>		
<u>DOCUMENT NUMBER:</u>	<u>DOC TYPE:</u>	<u>DOC PART:</u>	<u>CREATED / REVISED BY:</u>
<b>SDA-4455</b>	<b>PSD</b>	<b>002</b>	<b>SS06</b>
<u>CHECKED BY:</u>		<u>APPROVED BY:</u>	
<b>SS06</b>		<b>ISHWARG</b>	



# KK 100 PCB ASSY 2-20 CKT

## 4455 SERIES

STANDARD PRODUCT

Ckts	Assy Proc: RIGHT ANGLE		Assy Proc: BOTTOM ENTRY		Assy Proc: BOTTOM ENTRY		Assy Proc: BOTTOM ENTRY	
	Hooks Cut:	NO	Hooks Cut:	NO	Hooks Cut:	NO	Hooks Cut:	NO
	Housing No:	4455-N	Housing No:	4455-N2	Housing No:	4455-N2	Housing No:	4455-N2
	Terminal No:	4316-4(208)	Terminal No:	4316-3B(P909)	Terminal No:	4316-3B(565)	Terminal No:	4316-3B(208)
	Dim C:	3.35 / .132	Dim C:	3.35 / .132	Dim C:	3.35 / .132	Dim C:	3.35 / .132
	Plating:	208	Plating:	P909	Plating:	565	Plating:	208
	Packaging:	PK-44646-001	Packaging:	PK-44646-001	Packaging:	PK-44646-001	Packaging:	PK-44646-001
	Voids:	NONE	Voids:	NONE	Voids:	NONE	Voids:	NONE
	Material No	Engineer Number	Material No	Engineer Number	Material No	Engineer Number	Material No	Engineer Number
2	22-16-2020	A-4455-AZ02A(208)	22-14-2024	A-4455-BH02D(P909)	22-17-2022	A-4455-BH02D(565)	22-17-3022	A-4455-BH02D(208)
3	22-16-2030	A-4455-AZ 03 A(208)	22-14-2034	A-4455-BH 03 D(P909)	22-17-2032	A-4455-BH 03 D(565)	22-17-3032	A-4455-BH 03 D(208)
4	22-16-2040	A-4455-AZ 04 A(208)	22-14-2044	A-4455-BH 04 D(P909)	22-17-2042	A-4455-BH 04 D(565)	22-17-3042	A-4455-BH 04 D(208)
5	22-16-2050	A-4455-AZ 05 A(208)	22-14-2054	A-4455-BH 05 D(P909)	22-17-2052	A-4455-BH 05 D(565)	22-17-3052	A-4455-BH 05 D(208)
6	22-16-2060	A-4455-AZ 06 A(208)	22-14-2064	A-4455-BH 06 D(P909)	22-17-2062	A-4455-BH 06 D(565)	22-17-3062	A-4455-BH 06 D(208)
7	22-16-2070	A-4455-AZ 07 A(208)	22-14-2074	A-4455-BH 07 D(P909)	22-17-2072	A-4455-BH 07 D(565)	22-17-3072	A-4455-BH 07 D(208)
8	22-16-2080	A-4455-AZ 08 A(208)	22-14-2084	A-4455-BH 08 D(P909)	22-17-2082	A-4455-BH 08 D(565)	22-17-3082	A-4455-BH 08 D(208)
9	22-16-2090	A-4455-AZ 09 A(208)	22-14-2094	A-4455-BH 09 D(P909)	22-17-2092	A-4455-BH 09 D(565)	22-17-3092	A-4455-BH 09 D(208)
10	22-16-2100	A-4455-AZ 10 A(208)	22-14-2104	A-4455-BH 10 D(P909)	22-17-2102	A-4455-BH 10 D(565)	22-17-3102	A-4455-BH 10 D(208)
11	22-16-2110	A-4455-AZ 11 A(208)	22-14-2114	A-4455-BH 11 D(P909)	22-17-2112	A-4455-BH 11 D(565)	22-17-3112	A-4455-BH 11 D(208)
12	22-16-2120	A-4455-AZ 12 A(208)	22-14-2124	A-4455-BH 12 D(P909)	22-17-2122	A-4455-BH 12 D(565)	22-17-3122	A-4455-BH 12 D(208)
13	22-16-2130	A-4455-AZ 13 A(208)	22-14-2134	A-4455-BH 13 D(P909)	22-17-2132	A-4455-BH 13 D(565)	22-17-3132	A-4455-BH 13 D(208)
14	22-16-2140	A-4455-AZ 14 A(208)	22-14-2144	A-4455-BH 14 D(P909)	22-17-2142	A-4455-BH 14 D(565)	22-17-3142	A-4455-BH 14 D(208)
15	22-16-2150	A-4455-AZ 15 A(208)	22-14-2154	A-4455-BH 15 D(P909)	22-17-2152	A-4455-BH 15 D(565)	22-17-3152	A-4455-BH 15 D(208)
16	22-16-2160	A-4455-AZ 16 A(208)	22-14-2164	A-4455-BH 16 D(P909)	22-17-2162	A-4455-BH 16 D(565)	22-17-3162	A-4455-BH 16 D(208)
17	22-16-2170	A-4455-AZ 17 A(208)	22-14-2174	A-4455-BH 17 D(P909)	22-17-2172	A-4455-BH 17 D(565)	22-17-3172	A-4455-BH 17 D(208)
18	22-16-2180	A-4455-AZ 18 A(208)	22-14-2184	A-4455-BH 18 D(P909)	22-17-2182	A-4455-BH 18 D(565)	22-17-3182	A-4455-BH 18 D(208)
19	22-16-2190	A-4455-AZ 19 A(208)	22-14-2194	A-4455-BH 19 D(P909)	22-17-2192	A-4455-BH 19 D(565)	22-17-3192	A-4455-BH 19 D(208)
20	22-16-2200	A-4455-AZ 20 A(208)	22-14-2204	A-4455-BH 20 D(P909)	22-17-2202	A-4455-BH 20 D(565)	22-17-3202	A-4455-BH 20 D(208)

REV:	<b>ECM INFORMATION:</b>	<u>TITLE:</u>	<h2 style="margin: 0;">KK 100 PCB ASSY</h2> <h2 style="margin: 0;">4455 SERIES DWG</h2>	<u>SHEET No.</u>	
<b>D15</b>	ECM No.: <b>602687</b>			<b>- 3 -</b>	
	DATE: <b>22/06/2018</b>				
<u>DOCUMENT NUMBER:</u>	<u>DOC TYPE:</u>	<u>DOC PART:</u>	<u>CREATED / REVISED BY:</u>	<u>CHECKED BY:</u>	<u>APPROVED BY:</u>
<b>SDA-4455</b>	<b>PSD</b>	<b>002</b>	<b>SS06</b>	<b>SS06</b>	<b>ISHWARG</b>



# KK 100 PCB ASSY 2-20 CKT

## 4455 SERIES

Assy Proc:	TOP ENTRY
Hooks Cut:	NO
Housing No:	4455-N
Terminal No:	4316-4(P909)
Dim C:	3.35 / .132
Plating:	P909
Packaging:	PK-44646-001
Voids:	NONE

Assy Proc:	TOP ENTRY
Hooks Cut:	NO
Housing No:	4455-N
Terminal No:	4316-4(565)
Dim C:	3.35 / .132
Plating:	565
Packaging:	PK-44646-001
Voids:	NONE

Assy Proc:	TOP ENTRY
Hooks Cut:	NO
Housing No:	4455-N
Terminal No:	4316-4(208)
Dim C:	3.35 / .132
Plating:	208
Packaging:	PK-44646-001
Voids:	NONE

Assy Proc:	TOP ENTRY
Hooks Cut:	NO
Housing No:	4455-N
Terminal No:	6516-4(P909)
Dim C:	3.35 / .132
Plating:	P909
Packaging:	PK-44646-001
Voids:	NONE

Ckts	Material No	Engineer Number	Material No	Engineer Number	Material No	Engineer Number	Material No	Engineer Number
2	22-02-2025	A-4455-CZ02A(P909)	22-18-2023	A-4455-CZ02A(565)	22-18-2021	A-4455-CZ02A(208)	22-15-4025	A-4455-AZ02B(P909)
3	22-02-2035	A-4455-CZ 03A(P909)	22-18-2033	A-4455-CZ 03 A(565)	22-18-2031	A-4455-CZ 03 A(208)	22-15-4035	A-4455-AZ 03B(P909)
4	22-02-2045	A-4455-CZ 04A(P909)	22-18-2043	A-4455-CZ 04 A(565)	22-18-2041	A-4455-CZ 04 A(208)	22-15-4045	A-4455-AZ 04B(P909)
5	22-02-2055	A-4455-CZ 05A(P909)	22-18-2053	A-4455-CZ 05 A(565)	22-18-2051	A-4455-CZ 05 A(208)	22-15-4055	A-4455-AZ 05B(P909)
6	22-02-2065	A-4455-CZ 06A(P909)	22-18-2063	A-4455-CZ 06 A(565)	22-18-2061	A-4455-CZ 06 A(208)	22-15-4065	A-4455-AZ 06B(P909)
7	22-02-2075	A-4455-CZ 07A(P909)	22-18-2073	A-4455-CZ 07 A(565)	22-18-2071	A-4455-CZ 07 A(208)	22-15-4075	A-4455-AZ 07B(P909)
8	22-02-2085	A-4455-CZ 08 A(P909)	22-18-2083	A-4455-CZ 08 A(565)	22-18-2081	A-4455-CZ 08 A(208)	22-15-4085	A-4455-AZ 08B(P909)
9	22-02-2095	A-4455-CZ 09 A(P909)	22-18-2093	A-4455-CZ 09 A(565)	22-18-2091	A-4455-CZ 09 A(208)	22-15-4095	A-4455-AZ 09B(P909)
10	22-02-2105	A-4455-CZ 10 A(P909)	22-18-2103	A-4455-CZ 10 A(565)	22-18-2101	A-4455-CZ 10 A(208)	22-15-4105	A-4455-AZ 10B(P909)
11	22-02-2115	A-4455-CZ 11 A(P909)	22-18-2113	A-4455-CZ 11 A(565)	22-18-2111	A-4455-CZ 11 A(208)	22-15-4115	A-4455-AZ 11B(P909)
12	22-02-2125	A-4455-CZ 12 A(P909)	22-18-2123	A-4455-CZ 12 A(565)	22-18-2121	A-4455-CZ 12 A(208)	22-15-4125	A-4455-AZ 12B(P909)
13	22-02-2135	A-4455-CZ 13 A(P909)	22-18-2133	A-4455-CZ 13 A(565)	22-18-2131	A-4455-CZ 13 A(208)	22-15-4135	A-4455-AZ 13B(P909)
14	22-02-2145	A-4455-CZ 14 A(P909)	22-18-2143	A-4455-CZ 14 A(565)	22-18-2141	A-4455-CZ 14 A(208)	22-15-4145	A-4455-AZ 14B(P909)
15	22-02-2155	A-4455-CZ 15 A(P909)	22-18-2153	A-4455-CZ 15 A(565)	22-18-2151	A-4455-CZ 15 A(208)	22-15-4155	A-4455-AZ 15B(P909)
16	22-02-2165	A-4455-CZ 16 A(P909)	22-18-2163	A-4455-CZ 16 A(565)	22-18-2161	A-4455-CZ 16 A(208)	22-15-4165	A-4455-AZ 16B(P909)
17	22-02-2175	A-4455-CZ 17 A(P909)	22-18-2173	A-4455-CZ 17 A(565)	22-18-2171	A-4455-CZ 17 A(208)	22-15-4175	A-4455-AZ 17B(P909)
18	22-02-2185	A-4455-CZ 18 A(P909)	22-18-2183	A-4455-CZ 18 A(565)	22-18-2181	A-4455-CZ 18 A(208)	22-15-4185	A-4455-AZ 18B(P909)
19	22-02-2195	A-4455-CZ 19 A(P909)	22-18-2193	A-4455-CZ 19 A(565)	22-18-2191	A-4455-CZ 19 A(208)	22-15-4195	A-4455-AZ 19B(P909)
20	22-02-2205	A-4455-CZ 20 A(P909)	22-18-2203	A-4455-CZ 20 A(565)	22-18-2201	A-4455-CZ 20 A(208)	22-15-4205	A-4455-AZ 20B(P909)

REV:	<b>ECM INFORMATION:</b>	TITLE:	<h1>KK 100 PCB ASSY</h1> <h2>4455 SERIES DWG</h2>	SHEET No.	
D15	ECM No.: 602687			- 4 -	
	DATE: 22/06/2018				
DOCUMENT NUMBER:	DOC TYPE:	DOC PART:	CREATED / REVISED BY:	CHECKED BY:	APPROVED BY:
SDA-4455	PSD	002	SS06	SS06	ISHWARG



# KK 100 PCB ASSY 2-20 CKT

## 4455 SERIES

Assy Proc:	RIGHT ANGLE
Hooks Cut:	NO
Housing No:	4455-N
Terminal No:	6516-4(565)
Dim C:	3.35 / .132
Plating:	565
Packaging:	PK-44646-001
Voids:	NONE

Assy Proc:	RIGHT ANGLE
Hooks Cut:	NO
Housing No:	4455-N
Terminal No:	6516-4(208)
Dim C:	3.35 / .132
Plating:	208
Packaging:	PK-44646-001
Voids:	NONE

Assy Proc:	BOTTOM ENTRY
Hooks Cut:	NO
Housing No:	4455-N2
Terminal No:	6516-3B(565)
Dim C:	3.35 / .132
Plating:	565
Packaging:	PK-44646-001
Voids:	NONE

Assy Proc:	BOTTOM ENTRY
Hooks Cut:	NO
Housing No:	4455-N2
Terminal No:	6516-3B(208)
Dim C:	3.35 / .132
Plating:	208
Packaging:	PK-44646-001
Voids:	NONE

Ckts
2
3
4
5
6
7
8
9
10
11
12
13
14
15
16
17
18
19
20

Material No	Engineer Number
22-16-2024	A-4455-AZ02B(565)
22-16-2034	A-4455-AZ 03 B(565)
22-16-2044	A-4455-AZ 04 B(565)
22-16-2054	A-4455-AZ 05 B(565)
22-16-2064	A-4455-AZ 06 B(565)
22-16-2074	A-4455-AZ 07 B(565)
22-16-2084	A-4455-AZ 08 B(565)
22-16-2094	A-4455-AZ 09 B(565)
22-16-2104	A-4455-AZ 10 B(565)
22-16-2114	A-4455-AZ 11 B(565)
22-16-2124	A-4455-AZ 12 B(565)
22-16-2134	A-4455-AZ 13 B(565)
22-16-2144	A-4455-AZ 14 B(565)
22-16-2154	A-4455-AZ 15 B(565)
22-16-2164	A-4455-AZ 16 B(565)
22-16-2174	A-4455-AZ 17 B(565)
22-16-2184	A-4455-AZ 18 B(565)
22-16-2194	A-4455-AZ 19 B(565)
22-16-2204	A-4455-AZ 20 B(565)

Material No	Engineer Number
	A-4455-AZ02B(208)
	A-4455-AZ 03 B(208)
	A-4455-AZ 04 B(208)
	A-4455-AZ 05 B(208)
	A-4455-AZ 06 B(208)
	A-4455-AZ 07 B(208)
	A-4455-AZ 08 B(208)
	A-4455-AZ 09 B(208)
	A-4455-AZ 10 B(208)
	A-4455-AZ 11 B(208)
	A-4455-AZ 12 B(208)
	A-4455-AZ 13 B(208)
	A-4455-AZ 14 B(208)
	A-4455-AZ 15 B(208)
	A-4455-AZ 16 B(208)
	A-4455-AZ 17 B(208)
	A-4455-AZ 18 B(208)
	A-4455-AZ 19 B(208)
	A-4455-AZ 20 B(208)

Material No	Engineer Number
22-17-2021	A-4455-BH02J(565)
22-17-2031	A-4455-BH 03 J(565)
22-17-2041	A-4455-BH 04 J(565)
22-17-2051	A-4455-BH 05 J(565)
22-17-2061	A-4455-BH 06 J(565)
22-17-2071	A-4455-BH 07 J(565)
22-17-2081	A-4455-BH 08 J(565)
22-17-2091	A-4455-BH 09 J(565)
22-17-2101	A-4455-BH 10 J(565)
22-17-2111	A-4455-BH 11 J(565)
22-17-2121	A-4455-BH 12 J(565)
22-17-2131	A-4455-BH 13 J(565)
22-17-2141	A-4455-BH 14 J(565)
22-17-2151	A-4455-BH 15 J(565)
22-17-2161	A-4455-BH 16 J(565)
22-17-2171	A-4455-BH 17 J(565)
22-17-2181	A-4455-BH 18 J(565)
22-17-2191	A-4455-BH 19 J(565)
22-17-2201	A-4455-BH 20 J(565)

Material No	Engineer Number
	A-4455-BH02J(208)
	A-4455-BH 03 J(208)
	A-4455-BH 04 J(208)
	A-4455-BH 05 J(208)
	A-4455-BH 06 J(208)
	A-4455-BH 07 J(208)
	A-4455-BH 08 J(208)
	A-4455-BH 09 J(208)
	A-4455-BH 10 J(208)
	A-4455-BH 11 J(208)
	A-4455-BH 12 J(208)
	A-4455-BH 13 J(208)
	A-4455-BH 14 J(208)
	A-4455-BH 15 J(208)
	A-4455-BH 16 J(208)
	A-4455-BH 17 J(208)
	A-4455-BH 18 J(208)
	A-4455-BH 19 J(208)
	A-4455-BH 20 J(208)

REV:	<b>ECM INFORMATION:</b>	TITLE:	<h1 style="margin: 0;">KK 100 PCB ASSY</h1> <h2 style="margin: 0;">4455 SERIES DWG</h2>		SHEET No.
D15	ECM No.: 602687				- 5 -
	DATE: 22/06/2018				
DOCUMENT NUMBER:	DOC TYPE:	DOC PART:	CREATED / REVISED BY:	CHECKED BY:	APPROVED BY:
SDA-4455	PSD	002	SS06	SS06	ISHWARG



# KK 100 PCB ASSY 2-20 CKT

## 4455 SERIES

Assy Proc:	TOP ENTRY
Hooks Cut:	NO
Housing No:	4455-N
Terminal No:	6516-4(P909)
Dim C:	3.35 / .132
Plating:	P909
Packaging:	PK-44646-001
Voids:	NONE

Assy Proc:	TOP ENTRY
Hooks Cut:	NO
Housing No:	4455-N
Terminal No:	6516-4(565)
Dim C:	3.35 / .132
Plating:	565
Packaging:	PK-44646-001
Voids:	NONE

Assy Proc:	TOP ENTRY
Hooks Cut:	NO
Housing No:	4455-N
Terminal No:	6516-4(208)
Dim C:	3.35 / .132
Plating:	208
Packaging:	PK-44646-001
Voids:	NONE

Ckts
2
3
4
5
6
7
8
9
10
11
12
13
14
15
16
17
18
19
20

Material No	Engineer Number
	A-4455-CZ02B(P909)
	A-4455-CZ 03 B(P909)
	A-4455-CZ 04 B(P909)
	A-4455-CZ 05 B(P909)
	A-4455-CZ 06 B(P909)
	A-4455-CZ 07 B(P909)
	A-4455-CZ 08 B(P909)
	A-4455-CZ 09 B(P909)
	A-4455-CZ 10 B(P909)
	A-4455-CZ 11 B(P909)
	A-4455-CZ 12 B(P909)
	A-4455-CZ 13 B(P909)
	A-4455-CZ 14 B(P909)
	A-4455-CZ 15 B(P909)
	A-4455-CZ 16 B(P909)
	A-4455-CZ 17 B(P909)
	A-4455-CZ 18 B(P909)
	A-4455-CZ 19 B(P909)
	A-4455-CZ 20 B(P909)

Material No	Engineer Number
22-18-2022	A-4455-CZ02B(565)
22-18-2032	A-4455-CZ 03 B(565)
22-18-2042	A-4455-CZ 04 B(565)
22-18-2052	A-4455-CZ 05 B(565)
22-18-2062	A-4455-CZ 06 B(565)
22-18-2072	A-4455-CZ 07 B(565)
22-18-2082	A-4455-CZ 08 B(565)
22-18-2092	A-4455-CZ 09 B(565)
22-18-2102	A-4455-CZ 10 B(565)
22-18-2112	A-4455-CZ 11 B(565)
22-18-2122	A-4455-CZ 12 B(565)
22-18-2132	A-4455-CZ 13 B(565)
22-18-2142	A-4455-CZ 14 B(565)
22-18-2152	A-4455-CZ 15 B(565)
22-18-2162	A-4455-CZ 16 B(565)
22-18-2172	A-4455-CZ 17 B(565)
22-18-2182	A-4455-CZ 18 B(565)
22-18-2192	A-4455-CZ 19 B(565)
22-18-2202	A-4455-CZ 20 B(565)

Material No	Engineer Number
	A-4455-CZ02B(208)
	A-4455-CZ 03B(208)
	A-4455-CZ 04 B(208)
	A-4455-CZ 05 B(208)
	A-4455-CZ 06 B(208)
	A-4455-CZ 07 B(208)
	A-4455-CZ 08 B(208)
	A-4455-CZ 09 B(208)
	A-4455-CZ 10 B(208)
	A-4455-CZ 11 B(208)
	A-4455-CZ 12 B(208)
	A-4455-CZ 13 B(208)
	A-4455-CZ 14 B(208)
	A-4455-CZ 15 B(208)
	A-4455-CZ 16 B(208)
	A-4455-CZ 17 B(208)
	A-4455-CZ 18 B(208)
	A-4455-CZ 19 B(208)
	A-4455-CZ 20 B(208)

REV:	<b>ECM INFORMATION:</b>	TITLE:	<h1 style="margin: 0;">KK 100 PCB ASSY</h1> <h2 style="margin: 0;">4455 SERIES DWG</h2>		SHEET No.
D15	ECM No.: 602687				- 6 -
	DATE: 22/06/2018				
DOCUMENT NUMBER:	DOC TYPE:	DOC PART:	CREATED / REVISED BY:	CHECKED BY:	APPROVED BY:
SDA-4455	PSD	002	SS06	SS06	ISHWARG



# KK 100 PCB ASSY 2-20 CKT

## 4455 SERIES

Assy Proc:	RIGHT ANGLE
Hooks Cut:	NO
Housing No:	4455-BN
Terminal No:	4316-4(228)
Dim C:	3.35 / .132
Plating:	228
Packaging:	PK-44646-002
Voids:	NONE

Assy Proc:	RIGHT ANGLE
Hooks Cut:	NO
Housing No:	4455-BN
Terminal No:	4316-4(P909)
Dim C:	3.35 / .132
Plating:	P909
Packaging:	PK-44646-002
Voids:	NONE

Ckts	Material No	Engineer Number
2		A-4455-AB02A(228)
3		A-4455-AB 03 A(228)
4		A-4455-AB 04 A(228)
5		A-4455-AB 05 A(228)
6	50-34-8518	A-4455-AB 06 A(228)
7		A-4455-AB 07 A(228)
8		A-4455-AB 08 A(228)
9		A-4455-AB 09 A(228)
10		A-4455-AB 10 A(228)
11		A-4455-AB 11 A(228)
12		A-4455-AB 12 A(228)
13		A-4455-AB 13 A(228)
14		A-4455-AB 14 A(228)
15		A-4455-AB 15 A(228)
16		A-4455-AB 16 A(228)
17		A-4455-AB 17 A(228)
18		A-4455-AB 18 A(228)
19		A-4455-AB 19 A(228)
20		A-4455-AB 20 A(228)

Material No	Engineer Number
22-15-4024	A-4455-AB02A(P909)
22-15-4034	A-4455-AB 03A(P909)
22-15-4044	A-4455-AB 04A(P909)
22-15-4054	A-4455-AB 05A(P909)
22-15-4064	A-4455-AB 06A(P909)
22-15-4074	A-4455-AB 07A(P909)
22-15-4084	A-4455-AB 08A(P909)
22-15-4094	A-4455-AB 09A(P909)
22-15-4104	A-4455-AB 10A(P909)
22-15-4114	A-4455-AB 11A(P909)
22-15-4124	A-4455-AB 12A(P909)
22-15-4134	A-4455-AB 13A(P909)
22-15-4144	A-4455-AB 14A(P909)
22-15-4154	A-4455-AB 15A(P909)
22-15-4164	A-4455-AB 16A(P909)
22-15-4174	A-4455-AB 17A(P909)
22-15-4184	A-4455-AB 18A(P909)
22-15-4194	A-4455-AB 19A(P909)
22-15-4204	A-4455-AB 20A(P909)

<b>REV:</b>	<b>ECM INFORMATION:</b>	<b>TITLE:</b>	<b>SHEET No.</b>		
<b>D15</b>	ECM No.: <b>602687</b>	<b>KK 100 PCB ASSY 4455 SERIES DWG</b>	<b>- 7 -</b>		
	DATE: <b>22/06/2018</b>				
<b>DOCUMENT NUMBER:</b>	<b>DOC TYPE:</b>	<b>DOC PART:</b>	<b>CREATED / REVISED BY:</b>	<b>CHECKED BY:</b>	<b>APPROVED BY:</b>
<b>SDA-4455</b>	<b>PSD</b>	<b>002</b>	<b>SS06</b>	<b>SS06</b>	<b>ISHWARG</b>



# KK 100 PCB ASSY 2-20 CKT

## 4455 SERIES

Ckts	Assy Proc: RIGHT ANGLE		Assy Proc: RIGHT ANGLE		Assy Proc: RIGHT ANGLE		Assy Proc: RIGHT ANGLE	
	Material No	Engineer Number	Material No	Engineer Number	Material No	Engineer Number	Material No	Engineer Number
	Hooks Cut:	NO	Hooks Cut:	NO	Hooks Cut:	NO	Hooks Cut:	NO
	Housing No:	4455-NR	Housing No:	4455-N	Housing No:	4455-N	Housing No:	4455-N
	Terminal No:	4316-4(P909)	Terminal No:	4316-4(228)	Terminal No:	6516-4(228)	Terminal No:	6516-4(228)
	Dim C:	3.35 / .132	Dim C:	3.35 / .132	Dim C:	3.35 / .132	Dim C:	3.35 / .132
	Plating:	P909	Plating:	228	Plating:	228	Plating:	228
	Packaging:	PK-44646-001	Packaging:	PK-44646-001	Packaging:	PK-44646-001	Packaging:	PK-44646-001
	Voids:	NONE	Voids:	NONE	Voids:	NONE	Voids:	NONE
2	22-15-4022	A-4455-AR02A(P909)		A-4455-AZ02A(228)	22-17-5023	A-4455-AZ02B(228)	22-16-2022	A-4455-AZ02B(228)
3	22-15-4032	A-4455-AR 03 A(P909)		A-4455-AZ 03 A(228)	22-17-5033	A-4455-AZ 03 B(228)	22-16-2032	A-4455-AZ 03 B(228)
4	22-15-4042	A-4455-AR 04 A(P909)		A-4455-AZ 04 A(228)	22-17-5043	A-4455-AZ 04 B(228)	22-16-2042	A-4455-AZ 04 B(228)
5	22-15-4052	A-4455-AR 05 A(P909)		A-4455-AZ 05 A(228)	22-17-5053	A-4455-AZ 05 B(228)	22-16-2052	A-4455-AZ 05 B(228)
6	22-15-4062	A-4455-AR 06 A(P909)		A-4455-AZ 06 A(228)	22-17-5063	A-4455-AZ 06 B(228)	22-16-2062	A-4455-AZ 06 B(228)
7	22-15-4072	A-4455-AR 07 A(P909)		A-4455-AZ 07 A(228)	22-17-5073	A-4455-AZ 07 B(228)	22-16-2072	A-4455-AZ 07 B(228)
8	22-15-4082	A-4455-AR 08 A(P909)		A-4455-AZ 08 A(228)	22-17-5083	A-4455-AZ 08 B(228)	22-16-2082	A-4455-AZ 08 B(228)
9	22-15-4092	A-4455-AR 09 A(P909)		A-4455-AZ 09 A(228)	22-17-5093	A-4455-AZ 09 B(228)	22-16-2092	A-4455-AZ 09 B(228)
10	22-15-4102	A-4455-AR 10 A(P909)		A-4455-AZ 10 A(228)	22-17-5103	A-4455-AZ 10 B(228)	22-16-2102	A-4455-AZ 10 B(228)
11	22-15-4112	A-4455-AR 11 A(P909)		A-4455-AZ 11 A(228)	22-17-5113	A-4455-AZ 11 B(228)	22-16-2112	A-4455-AZ 11 B(228)
12	22-15-4122	A-4455-AR 12 A(P909)		A-4455-AZ 12 A(228)	22-17-5123	A-4455-AZ 12 B(228)	22-16-2122	A-4455-AZ 12 B(228)
13	22-15-4132	A-4455-AR 13 A(P909)		A-4455-AZ 13 A(228)	22-17-5133	A-4455-AZ 13 B(228)	22-16-2132	A-4455-AZ 13 B(228)
14	22-15-4142	A-4455-AR 14 A(P909)		A-4455-AZ 14 A(228)	22-17-5143	A-4455-AZ 14 B(228)	22-16-2142	A-4455-AZ 14 B(228)
15	22-15-4152	A-4455-AR 15 A(P909)		A-4455-AZ 15 A(228)	22-17-5153	A-4455-AZ 15 B(228)	22-16-2152	A-4455-AZ 15 B(228)
16	22-15-4162	A-4455-AR 16 A(P909)		A-4455-AZ 16 A(228)	22-17-5163	A-4455-AZ 16 B(228)	22-16-2162	A-4455-AZ 16 B(228)
17	22-15-4172	A-4455-AR 17 A(P909)		A-4455-AZ 17 A(228)	22-17-5173	A-4455-AZ 17 B(228)	22-16-2172	A-4455-AZ 17 B(228)
18	22-15-4182	A-4455-AR 18 A(P909)		A-4455-AZ 18 A(228)	22-17-5183	A-4455-AZ 18 B(228)	22-16-2182	A-4455-AZ 18 B(228)
19	22-15-4192	A-4455-AR 19 A(P909)		A-4455-AZ 19 A(228)	22-17-5193	A-4455-AZ 19 B(228)	22-16-2192	A-4455-AZ 19 B(228)
20	22-15-4202	A-4455-AR 20 A(P909)	22-17-5201	A-4455-AZ 20 A(228)	22-17-5203	A-4455-AZ 20 B(228)	22-16-2202	A-4455-AZ 20 B(228)

REV:	<b>ECM INFORMATION:</b>	<u>TITLE:</u>	<b>KK 100 PCB ASSY 4455 SERIES DWG</b>	<u>SHEET No.</u>	
<b>D15</b>	ECM No.: <b>602687</b>			<b>- 8 -</b>	
	DATE: <b>22/06/2018</b>				
<u>DOCUMENT NUMBER:</u>	<u>DOC TYPE:</u>	<u>DOC PART:</u>	<u>CREATED / REVISED BY:</u>	<u>CHECKED BY:</u>	<u>APPROVED BY:</u>
<b>SDA-4455</b>	<b>PSD</b>	<b>002</b>	<b>SS06</b>	<b>SS06</b>	<b>ISHWARG</b>





# KK 100 PCB ASSY 2-20 CKT

## 4455 SERIES

	Assy Proc:	BOTTOM ENTRY	Assy Proc:	BOTTOM ENTRY	Assy Proc:	BOTTOM ENTRY	Assy Proc:	BOTTOM ENTRY
	Hooks Cut:	NO	Hooks Cut:	NO	Hooks Cut:	NO	Hooks Cut:	NO
	Housing No:	4455-N2	Housing No:	4455-N2	Housing No:	4455-N2	Housing No:	4455-N2
	Terminal No:	4316-3B(228)	Terminal No:	4316-3B(231)	Terminal No:	4316-3B(228)	Terminal No:	6516-3B(228)
	Dim C:	3.35 / .132	Dim C:	3.35 / .132	Dim C:	3.35 / .132	Dim C:	3.35 / .132
	Plating:	228	Plating:	231	Plating:	228	Plating:	228
	Packaging:	PK-44646-001	Packaging:	PK-44646-001	Packaging:	PK-44646-001	Packaging:	PK-44646-001
	Voids:	NO	Voids:	NO	Voids:	NO	Voids:	NO
Ckts	Material No	Engineer Number	Material No	Engineer Number	Material No	Engineer Number	Material No	Engineer Number
2	22-17-2024	A-4455-BH02D(228)		A-4455-BH02D(231)		A-4455-BH02D(228)	22-17-2027	A-4455-BH02J(228)
3	22-17-2034	A-4455-BH03D(228)		A-4455-BH 03 D(231)		A-4455-BH03D(228)	22-17-2037	A-4455-BH03J(228)
4	22-17-2044	A-4455-BH04D(228)		A-4455-BH 04 D(231)		A-4455-BH04D(228)	22-17-2047	A-4455-BH04J(228)
5	22-17-2054	A-4455-BH05D(228)		A-4455-BH 05 D(231)	22-17-3056	A-4455-BH05D(228)	22-17-2057	A-4455-BH05J(228)
6	22-17-2064	A-4455-BH06D(228)		A-4455-BH 06 D(231)	22-17-3066	A-4455-BH06D(228)	22-17-2067	A-4455-BH06J(228)
7	22-17-2074	A-4455-BH07D(228)		A-4455-BH 07 D(231)		A-4455-BH07D(228)	22-17-2077	A-4455-BH07J(228)
8	22-17-2084	A-4455-BH08D(228)		A-4455-BH 08 D(231)	22-17-3086	A-4455-BH08D(228)	22-17-2087	A-4455-BH08J(228)
9	22-17-2094	A-4455-BH09D(228)		A-4455-BH 09 D(231)		A-4455-BH09D(228)	22-17-2097	A-4455-BH09J(228)
10	22-17-2104	A-4455-BH10D(228)		A-4455-BH 10 D(231)		A-4455-BH10D(228)	22-17-2107	A-4455-BH10J(228)
11	22-17-2114	A-4455-BH11D(228)		A-4455-BH 11 D(231)		A-4455-BH11D(228)	22-17-2117	A-4455-BH11J(228)
12	22-17-2124	A-4455-BH12D(228)		A-4455-BH 12 D(231)		A-4455-BH12D(228)	22-17-2127	A-4455-BH12J(228)
13	22-17-2134	A-4455-BH13D(228)		A-4455-BH 13 D(231)		A-4455-BH13D(228)	22-17-2137	A-4455-BH13J(228)
14	22-17-2144	A-4455-BH14D(228)	22-17-2140	A-4455-BH 14 D(231)	22-17-3146	A-4455-BH14D(228)	22-17-2147	A-4455-BH14J(228)
15	22-17-2154	A-4455-BH15D(228)		A-4455-BH 15 D(231)		A-4455-BH15D(228)	22-17-2157	A-4455-BH15J(228)
16	22-17-2164	A-4455-BH16D(228)		A-4455-BH 16 D(231)		A-4455-BH16D(228)	22-17-2167	A-4455-BH16J(228)
17	22-17-2174	A-4455-BH17D(228)		A-4455-BH 17 D(231)		A-4455-BH17D(228)	22-17-2177	A-4455-BH17J(228)
18	22-17-2184	A-4455-BH18D(228)		A-4455-BH 18 D(231)		A-4455-BH18D(228)	22-17-2187	A-4455-BH18J(228)
19	22-17-2194	A-4455-BH19D(228)		A-4455-BH 19 D(231)	22-17-3196	A-4455-BH19D(228)	22-17-2197	A-4455-BH19J(228)
20	22-17-2204	A-4455-BH20D(228)	22-17-2200	A-4455-BH 20 D(231)	22-17-3206	A-4455-BH20D(228)	22-17-2207	A-4455-BH20J(228)

REV:	<b>ECM INFORMATION:</b>	<u>TITLE:</u>	<b>KK 100 PCB ASSY 4455 SERIES DWG</b>		<u>SHEET No.</u>
<b>D15</b>	ECM No.: <b>602687</b>				<b>- 9 -</b>
	DATE: <b>22/06/2018</b>				
<u>DOCUMENT NUMBER:</u>	<u>DOC TYPE:</u>	<u>DOC PART:</u>	<u>CREATED / REVISED BY:</u>	<u>CHECKED BY:</u>	<u>APPROVED BY:</u>
<b>SDA-4455</b>	<b>PSD</b>	<b>002</b>	<b>SS06</b>	<b>SS06</b>	<b>ISHWARG</b>



# KK 100 PCB ASSY 2-20 CKT

## 4455 SERIES

Ckts	Assy Proc: TOP ENTRY		Assy Proc: TOP ENTRY		Assy Proc: TOP ENTRY		Assy Proc: TOP ENTRY	
	Material No	Engineer Number	Material No	Engineer Number	Material No	Engineer Number	Material No	Engineer Number
2		A-4455-CP02A(208)	22-18-2026	A-4455-CY02A(565)	22-02-7023	A-4455-CY02A(P909)	22-15-4028	A-4455-CB02A(P909)
3		A-4455-CP 03 A(208)	22-18-2036	A-4455-CY 03 A(565)	22-02-7033	A-4455-CY 03A(P909)	22-15-4038	A-4455-CB 03A(P909)
4		A-4455-CP 04 A(208)	22-18-2046	A-4455-CY 04 A(565)	22-02-7043	A-4455-CY 04A(P909)	22-15-4048	A-4455-CB 04A(P909)
5	22-18-2057	A-4455-CP 05 A(208)	22-18-2056	A-4455-CY 05 A(565)	22-02-7053	A-4455-CY 05A(P909)	22-15-4058	A-4455-CB 05A(P909)
6		A-4455-CP 06 A(208)	22-18-2066	A-4455-CY 06 A(565)	22-02-7063	A-4455-CY 06A(P909)	22-15-4068	A-4455-CB 06A(P909)
7		A-4455-CP 07 A(208)	22-18-2076	A-4455-CY 07 A(565)	22-02-7073	A-4455-CY 07A(P909)	22-15-4078	A-4455-CB 07A(P909)
8		A-4455-CP 08 A(208)	22-18-2086	A-4455-CY 08 A(565)	22-02-7083	A-4455-CY 08A(P909)	22-15-4088	A-4455-CB 08A(P909)
9		A-4455-CP 09 A(208)	22-18-2096	A-4455-CY 09 A(565)	22-02-7093	A-4455-CY 09A(P909)	22-15-4098	A-4455-CB 09A(P909)
10		A-4455-CP 10 A(208)	22-18-2106	A-4455-CY 10 A(565)	22-02-7103	A-4455-CY 10A(P909)	22-15-4108	A-4455-CB 10A(P909)
11		A-4455-CP 11 A(208)	22-18-2116	A-4455-CY 11 A(565)	22-02-7113	A-4455-CY 11A(P909)	22-15-4118	A-4455-CB 11A(P909)
12		A-4455-CP 12 A(208)	22-18-2126	A-4455-CY 12 A(565)	22-02-7123	A-4455-CY 12A(P909)	22-15-4128	A-4455-CB 12A(P909)
13		A-4455-CP 13 A(208)	22-18-2136	A-4455-CY 13 A(565)	22-02-7133	A-4455-CY 13A(P909)	22-15-4138	A-4455-CB 13A(P909)
14		A-4455-CP 14 A(208)	22-18-2146	A-4455-CY 14 A(565)	22-02-7143	A-4455-CY 14A(P909)	22-15-4148	A-4455-CB 14A(P909)
15		A-4455-CP 15 A(208)	22-18-2156	A-4455-CY 15 A(565)	22-02-7153	A-4455-CY 15A(P909)	22-15-4158	A-4455-CB 15A(P909)
16		A-4455-CP 16 A(208)	22-18-2166	A-4455-CY 16 A(565)	22-02-7163	A-4455-CY 16A(P909)	22-15-4168	A-4455-CB 16A(P909)
17		A-4455-CP 17 A(208)	22-18-2176	A-4455-CY 17 A(565)	22-02-7173	A-4455-CY 17A(P909)	22-15-4178	A-4455-CB 17A(P909)
18		A-4455-CP 18 A(208)	22-18-2186	A-4455-CY 18 A(565)	22-02-7183	A-4455-CY 18A(P909)	22-15-4188	A-4455-CB 18A(P909)
19		A-4455-CP 19 A(208)	22-18-2196	A-4455-CY 19 A(565)	22-02-7193	A-4455-CY 19A(P909)	22-15-4198	A-4455-CB 19A(P909)
20		A-4455-CP 20 A(208)	22-18-2206	A-4455-CY 20 A(565)	22-02-7203	A-4455-CY 20A(P909)	22-15-4208	A-4455-CB 20A(P909)

REV:	<b>ECM INFORMATION:</b>	<u>TITLE:</u>	<b>KK 100 PCB ASSY 4455 SERIES DWG</b>	<u>SHEET No.</u>	
<b>D15</b>	ECM No.: <b>602687</b>			<b>- 10 -</b>	
	DATE: <b>22/06/2018</b>				
<u>DOCUMENT NUMBER:</u>	<u>DOC TYPE:</u>	<u>DOC PART:</u>	<u>CREATED / REVISED BY:</u>	<u>CHECKED BY:</u>	<u>APPROVED BY:</u>
<b>SDA-4455</b>	<b>PSD</b>	<b>002</b>	<b>SS06</b>	<b>SS06</b>	<b>ISHWARG</b>



# KK 100 PCB ASSY 2-20 CKT

## 4455 SERIES

Ckts	Assy Proc: TOP ENTRY		Assy Proc: TOP ENTRY		Assy Proc: TOP ENTRY		Assy Proc: TOP ENTRY	
	Material No	Engineer Number	Material No	Engineer Number	Material No	Engineer Number	Material No	Engineer Number
2	22-65-3020	A-4455-CR02A(P909)	22-18-2024	A-4455-CZ02B(228)	22-18-7023	A-4455-CY02A(208)	22-18-7021	A-4455-CY02B(228)
3	22-65-3030	A-4455-CR 03A(P909)	22-18-2034	A-4455-CZ 03 B(228)	22-18-7033	A-4455-CY 03 A(208)	22-18-7031 38-00-1478	A-4455-CY 03 B(228)
4	22-65-3040	A-4455-CR 04A(P909)	22-18-2044	A-4455-CZ 04 B(228)	22-18-7043	A-4455-CY 04 A(208)	22-18-7041	A-4455-CY 04 B(228)
5	22-65-3050	A-4455-CR 05A(P909)	22-18-2054	A-4455-CZ 05 B(228)	22-18-7053	A-4455-CY 05 A(208)	22-18-7051	A-4455-CY 05 B(228)
6	22-65-3060	A-4455-CR 06A(P909)	22-18-2064	A-4455-CZ 06 B(228)	22-18-7063	A-4455-CY 06 A(208)	22-18-7061	A-4455-CY 06 B(228)
7	22-65-3070	A-4455-CR 07A(P909)	22-18-2074	A-4455-CZ 07 B(228)	22-18-7073	A-4455-CY 07 A(208)	22-18-7071	A-4455-CY 07 B(228)
8	22-65-3080	A-4455-CR 08A(P909)	22-18-2084	A-4455-CZ 08 B(228)	22-18-7083	A-4455-CY 08 A(208)	22-18-7081	A-4455-CY 08 B(228)
9	22-65-3090	A-4455-CR 09A(P909)	22-18-2094	A-4455-CZ 09 B(228)	22-18-7093	A-4455-CY 09 A(208)	22-18-7091	A-4455-CY 09 B(228)
10	22-65-3100	A-4455-CR 10A(P909)	22-18-2104	A-4455-CZ 10 B(228)	22-18-7103	A-4455-CY 10 A(208)	22-18-7101	A-4455-CY 10 B(228)
11	22-65-3110	A-4455-CR 11A(P909)	22-18-2114	A-4455-CZ 11 B(228)	22-18-7113	A-4455-CY 11 A(208)	22-18-7111	A-4455-CY 11 B(228)
12	22-65-3120	A-4455-CR 12A(P909)	22-18-2124	A-4455-CZ 12 B(228)	22-18-7123	A-4455-CY 12 A(208)	22-18-7121	A-4455-CY 12 B(228)
13	22-65-3130	A-4455-CR 13A(P909)	22-18-2134	A-4455-CZ 13 B(228)	22-18-7133	A-4455-CY 13 A(208)	22-18-7131	A-4455-CY 13 B(228)
14	22-65-3140	A-4455-CR 14A(P909)	22-18-2144	A-4455-CZ 14 B(228)	22-18-7143	A-4455-CY 14 A(208)	22-18-7141	A-4455-CY 14 B(228)
15	22-65-3150	A-4455-CR 15A(P909)	22-18-2154	A-4455-CZ 15 B(228)	22-18-7153	A-4455-CY 15 A(208)	22-18-7151	A-4455-CY 15 B(228)
16	22-65-3160	A-4455-CR 16A(P909)	22-18-2164	A-4455-CZ 16 B(228)	22-18-7163	A-4455-CY 16 A(208)	22-18-7161	A-4455-CY 16 B(228)
17	22-65-3170	A-4455-CR 17A(P909)	22-18-2174	A-4455-CZ 17 B(228)	22-18-7173	A-4455-CY 17 A(208)	22-18-7171	A-4455-CY 17 B(228)
18	22-65-3180	A-4455-CR 18A(P909)	22-18-2184	A-4455-CZ 18 B(228)	22-18-7183	A-4455-CY 18 A(208)	22-18-7181	A-4455-CY 18 B(228)
19	22-65-3190	A-4455-CR 19A(P909)	22-18-2194	A-4455-CZ 19 B(228)	22-18-7193	A-4455-CY 19 A(208)	22-18-7191	A-4455-CY 19 B(228)
20	22-65-3200	A-4455-CR 20A(P909)	22-18-2204	A-4455-CZ 20 B(228)	22-18-7203	A-4455-CY 20 A(208)	22-18-7201	A-4455-CY 20 B(228)

REV:	<b>ECM INFORMATION:</b>	<u>TITLE:</u>	<u>SHEET No.</u>
<b>D15</b>	ECM No.: <b>602687</b>	<b>KK 100 PCB ASSY 4455 SERIES DWG</b>	<b>- 11 -</b>
	DATE: <b>22/06/2018</b>		
<u>DOCUMENT NUMBER:</u>	<u>DOC TYPE:</u>	<u>DOC PART:</u>	<u>CREATED / REVISED BY:</u>
<b>SDA-4455</b>	<b>PSD</b>	<b>002</b>	<b>SS06</b>
<u>CHECKED BY:</u>		<u>APPROVED BY:</u>	
<b>SS06</b>		<b>ISHWARG</b>	



# KK 100 PCB ASSY 2-20 CKT

## 4455 SERIES

Assy Proc:	RIGHT ANGLE
Hooks Cut:	NO
Housing No:	4455-N
Terminal No:	6516-5C(P909)
Dim C:	3.35±1.00/.132±.039
Plating:	P909
Packaging:	PK-44646-001
Voids:	NO

Assy Proc:	BOTTOM ENTRY
Hooks Cut:	NO
Housing No:	4455-N2
Terminal No:	6516-6C(P909)
Dim C:	3.61±1.00/.142±.039
Plating:	P909
Packaging:	PK-44646-001
Voids:	NO

Ckts	Material No	Engineer Number
2	38-00-1332	A-4455-AZ02C(P909)
3	38-00-1333	A-4455-AZ03C(P909)
4	38-00-1334	A-4455-AZ04C(P909)
5	38-00-1335	A-4455-AZ05C(P909)
6	38-00-1336	A-4455-AZ06C(P909)
7	38-00-1337	A-4455-AZ07C(P909)
8	38-00-1338	A-4455-AZ08C(P909)
9	38-00-1339	A-4455-AZ09C(P909)
10	38-00-1340	A-4455-AZ10C(P909)
11	38-00-1341	A-4455-AZ11C(P909)
12	38-00-1342	A-4455-AZ12C(P909)
13	38-00-1343	A-4455-AZ13C(P909)
14	38-00-1344	A-4455-AZ14C(P909)
15	38-00-1345	A-4455-AZ15C(P909)
16	38-00-1346	A-4455-AZ16C(P909)
17	38-00-1347	A-4455-AZ17C(P909)
18	38-00-1348	A-4455-AZ18C(P909)
19	38-00-1349	A-4455-AZ19C(P909)
20	38-00-1350	A-4455-AZ20C(P909)

Material No	Engineer Number
38-00-1392	A-4455-BH02F(P909)
38-00-1393	A-4455-BH03F(P909)
38-00-1394	A-4455-BH04F(P909)
38-00-1395	A-4455-BH05F(P909)
38-00-1396	A-4455-BH06F(P909)
38-00-1397	A-4455-BH07F(P909)
38-00-1398	A-4455-BH08F(P909)
38-00-1399	A-4455-BH09F(P909)
38-00-1400	A-4455-BH10F(P909)
38-00-1401	A-4455-BH11F(P909)
38-00-1402	A-4455-BH12F(P909)
38-00-1403	A-4455-BH13F(P909)
38-00-1404	A-4455-BH14F(P909)
38-00-1405	A-4455-BH15F(P909)
38-00-1406	A-4455-BH16F(P909)
38-00-1407	A-4455-BH17F(P909)
38-00-1408	A-4455-BH18F(P909)
38-00-1409	A-4455-BH19F(P909)
38-00-1410	A-4455-BH20F(P909)

REV:	<b>ECM INFORMATION:</b>	<u>TITLE:</u>	<u>SHEET No.</u>		
<b>D15</b>	ECM No.: <b>602687</b>	<b>KK 100 PCB ASSY 4455 SERIES DWG</b>	<b>- 12 -</b>		
	DATE: <b>22/06/2018</b>				
<u>DOCUMENT NUMBER:</u>	<u>DOC TYPE:</u>	<u>DOC PART:</u>	<u>CREATED / REVISED BY:</u>	<u>CHECKED BY:</u>	<u>APPROVED BY:</u>
<b>SDA-4455</b>	<b>PSD</b>	<b>002</b>	<b>SS06</b>	<b>SS06</b>	<b>ISHWARG</b>



# KK 100 PCB ASSY 2-20 CKT

## 4455 SERIES

Assy Proc:	RIGHT ANGLE
Hooks Cut:	NO
Housing No:	4455-BN
Terminal No:	4316-4(565)
Dim C:	3.35 / .132
Plating:	565
Packaging:	PK-44646-002
Voids:	NO

Assy Proc:	TOP ENTRY
Hooks Cut:	NO
Housing No:	4455-N
Terminal No:	6516-5C(P909)
Dim C:	3.35±1.00/.132±.039
Plating:	P909
Packaging:	PK-44646-001
Voids:	NO

Assy Proc:	TOP ENTRY
Hooks Cut:	YES
Housing No:	4455-N-02
Terminal No:	4316-4(P909)
Dim C:	3.35 / .132
Plating:	P909
Packaging:	PK-44646-003
Voids:	YES IN CKT 2

Ckts	Material No	Engineer Number	Material No	Engineer Number	Material No	Engineer Number
2	22-16-3028	A-4455-AB02A(565)	38-00-1422	A-4455-CZ02C(P909)		
3	22-16-3038	A-4455-AB 03 A(565)	38-00-1423	A-4455-CZ03C(P909)		
4	22-16-3048	A-4455-AB 04 A(565)	38-00-1424	A-4455-CZ04C(P909)		
5	22-16-3058	A-4455-AB 05 A(565)	38-00-1425	A-4455-CZ05C(P909)		
6	22-16-3068	A-4455-AB 06 A(565)	38-00-1426	A-4455-CZ06C(P909)	22-02-3068	A-4455-CW06A(P909)-2
7	22-16-3078	A-4455-AB 07 A(565)	38-00-1427	A-4455-CZ07C(P909)	50-29-0004	A-4455-CW07A(P909)-2
8	22-16-3088	A-4455-AB 08 A(565)	38-00-1428	A-4455-CZ08C(P909)		
9	22-16-3098	A-4455-AB 09 A(565)	38-00-1429	A-4455-CZ09C(P909)		
10	22-16-3108	A-4455-AB 10 A(565)	38-00-1430	A-4455-CZ10C(P909)		
11	22-16-3118	A-4455-AB 11 A(565)	38-00-1431	A-4455-CZ11C(P909)		
12	22-16-3128	A-4455-AB 12 A(565)	38-00-1432	A-4455-CZ12C(P909)		
13	22-16-3138	A-4455-AB 13 A(565)	38-00-1433	A-4455-CZ13C(P909)		
14	22-16-3148	A-4455-AB 14 A(565)	38-00-1434	A-4455-CZ14C(P909)		
15	22-16-3158	A-4455-AB 15 A(565)	38-00-1435	A-4455-CZ15C(P909)		
16	22-16-3168	A-4455-AB 16 A(565)	38-00-1436	A-4455-CZ16C(P909)		
17	22-16-3178	A-4455-AB 17 A(565)	38-00-1437	A-4455-CZ17C(P909)		
18	22-16-3188	A-4455-AB 18 A(565)	38-00-1438	A-4455-CZ18C(P909)		
19	22-16-3198	A-4455-AB 19 A(565)	38-00-1439	A-4455-CZ19C(P909)		
20	22-16-3208	A-4455-AB 20 A(565)	38-00-1440	A-4455-CZ20C(P909)		

REV:	<b>ECM INFORMATION:</b>	TITLE:	<h1 style="margin: 0;">KK 100 PCB ASSY</h1> <h2 style="margin: 0;">4455 SERIES DWG</h2>	SHEET No.	
<b>D15</b>	ECM No.: 602687			<b>- 13 -</b>	
	DATE: 22/06/2018				
DOCUMENT NUMBER:	DOC TYPE:	DOC PART:	CREATED / REVISED BY:	CHECKED BY:	APPROVED BY:
<b>SDA-4455</b>	<b>PSD</b>	<b>002</b>	<b>SS06</b>	<b>SS06</b>	<b>ISHWARG</b>



# KK 100 PCB ASSY 2-20 CKT

## 4455 SERIES

Ckts	Assy Proc: TOP ENTRY		Assy Proc: TOP ENTRY		Assy Proc: BOTTOM ENTRY		Assy Proc: BOTTOM ENTRY	
	Material No	Engineer Number	Material No	Engineer Number	Material No	Engineer Number	Material No	Engineer Number
2		A-4455-CY02B(P909)						
3		A-4455-CY 03B(P909)						
4		A-4455-CY 04B(P909)						
5	50-29-1553	A-4455-CY 05B(P909)						
6	50-29-1554	A-4455-CY 06B(P909)	22-15-5065	A-4455-CY06A(P909)-2				
7		A-4455-CY 07B(P909)						
8		A-4455-CY 08B(P909)						
9		A-4455-CY 09B(P909)						
10		A-4455-CY 10B(P909)						
11		A-4455-CY 11B(P909)			50-36-1881	A-4455-BH11D(P909)-10		
12		A-4455-CY 12B(P909)						
13		A-4455-CY 13B(P909)					26-01-3099	A-4455-BH13D(208)-51
14		A-4455-CY 14B(P909)						
15		A-4455-CY 15B(P909)						
16		A-4455-CY 16B(P909)						
17		A-4455-CY 17B(P909)						
18		A-4455-CY 18B(P909)						
19		A-4455-CY 19B(P909)						
20		A-4455-CY 20B(P909)						

REV:	<b>ECM INFORMATION:</b>	<u>TITLE:</u>	<u>SHEET No.</u>
<b>D15</b>	ECM No.: <b>602687</b>	<b>KK 100 PCB ASSY 4455 SERIES DWG</b>	<b>- 14 -</b>
	DATE: <b>22/06/2018</b>		
<u>DOCUMENT NUMBER:</u>	<u>DOC TYPE:</u>	<u>DOC PART:</u>	<u>CREATED / REVISED BY:</u>
<b>SDA-4455</b>	<b>PSD</b>	<b>002</b>	<b>SS06</b>
<u>CHECKED BY:</u>		<u>APPROVED BY:</u>	
<b>SS06</b>		<b>ISHWARG</b>	



# KK 100 PCB ASSY 2-20 CKT

## 4455 SERIES

	Assy Proc:	RIGHT ANGLE	Assy Proc:	TOP ENTRY	Assy Proc:	TOP ENTRY	Assy Proc:	
	Hooks Cut:	NO	Hooks Cut:	YES	Hooks Cut:	YES	Hooks Cut:	
	Housing No:	4455-BN	Housing No:	4455-BN	Housing No:	4455-NR	Housing No:	
	Terminal No:	4316-4(P909)	Terminal No:	4316-4(P909)	Terminal No:	4316-4(P909)	Terminal No:	
	Dim C:	3.35 / .132	Dim C:	3.35 / .132	Dim C:	3.35 / .132	Dim C:	
	Plating:	P909	Plating:	P909	Plating:	P909	Plating:	
	Packaging:	PK-44646-002	Packaging:	PK-44646-006	Packaging:	PK-44646-003	Packaging:	
	Voids:	3,6,12,15	Voids:	NO	Voids:	NO	Voids:	
Ckts	Material No	Engineer Number	Material No	Engineer Number	Material No	Engineer Number	Material No	Engineer Number
2								
3			46999-0585	A-4455-CG03A(P909)				
4			46999-0583	A-4455-CG04A(P909)				
5								
6			46999-0584	A-4455-CG06A(P909)				
7								
8					46999-0599	A-4455-CP 08A(P909)		
9								
10								
11								
12								
13								
14			46999-0586	A-4455-CG14A(P909)				
15								
16								
17	46999-0582	A-4455-AB17A(P909)-51						
18								
19								
20								

REV:	<b>ECM INFORMATION:</b>	<u>TITLE:</u>	<b>KK 100 PCB ASSY 4455 SERIES DWG</b>		<u>SHEET No.</u>
<b>D15</b>	ECM No.: <b>602687</b>				<b>- 15 -</b>
	DATE: <b>22/06/2018</b>				
<u>DOCUMENT NUMBER:</u>	<u>DOC TYPE:</u>	<u>DOC PART:</u>	<u>CREATED / REVISED BY:</u>	<u>CHECKED BY:</u>	<u>APPROVED BY:</u>
<b>SDA-4455</b>	<b>PSD</b>	<b>002</b>	<b>SS06</b>	<b>SS06</b>	<b>ISHWARG</b>

