

Energy Management Control solution for Solar PV applications Type Eos-Box



- 100 to 240VAC power supply
- Dimensions(WxHxD): 225 x 225 x 45 mm
- Protection degree (front): IP20

- Fan-less embedded PC with Web-server capability
- Windows XP embedded operating system
- Managed information: V, A, kW, kWh, sun-irradiation, cell-temperature, air-temperature, wind speed on the DC part of the photovoltaic park and V, A, kW, kWh on the AC part and from both inverters and energy meters.
- Efficiency calculation and control on three different levels: string, BOS and total
- Variables shown as graphs and numbers in formatted tables
- Alarms control and automatic e-mailing and SMS management in case of GPRS modem external connection
- All data exports on XLS format
- Data storage up to 15 years in a 8GB DOM Memory
- Four RS485 communication ports (Modbus)
- One Ethernet port

Product description

Eos-Box is a fan-less embedded PC with Web-server capability suitable to gather photovoltaic plant information from Eos-Array, inverters, energy meters and interface protection. Eos-Box provides information in a quick and automatic fashion via the internet using a standard browser, so the data is avail-

able wherever you are. Eos-Box shows information such as: V, A, kW, kWh, sun-irradiation, cell-temperature, air-temperature, wind speed on the DC part of the photovoltaic park and V, A, kW, kWh on the AC part coming from both inverters and energy meters. All data are available as graphs and numbers in for-

How to order

Eos-Box D XX X

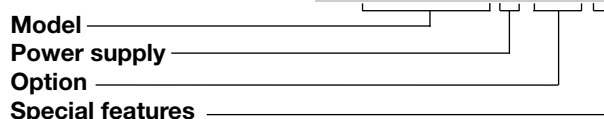

Type Selection

Power supply	Option	Special features	
D: from 100 to 240VAC (*)	XX: none (*)	X: none (*)	(*) as standard.

Hardware

Type Operating system Operation Processor Chipset	Embedded PC Windows XP embedded Fan-less AMD LX800 500 MHz AMD LX+CS5536+ITE8888G	Communication ports RS485	3 ports for Eos-Array bus management 1 port for Inverter, Interface protection and Energy meters
BIOS	Phoenix-Award 4Mbit with RPL/PXE LAN Boot ROM. SmartView and customer CMOS backup	Ethernet	1 for internet/LAN connection 1 for local access
Memory DDR DOM Back-up Industrial CompactFlash™	256MB SODIMM 8GB 8GB Type II (on request)	Other ports USB	3, for local access and service



Hardware (cont.)

LED Status and colour	Green for power-on Orange for DOM memory access	Ethernet USB	RJ-45 connector (10/100Base-T) High speed USB 2.0
Connections RS485	3 pole detachable screw terminal block per port		

RS485 communications ports

Type	Master function, Multidrop, bidirectional (static and dynamic variables)	Baud-rate	mark/space parity, 1/1.5/2 stop bit
Connections	2-wire. Max. distance 1000m	Driver input capability	Selectable: 9600, 19200, 38400, 115200 bits/s
Addresses	247	Insulation	1/5 unit load. Maximum 160 transceivers on the same bus.
Protocol	MODBUS/JBUS (RTU)		See the table "Insulation between inputs and outputs"
Data (bidirectional)	All variables		
Data format	Selectable: 1 start bit, 7/8 data bit, no/odd/even/		

Example of communication architecture

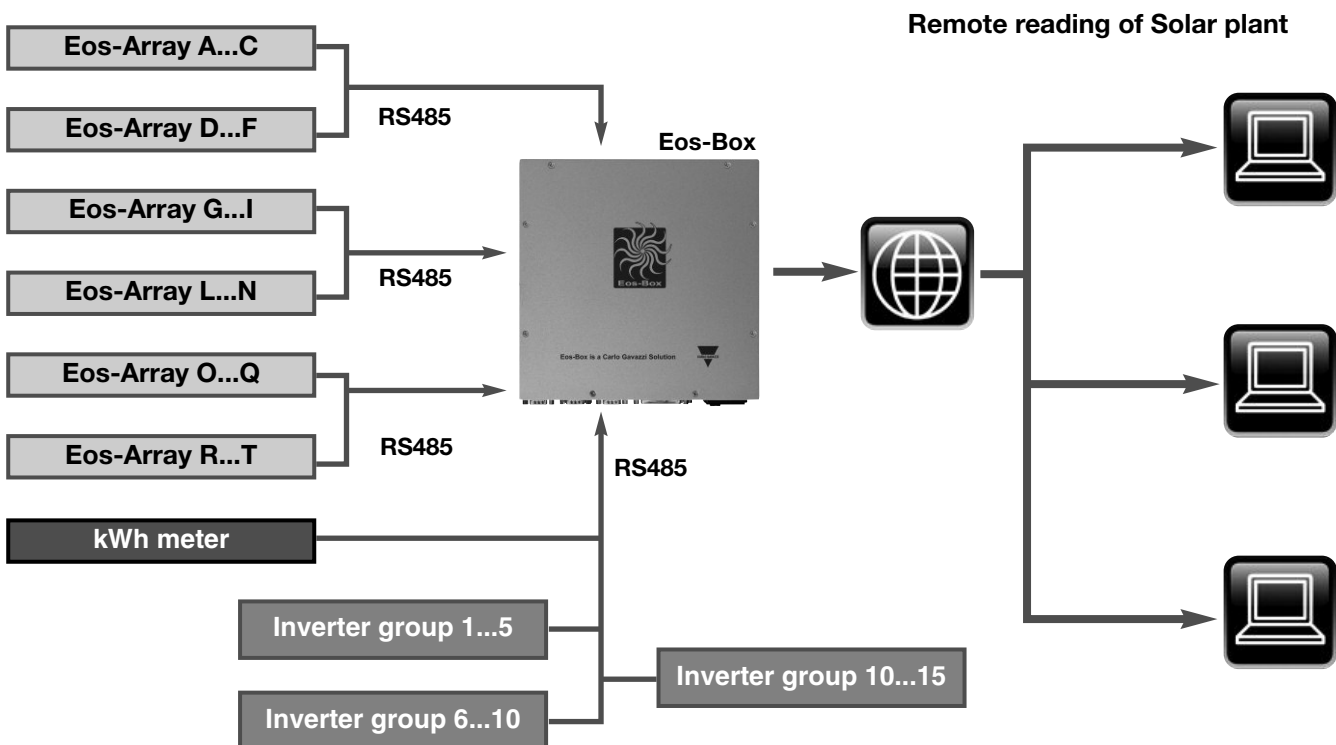

Eos-Box Management capability

Max. number of Eos-Array systems which can be managed by one Eos-Box						
Every Eos-Array is equipped with 15 VMU-S			Max. number of Eos-Array which can be connected to one port at the given communication speed			
Data logger time interval (minutes)	Total number of Eos-Array	Total number of VMU-S	@ 9600 bits/s	@ 19200 bits/s	@ 38400 bits/s	@ 115200 bits/s
1	18	270	13	18	18	18
5	84	1260	65	84	84	84
10	168	2520	130	168	168	168
15	247	3705	195	247	247	247
30	494	7410	247	247	247	247
60	741	11115	247	247	247	247
RS485 communication ports: 2-3-4						

- All the details of the daily logged data will be available and therefore displayable as graphs from 6 months (in case of 1 minute time interval) to 10 years (in case of 30 minutes time interval) for “Day” selection. The single day data will be available and displayable as graphs for 10 years (either “Month” or “Year” selection).
- 6 months and 10 years are worst conditions, they consider, according to the time interval, the maximum number of managed Eos-Array, if those latter ones decrease, the single data time availability will increase proportionally.

Max. number of Inverters and energy meters which can be managed by one Eos-Box		
Max. number of inverters	Maximum number of energy meters to be connected to one Eos-Box	
30	10 (with RS485 communication port)	1 (with pulse output and only from one VMU-M as kWh)
<ul style="list-style-type: none"> • All inverters have to be connected on "COM1". The refresh time of the data depends on the inverter's communication speed. • The data (power, energy, AC and DC) are stored with a time interval of 15 minutes. • Those data will be available for graph displaying for maximum 10 years. 	<p>RS485 communication port:</p> <ul style="list-style-type: none"> • The information acquired from every single energy meter is the metered active energy and where possible also the active power. The limit of number of connected energy meters is mainly due to the maximum number of inverters connected to the same port. • During the set-up of Eos-Box only one energy meter can be selected as main yield energy meter. • All the details of the daily logged data will be available and therefore displayable as graphs from 6 months (in case of 1 minute time interval) to 10 years (in case of 30 minutes time interval) “Day” selection. The single day data will be available and displayable as graphs for 10 years (either “Month” or “Year” selection). 	
Inverter, Energy meters and interface protection use the same RS485 communication port 1		

Max. number of sensors which can be managed by one Eos-Box	
Max. number of irradiation and wind speed sensors	Maximum number of temperature sensors
Depending on the number of VMU-P units available in the network	2 (VMU-M) + 2 (VMU-P)
<ul style="list-style-type: none"> • The irradiation and wind speed sensors can be as much as the number VMU-P units managed in the same network. • All the details of the daily logged data will be available and therefore displayable as graphs from 6 months (in case of 1 minute time interval) to 10 years (in case of 30 minutes time interval) “Day” selection. The single day data will be available and displayable as graphs for 10 years (either “Month” or “Year” selection). • Only one irradiation sensor within one Eos-Box has to be used as a reference for the efficiency calculation. 	<ul style="list-style-type: none"> • The temperature sensors can be as many as the number of VMU-P (being 2 channel inputs available per unit) + VMU-M (being 2 channel inputs available per unit). • All the details of the daily logged data will be available and therefore displayable as graphs from 6 months (in case of 1 minute time interval) to 10 years (in case of 30 minutes time interval) “Day” selection. The single day data will be available and displayable as graphs for 10 years (either “Month” or “Year” selection). • Only one air or cell temperature sensor within one Eos-Box has to be used as a reference for the efficiency calculation.

WEB-server displaying and control functionalities

Access page of Eos-Box

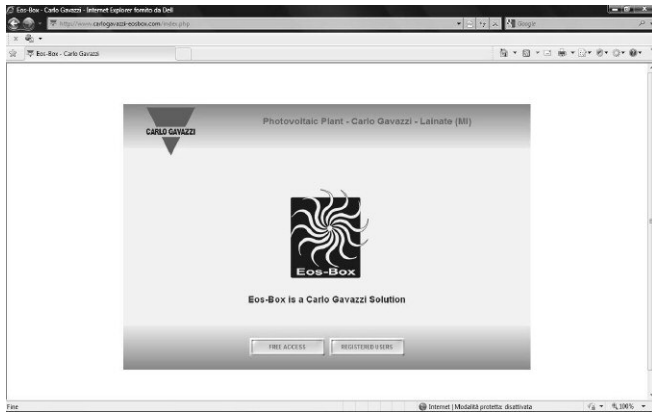

This page has a double access:

- “Free access”: there is access at one web page which has been formerly selected by the “Administrator”.
- “Registered users”: the access is with “User name” and “Password” and has different privileges according to the type of user:
 - As “User”: in this case the user has access to the “Home” page and all the other graphs and tables pages.
 - As an “Administrator”: in this case the user has access to all pages as per “User” above but in addition also to all “Settings” and to the “Account” management.

Home page

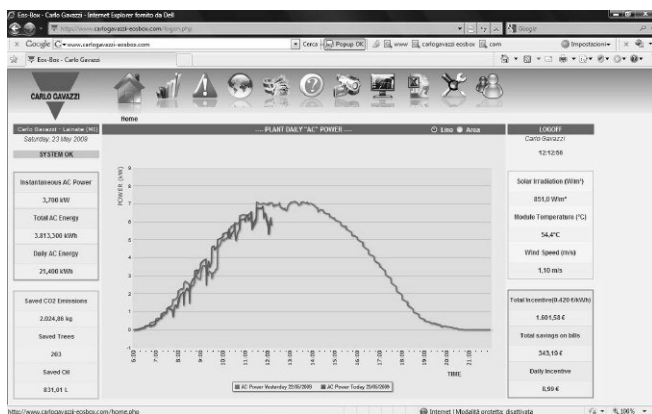

Fig. 1

The page is divided in four areas:

- 1 On the top. 11 icons are available to have direct access to different functionalities like (Fig.1):
 - Home page: Plant daily AC power;
 - Plant page: Detailed graphs and data table of all available variables;
 - Alarms page: alarms, warning, events, commands list;
 - Map page: alarms localisation on the photovoltaic park;
 - Economy page: economical parameters of the installation;
 - Information page: plant description with relevant technical data, financial highlights, energy production data source;
 - IP cam page: live images from the photovoltaic park;
 - Monitor page: combination of main graphs for accurate plant analysis;
 - Export page: data base export in Excel spreadsheet;
 - Setting page: access to the configuration of all parameters of Eos-Box;
 - Account page: access to LAN and Internet configuration.

- 2 On the middle (Fig.2). The plant daily power graph which allows to compare the actual AC power vs. the day before AC power. The graph is available as either a line or an area graph. The showed power may come directly either from the inverters or from the energy meters (selectable).

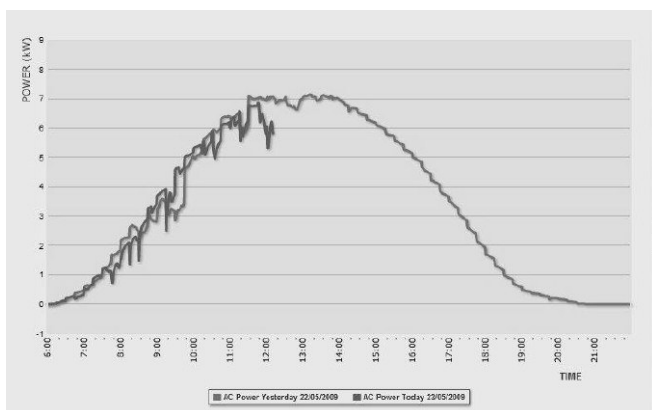

Fig. 2

WEB-server displaying and control functionalities (cont.)



Fig. 3

and

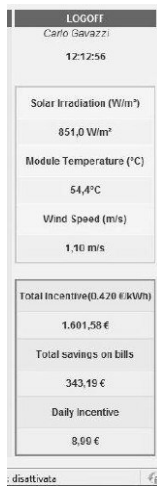

Fig 4

3 On the left hands (Fig.3). Power and Savings information such as:

- Instantaneous AC power (kW);
- Total AC energy (kWh);
- Daily AC energy (kWh);
- Saved CO2 emissions (kg);
- Saved trees (qty.);
- Saved oil (l/gallons).

4 On the right hands (Fig.4). Environment and Economic information such as:

- Solar irradiation (W/m², W/ft²);
- Module temperature (°C/°F);
- Wind speed (m/s, ft/s);
- Total incentive (currency/kWh);
- Total savings on bills (currency);
- Daily incentive (currency)

Plant pages

The page has access to 6 different and specialised menus like:

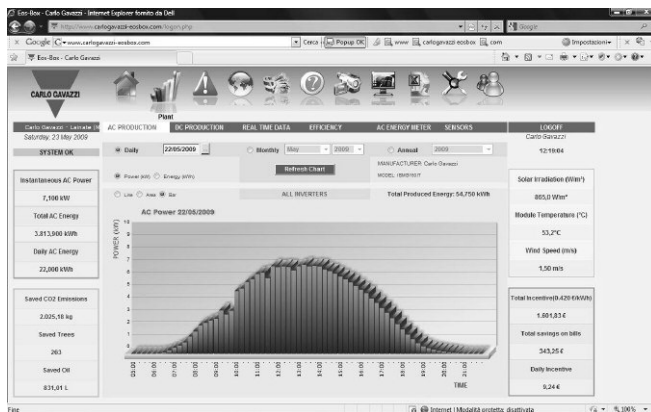

Fig. 5

1 AC production and then the following selections (Fig.5):

- All inverter, with the possibility to display AC kW, DC kW and AC kWh.
- Single inverters, with the possibility to display AC kW, DC, kW and AC kWh.

2 DC production and then the following selections (Fig.6):

- All strings, with the possibility to display DC kW, DC A and DC kWh.
- Single strings, with the possibility to display DC kW, DC A, DC V and DC kWh. The measurements are available either as single graphs where, by group, they appear all at the same time with different colours so to allow an easy comparison of the different strings or as a sum of kW, A and kWh. A specific tool (see fig.7) allows to select the requested string for proper analysis.



Fig. 6

3 Real time data and then the following selections (Fig.8):

- Inverter: a table with one line per inverter with the following information will appear: inverter name (label), V AC, A AC, kW AC, V DC, A DC, kW DC, AC kWh from energy meter and the inverter status.
- Eos-Array: a table with one line per string (VMU-S) with the following information will appear: VMU-S position (label), V DC, A DC, kW DC and VMU-S status. A specific tool (see fig.7) allows to select the requested string for proper analysis.
- AC energy meter: a table with one line per energy meter with the following information will appear: Name, Type (label), AC kW, AC kWh.

WEB-server displaying and control functionalities (cont.)



Fig. 7



Fig. 8

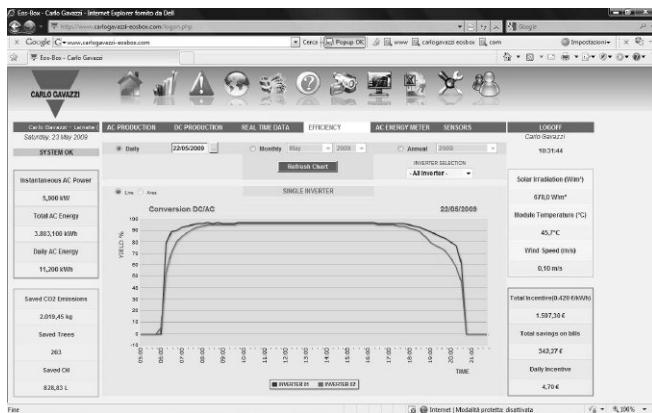

Fig. 9



Fig. 10

4 Efficiency and then the following selections (Fig.9):

- Total: this graph shows the efficiency of the whole photovoltaic park under control (DC and AC part);
- Eos-Array: these combinations of graphs show the efficiencies of the DC part of the installation. The selection can be either “All strings” or “Single strings” and allows to analyse in case of “Total String” selection the behaviour of the efficiency of all strings together. In case of “Single string” selection a group of single strings will be shown with its own efficiency. This graph will allow the user to analyse the behaviour of the photovoltaic park. A specific tool (see fig.7) allows to select the requested string for proper analysis.
- Inverter: these combinations of graphs show the efficiencies of the DC to AC conversion inside the inverters. The selection can be either “All inverters” or “Single inverters” and allows to analyse in case of “Total inverters” selection the behaviour of the efficiency of all inverters together. In case of “Single inverter” selection a group of single inverter will be shown with its own efficiency. It is possible to select with a proper tool all the inverters in the network.
- BOS: this graph shows the efficiency of the AC part photovoltaic park under control.

5 AC energy meter and then the following selections (Fig.10):

- Main: the graph shows the total AC energy production to grid.
- Partial: the graph shows the partial (when the photovoltaic park is split in several parts) AC energy production to grid.

6 Sensors and then the following selections (Fig.11):

- Solar irradiation: the graph shows the solar irradiation which also used to calculate the string efficiency.
- Temperature: there is the possibility to select and to show many different graphs of temperature depending on the VMU-M and VMU-P settings, example: cell temperature, air temperature, string box temperature and so on.
- Wind speed: the graph shows the wind speed.

WEB-server displaying and control functionalities (cont.)



Fig. 11

Every single page has the possibility to show, according to the kind of variable, the graphs in three different ways: line, area, bar. The user has access to the database based on daily graph, with 24 hours time interval. The needed day is selectable by means of a calendar functionality. The same database can be displayed as “Month” (31 days) with “Month” and “Year” selection or “Year” graph (12 months) with “Year” selection.

Alarms page



Fig. 12

The page has access to the list of all available anomalies not yet disappeared and not yet acknowledged such as:

- Alarms: alarms set by the user as high priority types;
- Warning: alarms set by the user as low priority types;
- Events: any kind of event recorded by Eos-Array;
- Commands: closing/opening contact detected by Eos-Array.

The page is split in two main parts which are then sub-split in some columns:

- Device type, Label, Alarm type, Start date, Start time, End date, End time: these information are all details relevant to the recorded alarm. Every line is a new alarm.
- Address, Group (VMU-M), Position, Channel: these are the information of the same line above but relevant to the device which has generated the alarm.
- All alarms according the privilege of the user can be hidden.



Fig. 13

One box (Fig.13) on the left hands upper corner shows at a glance the status of the photovoltaic park. Two type of messages may appear:

- STATUS OK (green): there are no alarms or low priority alarms;
- ALARM with message (red): there are high priority alarms.

WEB-server displaying and control functionalities (cont.)

Map page

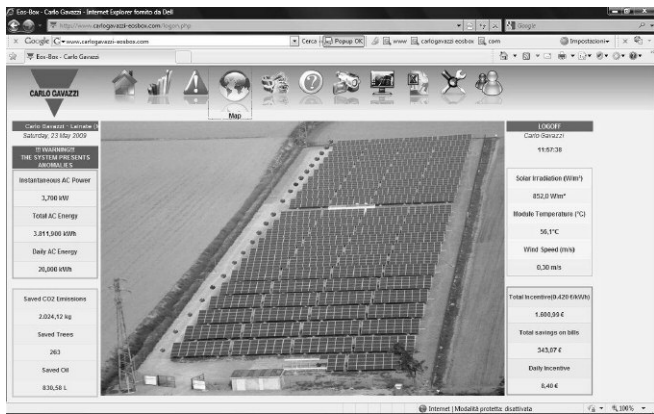

Fig. 14

This page shows, based on a map picture (JPG) loaded by the user the status of alarms on the photovoltaic park. The status is shown with:

Green LED: no anomalies;

Red LED: high priority alarms detected by the local Eos-Array systems.

Clicking with the mouse on the LED there is a direct access on the string managed by Eos-Array. If the LED is red the access is to Alarm list page (Fig.12), if the LED is green the access is to the relevant String (VMU-S) graph.

Economy page

This page shows to the user :

- the ROI (Return of Investment) status, current vs. expected;
- the delay in “days” of the investment payback;
- the total invested capital and the capital interests;
- the daily capital earnings;
- the total capital earnings;
- the feed-in tariff parameters.

Information page



Fig. 15

This page shows to the user:

- the plant description such as: plant name, plant location, plant property, installer, PV module installation date and Eos-Box installation date;
- the technical data such as: plant type, total area of PV modules, number of inverters, number of strings, peak power of plant;
- the financial highlights such as: energy system, incentive paid per kWh, kWh purchasing price, % of sold energy vs. total produced energy, price per sold kWh;
- the energy production data source: inverter or energy meter which has been selected in settings.

IP cam page

This page shows to the user live images of the photovoltaic park. There are two possible selections:

- “Select IP cam” where the user can chose to which IP cam to connect and upload the image;
- “Mosaic” where the user can see four IP cams simultaneously.

Eos-Box is capable to manage any kind of IP cam, it is independent from the type, as long as it is an IP type. Also DVR IP cams can be managed and those with remote position control.

WEB-server displaying and control functionalities (cont.)

Monitor page



Fig. 16

This page shows to the user:

Three combinations of variables which will let the user to understand how the photovoltaic park behaves and if there are problems such low efficiencies.

- DC Power as a combination of 4 graphs: all strings efficiency, DC power, Solar irradiation, Cell or air temperature (depending on the selection made by the user). The time interval of the graphs is depending on settings of Eos-Array system;
- AC Power as a combination of 4 graphs: Total efficiency, AC power (three sources are selectable: inverter, energy meter, inverter + energy meter), Solar irradiation, Cell or air temperature (depending on the selection made by the user). The time interval of the graphs is 30 minutes;
- Efficiency as a combination of 3 graphs: all strings efficiency, BOS efficiency and Total efficiency.

Export page

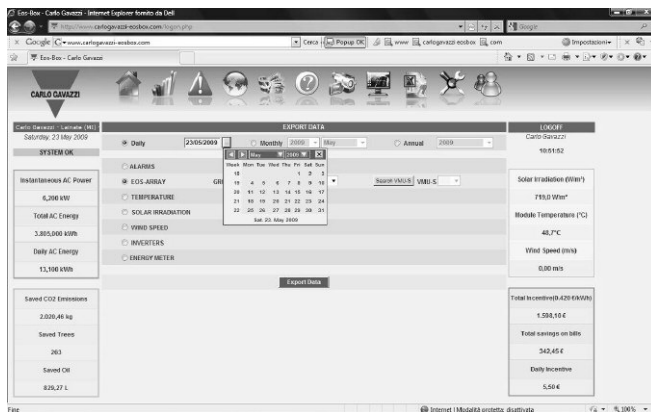

Fig. 17

The database of the whole photovoltaic park managed by the Eos-Box can be downloaded as an Excel spreadsheet and is available according to the following selection:

- Daily: 24 hours time interval with the selection of the needed "Day" using a calendar tool;
- Monthly: max. 31 days with the selection of the needed "Month" and "Year";
- Annual: 12 months with the selection of the needed "Year".

In order to help the user to focus on the desired information a further criteria is available:

- Alarms
- Eos-Array
- Temperature
- Solar irradiation
- Wind speed
- Inverters
- Energy meter



Configuration

Setting page

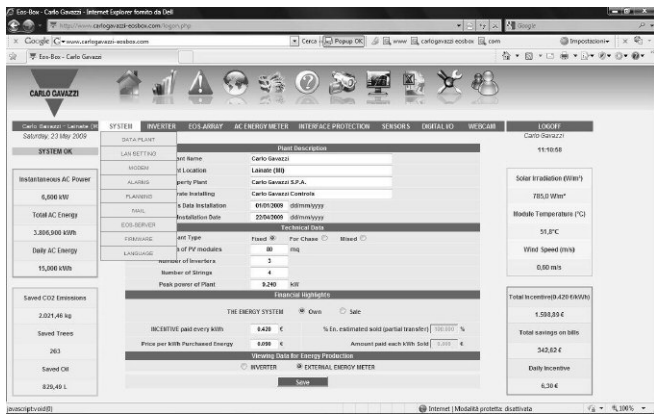

Fig. 18

This main configuration menu allows the user to access to all parameters relevant to the Eos-Box such as:

- System: all main parameters of Eos-Box;
- Inverter: all communication parameters of the connected inverters;
- Eos-Array: all communication parameters of the connected Eos-Arrays;
- AC energy meter: all communication parameters of the connected energy meters;
- Interface protection: all communication parameters of the connected interface protection device;
- Sensors: all information of the used sensors;
- Digital I/O: all information of the used I/Os;
- IP cam: all communication parameters of the connected IP cams.

Most of the listed settings are provided with sub-menus as explained in the next figures.

System



Fig. 19

This first menu allows the user to configure the following sub-menus:

- Data plant: the setting of all parameters as already explained at the figure 15 above.
- LAN setting: the Eos-Box label and the Network settings like: automatic IP address (DHCP) or manual: IP address, subnet mask, default gateway; automatic DNS server address or manual DNS server address (preferred and alternative DNS server).
- Modem (Fig.19 and Fig.20): this sub-menu allows not only to configure the connected wireless modem but also to check if it works. The following parameters can be set: No modem; GPRS/EDGE/UMTS/HSDPA modem with internet connection and/or SMS; IP router based GPRS/EDGE/UMTS/HSDPA with internet connection and/or SMS, and IP router address; configuration of Internet connection selecting also the provider.
- Alarms: this sub-menu is used to configure the management of all alarms, the labels to be displayed at the figure 12 and the link of variable versus type of anomaly: high priority alarm (alarm), low priority alarm (warning), events and commands.
- Planning: this-sub-menu is used to enable the automatic e-mailing based on daily, weekly and monthly shipments with pre-set time, the list of the e-mail addresses and the relevant attachments. The enabling of alarms, the setting of the relevant messages and attachments.
- Mail: this sub-menu allows to configure the classical e-mail parameters to manage the communication.
- Eos-Server: this sub menu is used to configure the communication to an Eos-Server which is a machine capable to gather data from several Eos-Boxes also in different locations so to work out a global service.
- Firmware: this particular sub-menu allows the service people to upgrade the firmware running into the Eos-Box.

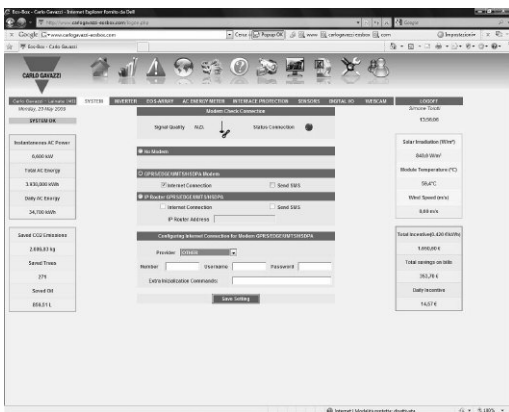

Fig. 20

Configuration (cont.)

Inverter

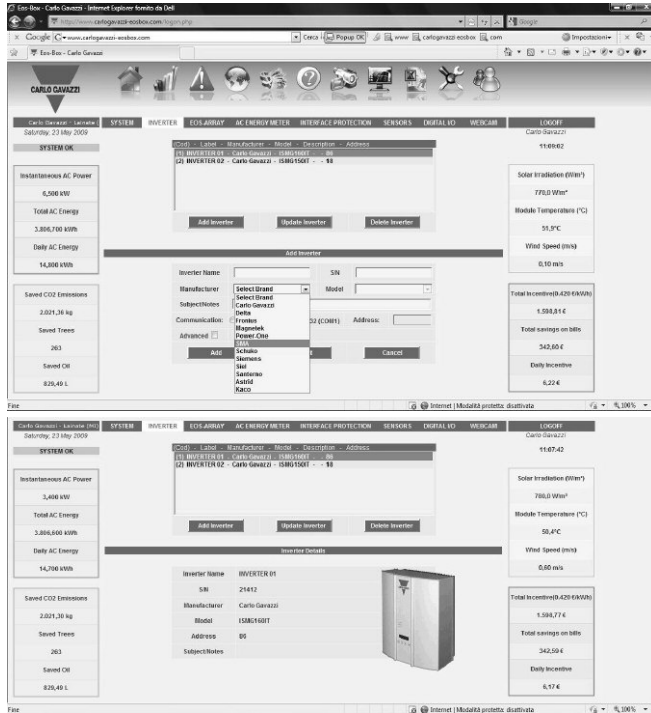

Fig. 21 and Fig. 22

This sub-menu allows the user to:

- “Add” a new inverter to the network managed by Eos-Box;
- “Update” the parameters of an existing inverter;
- “Delete” an already configured inverter.

The main parameters which can be configured are:

- Inverter name as a label;
- Serial number of the inverter being connected;
- Manufacturer, selectable among the following brands: Carlo Gavazzi, Delta, Fronius, Magnetek, Power-one, SMA, Schuko, Siemens, Siel, Elettronica Santerno, Astrid, Kaco. Other brands will be added in the future.
- Model shown in accordance to the selected manufacturer. Other models will be added in the future.
- Subject/notes: a text which can be typed in by the user;
- Communication type: RS485 (COM1) or RS232 (COM1) and relevant address;
- Some advanced communication functionalities like: baud rate, data bit number, parity, stop bit number.

Eos-Array

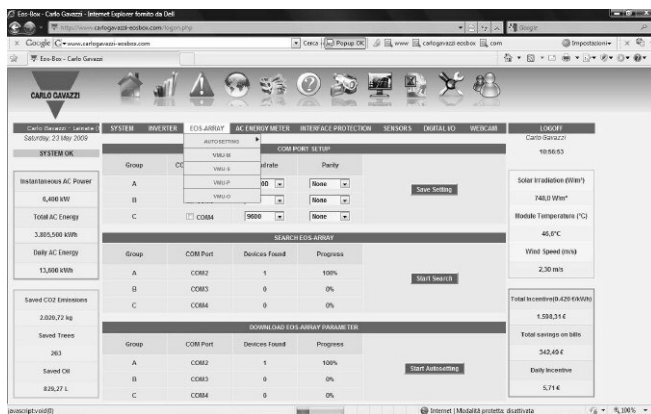

Fig. 23

This sub-menu is split in several other menus such as:

- Auto-setting, Set-up and Update, see details below;
- VMU-M: it is possible to label the device and read all configured parameters;
- VMU-S: it is possible to label the device and also to link it to the relevant inverter, moreover the page shows all the VMU-S configured parameters;
- VMU-P it is possible to label the device and read all configured parameters;
- VMU-O it is possible to label the device and read all configured parameters;

For security reasons the Eos-Array parameters can be set only locally and by using its configuration software Eos-ArraySoft. The only parameters which can be changed from Eos-Box are the alarm set-points, which can be adjusted for installation fine tuning.

Auto-setting: the “Set-up” menu allows the user to configure all the communication parameters of Eos-Arrays being connected to the network. The page is split in three parts:

- “Communication port setup” where it is possible to select for each group A-B-C (corresponding to each communication port) the communication port enable, the baud rate and the parity. This represents the first step.
- “Search Eos-Array” where it is possible to start the relevant search, this is the second step.
- “Download Eos-Array parameters” as auto-setting start.

Configuration (cont.)

AC Energy Meter

As for the inverters also here it is possible to “Add”, “Update” and “Delete a device which is in this case an energy meter.

The main parameters which can be configured are:

- Meter name as a label;
- Serial number of the meter being connected;
- Manufacturer, selectable among the following brands: Carlo Gavazzi, others. Other brands will be added in the future.
- Model shown in accordance to the selected manufacturer. Other models will be added in the future.
- Subject/notes: a text which can be typed in by the user;
- Meter reference for BOS and Total efficiency calculation;
- Communication type: RS485 (COM1) and relevant address or pulses coming from VMU-M;
- Energy metering as exported or imported energy;
- Energy offset;
- Some advanced communication functionalities like: baud rate, data bit number, parity, stop bit number.

Interface protection

This sub-menu allows to configure:

- Device name as a label;
- Serial number of the device being connected;
- Manufacturer, selectable among the following brands: Carlo Gavazzi, others. Other brands will be added in the future.
- Model shown in accordance to the selected manufacturer. Other models will be added in the future.
- Subject/notes: a text which can be typed in by the user;
- Communication type: RS485 (COM1) and relevant address.

Sensors

This sub-menu allows to configure the type of sensor in the Eos-Array system such as:

- Solar irradiation;
- Temperature;
- Wind speed.

For every single sensor it is possible to configure the following parameters:

- Device name as a label;
- Sensor state: enabled/disabled;
- Reference device for efficiency calculation.

Digital I/O

This sub-menu allows to configure the “Name” as a label of every single device in the Eos-Array system.

IP cam

This sub-menu allows to configure the

- “Name” as a label of every single IP cam in the network;
- Management parameters of the IP cam;
- Network settings like: automatic IP address (DHCP) or manual: IP address, subnet mask, default gateway; automatic DNS server address or manual DNS server address (preferred and alternative DNS server).

Insulation between inputs and outputs

Type of input/output	Ac Power supply	RS485 port 1 (Inverter, energy meters and interface protection)	RS485 port 2 (Eos-Array)	RS485 port 3 (Eos-Array)	RS485 port 4 (Eos-Array)	Ethernet port 1 (LAN/Internet)	Ethernet port 2 (Service)	USB ports (Service)
Ac Power supply	-	4kV	4kV	4kV	4kV	4kV	4kV	4kV
RS485 port 1 (Inverter, energy meters and interface protection)	4kV	-	0kV	0kV	0kV	4kV	4kV	4kV
RS485 port 2 (Eos-Array)	4kV	0kV	-	0kV	0kV	4kV	4kV	4kV
RS485 port 3 (Eos-Array)	4kV	0kV	0kV	-	0kV	4kV	4kV	4kV
RS485 port 4 (Eos-Array)	4kV	0kV	0kV	0kV	-	4kV	4kV	4kV
Ethernet port 1 (LAN/Internet)	4kV	4kV	4kV	4kV	4kV	-	4kV	4kV
Ethernet port 2 (Service)	4kV	4kV	4kV	4kV	4kV	4kV	-	4kV
USB ports (Service)	4kV	4kV	4kV	4kV	4kV	4kV	4kV	-

0kV	Inputs / outputs are not insulated.
4kVrms	EN61010-1, IEC60664-1 - Over-voltage category III, Pollution degree 2, double insulation on systems with max. 300Vrms to ground

General specifications

Operating temperature	-20 to +50°C (-4°F to 122°F) (R.H. from 0 to <90% non-condensing @ 40°C) See also "VMU-S input specifications"	PI-Q Failure rate	1.0 (Quality Level II) 12 567.29 FITs (Failure In Time)
Storage temperature	-20 to +80°C (-4°F to 176°F) (R.H. < 90% non-condensing @ 40°C)	Environment condition 1	Grounded, fixed, uncontrolled GF (PI-E = 2.0) 60°C 79 571 hours (Mean Time Between Failures)
Approvals	CE	Test temperature MTBF @ PI-E = 2.0	Grounded, fixed, controlled GB (PI-E = 1.0) 40°C 195 710 hours (Mean Time Between Failures)
Housing Dimensions (WxHxD) Material	225 x 225 x 45 mm Aluminium and Heavy-duty steel	Environment condition 2	
Mounting	Wall and DIN-rail with additional bracket	Test temperature MTBF @ PI-E = 1.0	
Vibration endurance	2G RMS W/CF 5-500Hz, X-Y-Z direction	Protection degree	
Failure tests Electrical stress condition	50%	Front Screw terminals Weight	IP20 IP20 2.15Kg

Power supply specifications

Power supply

100 to 240VAC

Power consumption

70W

Overall dimensions

