

CMPA3135060S

3.1 - 3.5 GHz, 60 W, Packaged GaN MMIC Power Amplifier

Description

Cree's CMPA3135060S is a gallium nitride (GaN) High Electron Mobility Transistor (HEMT) based monolithic microwave integrated circuit (MMIC). GaN has superior properties compared to silicon or gallium arsenide, including higher breakdown voltage, higher saturated electron drift velocity and higher thermal conductivity. This MMIC power amplifier contains a two-stage reactively matched amplifier design approach, enabling high power and power added efficiency to be achieved in a 7mm x 7mm, surface mount (QFN package). The MMIC is designed for S-Band radar power amplifier applications.

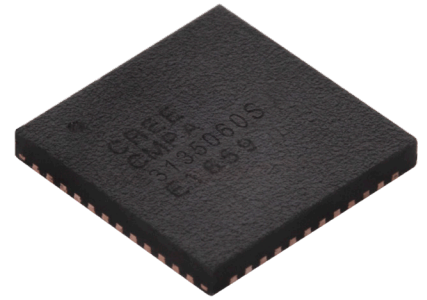

PN: CMPA3135060S
Package Type: 7 x 7 QFN

Typical Performance Over 3.1 - 3.5 GHz ($T_c = 25^\circ\text{C}$)

Parameter	3.1 GHz	3.3 GHz	3.5 GHz	Units
Small Signal Gain ^{1,2}	37	37	36	dB
Output Power ^{1,3}	72	83	87	W
Power Gain ^{1,3}	29	29	29	dB
Power Added Efficiency ^{1,3}	55	55	57	%

Notes:

¹ $V_{DD} = 50\text{ V}$, $I_{DQ} = 260\text{ mA}$

²Measured at $P_{in} = -20\text{ dBm}$

³Measured at $P_{in} = 20\text{ dBm}$ and $300\text{ }\mu\text{s}$; Duty Cycle = 20%

Features

- 3.1 - 3.5 GHz Operation
- 75 W Typical Output Power
- 29 dB Power Gain
- 50-ohm Matched for Ease of Use
- Plastic Surface-Mount Package, 7x7 mm QFN

Note: Features are typical performance across frequency under 25°C operation. Please reference performance charts for additional details.

Applications

- Air Traffic Control Radar
- Defense Surveillance Radar
- Fire Control Radar
- Military Air, Land and Sea Radar
- Weather Radar

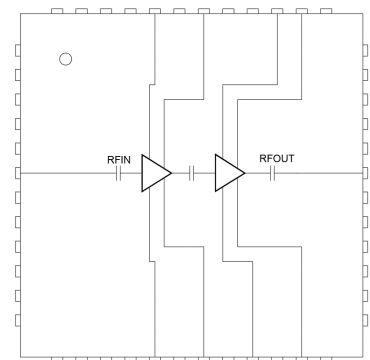

Figure 1.



Absolute Maximum Ratings (not simultaneous) at 25 °C

Parameter	Symbol	Rating	Units	Conditions
Drain-source Voltage	V_{DSS}	150	VDC	25°C
Gate-source Voltage	V_{GS}	-10, +2	VDC	25°C
Storage Temperature	T_{STG}	-55, +150	°C	
Maximum Forward Gate Current	I_G	15.2	mA	25°C
Maximum Drain Current	I_{DMAX}	14.2	A	
Soldering Temperature	T_S	260	°C	

Electrical Characteristics (Frequency = 3.1 GHz to 3.5 GHz unless otherwise stated; $T_c = 25^\circ\text{C}$)

Characteristics	Symbol	Min.	Typ.	Max.	Units	Conditions
DC Characteristics						
Gate Threshold Voltage	$V_{GS(TH)}$	-3.8	-3.0	-2.3	V	$V_{DS} = 10\text{ V}, I_D = 15.2\text{ mA}$
Gate Quiescent Voltage	$V_{GS(Q)}$	-	-2.7	-	V_{DC}	$V_{DD} = 50\text{ V}, I_{DQ} = 260\text{ mA}$
Saturated Drain Current ¹	I_{DS}	9.9	14.1	-	A	$V_{DS} = 6.0\text{ V}, V_{GS} = 2.0\text{ V}$
Drain-Source Breakdown Voltage	V_{BD}	100	-	-	V	$V_{GS} = -8\text{ V}, I_D = 15.2\text{ mA}$
RF Characteristics^{2,3}						
Small Signal Gain	S_{21_1}	-	36	-	dB	Pin = -20 dBm, Freq = 3.1 - 3.5 GHz
Output Power	P_{OUT1}	-	72	-	W	$V_{DD} = 50\text{ V}, I_{DQ} = 260\text{ mA}, P_{IN} = 20\text{ dBm}, \text{Freq} = 3.1\text{ GHz}$
Output Power	P_{OUT2}	-	83	-	W	$V_{DD} = 50\text{ V}, I_{DQ} = 260\text{ mA}, P_{IN} = 20\text{ dBm}, \text{Freq} = 3.3\text{ GHz}$
Output Power	P_{OUT3}	-	87	-	W	$V_{DD} = 50\text{ V}, I_{DQ} = 260\text{ mA}, P_{IN} = 20\text{ dBm}, \text{Freq} = 3.5\text{ GHz}$
Power Added Efficiency	PAE_1	-	55	-	%	$V_{DD} = 50\text{ V}, I_{DQ} = 260\text{ mA}, P_{IN} = 20\text{ dBm}, \text{Freq} = 3.1\text{ GHz}$
Power Added Efficiency	PAE_2	-	55	-	%	$V_{DD} = 50\text{ V}, I_{DQ} = 260\text{ mA}, P_{IN} = 20\text{ dBm}, \text{Freq} = 3.3\text{ GHz}$
Power Added Efficiency	PAE_3	-	57	-	%	$V_{DD} = 50\text{ V}, I_{DQ} = 260\text{ mA}, P_{IN} = 20\text{ dBm}, \text{Freq} = 3.5\text{ GHz}$
Power Gain	G_{P1}	-	29	-	dB	$V_{DD} = 50\text{ V}, I_{DQ} = 260\text{ mA}, P_{IN} = 20\text{ dBm}, \text{Freq} = 3.1\text{ GHz}$
Power Gain	G_{P2}	-	29	-	dB	$V_{DD} = 50\text{ V}, I_{DQ} = 260\text{ mA}, P_{IN} = 20\text{ dBm}, \text{Freq} = 3.3\text{ GHz}$
Power Gain	G_{P3}	-	29	-	dB	$V_{DD} = 50\text{ V}, I_{DQ} = 260\text{ mA}, P_{IN} = 20\text{ dBm}, \text{Freq} = 3.5\text{ GHz}$
Input Return Loss	S_{11}	-	-12	-	dB	Pin = -20 dBm, Freq = 3.1 - 3.5 GHz
Output Return Loss	S_{22}	-	-7	-	dB	Pin = -20 dBm, Freq = 3.1 - 3.5 GHz
Output Mismatch Stress	VSWR	-	-	5 : 1	Ψ	No damage at all phase angles

Notes:

¹ Scaled from PCM data² Measured in CMPA3135060S high volume test fixture at 3.1, 3.3 and 3.5 GHz and may not show the full capability of the device due to source inductance and thermal performance.³ Unless otherwise noted: Pulse Width = 25 μs , Duty Cycle = 1%**Thermal Characteristics**

Parameter	Symbol	Rating	Units	Conditions
Operating Junction Temperature	T_J	225	°C	
Thermal Resistance, Junction to Case (packaged) ¹	$R_{\theta JC}$	TBD	°C/W	Pulse Width = 300 μs , Duty Cycle = 20%

Notes:

¹ Measured for the CMPA3135060S at $P_{DISS} = \text{TBD W}$



Typical Performance of the CMPA3135060S

Test conditions unless otherwise noted: $V_D = 50\text{ V}$, $I_{DQ} = 260\text{ mA}$, Pulse Width = $300\ \mu\text{s}$, Duty Cycle = 20%, $P_{in} = 20\text{ dBm}$, $T_{BASE} = +25\text{ }^\circ\text{C}$

Figure 1. Output Power vs Frequency as a Function of Temperature

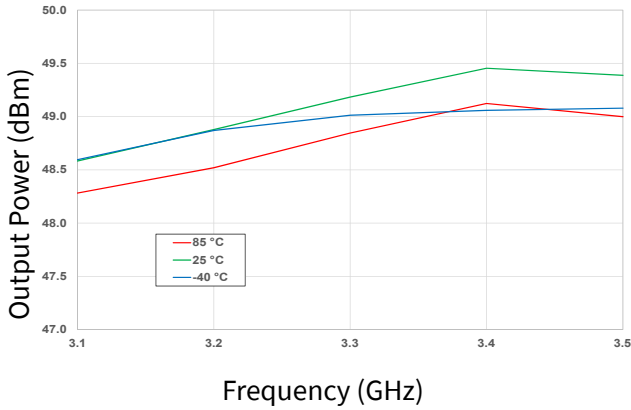

Figure 2. Output Power vs Frequency as a Function of Input Power

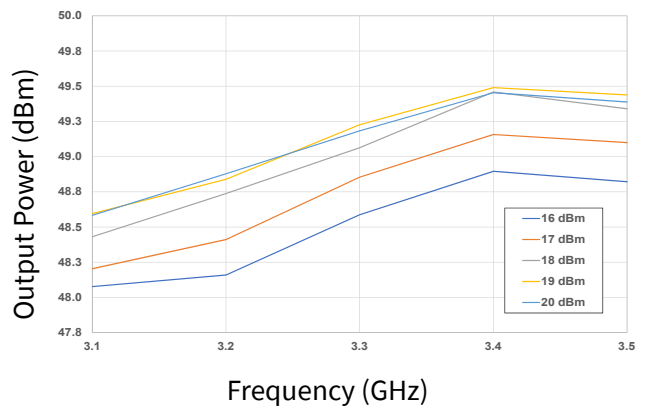

Figure 3. Power Added Eff. vs Frequency as a Function of Temperature

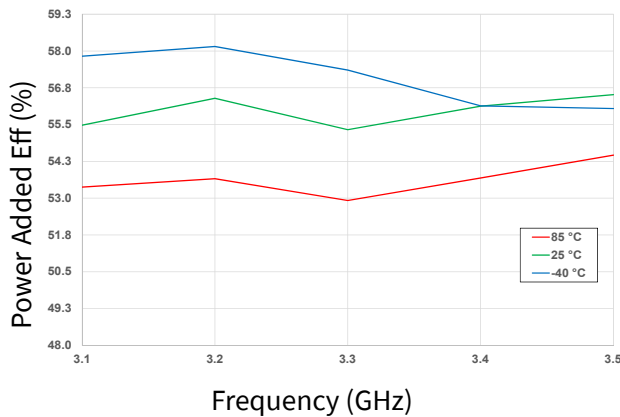

Figure 4. Power Added Eff. vs Frequency as a Function of Input Power

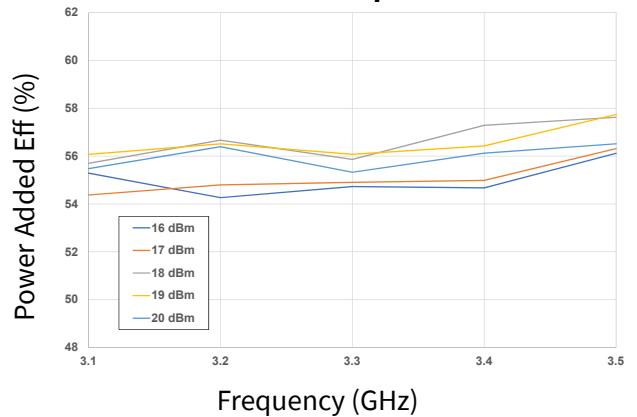

Figure 5. Drain Current vs Frequency as a Function of Temperature

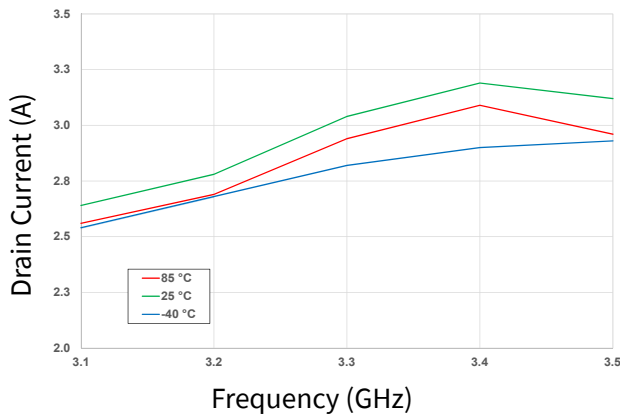
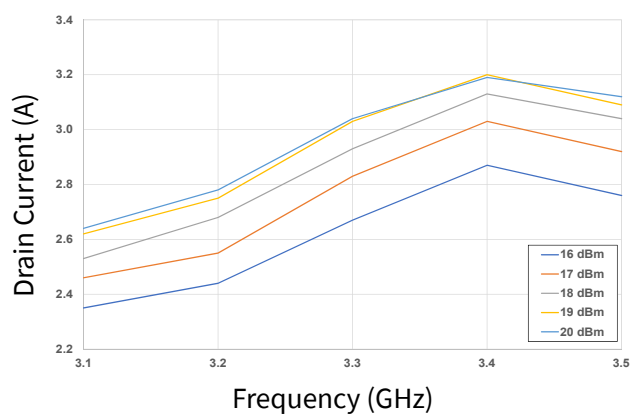

Figure 6. Drain Current vs Frequency as a Function of Input Power





Typical Performance of the CMPA3135060S

Test conditions unless otherwise noted: $V_D = 50\text{ V}$, $I_{DQ} = 260\text{ mA}$, Pulse Width = $300\text{ }\mu\text{s}$, Duty Cycle = 20%, Pin = 20 dBm, $T_{BASE} = +25\text{ }^\circ\text{C}$

Figure 7. Output Power vs Frequency as a Function of VD

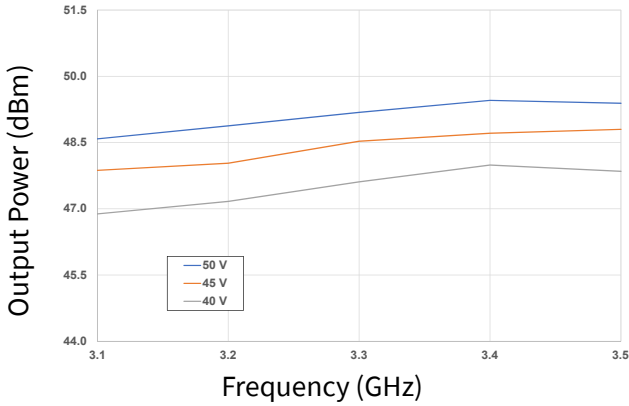

Figure 8. Output Power vs Frequency as a Function of IDQ

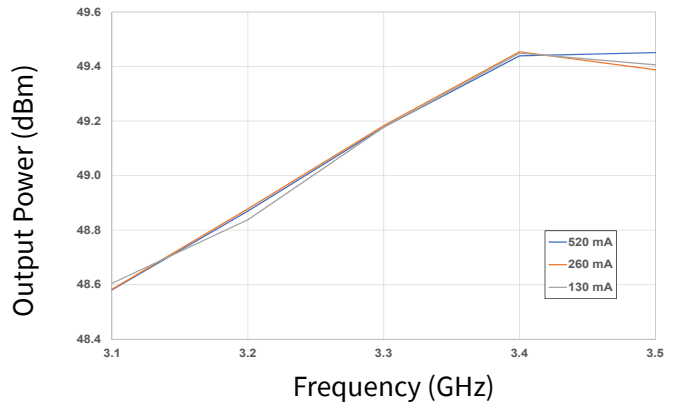

Figure 9. Power Added Eff. vs Frequency as a Function of VD

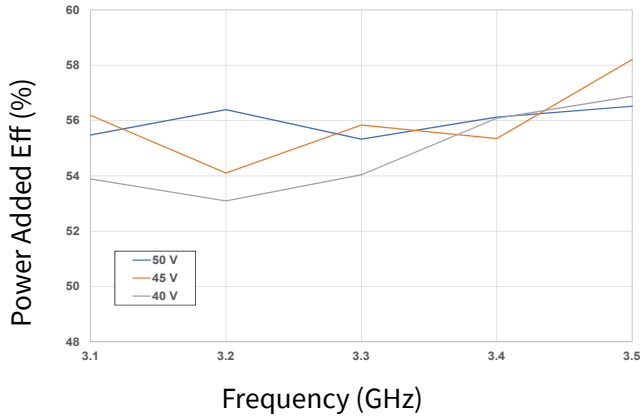

Figure 10. Power Added Eff. vs Frequency as a Function of IDQ

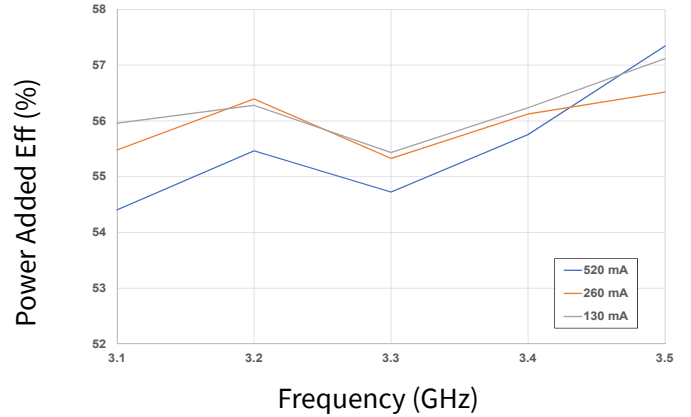

Figure 11. Drain Current vs Frequency as a Function of VD

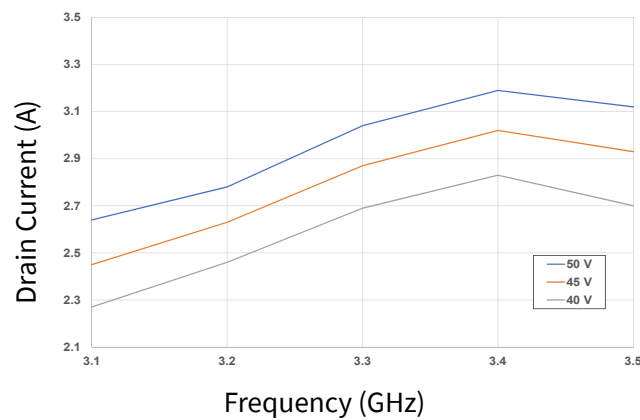
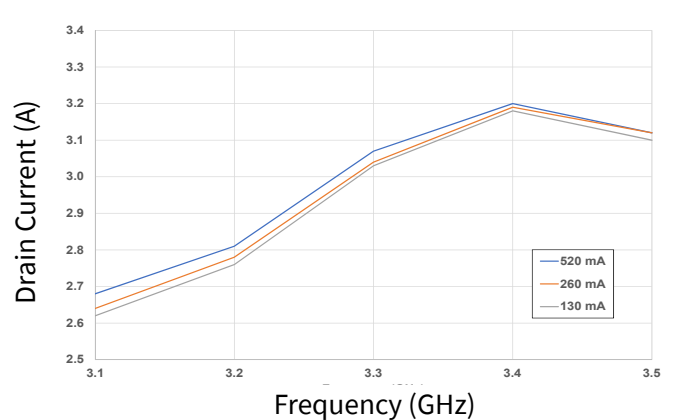

Figure 12. Drain Current vs Frequency as a Function of IDQ





Typical Performance of the CMPA3135060S

Test conditions unless otherwise noted: $V_D = 50\text{ V}$, $I_{DQ} = 260\text{ mA}$, Pulse Width = $300\ \mu\text{s}$, Duty Cycle = 20%, $P_{in} = 20\text{ dBm}$, $T_{BASE} = +25\text{ }^\circ\text{C}$

Figure 13. Output Power vs Input Power as a Function of Frequency

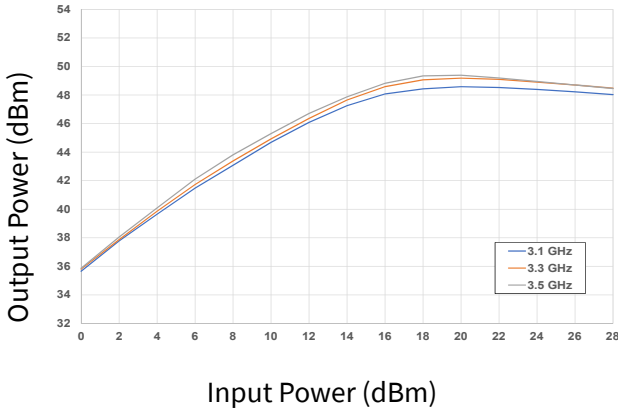

Figure 14. Power Added Eff. vs Input Power as a Function of Frequency

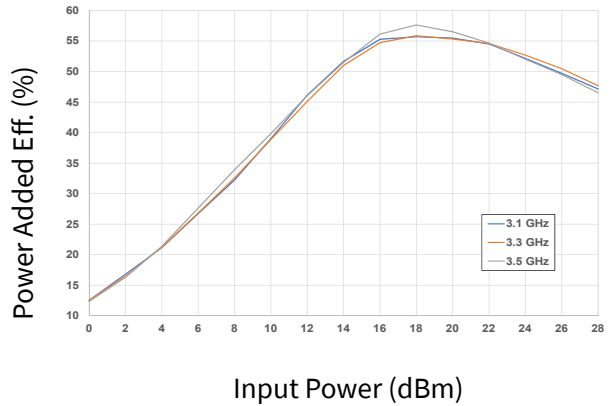

Figure 15. Large Signal Gain vs Input Power as a Function of Frequency

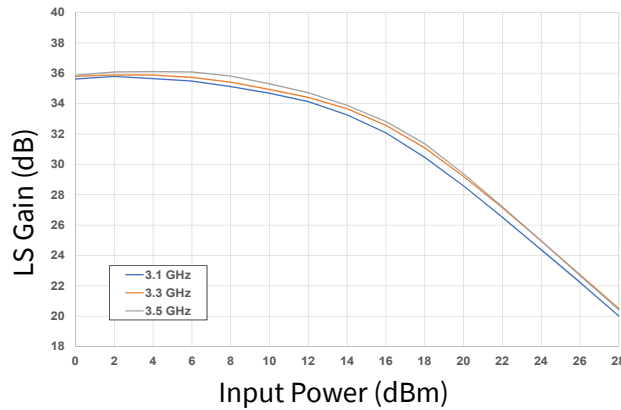

Figure 16. Drain Current vs Input Power as a Function of Frequency

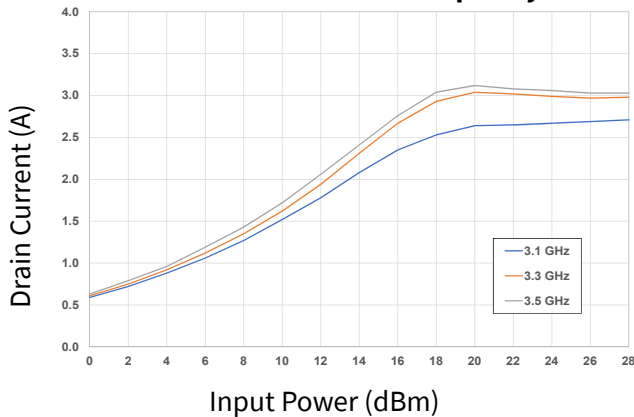
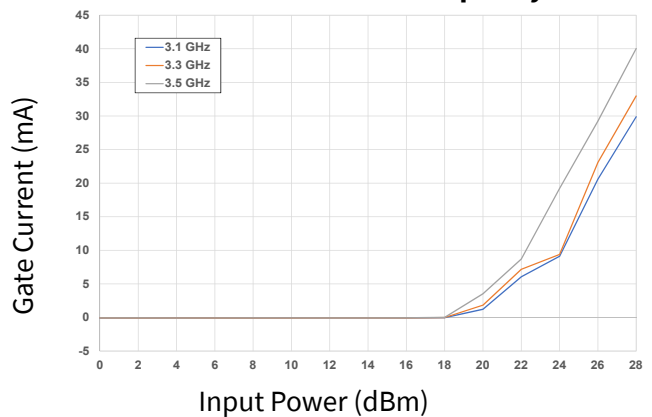

Figure 17. Gate Current vs Input Power as a Function of Frequency





Typical Performance of the CMPA3135060S

Test conditions unless otherwise noted: $V_D = 50\text{ V}$, $I_{DQ} = 260\text{ mA}$, Pulse Width = $300\ \mu\text{s}$, Duty Cycle = 20%, Pin = 20 dBm, $T_{BASE} = +25\text{ }^\circ\text{C}$

Figure 18. Output Power vs Input Power as a Function of Temperature

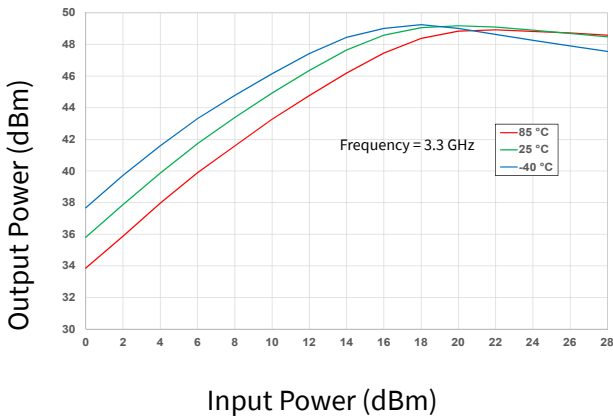

Figure 19. Power Added Eff. vs Input Power as a Function of Temperature

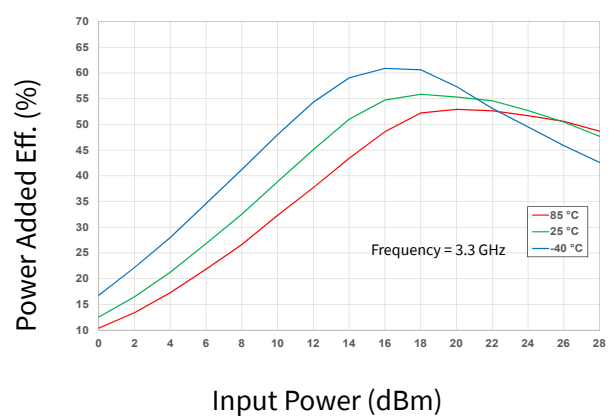

Figure 20. Large Signal Gain vs Input Power as a Function of Temperature

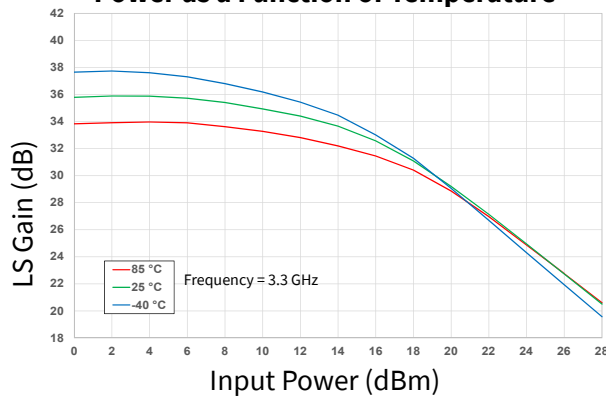

Figure 21. Drain Current vs Input Power as a Function of Temperature

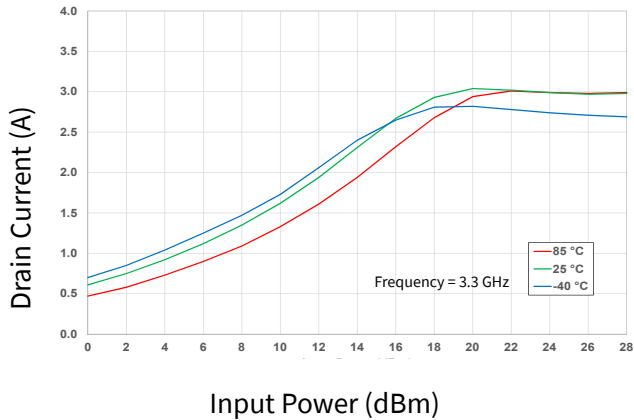
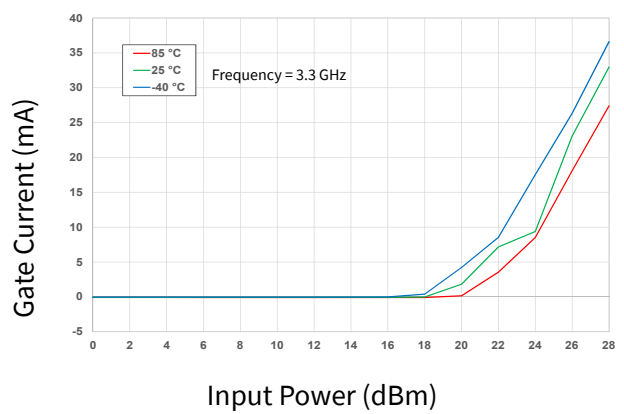

Figure 22. Gate Current vs Input Power as a Function of Temperature





Typical Performance of the CMPA3135060S

Test conditions unless otherwise noted: $V_D = 50\text{ V}$, $I_{DQ} = 260\text{ mA}$, Pulse Width = $300\ \mu\text{s}$, Duty Cycle = 20%, $P_{in} = 20\text{ dBm}$, $T_{BASE} = +25\text{ }^\circ\text{C}$

Figure 23. Output Power vs Input Power as a Function of IDQ

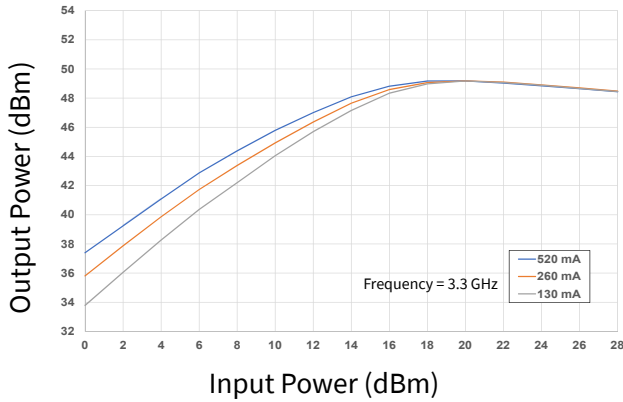

Figure 24. Power Added Eff. vs Input Power as a Function of IDQ

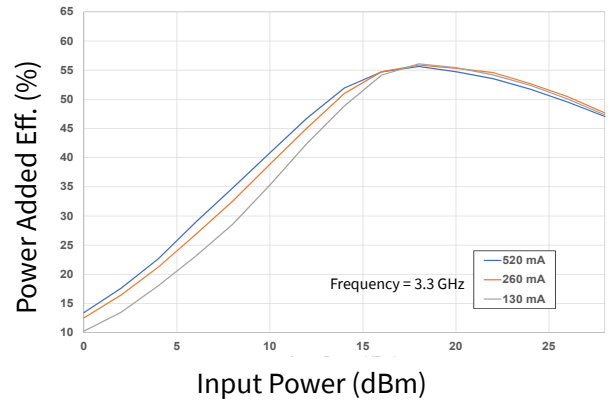

Figure 25. Large Signal Gain vs Input Power as a Function of IDQ

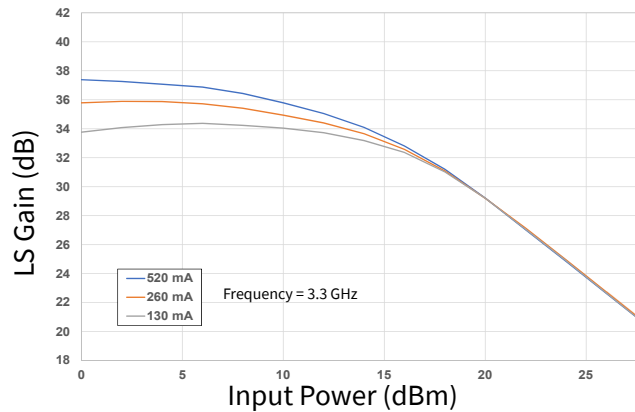

Figure 26. Drain Current vs Input Power as a Function of IDQ

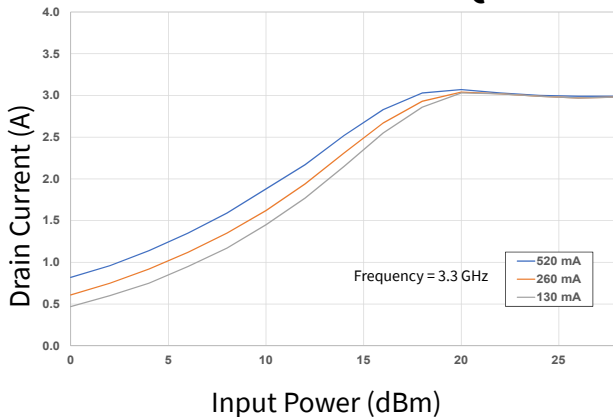
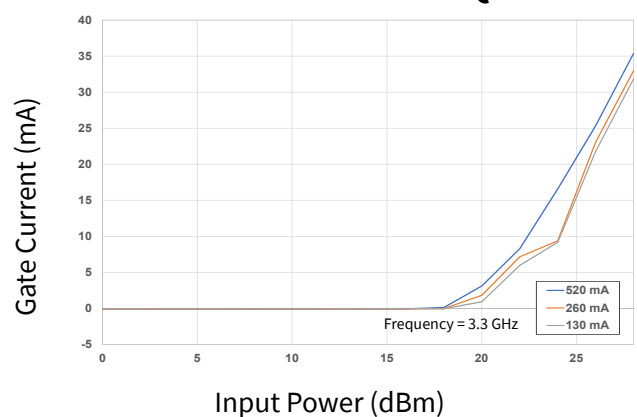

Figure 27. Gate Current vs Input Power as a Function of IDQ





Typical Performance of the CMPA3135060S

Test conditions unless otherwise noted: $V_D = 50\text{ V}$, $I_{DQ} = 260\text{ mA}$, Pulse Width = $300\text{ }\mu\text{s}$, Duty Cycle = 20%, Pin = 20 dBm, $T_{BASE} = +25\text{ }^\circ\text{C}$

Figure 28. 2nd Harmonic vs Frequency as a Function of Temperature

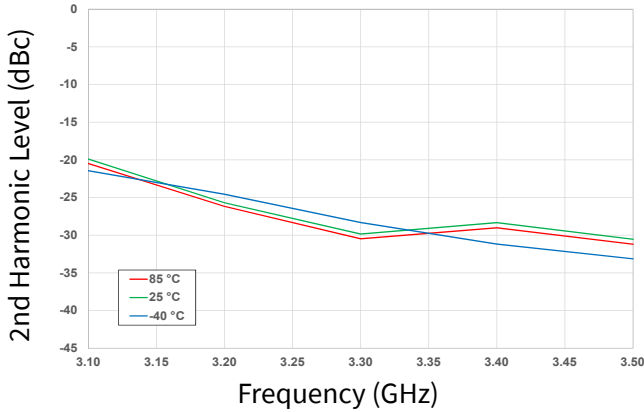

Figure 29. 3rd Harmonic vs Frequency as a Function of Temperature

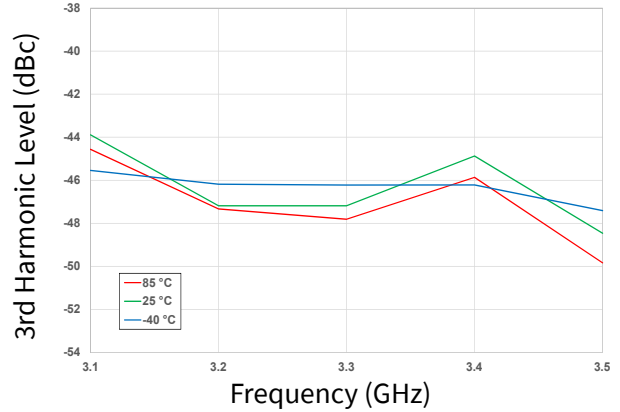

Figure 30. 2nd Harmonic vs Output Power as a Function of Frequency

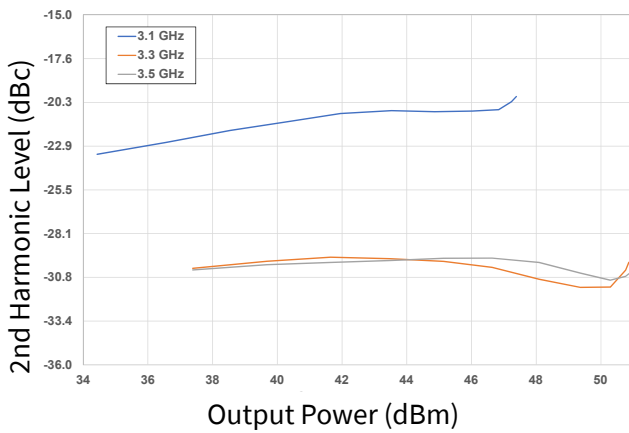

Figure 31. 3rd Harmonic vs Output Power as a Function of Frequency

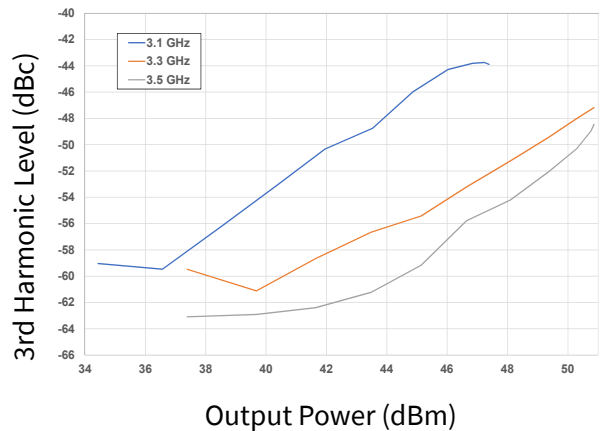

Figure 32. 2nd Harmonic vs Output Power as a Function of IDQ

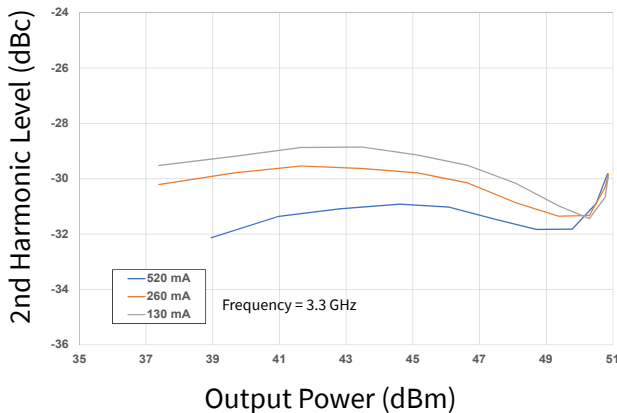
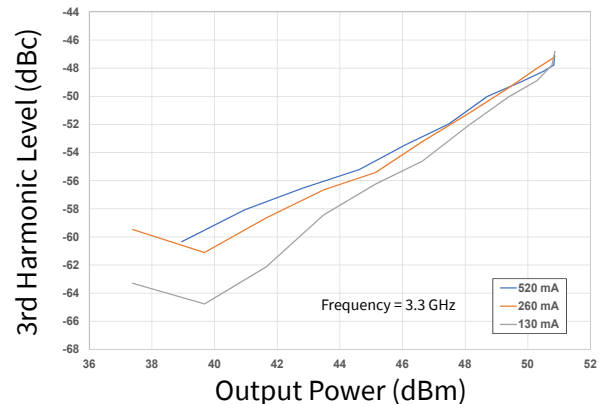

Figure 33. 3rd Harmonic vs Output Power as a Function of IDQ





Typical Performance of the CMPA3135060S

Test conditions unless otherwise noted: $V_D = 50\text{ V}$, $I_{DQ} = 260\text{ mA}$, $P_{in} = -30\text{ dBm}$, $T_{BASE} = +25\text{ }^\circ\text{C}$

Figure 34. Gain vs Frequency as a Function of Temperature

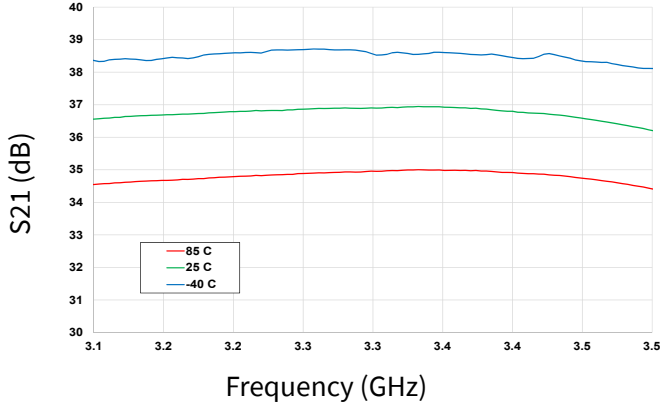

Figure 35. Gain vs Frequency as a Function of Temperature

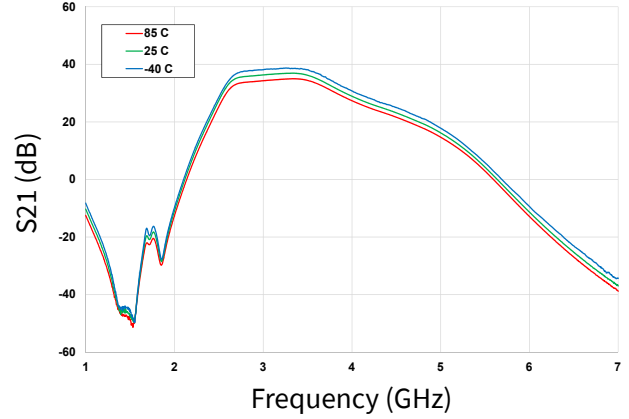

Figure 36. Input RL vs Frequency as a Function of Temperature

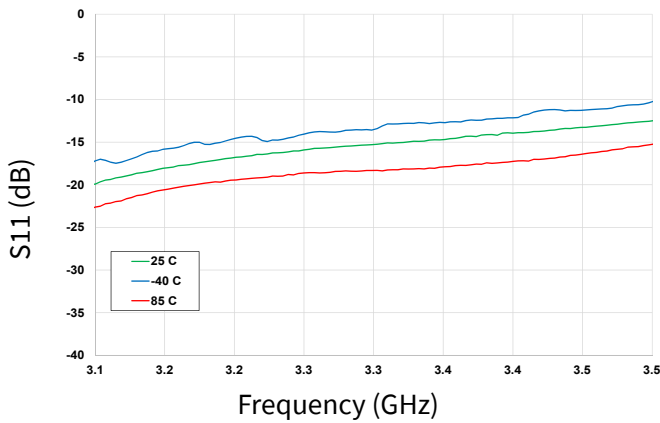

Figure 37. Input RL vs Frequency as a Function of Temperature

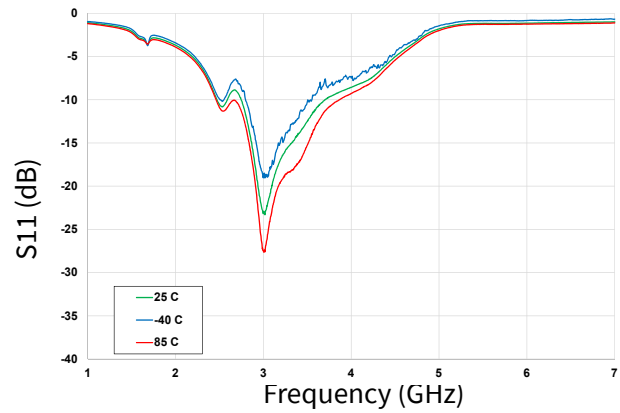

Figure 38. Output RL vs Frequency as a Function of Temperature

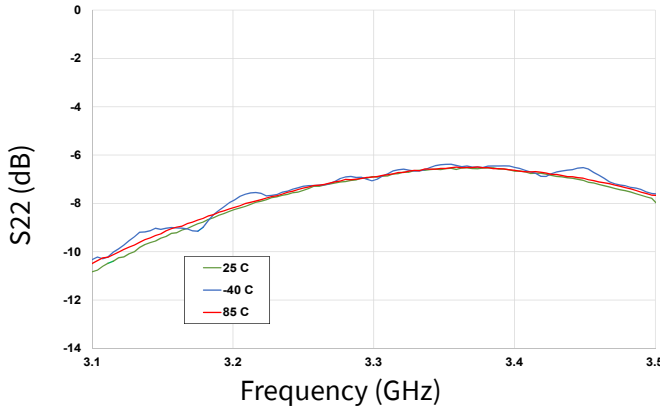
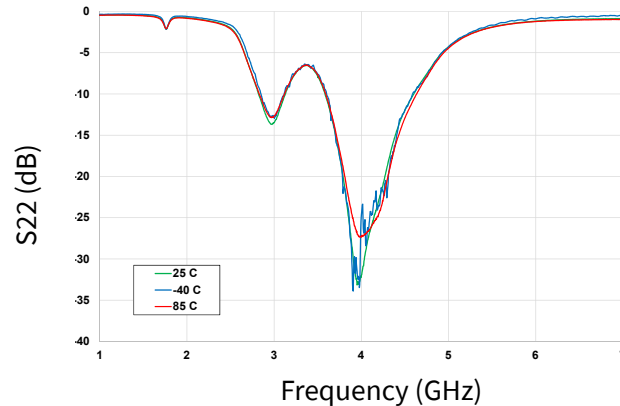

Figure 39. Output RL vs Frequency as a Function of Temperature



Typical Performance of the CMPA3135060S

Test conditions unless otherwise noted: $V_D = 50\text{ V}$, $I_{DQ} = 260\text{ mA}$, $P_{in} = -30\text{ dBm}$, $T_{BASE} = +25\text{ }^\circ\text{C}$

Figure 40. Gain vs Frequency as a Function of Voltage

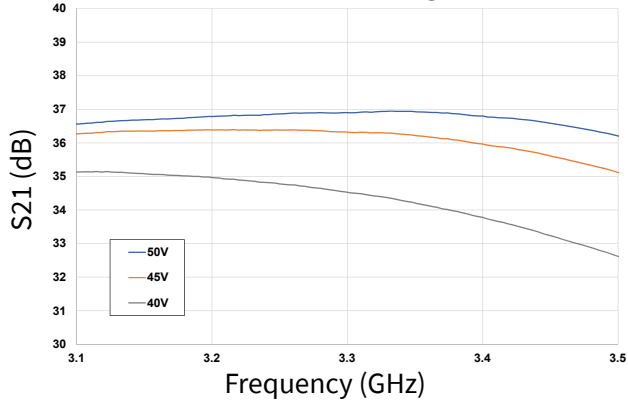

Figure 41. Gain vs Frequency as a Function of IDQ

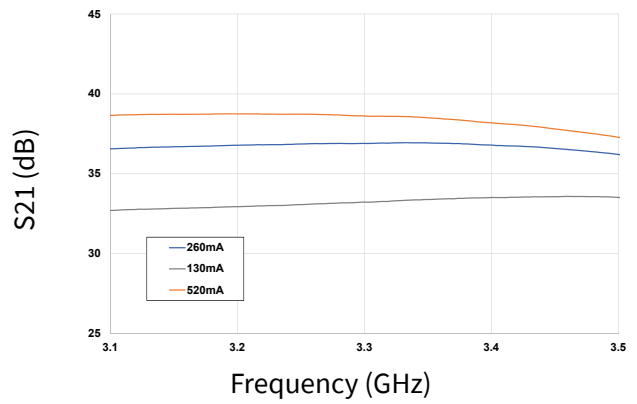

Figure 42. Input RL vs Frequency as a Function Voltage

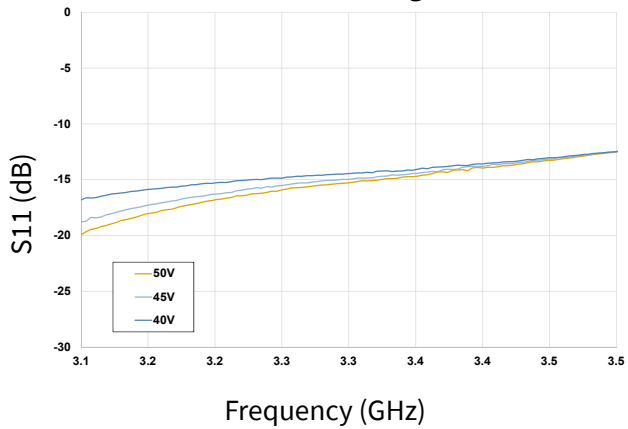

Figure 43. Input RL vs Frequency as a Function of IDQ

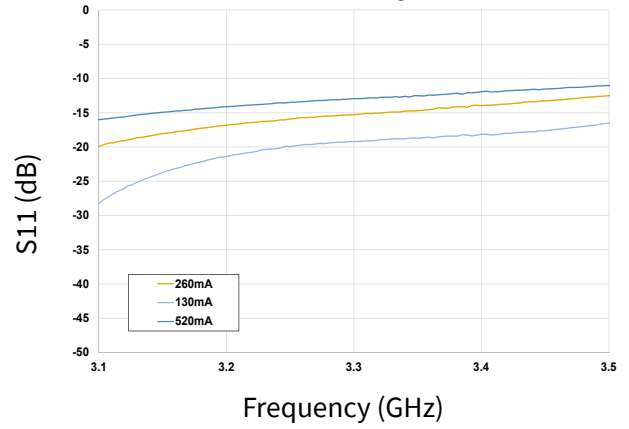

Figure 44. Output RL vs Frequency as a Function of Voltage

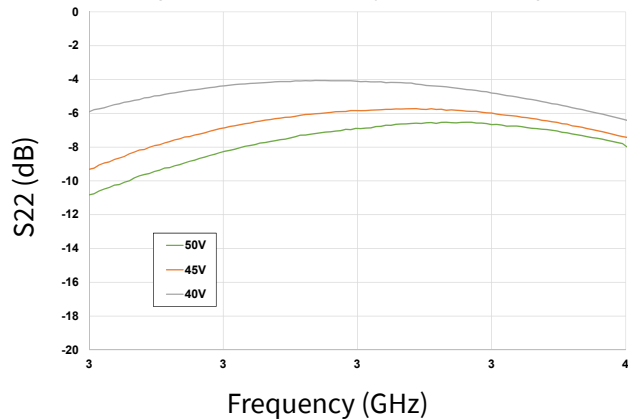
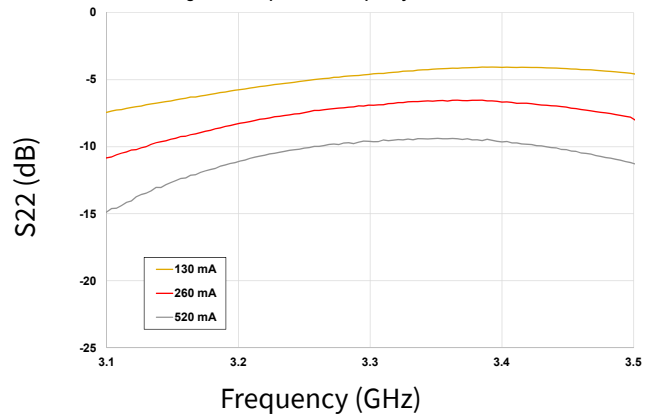
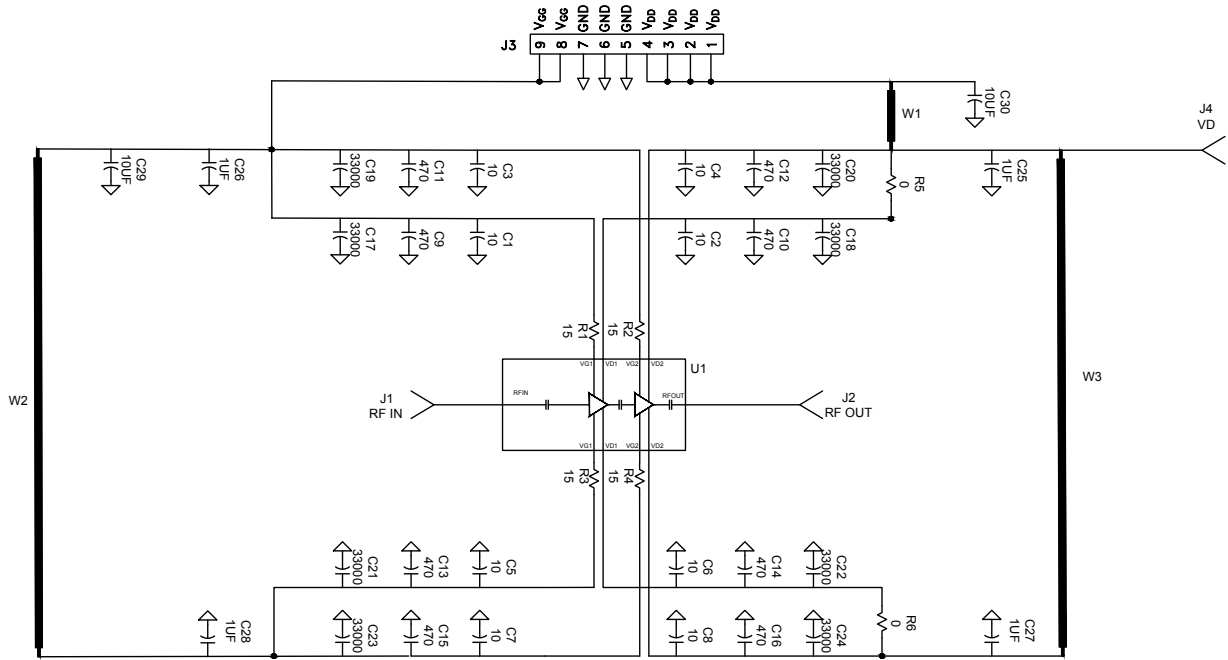

Figure 45. Output RL vs Frequency as a Function of IDQ



CMPA3135060S-AMP1 Application Circuit



CMPA3135060S-AMP1 Evaluation Board Layout

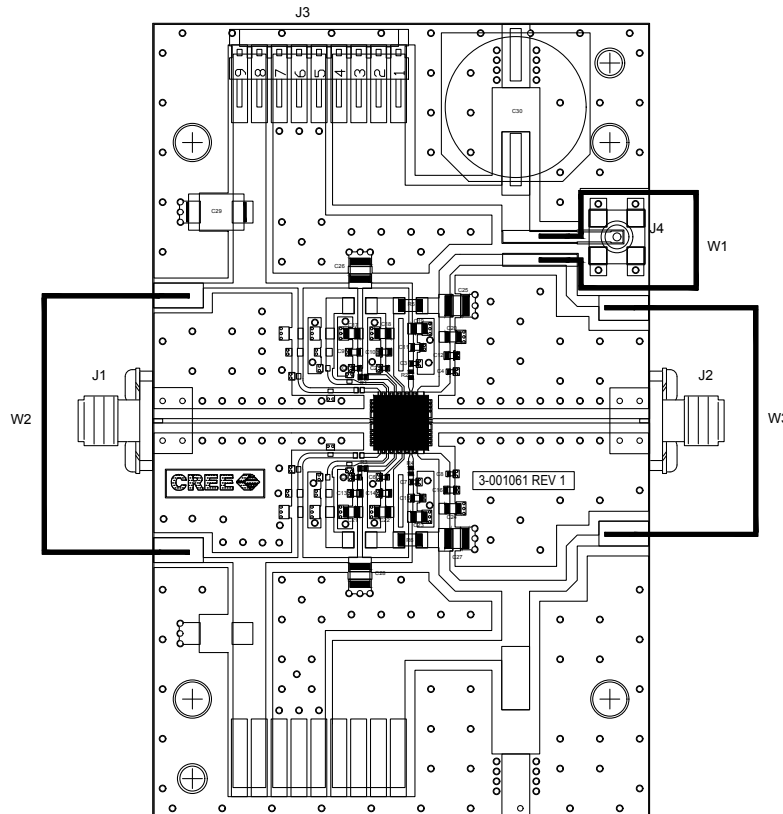

CMPA3135060S-AMP1 Evaluation Board Bill of Materials

Designator	Description	Qty
C1, C2, C3, C4, C5, C6, C7, C8	CAP, 10pF, +/-5%, pF, 200V, 0402	8
C9, C10, C11, C12, C13, C14, C15, C16	CAP, 470PF, 5%, 100V, 0603	8
C17, C18, C19, C20, C21, C22, C23, C24	CA, 330000PF, 0805,100V, X7R	8
C25, C26, C27, C28	CAP, 1.0UF, 100V, 10%, X7R, 1210	4
C29	CAP 10UF 16V TANTALUM, 2312	1
C30	CAP, 330 UF, +/-20%, 100V, ELECTROLYTIC, CASE SIZE K16	1
R1, R2, R3, R4	RES 15 OHM, +/-1%, 1/16W, 0402	4
R5, R6	RES 0.0 OHM 1/16W 1206 SMD	2
J1, J2	CONN, SMA, PANEL MOUNT JACK, FLANGE, 4-HOLE, BLUNT POST, 20MIL	4
J4	CONN, SMB, STRAIGHT JACK RECEPTACLE, SMT, 50 OHM, Au PLATED	1
J3	HEADER RT>PLZ .1CEN LK 9POS	1
W2, W3	WIRE, BLACK, 20 AWG ~ 2.5"	2
W1	WIRE, BLACK, 20 AWG ~ 3.0"	1
	PCB, TEST FIXTURE, RF-35TC, 0.010 THK, 7X7 Overmold QFN SOCKET BOARD	1
	2-56 SOC HD SCREW 3/16 SS	4
	#2 SPLIT LOCKWASHER SS	4
Q1	CMPA3135060S	1

Electrostatic Discharge (ESD) Classifications

Parameter	Symbol	Class	Test Methodology
Human Body Model	HBM	1B (≥ 500 V)	JEDEC JESD22 A114-D
Charge Device Model	CDM	II (≥ 200 V)	JEDEC JESD22 C101-C

Moisture Sensitivity Level (MSL) Classification

Parameter	Symbol	Level	Test Methodology
Moisture Sensitivity Level	MSL	3 (168 hours)	IPC/JEDEC J-STD-20

Product Dimensions CPA3135060S (Package 7 x 7 QFN)

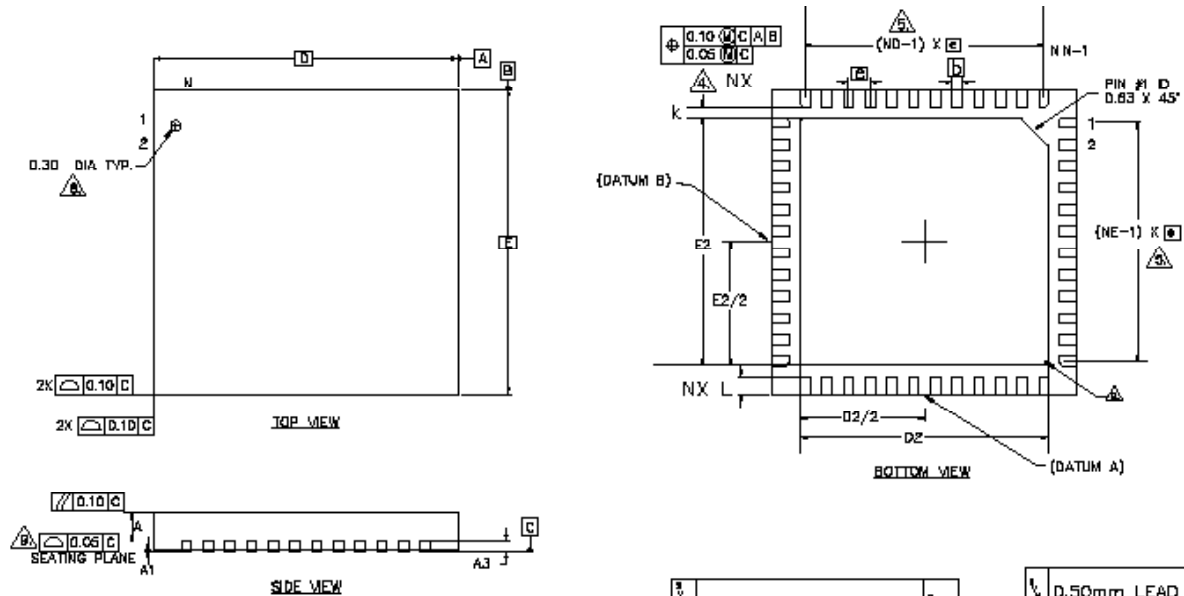

NOTES :

1. DIMENSIONING AND TOLERANCING CONFORM TO ASME Y14.5M - 1994.
2. ALL DIMENSIONS ARE IN MILLIMETERS. Ø IS IN DEGREES.
3. N IS THE TOTAL NUMBER OF TERMINALS.
4. DIMENSION b APPLIES TO METALLIZED TERMINAL AND IS MEASURED BETWEEN 0.15 AND 0.30mm FROM TERMINAL TP.
5. ND AND NE REFER TO THE NUMBER OF TERMINALS ON EACH D AND E SIDE RESPECTIVELY.
6. MAX. PACKAGE WARPAGE IS 0.03 mm.
7. MAXIMUM ALLOWABLE BURRS IS 0.076 mm IN ALL DIRECTIONS.
8. PIN #1 ID ON TOP WILL BE LASER MARKED.
9. BILATERAL COPLANARITY ZONE APPLIES TO THE EXPOSED HEAT SINK SURF AS WELL AS THE TERMINALS.
10. THIS DRAWING CONFORMS TO JEDEC REGISTERED OUTLINE MO-220
11. ALL PLATED SURFACES ARE TIN 0.010 mm +/- 0.005mm.

Symbol	MIN.	NOM.	MAX.
A	0.80	0.9	1.0
A1	0.00	0.03	0.08
A3	0.20 REF.		
⊕	0		12
K	0.20 MIN.		
D	7.0 BSC		
E	7.0 BSC		

Symbol	D.50mm LEAD PITCH			Notes
	MIN.	NOM.	MAX.	
b	0.50 BSC.			
N	48			3
ND	12			3
NE	12			3
L	0.36	0.41	0.48	
b	0.19	0.25	0.33	
D2	5.61	5.72	5.83	
E2	5.61	5.72	5.83	

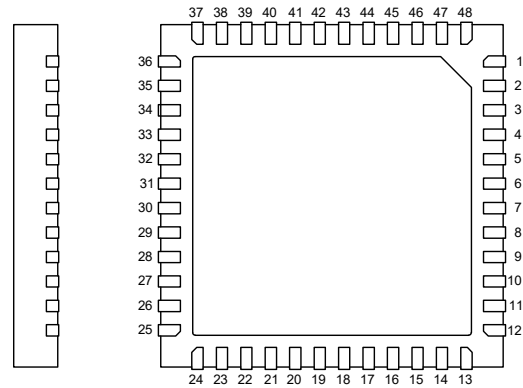
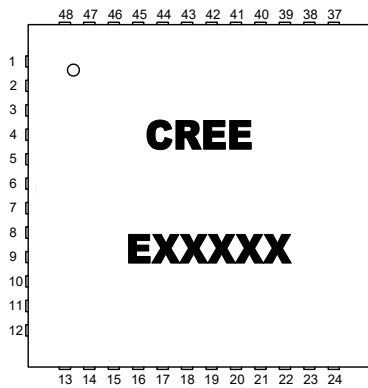

PIN	DESC.	PIN	DESC.	PIN	DESC.	PIN	DESC.
1	NC	15	NC	29	NC	43	NC
2	NC	16	NC	30	RFGND	44	VG1A
3	NC	17	VG1B	31	RFOUT	45	NC
4	NC	18	NC	32	RFGND	46	NC
5	RFGND	19	VD1B	33	NC	47	NC
6	RFIN	20	NC	34	NC	48	NC
7	RFGND	21	VG2B	35	NC		
8	NC	22	NC	36	NC		
9	NC	23	VD2B	37	NC		
10	NC	24	NC	38	VD2A		
11	NC	25	NC	39	NC		
12	NC	26	NC	40	VG2A		
13	NC	27	NC	41	NC		
14	NC	28	NC	42	VD1A		

Part Number System

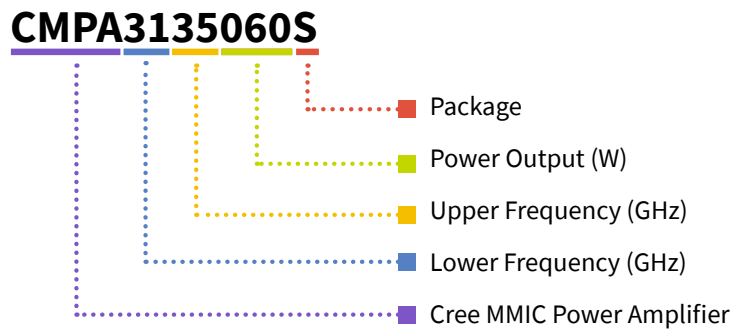

Table 1.



Parameter	Value	Units
Lower Frequency	3.1	GHz
Upper Frequency	3.5	GHz
Power Output	60	W
Package	Surface Mount	-

Note¹: Alpha characters used in frequency code indicate a value greater than 9.9 GHz. See Table 2 for value.

Table 2.

Character Code	Code Value
A	0
B	1
C	2
D	3
E	4
F	5
G	6
H	7
J	8
K	9
Examples:	1A = 10.0 GHz 2H = 27.0 GHz

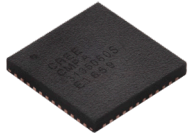
Product Ordering Information

Order Number	Description	Unit of Measure	Image
CMPA3135060S	Packaged GaN MMIC PA	Each	
CMPA3135060S-AMP1	Evaluation Board with GaN MMIC Installed	Each	

For more information, please contact:

4600 Silicon Drive
 Durham, North Carolina, USA 27703
www.wolfsspeed.com/RF

Sales Contact
RFSales@wolfsspeed.com

RF Product Marketing Contact
RFMarketing@wolfsspeed.com



For more information, please contact:

4600 Silicon Drive
Durham, North Carolina, USA 27703
www.wolfspeed.com/rf

Sales Contact
rfsales@cree.com

Notes & Disclaimer

Specifications are subject to change without notice. “Typical” parameters are the average values expected by Cree in large quantities and are provided for information purposes only. Cree products are not warranted or authorized for use as critical components in medical, life-saving, or life-sustaining applications, or other applications where a failure would reasonably be expected to cause severe personal injury or death. No responsibility is assumed by Cree for any infringement of patents or other rights of third parties which may result from use of the information contained herein. No license is granted by implication or otherwise under any patent or patent rights of Cree.

© 2020 – 2021 Cree, Inc. All rights reserved. Wolfspeed® and the Wolfspeed logo are registered trademarks of Cree, Inc.