

# RENESAS TECHNICAL UPDATE

1753, Shimonumabe, Nakahara-ku, Kawasaki-shi, Kanagawa 211-8668 Japan  
Renesas Electronics Corporation

Product Category	RF & Microwave device		Document No.	TN-RF*-A002A/E	Rev.	1.00
Title	Added the $\Phi$ 330-mm shipment reel		Information Category	Change of packages		
Applicable Product	RF & Microwave device (MMIC, RF transistor)	Lot No.	Reference Document	N.A		
		From August 2013				

## 1. Outline and Affected products;

$\Phi$ 330mm shipment reel will be added for RF transistor and MMIC of Compound Semiconductor Devices Business Division.

Please refer to the list of Appendixes 1 for the applicable product.

## 2. Details of the shipment reel added

In  $\Phi$ 330mm shipment reel, we will add the reel of following specifications.

Tape width: 8-mm and 12-mm

Dimensions: Please refer to Appendixes 2.

Appearance: Please refer to Appendixes 3.

## 3. Reason for changes

For the stable supply

## 4. Schedule of changes

We are planning to apply from August, 2013 production.

## 5. Electrical characteristics and reliability

There is no influence of the electrical characteristics and reliability by this change.

Also, there is no change of manufacturing process and a manufacture flow.

**Appendix 1: Applicable product list of added  $\Phi$ 330-mm shipment reel.**

Product of 8mm width reel
2SC5508-T2B-A
NE3503M04-T2B-A
NE3508M04-T2B-A
NE3509M04-T2B-A
NE3510M04-T2B-A
NE3513M04-T2B-A
NE3519M04-T2B-A
NE3511S02-T1D-A
NE3512S02-T1D-A
NE3514S02-T1D-A
NE3515S02-T1D-A
NE3516S02-T1D-A
NE3517S03-T1D-A
NE3520S03-T1D-A
UPB1051T6T-E1-A
NESG7030M04-T2B-A

Product of 12mm width reel
NE325S01-T1B
NE425S01-T1B
NE3210S01-T1B
NE4210S01-T1B
NE32584C-T1A
NE321084C-T1A
NE350184C-T1A-A
UPG2118K-E3-A
UPD5720K-E3-A
UPD5716GR-E1-A
UPC3228T5S-E2-A
UPD5739T7A-E1-A
UPD5754T7A-E1-A
UPC3243T7A-E1-A
UPD5761T7A-E1-A
UPD5753T7G-E1-A
UPC3250T7L-E1-A
NE5511279A-T1A-A
NE5520279A-T1A-A
NE5520379A-T1A-A
NE552R479A-T1A-A
NE552R679A-T1A-A
NE5531079A-T1A-A
NE5550979A-T1A-A
NE5550279A-T1A-A
NE5550779A-T1A-A
UPG2424T7E-E2-A
UPG2054K-E3-A
UPD5715GR-E1-A



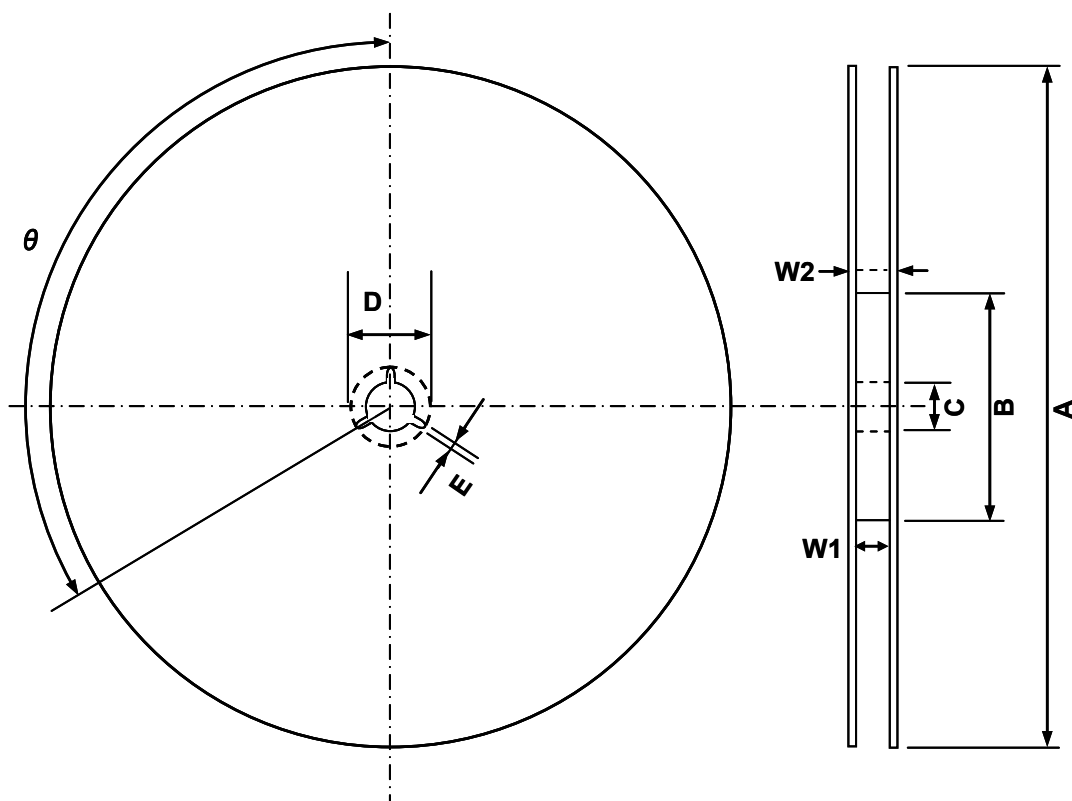



**Appendixes 2: Dimensions of added  $\Phi 330$ -mm shipment reel.**



(Unit: mm, unless otherwise specified)

ITEM		SYMBOL	SIZE	
Width of Tape			8mm	12mm
Flange	Diameter	A	$\phi 330 \pm 2$	
	Inner Space of Flanges	W 1	$9.4 \pm 1.0$	$13.4 \pm 1.0$
	Outer Width of Flanges	W 2	$13.4 \pm 1.0$	$17.4 \pm 1.0$
Hub	Outer Diameter	B	$\phi 100 \pm 1$	
	Spindle Hole Diameter	C	$\phi 13 \pm 0.20$	
	Key Slit Diameter	D	$\phi 21 \pm 0.8$	
	Key Slit Width	E	$2 \pm 0.5$	
	Key Slit Location	$\theta$	$120^\circ$	

**Appendix 3: Appearance of added  $\Phi 330$ -mm shipment reel.**

	The existing reel	Added reel
Outside	<p>The edge of a core is flat form.</p> <p>Reel appearance</p>  <p>Close-up of core part</p> 	<p>The edge of a core has convex part.</p> <p>Reel appearance</p>  <p>Close-up of core part</p> 
Inner side	<p>The inner side form of a flange is flat.</p> <p>Reel inner side</p>  <p>Close-up of inner flange part</p> 	<p>Inside a flange has spoke-like convex part.</p> <p>Reel inner side</p>  <p>Close-up of inner flange part</p> 