

PAGE 1/5	ISSUE 03-12-15C	SERIES MCX	PART NUMBER R113664120
----------	-----------------	------------	------------------------

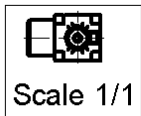

All dimensions are in mm.

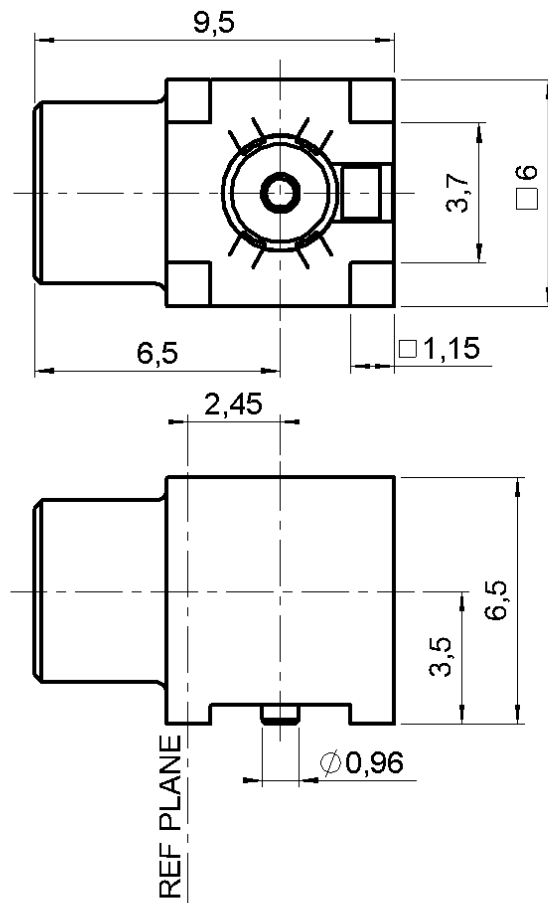
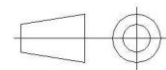

COMPONENTS	MATERIALS	PLATING (μm)
Body	BRASS	NPGR
Center contact	BERYLLIUM COPPER	GOLD OVER NICKEL
Outer contact	-	-
Insulator	PTFE	
Gasket	-	
Others parts	BRASS	GOLD OVER NICKEL
-	-	-
-	-	-

PAGE 2/5	ISSUE 03-12-15C	SERIES MCX	PART NUMBER R113664120
----------	------------------------	-------------------	-------------------------------

PACKAGING

Standard	Unit	Other
500	Contact us	Contact us

ELECTRICAL CHARACTERISTICS

Impedance		50	Ω
Frequency		0-6	GHz
VSWR	1.25	+	0.0000 x F(GHz) Maxi
Insertion loss		0.03	√F(GHz) dB Maxi
RF leakage	- (NA	- F(GHz)) dB Maxi
Voltage rating		335	Veff Maxi
Dielectric withstanding voltage		1000	Veff mini
Insulation resistance		1000	MΩ mini

ENVIRONMENTAL

Operating temperature	-55/+155	°C
Hermetic seal	NA	Atm.cm3/s
Panel leakage	NA	

SPECIFICATION

MECHANICAL CHARACTERISTICS

Center contact retention			
Axial force – Mating End		10	N mini
Axial force – Opposite end		10	N mini
Torque		NA	N.cm mini
Recommended torque			
Mating		NA	N.cm
Panel nut		NA	N.cm
Mating life		500	Cycles mini
Weight		1.6800	g

OTHER CHARACTERISTICS

Assembly instruction:

Others:

PAGE 3/5	ISSUE 03-12-15C	SERIES MCX	PART NUMBER R113664120
----------	-----------------	------------	------------------------

MCX SERIES - INFORMATION

Coplanar line : pattern and signal are on the same side . Thickness of PCB :.079(2mm)
 The material of PCB is the epoxy resin of glass fabrics bacs . (Er = 4.8) . The solder resist should be printed except for the land pattern on the PCB .

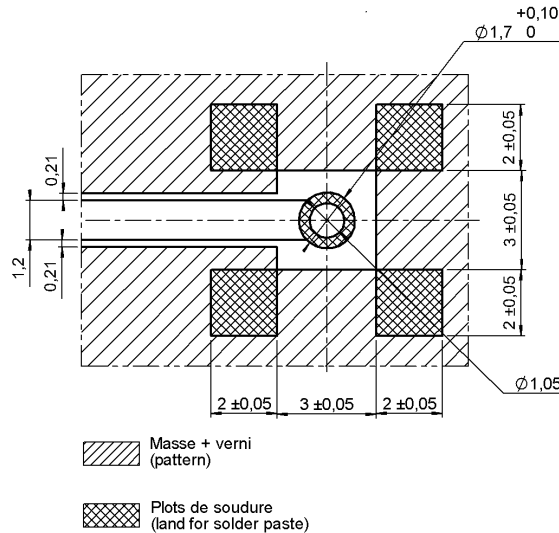

SHADOW OF MCX RECEPTACLE FOR VIDEO CAMERA

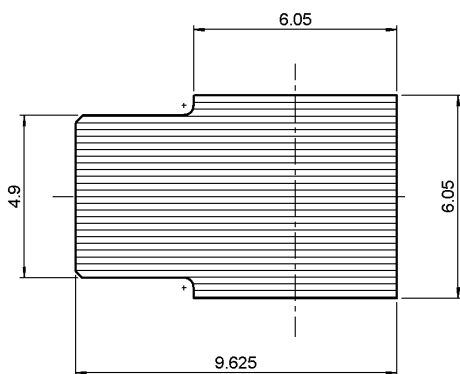

ASPIRATION AREA

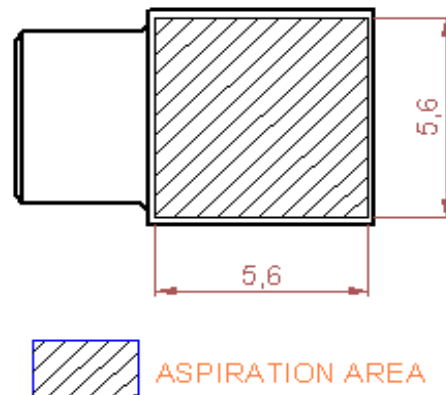

SOLDER PROCEDURE

1. Deposit solder paste 'Sn Ag4 Cu0.5' on mounting zone by screen printing application. We recommend a low residue flux. We advise a thickness of 150 micromm (5.850 microinch). Verify that the edges of the zone are clean.
2. Placement of the receptacle on the mounting zone with an automatic machine of 'pick and place' type. Video camera is preferred to check the positioning of the component. Adhesive agents are forbidden on the receptacle.
3. Soldering by infra-red reflow.
4. Cleaning of printed circuit boards.
5. Checking of solder joints and position of the component by visual inspection.

TEMPERATURE PROFILE

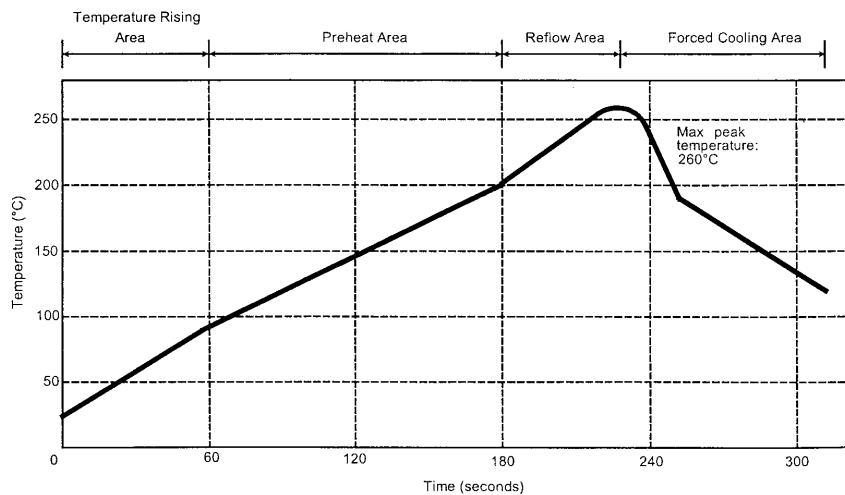

Parameter	Value	Unit
Temperature rising Area	1 - 4	°C/sec
Max Peak Temperature	260	°C
Max dwell time @260°C	10	sec
Min dwell time @235°C	20	sec
Max dwell time @235°C	60	sec
Temperature drop in cooling Area	-1 to - 4	°C/sec
Max dwell time above 100°C	420	sec

PAGE 5/5	ISSUE 03-12-15C	SERIES MCX	PART NUMBER R113664120
----------	-----------------	------------	------------------------

PACKAGE

