



Model Number	Input Range (Vdc)		Vout (Vdc)	Iout (A)
	Min	Max		
ICH0141V1xC	9	36	12	41
ICH0421V1xC	9	36	24	21
ICH0518V1xC	9	36	28	18

## Features

- 4:1 Input voltage range of 9-36V
- Single outputs of 12V, 24V or 28V
- 2250V Isolation voltage (Input-to-Output)
- Industry Standard half brick package  
2.4" x 2.5" x 0.52" (61mm x 64mm x 13.2mm)
- Efficiency up to 95.7%
- Excellent thermal performance
- Over-Current and Short Circuit Protection
- Over-Temperature protection
- Monotonic startup into pre-bias loads
- 200kHz Fixed switching frequency
- Remote On/Off control (Positive or Negative logic)
- Good shock and vibration damping
- Operating Temperature Range -40°C to +105°C
- RoHS Compliant



## Product Overview

The 4:1 input voltage 500 Watt single output ICH DC-DC converter provides a precisely regulated dc output. The output voltage is fully isolated from the input, allowing the output to be positive or negative polarity and with various ground connections. The enclosed half brick package meets the most rigorous performance standards in an industry standard footprint for mobile (12V<sub>in</sub>), process control (24V<sub>in</sub>), and Commercial-Off-The-Shelf (28V<sub>in</sub>) applications.

The ICH Series includes an external TRIM adjust and remote ON/OFF control. Threaded through holes are provided to allow easy mounting or the addition of a heat sink for extended

temperature operation.

The converters high efficiency and high power density are accomplished through use of high-efficiency synchronous rectification technology, advanced electronic circuit, packaging and thermal design thus resulting in a high reliability product. The converter operates at a fixed frequency of 200kHz and follows conservative component derating guidelines.

Product is designed and manufactured in the USA.

## Part Number Structure and Ordering Guide

Description	Part Number Structure										Definition and Options		
Product Family	I	C									IC= Industrial Class		
Form Factor			H								H = Half Brick		
Vout*				0	1						01 = 12Vout, 02 = 5Vout, 03 = 3.3Vout, 04 = 24Vout, 05 = 28Vout		
Output Current						4	1				Max Iout in Amps		
Vin Range								V	1		V1 = 9 to 36V		
On/Off Control Logic										P	N = Negative, P = Positive (Standard)		
Specific Customer Configuration										X	X	Customer Code, Omit for Standard	
RoHS Compliant												C	RoHS 6/6 Compliant

\*NOTE: Some part number combinations might not be available. Please contact the factory for non-standard or special order products.

**\* Last Time Buy date is 3/31/2019. Please click here to view the Discontinuance Notification.**

### Electrical Specifications – All Models

Conditions:  $T_a = 25^{\circ}\text{C}$ , airflow = 300 LFM (1.5m/s),  $V_{in} = 24\text{VDC}$ , unless otherwise specified. Specifications subject to change without notice.

Parameter	Notes	Min	Typ	Max	Units
<b>Absolute Maximum Ratings</b>					
Input Voltage	Continuous	0		40	V
	Transient (100ms)			50	V
Operating Temperature (See Note 1)	Baseplate (100% load) Standard model	-40		105	$^{\circ}\text{C}$
Storage Temperature		-55		125	$^{\circ}\text{C}$
<b>Isolation Characteristics and Safety</b>					
Isolation Voltage	Input to Output	2250			V
	Input to Baseplate & Output to Baseplate	1500			V
Isolation Capacitance			4500		pF
Isolation Resistance		10	20		M $\Omega$
Insulation Safety Rating			Basic		
Agency Approvals	Designed to meet UL/cUL 60950, IEC/EN 60950-1				
<b>Feature Characteristics</b>					
Fixed Switching Frequency	Output Voltage Ripple has twice this frequency		200		kHz
Output Voltage Trim Range				$\pm 10$	%
Remote Sense Compensation	This function is not provided		N/A		%
Output Overvoltage Protection	Non-latching	117	124	130	%
Overtemperature Shutdown (Baseplate)	Non-latching		110	120	$^{\circ}\text{C}$
Auto-Restart Period	Applies to all protection features	450	500	550	ms
Turn-On Time from $V_{in}$	Time from UVLO to $V_o=90\% V_{out(NOM)}$ Resistive load		517	530	ms
Turn-On time from ON/OFF Control	Trim from ON to $V_o=90\% V_{out(NOM)}$ Resistive load		17	20	ms
Rise Time	$V_{out}$ from 10% to 90%	4	7.5	11	ms
<b>ON/OFF Control - Positive Logic</b>					
ON state	Pin open = ON or external voltage applied	2		12	V
Control Current	Leakage current			0.16	mA
OFF state		0		0.8	V
Control Current	Sinking	0.3		0.36	mA
<b>ON/OFF Control - Negative Logic</b>					
ON state	Pin shorted to -INPUT or			0.8	V
OFF state	Pin open = Off or	2		12	V
<b>Thermal Characteristics</b>					
Thermal resistance Baseplate to Ambient	Converter soldered to 3.95" x 2.5" x 0.07" 4 layer/ 2oz copper FR4 PCB.		5.2		$^{\circ}\text{C}/\text{W}$

1. A thermal management device, such as a heatsink, is required to ensure proper operation of this device. The thermal management medium is required to maintain baseplate  $< 105^{\circ}\text{C}$  for full rated power.

### Electrical Specifications – ICH0141V1

Conditions:  $T_a = 25^\circ\text{C}$ , airflow = 300 LFM (1.5m/s),  $V_{in} = 24\text{VDC}$ , unless otherwise specified. Specifications subject to change without notice.

Parameter	Notes	Min	Typ	Max	Units	
<b>Input Characteristics</b>						
Operating Input Voltage Range		9	24	36	V	
Input Under Voltage Lockout	Non-latching					
Turn-on Threshold		8.2	8.5	8.8	V	
Turn-off Threshold		7.7	8	8.3	V	
Lockout Hysteresis Voltage		0.4	0.55	0.7	V	
Maximum Input Current	$V_{in} = 9\text{V}$ , 80% Load			50.4	A	
	$V_{in} = 12\text{V}$ , 100% Load			46.2	A	
	$V_{in} = 24\text{V}$ , Output Shorted		65		$\text{mA}_{\text{RMS}}$	
Input Stand-by Current	Converter Disabled		2	4	mA	
Input Current @ No Load	Converter Enabled		240	280	mA	
Minimum Input Capacitance (external)	ESR < 0.1 $\Omega$	470			$\mu\text{F}$	
Inrush Transient	$V_{in} = 36\text{V}$ (0.4V/ $\mu\text{s}$ ) no input external capacitor		0.4	1	$\text{A}^2\text{s}$	
Input Terminal Ripple Current, $i_c$	25 MHz bandwidth, 100% Load (Fig. 2)		620		$\text{mA}_{\text{RMS}}$	
<b>Output Characteristics</b>						
Output Voltage Range		11.64	12.00	12.36	V	
Output Voltage Set Point Accuracy	(50% load)	11.88	12.00	12.12	V	
Output Regulation						
Over Line	$V_{in} = 9\text{V}$ to 36V		0.05	0.15	%	
Over Load	$V_{in} = 24\text{V}$ , Load 0% to 100%		0.08	0.15	%	
Temperature Coefficient			0.015	0.03	%/ $^\circ\text{C}$	
Overvoltage Protection		14.0		15.6	V	
Output Ripple and Noise - 20MHz bandwidth	(Fig. 3) 100% Load, $C_{\text{ext}} = 470 \mu\text{F}/70\text{m}\Omega + 1 \mu\text{F}$ ceramic		120	180	$\text{mV}_{\text{PK-PK}}$	
			30	60	$\text{mV}_{\text{RMS}}$	
External Load Capacitance	Full Load (resistive) -40 $^\circ\text{C}$ < $T_a$ < +105 $^\circ\text{C}$	$C_{\text{ext}}$ ESR	470		4700	$\mu\text{F}$
			10		100	$\text{m}\Omega$
Output Current Range (See Fig. A)	$V_{in} = 12\text{V} - 36\text{V}$	0		41	A	
	$V_{in} = 9\text{V}$	0		33.3	A	
Current Limit Inception	$V_{in} = 12\text{V} - 36\text{V}$	45.1	49.2	53.3	A	
	$9\text{V} \leq V_{in} < 12\text{V}$	40.6		53.3	A	
RMS Short-Circuit Current	Non-latching, Continuous		4	7	$\text{A}_{\text{RMS}}$	
<b>Dynamic Response</b>						
Load change 50% - 75% - 50%, $di/dt = 1\text{A}/\mu\text{s}$	$C_o = 470 \mu\text{F}/70\text{m}\Omega + 1 \mu\text{F}$ ceramic		$\pm 320$	$\pm 450$	mV	
Load change 50% - 100% - 50%, $di/dt = 1\text{A}/\mu\text{s}$	$C_o = 470 \mu\text{F}/70\text{m}\Omega + 1 \mu\text{F}$ ceramic		$\pm 700$		mV	
Setting Time to 1% of $V_{\text{out}}$			600		$\mu\text{s}$	
<b>Efficiency</b>						
100% Load	$V_{in} = 24\text{V}$	93.2	93.9	94.6	%	
	$V_{in} = 12\text{V}$	91.4	92.1	92.8	%	
50% Load	$V_{in} = 24\text{V}$	94.7	95.4	96.1	%	
	$V_{in} = 12\text{V}$	93.9	94.6	95.2	%	

### Electrical Specifications – ICH0421V1

Conditions:  $T_a = 25^\circ\text{C}$ , airflow = 300 LFM (1.5m/s),  $V_{in} = 24\text{VDC}$ , unless otherwise specified. Specifications subject to change without notice.

Parameter	Notes	Min	Typ	Max	Units
<b>Input Characteristics</b>					
Operating Input Voltage Range		9	24	36	V
Input Under Voltage Lockout	Non-latching				
Turn-on Threshold		8.2	8.5	8.8	V
Turn-off Threshold		7.7	8	8.3	V
Lockout Hysteresis Voltage		0.4	0.55	0.7	V
Maximum Input Current	$V_{in} = 9\text{V}$ , 80% Load			50.4	A
	$V_{in} = 12\text{V}$ , 100% Load			47.0	A
	$V_{in} = 24\text{V}$ , Output Shorted		75		$\text{mA}_{\text{RMS}}$
Input Stand-by Current	Converter Disabled		2	4	mA
Input Current @ No Load	Converter Enabled		240	300	mA
Minimum Input Capacitance (external)	ESR < 0.1 $\Omega$	470			$\mu\text{F}$
Inrush Transient	$V_{in} = 36\text{V}$ (0.4V/ $\mu\text{s}$ ) no input external capacitor		0.4	1	$\text{A}^2\text{s}$
Input Terminal Ripple Current, $i_c$	25 MHz bandwidth, 100% Load (Fig. 2)		680		$\text{mA}_{\text{RMS}}$
<b>Output Characteristics</b>					
Output Voltage Range		23.28	24.00	24.72	V
Output Voltage Set Point Accuracy	(50% load)	23.76	24.00	24.24	V
Output Regulation					
Over Line	$V_{in} = 9\text{V}$ to 36V		0.05	0.15	%
Over Load	$V_{in} = 24\text{V}$ , Load 0% to 100%		0.08	0.15	%
Temperature Coefficient			0.015	0.03	%/ $^\circ\text{C}$
Overvoltage Protection		28.1		31.2	V
Output Ripple and Noise - 20MHz bandwidth	(Fig. 3) 100% Load, $C_{\text{ext}} = 470 \mu\text{F}/70\text{m}\Omega + 1 \mu\text{F}$ ceramic		240	360	$\text{mV}_{\text{PK-PK}}$
			50	80	$\text{mV}_{\text{RMS}}$
External Load Capacitance	Full Load (resistive) $-40^\circ\text{C} < T_a < +105^\circ\text{C}$	$C_{\text{ext}}$	470	2200	$\mu\text{F}$
		ESR	10	100	$\text{m}\Omega$
Output Current Range (See Fig. A)	$V_{in} = 12\text{V} - 36\text{V}$	0		21	A
	$V_{in} = 9\text{V}$	0		16.7	A
Current Limit Inception	$V_{in} = 12\text{V} - 36\text{V}$	23.1	25.2	27.3	A
	$9\text{V} \leq V_{in} < 12\text{V}$	20.8		27.3	A
RMS Short-Circuit Current	Non-latching, Continuous		3.8	6	$\text{A}_{\text{RMS}}$
<b>Dynamic Response</b>					
Load change 50% - 75% - 50%, $di/dt = 1\text{A}/\mu\text{s}$	$C_o = 470 \mu\text{F}/70\text{m}\Omega + 1 \mu\text{F}$ ceramic		$\pm 280$	$\pm 420$	mV
Load change 50% - 100% - 50%, $di/dt = 1\text{A}/\mu\text{s}$	$C_o = 470 \mu\text{F}/70\text{m}\Omega + 1 \mu\text{F}$ ceramic		$\pm 500$		mV
Setting Time to 1% of $V_{\text{out}}$			600		$\mu\text{s}$
<b>Efficiency</b>					
100% Load	$V_{in} = 24\text{V}$	93.6	94.3	95.0	%
	$V_{in} = 12\text{V}$	92.3	93.0	93.7	%
50% Load	$V_{in} = 24\text{V}$	94.5	95.4	96.3	%
	$V_{in} = 12\text{V}$	94.5	95.2	95.9	%

### Electrical Specifications – ICH0518V1

Conditions:  $T_a = 25^\circ\text{C}$ , airflow = 300 LFM (1.5m/s),  $V_{in} = 24\text{VDC}$ , unless otherwise specified. Specifications subject to change without notice.

Parameter	Notes	Min	Typ	Max	Units
<b>Input Characteristics</b>					
Operating Input Voltage Range		9	24	36	V
Input Under Voltage Lockout	Non-latching				
Turn-on Threshold		8.2	8.5	8.8	V
Turn-off Threshold		7.7	8	8.3	V
Lockout Hysteresis Voltage		0.4	0.55	0.7	V
Maximum Input Current	$V_{in} = 9\text{V}$ , 80% Load			50.4	A
	$V_{in} = 12\text{V}$ , 100% Load			46.2	A
	$V_{in} = 24\text{V}$ , Output Shorted		55		$\text{mA}_{\text{RMS}}$
Input Stand-by Current	Converter Disabled		2	4	mA
Input Current @ No Load	Converter Enabled		240	280	mA
Minimum Input Capacitance (external)	ESR < 0.1 $\Omega$	470			$\mu\text{F}$
Inrush Transient	$V_{in} = 36\text{V}$ (0.4V/ $\mu\text{s}$ ) no input external capacitor		0.4	1	$\text{A}^2\text{s}$
Input Terminal Ripple Current, $\hat{i}_c$	25 MHz bandwidth, 100% Load (Fig. 2)		550		$\text{mA}_{\text{RMS}}$
<b>Output Characteristics</b>					
Output Voltage Range		27.16	28.00	28.84	V
Output Voltage Set Point Accuracy	(50% load)	27.72	28.00	28.28	V
Output Regulation					
Over Line	$V_{in} = 9\text{V}$ to 36V		0.05	0.15	%
Over Load	$V_{in} = 24\text{V}$ , Load 0% to 100%		0.08	0.15	%
Temperature Coefficient			0.015	0.03	%/ $^\circ\text{C}$
Overvoltage Protection		32.8		36.4	V
Output Ripple and Noise - 20MHz bandwidth	(Fig. 3) 100% Load, $C_{\text{ext}} = 470 \mu\text{F}/70\text{m}\Omega + 1 \mu\text{F}$ ceramic		280	380	$\text{mV}_{\text{PK-PK}}$
			50	85	$\text{mV}_{\text{RMS}}$
External Load Capacitance	Full Load (resistive) $-40^\circ\text{C} < T_a < +105^\circ\text{C}$	$C_{\text{ext}}$ ESR	470	2200	$\mu\text{F}$
			10	100	$\text{m}\Omega$
Output Current Range (See Fig. A)	$V_{in} = 12\text{V} - 36\text{V}$	0		18	A
	$V_{in} = 9\text{V}$	0		14.3	A
Current Limit Inception	$V_{in} = 12\text{V} - 36\text{V}$	19.8		23.4	A
	$9\text{V} \leq V_{in} < 12\text{V}$	17.8		23.4	A
RMS Short-Circuit Current	Non-latching, Continuous		2.2	6	$\text{A}_{\text{RMS}}$
<b>Dynamic Response</b>					
Load change 50% - 75% -50%, $di/dt = 1\text{A}/\mu\text{s}$	$C_o = 470 \mu\text{F}/70\text{m}\Omega + 1 \mu\text{F}$ ceramic		$\pm 270$	$\pm 410$	mV
Load change 50% - 100% - 50%, $di/dt = 1\text{A}/\mu\text{s}$	$C_o = 470 \mu\text{F}/70\text{m}\Omega + 1 \mu\text{F}$ ceramic		$\pm 500$		mV
Setting Time to 1% of $V_{\text{out}}$			800		$\mu\text{s}$
<b>Efficiency</b>					
100% Load	$V_{in} = 24\text{V}$	94.3	95.0	95.7	%
	$V_{in} = 12\text{V}$	93.1	93.8	94.5	%
50% Load	$V_{in} = 24\text{V}$	95.0	95.7	96.4	%
	$V_{in} = 12\text{V}$	94.1	94.8	95.5	%

**Environmental and Mechanical Specifications:** Specifications subject to change without notice.

Parameter	Notes	Min	Typ	Max	Units
<b>Environmental</b>					
Operating Humidity	Non-condensing			95	%
Storage Humidity	Non-condensing			95	%
RoHS Compliance	See Murata Website <a href="http://www.murata-ps.com/en/support/rohs-compliance.html">http://www.murata-ps.com/en/support/rohs-compliance.html</a> for the complete RoHS Compliance Statement				
Shock and Vibration (See Note 1)	Designed to meet MIL-STD-810G for functional shock and vibration				
Water Washability	Not recommended for water wash process. Contact the factory for more information.				
<b>Mechanical</b>					
Unit Weight		3.85			Ounces
		109.2			Grams
PCB					
Operating Temperature				130	°C
Tg		170			°C
Through Hole Pin Diameters	Pins 1,4,5 and 9	0.079	0.081	0.083	Inches
		2.006	2.057	2.108	mm
	Pins 3 and 7	0.038	0.04	0.042	Inches
		0.965	1.016	1.067	mm
Through Hole Pins Material	Pins 1,4,5 and 9	Copper Alloy			
	Pins 3 and 7	Brass Alloy TB3 or "Eco Brass"			
Through Hole Pin Finish	All pins	10µ" Gold over Nickel			
Case Dimensions		2.4 x 2.5 x 0.52			Inches
		60.96 x 63.50 x 13.21			mm
Case Material	Plastic: Vectra LCP FIT30: 1/2-16 EDM Finish				
Baseplate	Material	Aluminum			
	Flatness		0.008		Inches
				0.20	
<b>Reliability</b>					
MTBF	Telcordia SR-332, Method I Case 1 50% electrical stress, 40°C components		5.4		MHrs
<b>EMI and Regulatory Compliance</b>					
Conducted Emissions	MIL-STD-461F C102 with external EMI filter network (see Figures, 34 and 35)				

1. The unit must be properly secured to the interface medium (PCB/Chassis) by use of the threaded inserts of the unit.

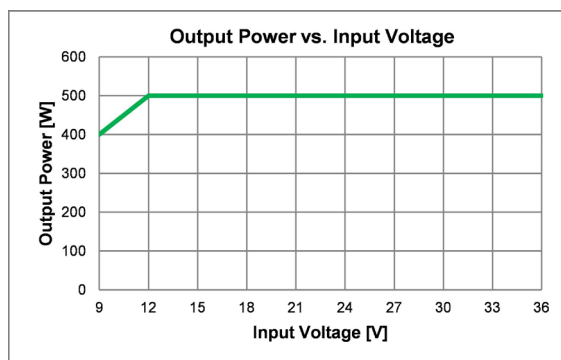

Figure A: Output Power as function of input voltage.

### TECHNICAL NOTES

#### Input and Output Capacitance

In many applications, the inductance associated with the distribution from the power source to the input of the converter can affect the stability of the converter. This becomes of great consideration for input voltage at 12V or below. In order to enable proper operation of the converter, in particular during load transients, an additional input capacitor is required. Minimum required input capacitance, mounted close to the input pins, is 1000µF with ESR < 0.1 Ω. Since inductance of the input power cables could have significant voltage drop due to rate of change of input current  $di(in)/dt$  during transient load operation an external capacitance on the output of the converter is required to reduce  $di(in)/dt$ . It is required to use at least 470 µF (ESR < 0.07Ω) on the output. Another constraint is minimum rms current rating of the input and output capacitors which is application dependent. One component of input rms current handled by input capacitor is high frequency component at switching frequency of the converter (typ. 400kHz) and is specified under "Input terminal ripple current"  $i_c$ . Typical values at full rated load and 24 Vin are provided in Section "Characteristic Waveforms" for each model and are in range of 0.55A - 0.7A. Second component of the ripple current is due to reflected step load current on the input of the converter. Similar consideration needs to be taken into account for output capacitor and in particular step load ripple current component. Consult the factory for further application guidelines.

Additionally, for EMI conducted measurement it is necessary to use 5µH LISNs instead of typical 50µH LISNs.

#### ON/OFF (Pin 3)

The ON/OFF pin is used to turn the power converter on or off remotely via a system signal and has positive logic. A typical connection for remote ON/OFF function is shown in Fig. 1.

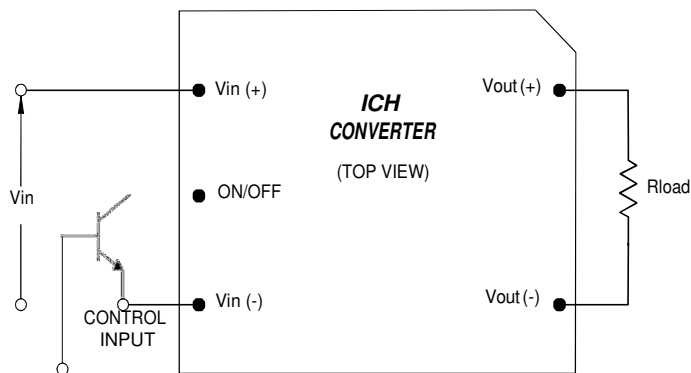

Fig. 1: Circuit configuration for ON/OFF function.

The positive logic version turns on when the ON/OFF pin is at logic high and turns off when at logic low. The converter is on when the ON/OFF pin is either left open, or external voltage not more than 12V is applied between ON/OFF pin and -INPUT pin. See the Electrical Specifications for logic high/low definitions.

The negative logic version turns on when the ON/OFF pin is at logic low and turns off when at logic high. The converter is on when the ON/OFF pin is either shorted to -INPUT pin or kept below 0.8V. The converter is off when the ON/OFF pin is either left open or external voltage greater than 2V and not more than 12V is applied between ON/OFF pin and -INPUT pin. See the Electrical Specifications for logic high/low definitions.

The ON/OFF pin is internally pulled up to typically 4.5V via resistor and connected to internal logic circuit via RC circuit in order to filter out noise that may occur on the ON/OFF pin. A properly de-bounced mechanical switch, open-collector transistor, or FET can be used to drive the input of the ON/OFF pin. The device must be capable of sinking up to 0.36mA at a low level voltage of  $\leq 0.8V$ . During logic high, the typical maximum voltage at ON/OFF pin (generated by the converter) is 4.5V, and the maximum allowable leakage current is 160µA. If not using the remote on/off feature leave the ON/OFF pin open.

TTL Logic Level - The range between 0.81V as maximum turn off voltage and 2V as minimum turn on voltage is considered the dead-band. Operation in the dead-band is not recommended.

External voltage for ON/OFF control should not be applied when there is no input power voltage applied to the converter.

#### Protection Features:

##### Input Undervoltage lockout (UVLO)

Input undervoltage lockout is standard with this converter. The converter will shut down when the input voltage drops below a pre-determined voltage.

The input voltage must be typically above 8.5V for the converter to turn on. Once the converter has been turned on, it will shut off when the input voltage drops typically below 8V. If the converter is started by input voltage (ON/OFF (pin 3) left open) there is typically 500msec delay from the moment when input voltage is above 8.5V turn-on voltage and the time when output voltage starts rising. This delay is intentionally provided to prevent potential startup issues especially at low input voltages.

##### Output Overcurrent Protection (OCP)

The converter is protected against overcurrent or short circuit conditions. Upon sensing an overcurrent condition, the converter will switch to constant current operation and thereby begin to reduce output voltage. When the output voltage drops below approx. 75% of the nominal value of output voltage, the converter will shut down.

Once the converter has shut down, it will attempt to restart nominally every 500msec with a typical 3% duty cycle. The attempted restart will continue indefinitely until the overload or short circuit conditions are removed or the output voltage rises above 75% of its nominal value.



Once the output current is brought back into its specified range, the converter automatically exits the hiccup mode and continues normal operation.

During initial startup, if output voltage does not exceed typical 75% of nominal output voltage within 20 msec after the converter is enabled, the converter will be shut down and will attempt to restart after 500 msec.

### Output Overvoltage Protection (OVP)

The converter will shut down if the output voltage across Vout (+) (Pin 5) and Vout (-) (Pin 9) exceeds the threshold of the OVP circuitry. The OVP circuitry contains its own reference, independent of the output voltage regulation loop. Once the converter has shut down, it will attempt to restart every 500 msec until the OVP condition is removed.

### Overtemperature Protection (OTP)

The ICH converters have non-latching overtemperature protection. It will shut down and disable the output if temperature at the center of the base plate exceeds a threshold of 112°C (typical).

The converter will automatically restart when the base temperature has decreased by approximately 20°C

### Safety Requirements

Basic Insulation is provided between input and the output.

The converters have no internal fuse. To comply with safety agencies requirements, a fast-acting or time-delay fuse is to be provided in the unearthed lead.

Recommended fuse values are:

- a) 60A for 9V < V<sub>in</sub> < 18V.
- b) 30A for 18V < V<sub>in</sub> < 36V.

### Electromagnetic Compatibility (EMC)

EMC requirements must be met at the end-product system level, as no specific standards dedicated to EMC characteristics of board mounted component dc-dc converters exist.

With the addition of a two stage external filter, the ICH converters will pass the requirements of MIL-STD-461F CE102 Base Curve for conducted emissions.

### Absence of the Remote Sense Pins

Customers should be aware that ICH converters do not have a Remote Sense feature. Care should be taken to minimize voltage drop on the user's motherboard as well as if trim function is used.

### Output Voltage Adjust/TRIM (pin7)

The TRIM pin allows user to adjust output voltage 10% up or down relative to rated nominal voltage by addition of external trim resistor. Due to absence of Remote Sense Pins, an external trim resistor should be connected to output pins using Kelvin connection. If trimming is not used, the TRIM pin should be left open.

### Trim Down - Decrease Output Voltage

Trimming down is accomplished by connecting an external resistor, *R<sub>trim-down</sub>*, between the TRIM (pin7) and the Vout(-) (pin 9) using Kelvin connection, with a value of:

$$R_{trim-down} = \left( \frac{3010}{\Delta} - 60.2 \right) [k\Omega]$$

Where,

*R<sub>trim-down</sub>* = Required value of the trim-down resistor [kΩ] V<sub>O(NOM)</sub>  
 = Nominal value of output voltage [V]  
 V<sub>O(req)</sub> = Required value of output voltage [V]

$$\Delta = \left| \frac{V_O(REQ) - V_O(NOM)}{V_O(NOM)} \right| [\%]$$

To trim the output voltage 10% (Δ=10) down, required external trim resistance is:

$$R_{trim-down} = \left( \frac{3010}{10} - 60.2 \right) = 240.8 [k\Omega]$$

### Trim Up - Increase Output Voltage

Trimming up is accomplished by connecting an external resistor, *R<sub>trim-up</sub>*, between the TRIM (pin 7) and the Vout(+) (pin 5) using Kelvin connection, with a value of:

$$R_{trim-up} = 30.1 * \left\{ \left[ \frac{V_O(NOM) * (100 + \Delta)}{1.225\Delta} \right] - \frac{(100 + 2\Delta)}{\Delta} \right\} [k\Omega]$$

To trim the output voltage up, for example 24V to 26.4V, Δ=10 and required external resistor is:

$$R_{trim-up} = 30.1 * \left\{ \left[ \frac{24 * (100 + 10)}{1.225 * 10} \right] - \frac{(100 + 2 * 10)}{10} \right\} = 6125 [k\Omega]$$

Note that trimming output voltage more than 10% is not recommended and OVP may be tripped.

### Active Voltage Programming

In applications where output voltage needs to be adjusted actively, an external voltage source, such as for example a Digital-to-Analog converter (DAC), capable of both sourcing and sinking current can be used. It should be connected with series resistor R<sub>g</sub> across TRIM (pin 7) and Vout (-) (pin 9) using Kelvin connection. Please contact Murata technical representative for more details.





## Characteristic Curves - Efficiency and Power Dissipation

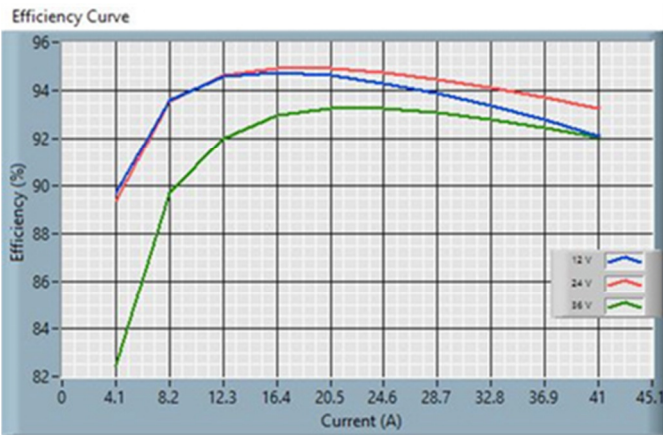

Fig. 4: ICH0141V1PC Efficiency Curve

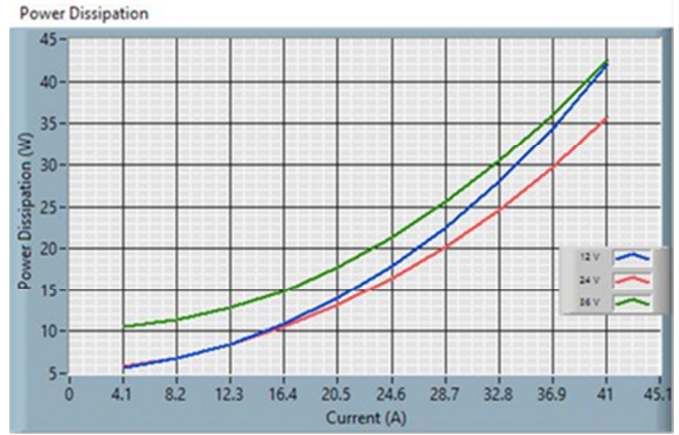

Fig. 5: ICH0141V1PC Power Dissipation

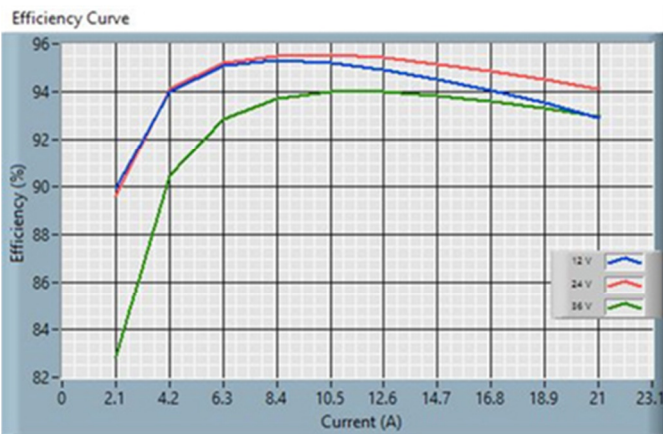

Fig. 6: ICH0421V1PC Efficiency Curve

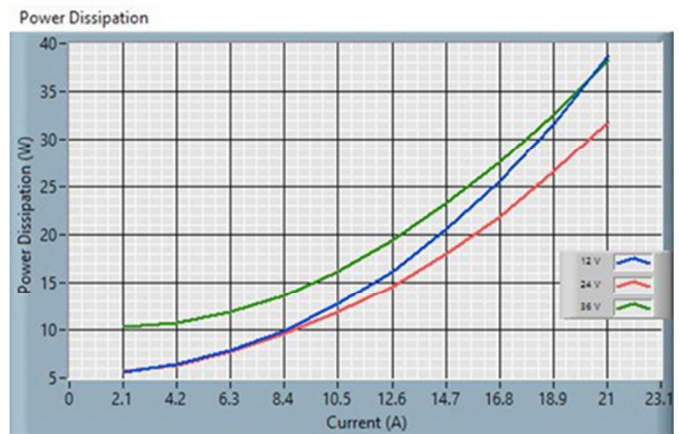

Fig. 7: ICH0421V1PC Power Dissipation

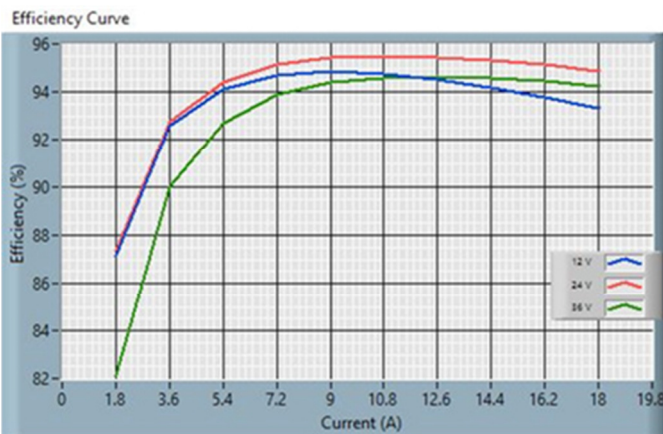

Fig. 8: ICH0518V1PC Efficiency Curve

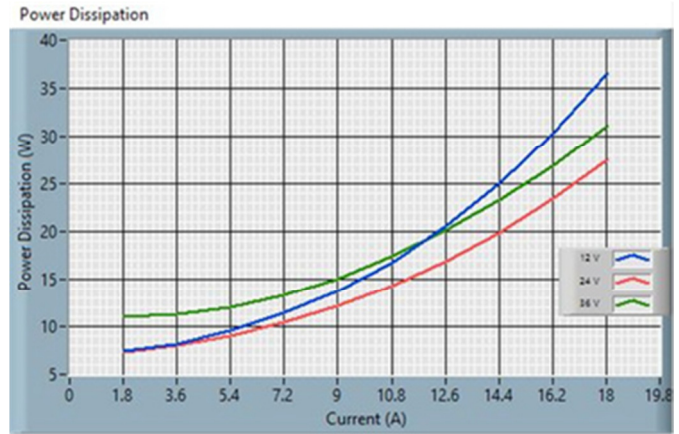

Fig. 9: ICH0518V1PC Power Dissipation

**Characteristic Curves – Derating Curves**

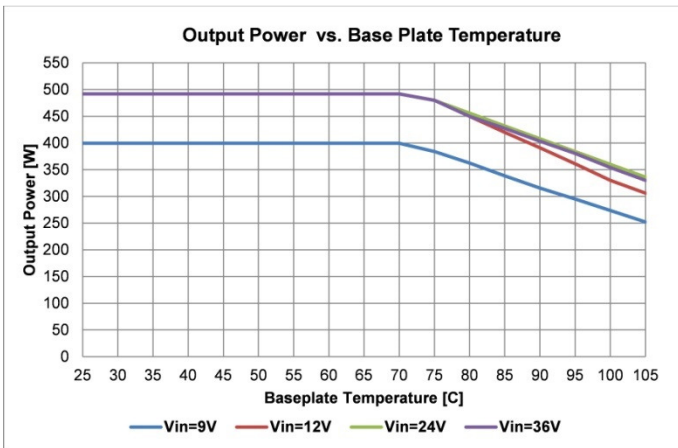

Fig. 10: ICH0141V1PC Derating Curve (P<sub>out</sub>)

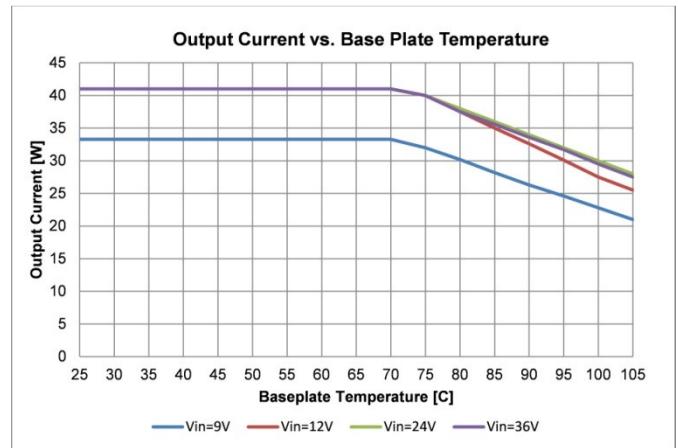

Fig. 11: ICH0141V1PC Derating Curve (I<sub>out</sub>)

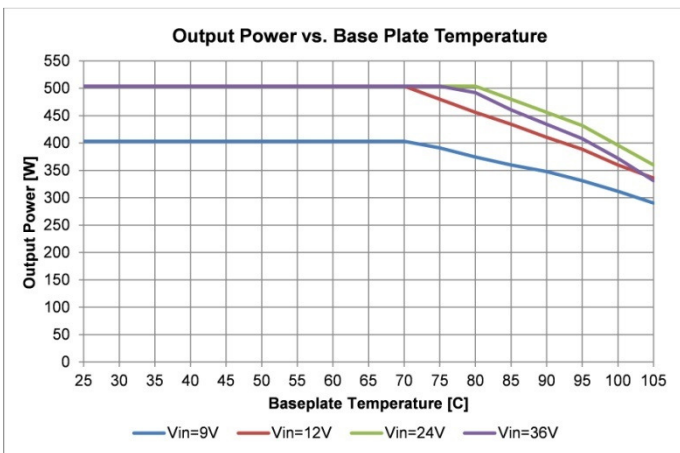

Fig. 12: ICH0421V1PC Derating Curve (P<sub>out</sub>)

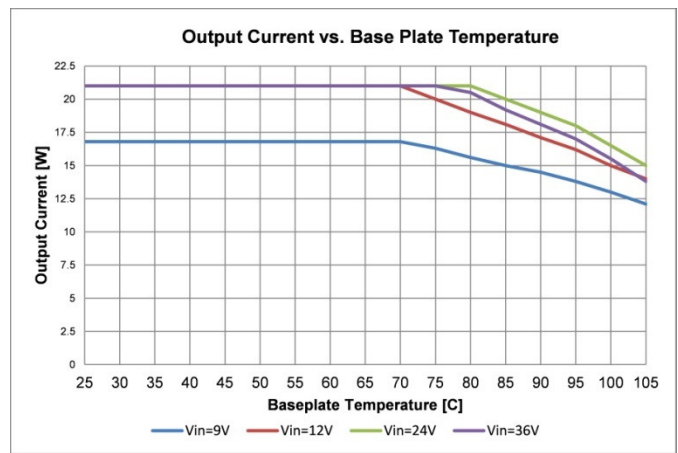

Fig. 13: ICH0421V1PC Derating Curve (I<sub>out</sub>)

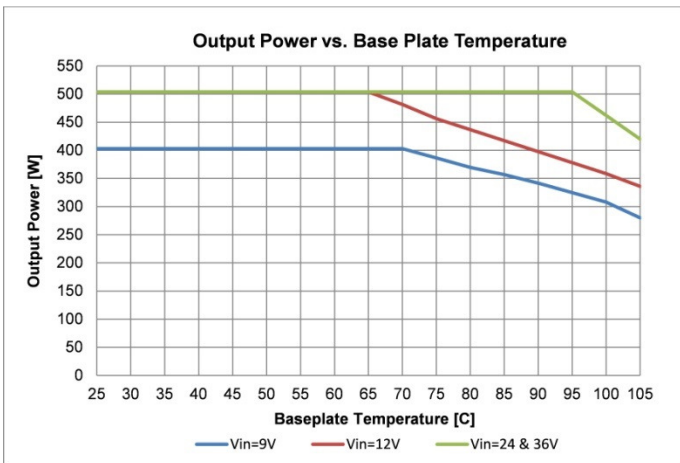

Fig. 14: ICH0518V1PC Derating Curve (P<sub>out</sub>)

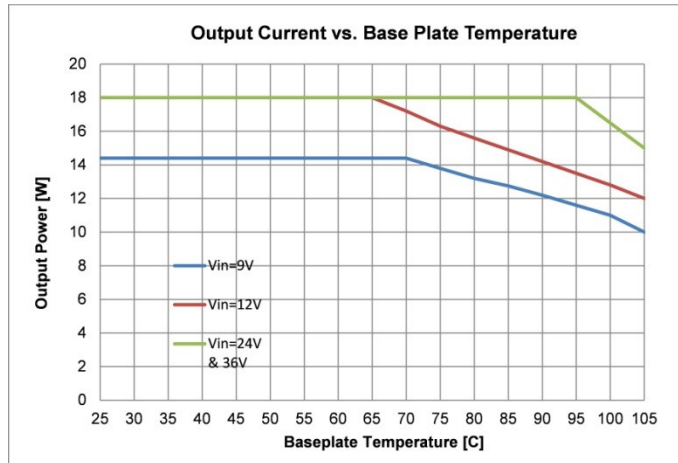

Fig. 15: ICH0518V1PC Derating Curve (I<sub>out</sub>)



## Characteristic Waveforms - ICH0141V1PC

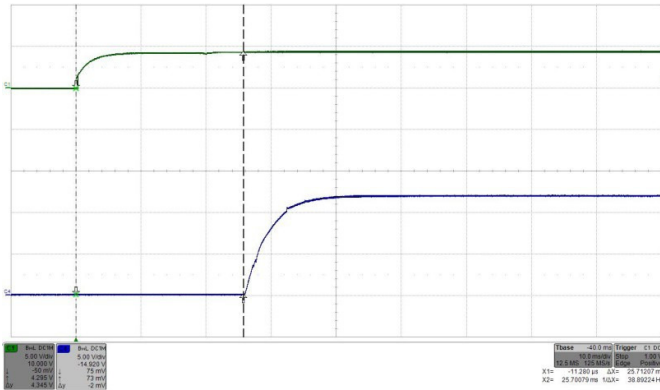

Fig. 16: Turn-on by ON/OFF transient (with  $V_{in}$  applied) at full rated load current (resistive) at  $V_{in} = 24V$ . Top trace (C1): ON/OFF signal (5 V/div.). Bottom trace (C4): Output voltage (5 V/div.). Time: 5 ms/div.

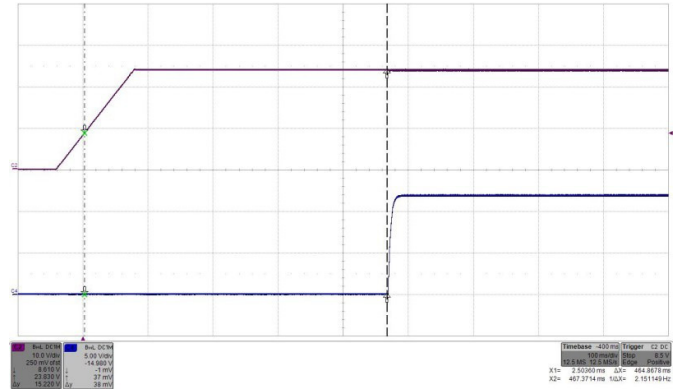

Fig. 17: Turn-on by  $V_{in}$  (ON/OFF high) transient at full rated load current (resistive) at  $V_{in} = 24V$ . Top trace (C2): Input voltage  $V_{in}$  (10 V/div.). Bottom trace (C4): Output voltage (5 V/div.). Time: 100 ms/div.

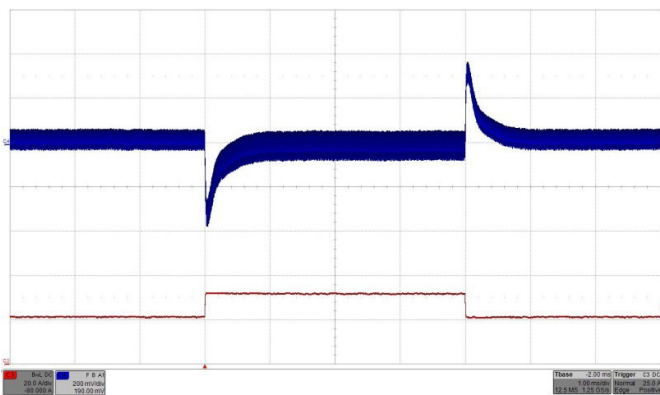

Fig. 18: Output voltage response to load current step change 50% - 75% - 50% (20.5A-31.5A-20.5A) with  $di/dt = 1A/\mu s$  at  $V_{in} = 24V$ . Top trace (C4): Output voltage (200 mV/div.). Bottom trace (C3): Load current (20A/div.).  $C_o = 470 \mu F/70m\Omega$ . Time: 1ms/div.

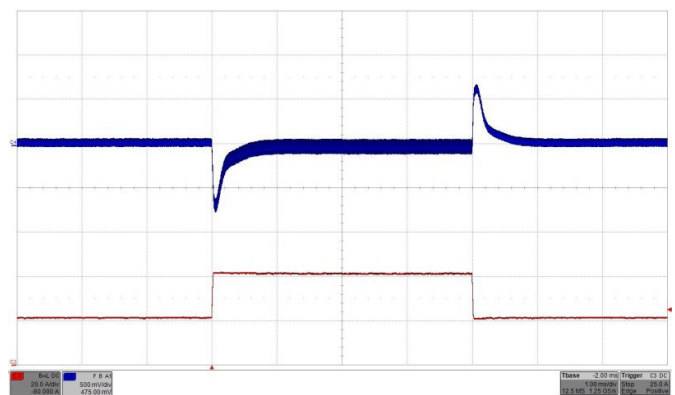

Fig. 19: Output voltage response to load current step change 50% - 100% - 50% (20.5A-41A-20.5A) with  $di/dt = 1A/\mu s$  at  $V_{in} = 24V$ . Top trace (C4): Output voltage (500 mV/div.). Bottom trace (C3): Load current (20A/div.).  $C_o = 470 \mu F/70m\Omega$ . Time: 1ms/div.

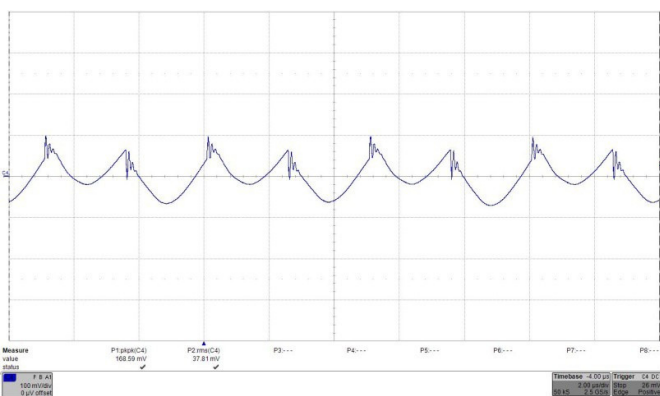

Fig. 20: Output voltage ripple (100 mV/div.) at full rated load current into a resistive load at  $V_{in} = 24V$ .  $C_o = 470 \mu F/70m\Omega$ . Time: 2  $\mu s$ /div.

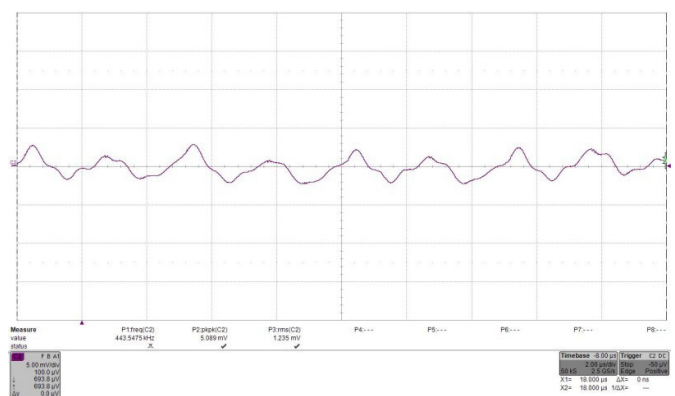

Fig. 21: Input reflected ripple current,  $i_c$  (500 mA/mV), measured at input terminals at full rated load current at  $V_{in} = 24V$ . Refer to Fig. 2 for test setup. Time: 2  $\mu s$ /div. RMS input ripple current is  $1.235 \times 500mA = 617.5mA$ .

## Characteristic Waveforms - ICH0421V1PC

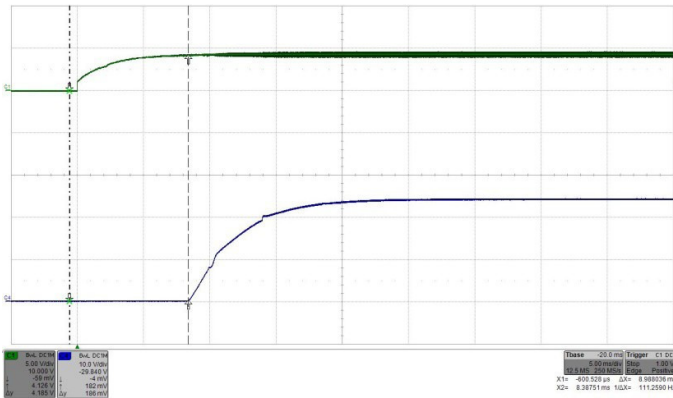

Fig. 22: Turn-on by ON/OFF transient (with Vin applied) at full rated load current (resistive) at Vin = 24V. Top trace (C1): ON/OFF signal (5 V/div.). Bottom trace (C4): Output voltage (10 V/div.). Time: 5 ms/div.

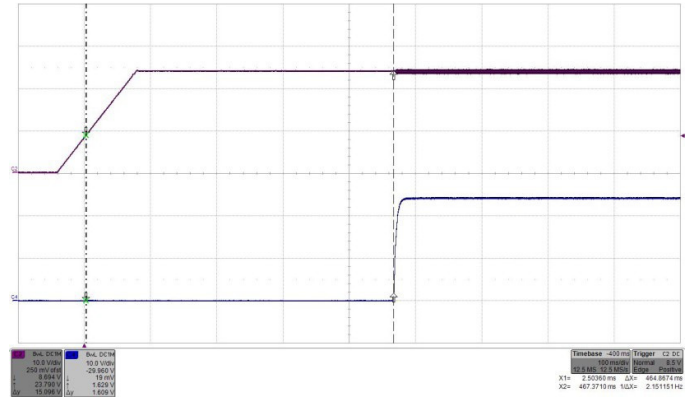

Fig. 23: Turn-on by Vin transient (ON/OFF high) at full rated load current (resistive) at Vin = 24V. Top trace (C2): Input voltage Vin (10 V/div.). Bottom trace (C4): Output voltage (10 V/div.). Time: 100 ms/div.

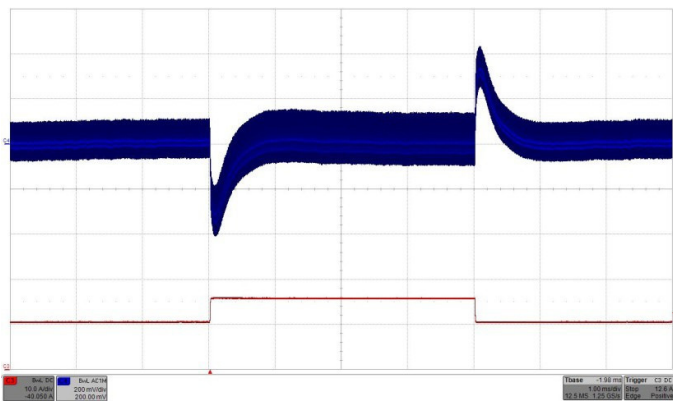

Fig. 24: Output voltage response to load current step change 50% - 75% - 50% (10.5A-15.75A-10.5A) with di/dt = 1A/μs at Vin = 24V. Top trace (C4): Output voltage (200 mV/div.). Bottom trace (C3): Load current (10A/div.). Co = 470 μF/70mΩ. Time: 1ms/div.

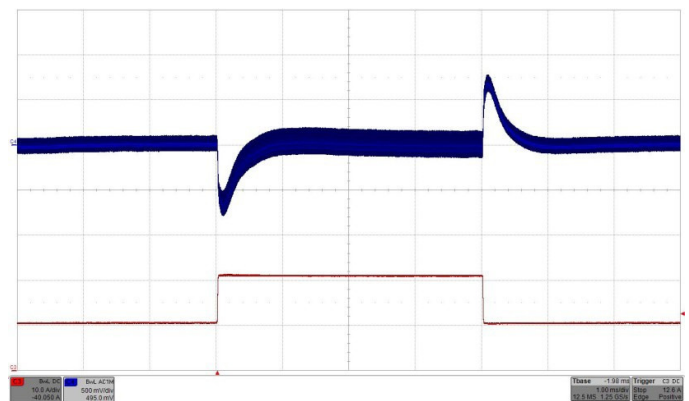

Fig. 25: Output voltage response to load current step change 50% - 100% - 50% (10.5A-21A-10.5A) with di/dt = 1A/μs at Vin = 24V. Top trace (C4): Output voltage (500 mV/div.). Bottom trace (C3): Load current (10 A/div.). Co = 470 μF/70mΩ. Time: 1ms/div.

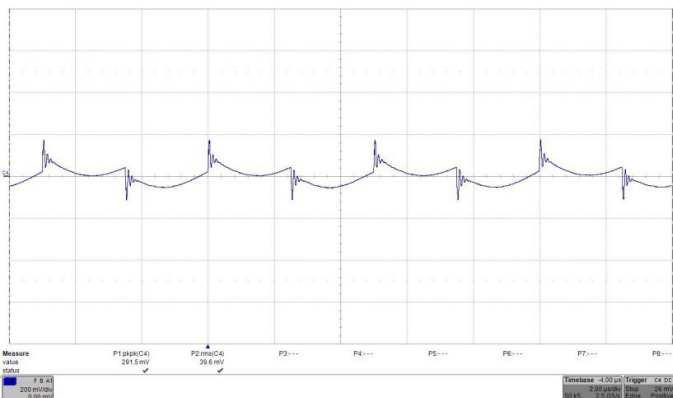

Fig. 26: Output voltage ripple (200 mV/div.) at full rated load current into a resistive load at Vin = 24V. Co= 470 μF/70mΩ. Time: 2 μs/div.

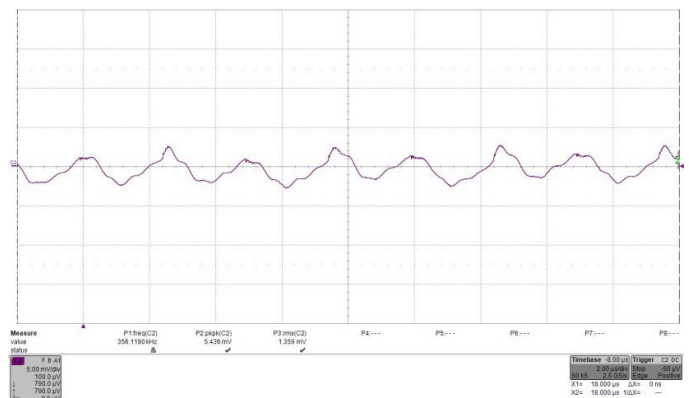

Fig. 27: Input reflected ripple current, ic (500 mA/mV), measured at input terminals at full rated load current at Vin = 24V. Refer to Fig. 2 for test setup. Time: 2 μs/div. RMS input ripple current is 1.359\*500mA = 679.5mA.

**Characteristic Waveforms - ICH0518V1PC**

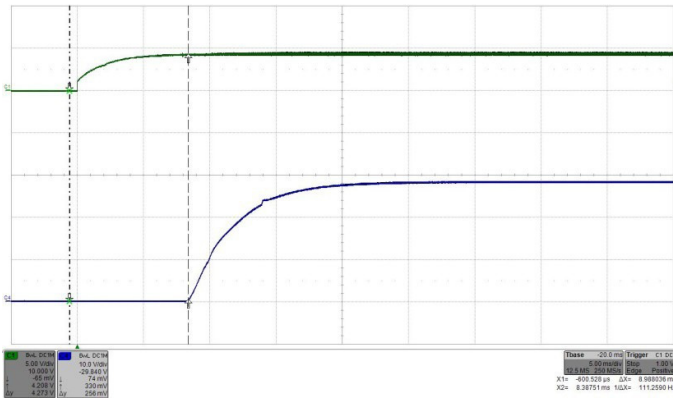

Fig. 28: Turn-on by ON/OFF transient (with  $V_{in}$  applied) at full rated load current (resistive) at  $V_{in} = 24V$ . Top trace (C1): ON/OFF signal (5 V/div.). Bottom trace (C4): Output voltage (10 V/div.). Time: 5 ms/div.

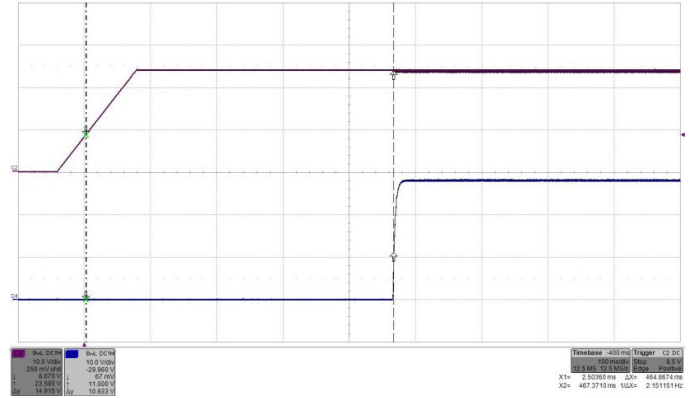

Fig. 29: Turn-on by  $V_{in}$  transient (ON/OFF high) at full rated load current (resistive) at  $V_{in} = 24V$ . Top trace (C2): Input voltage  $V_{in}$  (10 V/div.). Bottom trace (C4): Output voltage (10 V/div.). Time: 100 ms/div.

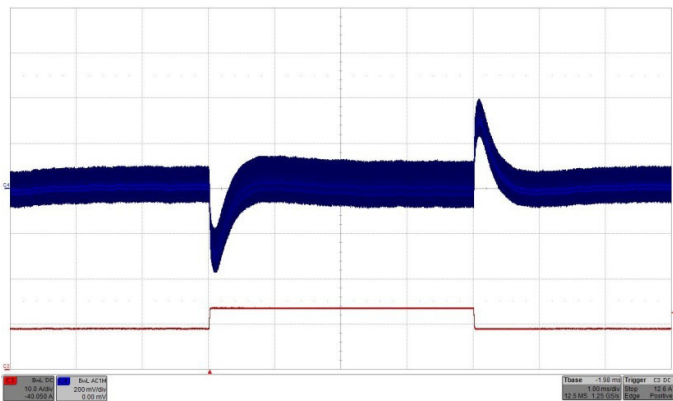

Fig. 30: Output voltage response to load current step change 50% - 75% - 50% (9A-13.5A-9A) with  $di/dt = 1A/\mu s$  at  $V_{in} = 24V$ . Top trace (C4): Output voltage (200 mV/div.). Bottom trace (C3): Load current (10A/div.).  $C_o = 470\mu f/70m\Omega$ . Time: 1ms/div.

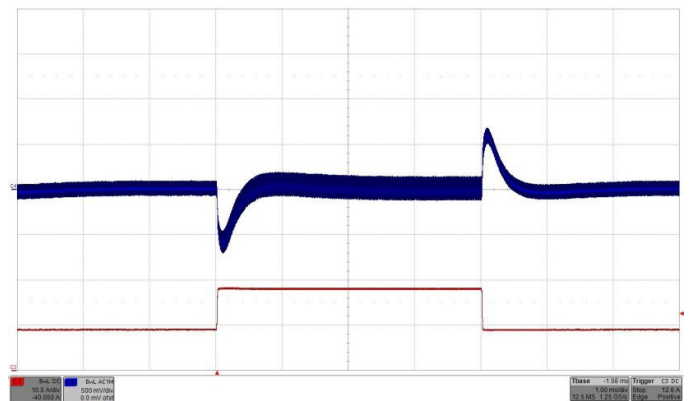

Fig. 31: Output voltage response to load current step change 50% - 100% - 50% (9A-18A-9A) with  $di/dt = 1A/\mu s$  at  $V_{in} = 24V$ . Top trace (C4): Output voltage (500 mV/div.). Bottom trace (C3): Load current (10A/div.).  $C_o = 470\mu f/70m\Omega$ . Time: 1ms/div.

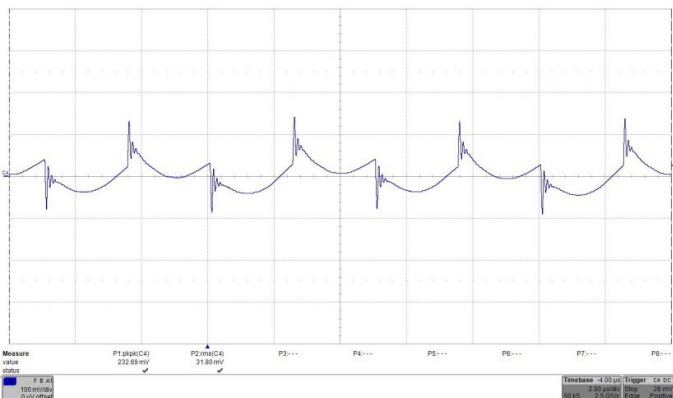

Fig. 32: Output voltage ripple (200mV/div.) at full rated load current into a resistive load at  $V_{in} = 24V$ .  $C_o = 470 \mu F/70m\Omega$ . Time: 2  $\mu s$ /div.

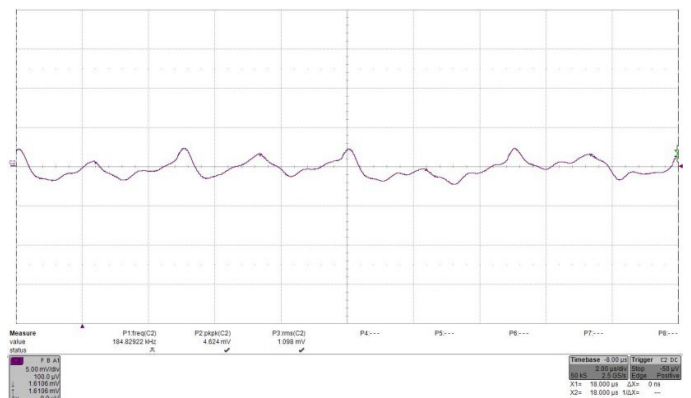

Fig. 33: Input reflected ripple current,  $i_c$  (500mA/mV), measured at input terminals at full rated load current at  $V_{in} = 24V$ . Refer to Fig. 2 for test setup. Time: 2 $\mu s$ /div. RMS input ripple current is 1.098\*500mA = 549mA.



**EMC Consideration:**

The filter schematic for suggested input filter configuration as tested to meet the conducted emission limits of MIL-STD 461F CE102 Base Curve is shown in Fig. 34. The plots of conducted EMI spectrum are shown in Fig. 35.

Note: Customer is ultimately responsible for the proper selection, component rating and verification of the suggested parts based on the end application.

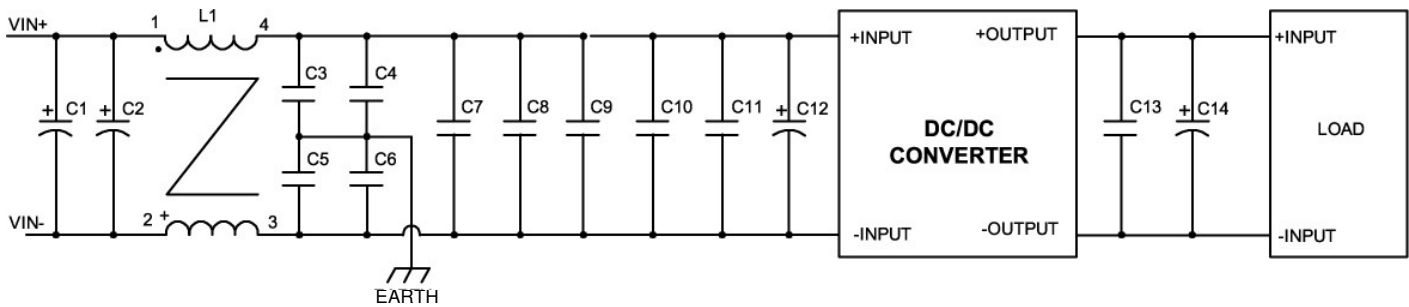

Comp. Des.	Description
C1, C2, C12, C14	470μF/50V/70mΩ Electrolytic Capacitor (Vishay MAL214699108E3 or equivalent)
C3, C4, C5, C6	4.7nF/1210/X7R/1500V Ceramic Capacitor
C7, C8, C9, C10, C11, C13	10μF/1210/X7R/50V Ceramic Capacitor
L1	CM choke: L = 130μH, L <sub>lkg</sub> = 0.6μH (4 turns on toroid 22.1mm x 13.7mm x 7.92mm)

Fig. 34: Typical input EMI filter circuit to attenuate conducted emissions per MIL-STD-461F CE102 Base Curve.

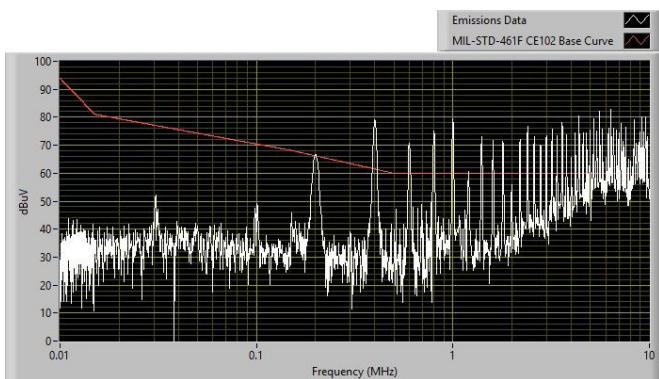

a) Without input filter. C<sub>IN</sub> = 2 x 470μF/50V/70mΩ.

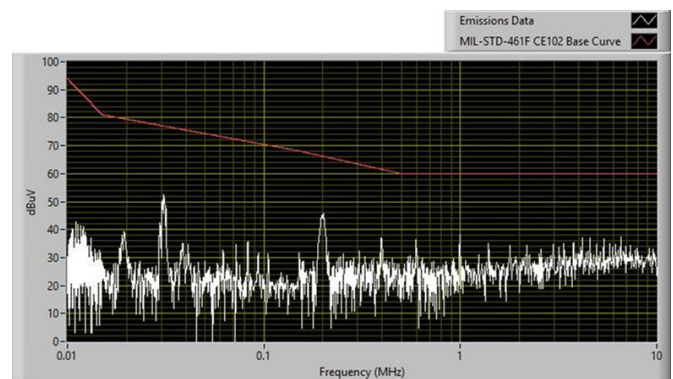

b) With input filter from Fig. 34.

Fig.35: Input conducted emissions measurement (Typ.) of ICH0421V1PC

**Mechanical Specifications:**

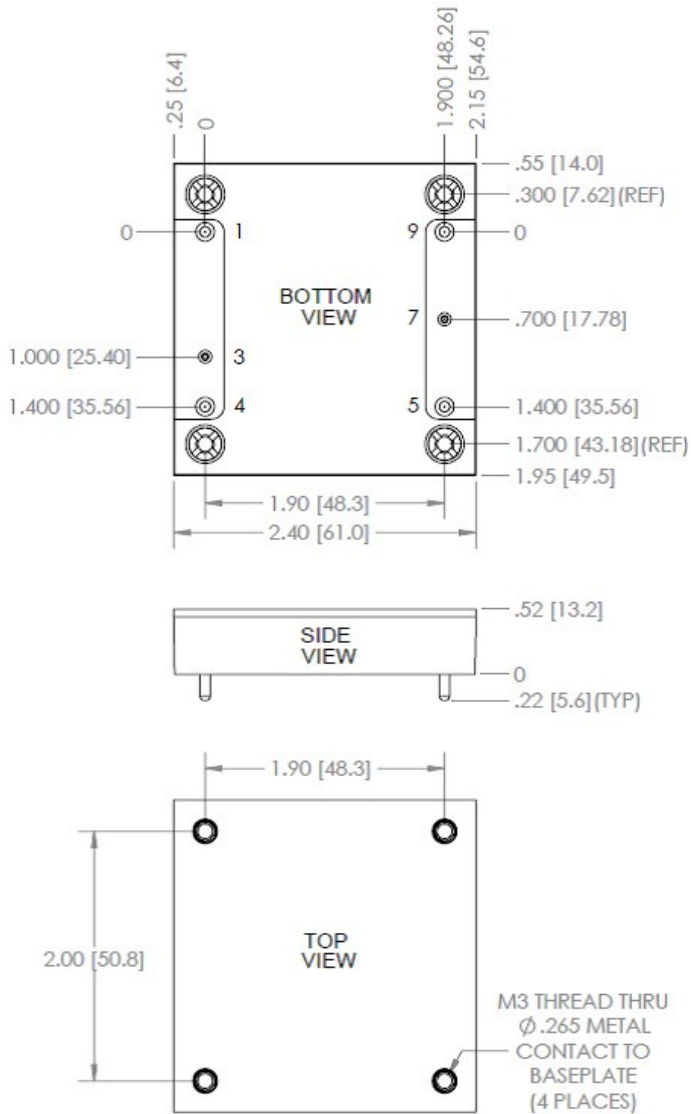

**NOTES:**

Unless otherwise specified:

All dimensions are in inches [millimeters]

Tolerances: x.xx in.  $\pm 0.02$  in. [x.x mm  $\pm 0.5$ mm]

x.xxx in.  $\pm 0.010$  in [x.xx mm  $\pm 0.25$ mm]

Torque fasteners into threaded mounting inserts at 10in.lbs. or less. Greater torque may result in damage to unit and void the warranty.

**Input/Output Connections:**

Pin	Name	Function
1	-INPUT	Negative input voltage
3	ON/OFF	TTL input with internal pull up, referenced to -INPUT, used to turn converter on and off
4	+INPUT	Positive input voltage
5	+OUTPUT	Positive output voltage
7	TRIM	Output voltage trim
9	- OUTPUT	Negative output voltage

**Notes:**

1) Pinout is inconsistent between manufacturers of the half brick converters. Make sure to follow the pin function and the pin number, when laying out your board.

2) Pin diameter for the input pins of the ICH converters has diameter 0.081" due to high input current at low line, and is different from other manufacturers of the half brick. Make sure to follow pin dimensions in your application.

**Packaging Information:**

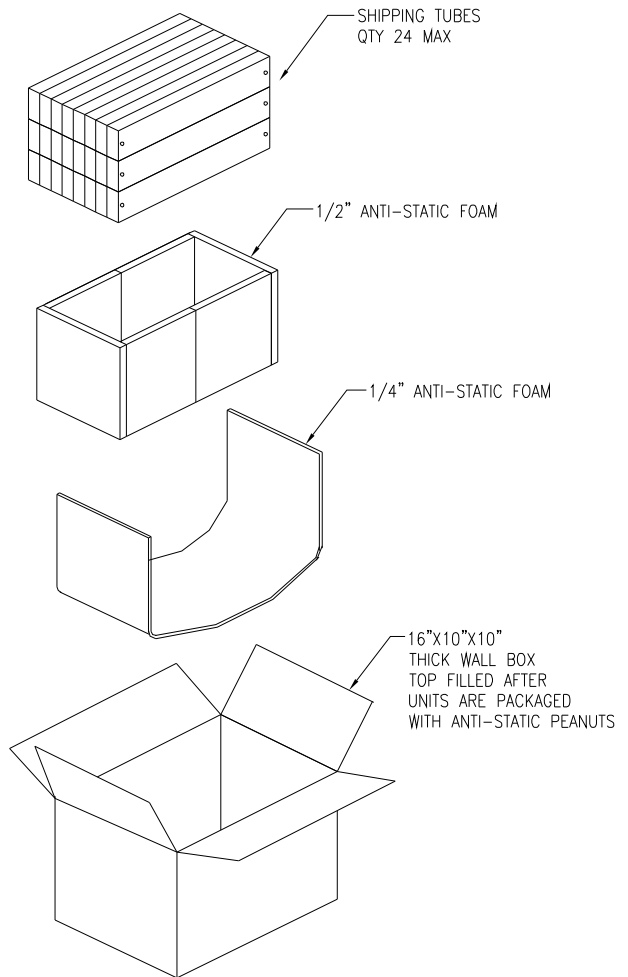
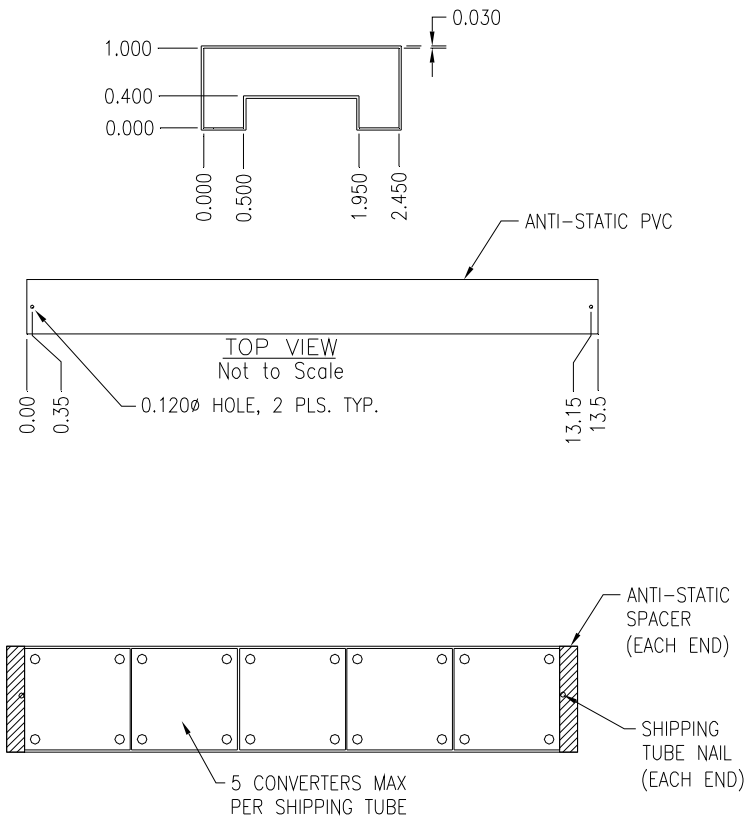

1. SHIPPING TUBE MATERIAL: ANTI-STATIC PVC
2. ALL END VIEW DIMENSIONS ARE INSIDE DIMENSIONS.
3. ALL DIMENSIONS ARE  $\pm 0.010$ ".
4. CARDBOARD SHIPPING BOX IS 16" X 10" X 10"
5. MAXIMUM NUMBER OF UNITS (MPQ) PER BOX IS 120 CONVERTERS.
6. BOX IS TOP FILLED WITH ANTI-STATIC SHIPPING PEANUTS

Murata Power Solutions, Inc.  
 129 Flanders Road, Westborough MA 01581 U.S.A.  
 ISO 9001 and 14001 REGISTERED



**This product is subject to the following operating requirements and the Life and Safety Critical Application Sales Policy:**

Refer to: <http://www.murata-ps.com/requirements/>

Murata Power Solutions, Inc. makes no representation that the use of its products in the circuits described herein, or the use of other technical information contained herein, will not infringe upon existing or future patent rights. The descriptions contained herein do not imply the granting of licenses to make, use, or sell equipment constructed in accordance therewith. Specifications are subject to change without notice. © 2018 Murata Power Solutions, Inc.