

STRADA-B2

Wide oval beam for area lighting optimized for CREE XT-E. Assembly with installation tape.

TECHNICAL SPECIFICATIONS:

Dimensions	19.6 x 15.5 mm
Height	5.2 mm
Fastening	tape, pin
ROHS compliant	yes ⓘ



MATERIAL SPECIFICATIONS:

Component	Type	Material	Colour	Finish
STRADA-B2	Single lens	PMMA	clear	
VOSU-WU-M-365-TAPE	Tape			

ORDERING INFORMATION:

Component	Type	Qty in box	MOQ	MPQ	Box weight (kg)
CA13473_STRADA-B2 » Box size: 451 x 254 x 197 mm	Single lens	4320	240	240	4.0

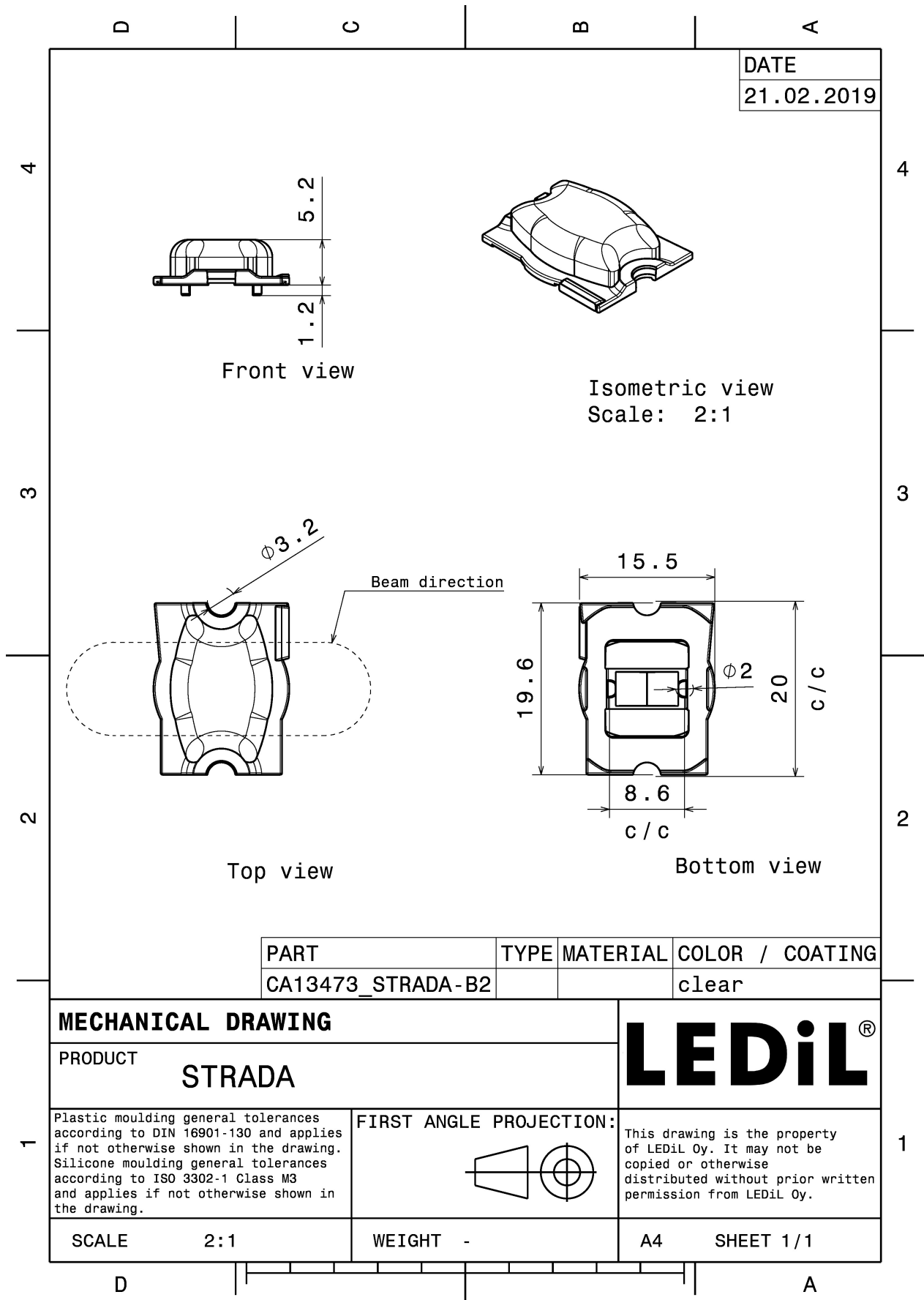

PART	TYPE	MATERIAL	COLOR / COATING
CA13473_STRADA-B2			clear

MECHANICAL DRAWING		LEDiL®
PRODUCT STRADA		
Plastic moulding general tolerances according to DIN 16901-130 and applies if not otherwise shown in the drawing. Silicone moulding general tolerances according to ISO 3302-1 Class M3 and applies if not otherwise shown in the drawing.	FIRST ANGLE PROJECTION: 	This drawing is the property of LEDiL Oy. It may not be copied or otherwise distributed without prior written permission from LEDiL Oy.
SCALE 2:1	WEIGHT -	A4 SHEET 1/1

See also our general installation guide: www.ledil.com/installation_guide

PHOTOMETRIC DATA (MEASURED):

CREE

LED XT-E
FWHM / FWTM 119.0 + 40.0°
Efficiency 94 %
Peak intensity 0.6 cd/lm
LEDs/each optic 1
Light colour White
Required components:

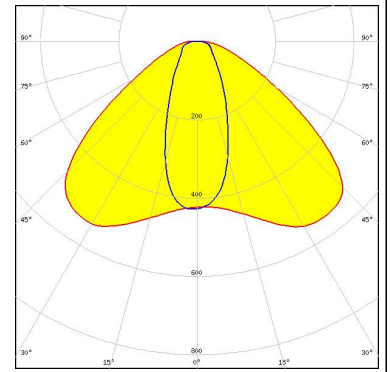

NICHIA

LED NVSW319B
FWHM / FWTM Asymmetric
Efficiency 88 %
Peak intensity 0.5 cd/lm
LEDs/each optic 1
Light colour White
Required components:

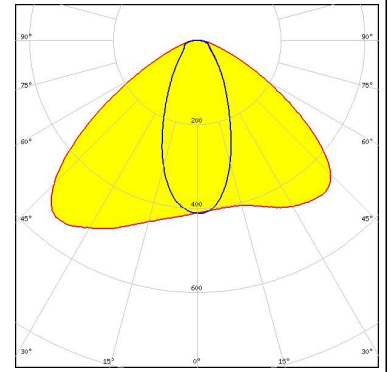

SAMSUNG

LED LH351Z
FWHM / FWTM 116.0 + 42.0°
Efficiency 89 %
Peak intensity 0.6 cd/lm
LEDs/each optic 1
Light colour White
Required components:

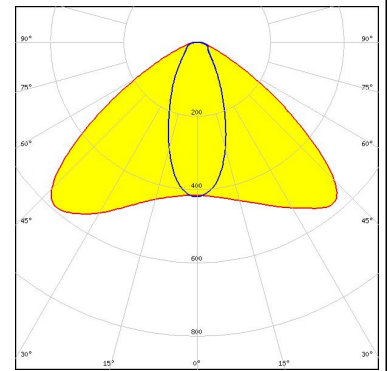

PHOTOMETRIC DATA (SIMULATED):

CREE 

LED XP-G2
FWHM / FWTM Asymmetric
Efficiency 94 %
Peak intensity 0.8 cd/lm
LEDs/each optic 1
Light colour White
Required components:

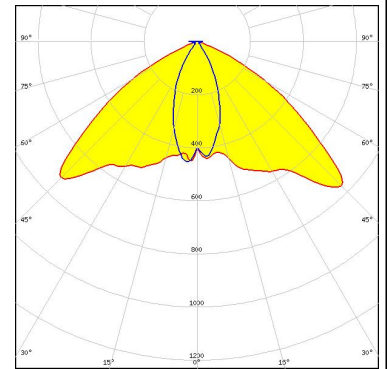

OSRAM
Opto Semiconductors

LED OSCONIQ P 3737 (3W version)
FWHM / FWTM Asymmetric
Efficiency 94 %
Peak intensity 0.7 cd/lm
LEDs/each optic 1
Light colour White
Required components:

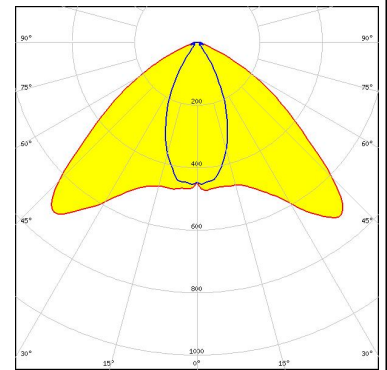

SAMSUNG

LED LH351B
FWHM / FWTM Asymmetric
Efficiency 92 %
Peak intensity 0.7 cd/lm
LEDs/each optic 1
Light colour White
Required components:

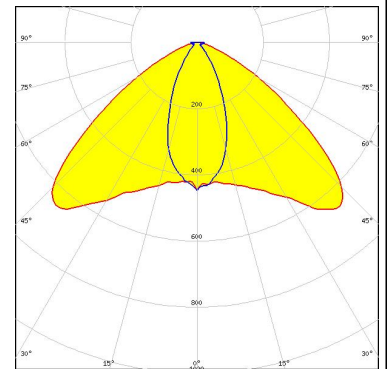

GENERAL INFORMATION:

NOTE: The typical beam angle will be changed by different color, chip size and chip position tolerance. The typical total beam angle is the full angle measured where the luminous intensity is half of the peak value.

MATERIALS:

As part of our continuous research and improvement processes, and to ensure the best possible quality and availability of our products, LEDiL reserves the right to change material grades without notice.

PRODUCT DATA USER AGREEMENT AND DISCLAIMER:

The measured data in the provided downloadable LEDiL Product Datasheets and Mechanical 2D-Drawings is rounded and provided as reference for planning. LEDiL Oy's optical specifications have been verified by conducting performance testing of the products in accordance with the company's quality system. The reported data are averaged results of multiple measurements with typical variation. LEDiL Oy reserves the right to without prior notification make changes and improvements to its products.

LEDiL Oy assumes neither warranty, nor guarantee nor any other liability of any kind for the contents and correctness of the provided data. The provided data has been generated with highest diligence but the provided data may in reality not represent the complete possible variation range of all intrinsic parameters. Therefore, in certain cases a deviation from the provided data could occur.

LEDiL Oy reserves the right to undertake technical changes of its products without further notification which could lead to changes in the provided data. LEDiL Oy assumes no liability of any kind for the possible deviation from any provided data or any other damage resulting from the usage of the provided data.

The user agrees to this disclaimer and user agreement with the download or usage of the provided files.

LEDiL Oy

Joensuunkatu 13
FI-24240 SALO
Finland

LEDiL Inc.

228 West Page Street
Suite D
Sycamore IL 60178
USA

Ledil Optics Technology (Shenzhen) Co., Ltd.

405 , Block B
Casic Motor Building
Shenzhen 518057
P.R.CHINA

Local sales and technical support

[www.ledil.com/
where_to_buy](http://www.ledil.com/where_to_buy)

Shipping locations

Salo, Finland
Hong Kong, China

Distribution Partners

[www.ledil.com/
where_to_buy](http://www.ledil.com/where_to_buy)