

CMOS LDO Regulator for Portable Equipments

Dual, Low-Dropout Linear Regulator



BD7003NUX, BD7004NUX

No.12020ECT09

●Descriptions

The BD7003NUX, BD7004NUX are dual channels, 300mA low-dropout voltage regulator output at each channel. The output voltage range is from 1.2V to 3.3V by operating range from 2.5V to 5.5V. The output voltages, VOUT1 and VOUT2, are determined at power up by the state of P1 and P2(see the table of "Output-Voltage Programming"). The BD7003NUX, BD7004NUX offer 1.8% accuracy and low-dropout. The shutdown current is near the zero current which is suitable for battery powered device. The BD7003NUX, BD7004NUX are mounted on VSON008X2020(2.0mmX2.0mmX0.6mm), which contributes to the space-saving design of set.

●Features

- 1) 2-channel 300mA, CMOS-type LDOs.
- 2) Pin-Programmable Output Voltage.
(9 steps adjustable VO ; See the Table of "Output-Voltage Programming".)
- 3) LDOs Power ON/OFF Enable Control.
- 4) 2.0mm × 2.0mm Package.
- 5) Small Ceramic Output Capacitors(1 μ F).
- 6) Equipped with Over Current Limiter and Thermal Shutdown Circuit(TSD) .

●Applications

Battery-powered portable equipment, etc.

●Absolute Maximum Ratings (Ta = 25°C)

Parameter	Symbol	Ratings	Unit
Maximum Supply Voltage (VIN)	VIN	-0.3 ~ 7	V
Maximum Input Voltage 1 (P1,P2,EN1,EN2)	VINMAX1	-0.3 ~ 7	V
Maximum Input Voltage 2 (Vout1,Vout2)	VINMAX2	-0.3~Vin+0.3	V
Power Dissipation	Pd	1360* ¹	mW
Operating Temperature Range	Topr	-40 ~ +85	°C
Storage Temperature Range	Tstg	-55 ~ +150	°C

*¹ This is the allowable loss of when it is mounted on a ROHM specification board 40mm × 40mm × 1.5mm
To use at temperature higher than 25°C , derate 10.9mW per 1°C

* This product is not especially designed to be protected from radioactivity.

●Recommended Operating Range (Ta=-40~+85°C)

Parameter	Symbol	Ratings	Unit
Input Power Supply Voltage Range	VIN	2.5~5.5	V

● Power Dissipation



As for power dissipation, an approximate estimate of the heat reduction characteristics and internal power consumption of IC are shown, so please use these for reference. Since power dissipation changes substantially depending on the implementation conditions (board size, board thickness, metal wiring rate, number of layers and through holes, etc.), it is recommended to measure Pd on a set board. Exceeding the power dissipation of IC may lead to deterioration of the original IC performance, such as causing operation of the thermal shutdown circuit or reduction in current capability. Therefore, be sure to prepare sufficient margin within power dissipation for usage.

Calculation of the maximum internal power consumption of IC (P_{MAX})

$$P_{MAX} = (V_{IN} - V_{OUT}) \times I_{OUT(MAX)}$$

(V_{IN}: Input voltage V_{OUT}: Output voltage I_{OUT(MAX)}: Maximum output current)

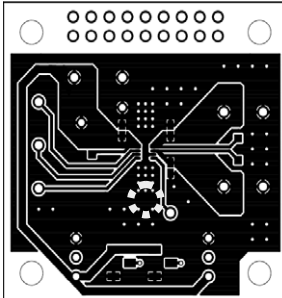
Measurement conditions

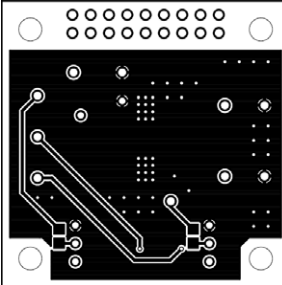
	Evaluation Board 1 (Double-side Board)
Layout of Board for Measurement (Unit: mm)	 <p>Top Layer (Top View)</p>
 IC Implementation Position	 <p>Bottom Layer (Top View)</p>
Power Dissipation	1.36W
Thermal Resistance	θ _{ja} =91.9°C/W

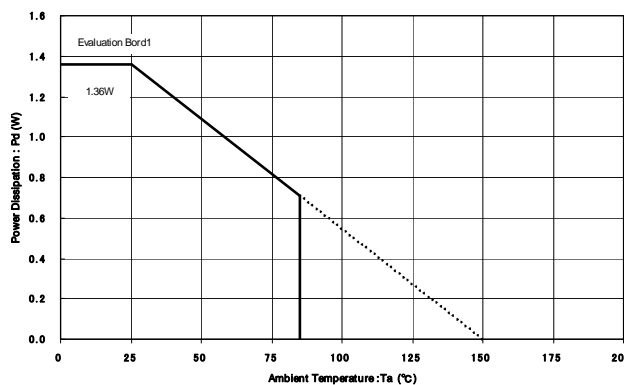

Fig.1. VSON008X2020 Power dissipation heat reduction characteristics (Reference)

* Please design the margin so that P_{MAX} becomes is than Pd (P_{MAX}<Pd) within the usage temperature range.

● **Electrical Characteristics** ($V_{in}=3.7V$, $EN1=EN2=V_{in}$, $T_a = +25^{\circ}C$, unless otherwise noted.)

Parameter	Symbol	Limits			Unit	Condition
		Min	Typ	Max		
Output Voltage range	VOUT	1.2	-	3.3	V	
Input Voltage range	VIN	2.5	-	5.5	V	
Output Voltage Accuracy	Δv_{outa}	-1.8	-	1.8	%	$I_{out}=1mA$, $V_{OUT} \geq 1.5V$
	Δv_{outb}	-30	-	+30	mV	$I_{out}=1mA$, $V_{OUT}=1.2V$
Maximum Output Current	I_{max}	300	-	-	mA	
Short Circuit Current	I_{sc}	-	150	-	mA	$V_{OUT} = 0V$
Ground Pin Current	I_q	-	55	95	μA	$I_{out}=0mA$
		-	35	65		One LDO shutdown, $I_{out}=0mA$
Dropout Voltage	Vdrop	-	120	170	mV	$V_{IN}=2.5V$, $V_{OUT}=2.6V$, $I_{out}=100mA$
		-	90	140		$V_{IN}=2.7V$, $V_{OUT}=2.8V$, $I_{out}=100mA$
		-	80	130		$V_{IN}=2.9V$, $V_{OUT}=3.0V$, $I_{out}=100mA$
		-	70	120		$V_{IN}=3.2V$, $V_{OUT}=3.3V$, $I_{out}=100mA$
		-	360	510		$V_{IN}=2.5V$, $V_{OUT}=2.6V$, $I_{out}=300mA$
		-	270	420		$V_{IN}=2.7V$, $V_{OUT}=2.8V$, $I_{out}=300mA$
		-	240	390		$V_{IN}=2.9V$, $V_{OUT}=3.0V$, $I_{out}=300mA$
		-	210	360		$V_{IN}=3.2V$, $V_{OUT}=3.3V$, $I_{out}=300mA$
Line Regulation	ΔV_{LNR}	-	0.02	0.2	%/V	$V_{IN}=V_{OUT}+1V$ to $V_{IN}=5.5V$, $I_{out}=10mA$
Load Regulation	ΔV_{LDR}	-	0.2	0.6	%	$I_{out}=1mA$ to $300mA$
Ripple Rejection	PSRR	-	66	-	dB	$f=100Hz$, $I_{out}=10mA$ @ $V_{OUT}=1.5V$
Output Noise	e_n	-	150	-	μV_{rms}	$f_{BW}=10Hz$ to $100kHz$; $I_{out}=10mA$
● EN1, EN2						
Enable Input Threshold	V_{iH}	1.2	-	-	V	Regulator enabled
	V_{iL}	-	-	0.5		Regulator shutdown
Enable Input Leakage Current	I_{en}	-	0.1	1	μA	$V_{en}=V_{IN}$, $T_a = +25^{\circ}C$
Shutdown Supply Current	I_{QSHDN}	-	0.1	1	μA	$V_{out}=0V$, $T_a = +25^{\circ}C$

*This product is not especially designed to be protected from radioactivity.

Output-Voltage Programming

PIN Name	P1	P2	BD7003NUX		BD7004NUX	
			VOUT1	VOUT2	VOUT1	VOUT2
Set up	OPEN	OPEN	1.50	2.80	1.20	1.50
	OPEN	GND	1.80	2.60	1.20	1.80
	OPEN	VIN	1.80	2.70	1.80	1.50
	GND	OPEN	1.80	2.80	1.80	1.80
	GND	GND	1.80	2.90	1.80	3.00
	GND	VIN	2.60	2.80	1.80	3.30
	VIN	OPEN	2.80	2.80	2.80	3.00
	VIN	GND	2.90	2.90	3.00	3.00
VIN	VIN	2.80	3.30	3.30	3.30	

Output Voltage Programming Input (P1, P2)

Output voltages, VOUT1 and VOUT2, are determined at power up by the state of P1 and P2 (see the table of "Output-Voltage Programming"). Subsequent changes to P1 and P2 do not change the output voltages unless the supply power is cycled, or all EN inputs are simultaneously driven low to shutdown the device.

Shutdown (EN1, EN2)

The BD7003NUX, BD7004NUX have independent shutdown control inputs, EN1 and EN2. Driving both EN1 and EN2 low will shut down the entire device, reducing supply current to $1 \mu A$ max. Connecting EN1 and EN2 to a logic-high or VIN will enable the corresponding output(s). It is prohibited to open EN1, EN2 switches.

● Typical Application Circuit

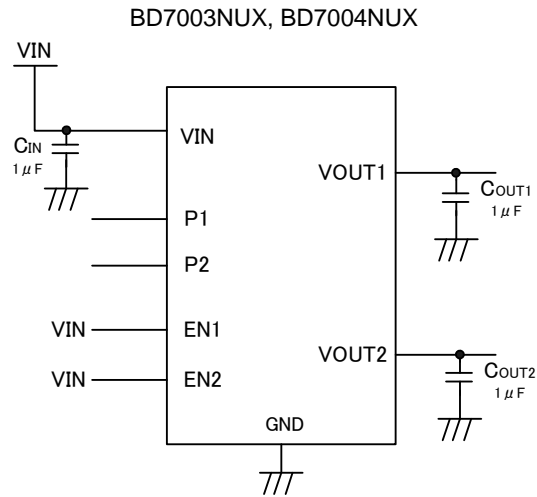
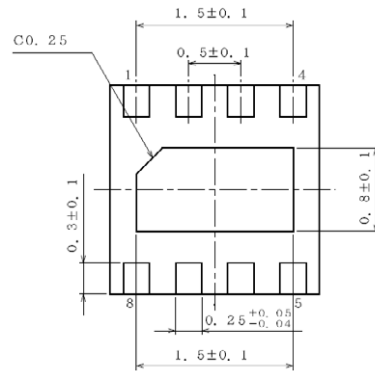
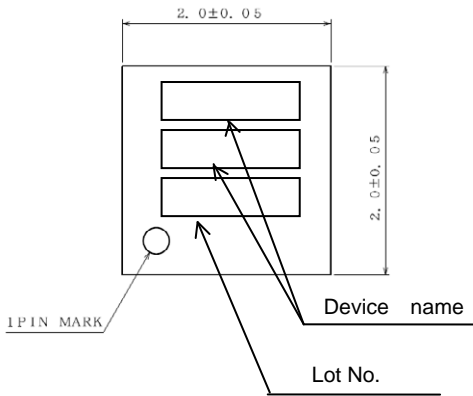

Figure2. Application Circuit

*It is prohibited to open EN1, EN2 switches.

● Package Dimensions (VSON008X2020)



[Unit: mm]

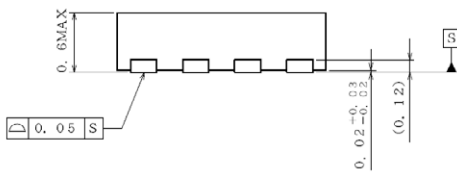

Device name	Marking
BD7003NUX	BD7003
BD7004NUX	BD7004

● Pin Descriptions

PIN description (Top View)

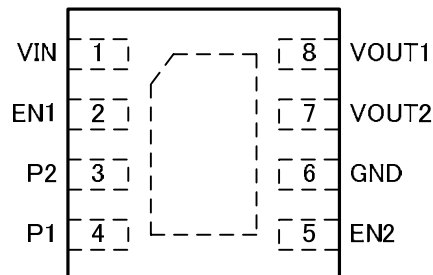

Note : Recommend connecting the Thermal Pad to the GND for excellent power dissipation.

PIN No.	Name	I/O	ESD Diode		Function
			IN	GND	
1	VIN	I	-	O	Voltage Supply
2	EN1	I	-	O	Enable Input1
3	P2	I	O	O	Control Output-Voltage PIN2
4	P1	I	O	O	Control Output-Voltage PIN1
5	EN2	I	-	O	Enable Input2
6	GND	-	O	-	GND PIN
7	VOUT2	O	-	O	LDO1 Output1
8	VOUT1	O	-	O	LDO2 Output2

●Equivalent Circuit

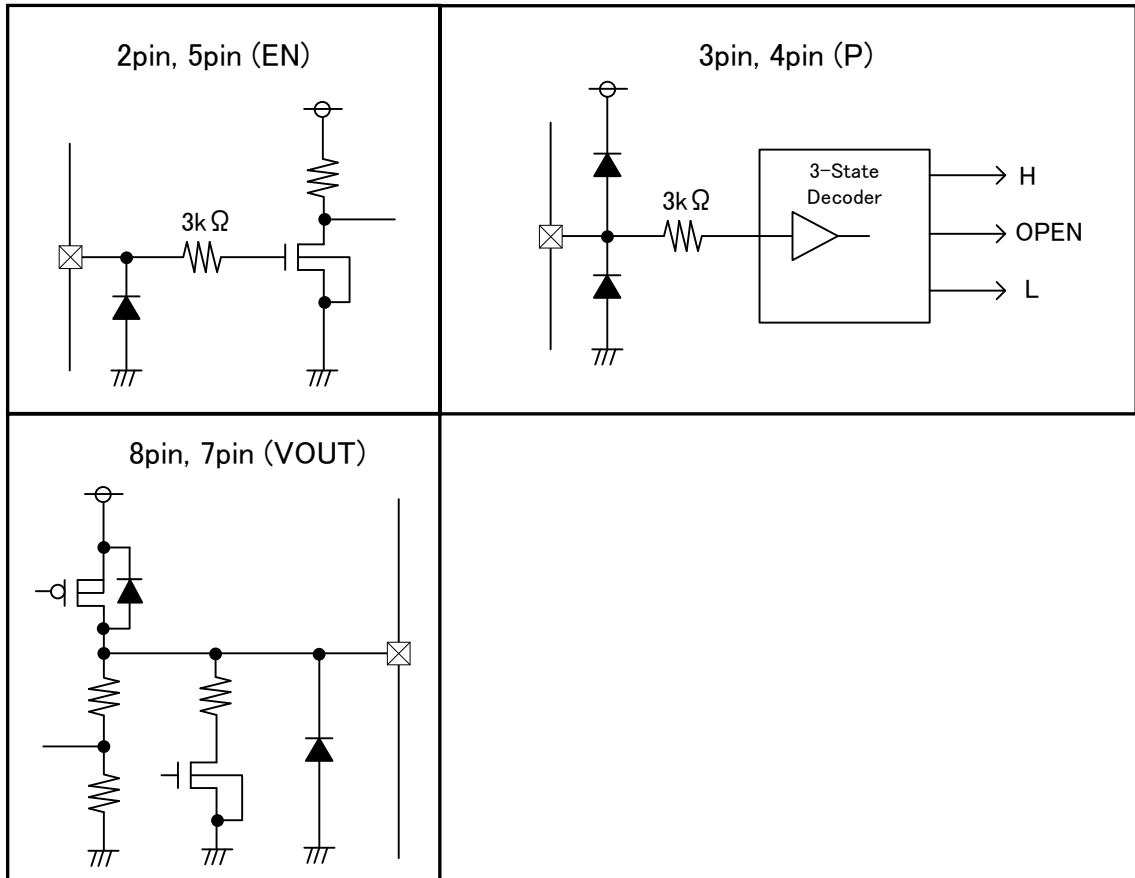

●Block Diagram

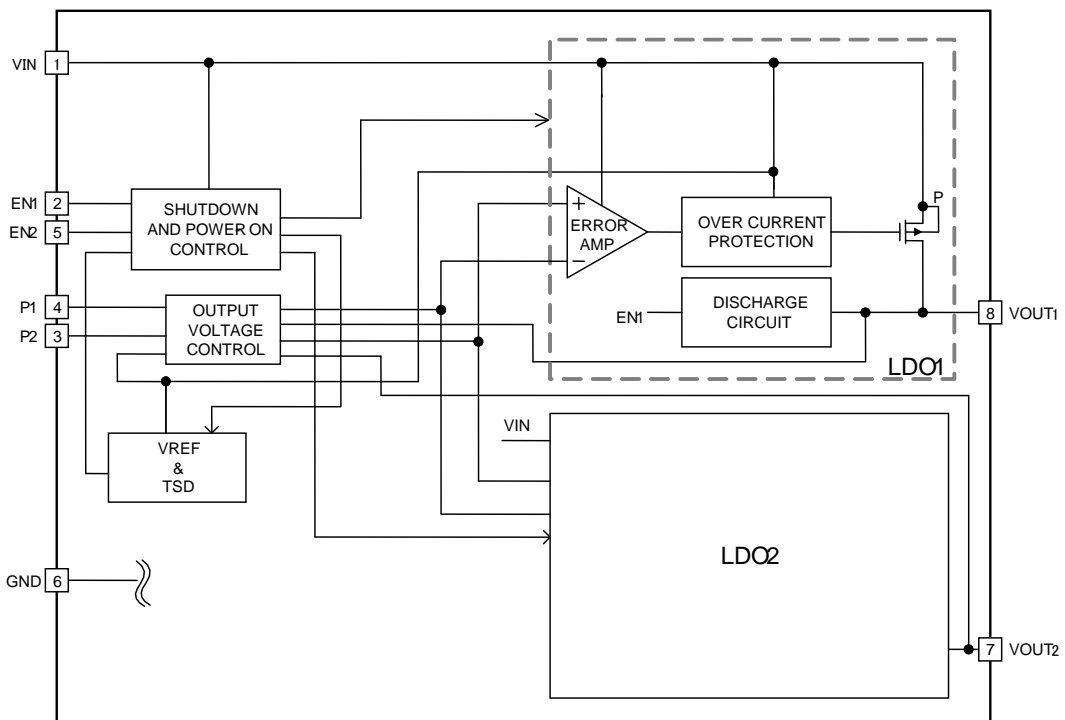

Fig.3. Block Diagram

● Typical Operating Characteristics

※The test conditions for the Typical Operating Characteristics are VIN=3.7V, CIN=1.0uF, COUT=1.0uF, Ta=25°C, Unless otherwise noted.

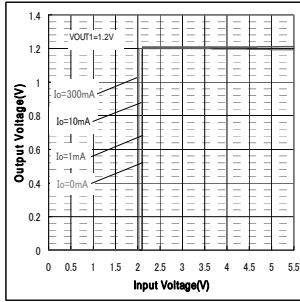

Fig.4. Output Voltage (VOUT1=1.2V)

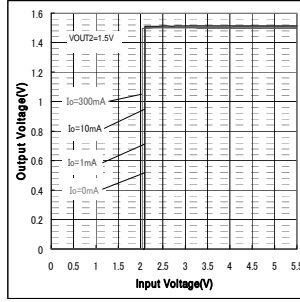

Fig.5. Output Voltage (VOUT2=1.5V)

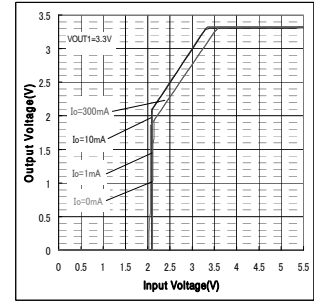

Fig.6. Output Voltage (VOUT1=3.3V)

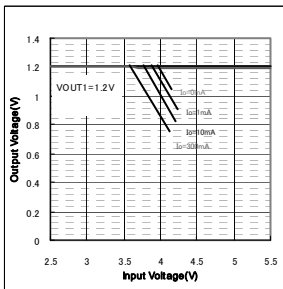

Fig.7. Line Regulation (VOUT1=1.2V)

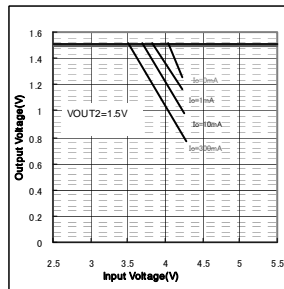

Fig.8. Line Regulation (VOUT2=1.5V)

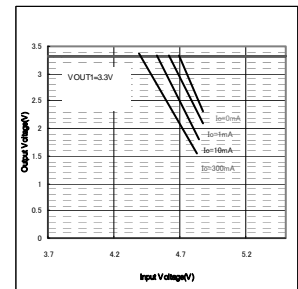

Fig.9. Line Regulation (VOUT1=3.3V)

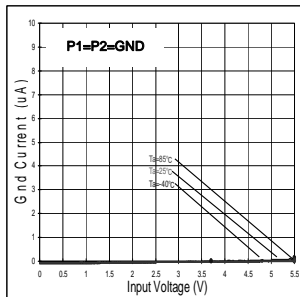

Fig.10. Circuit Current (VOUT1=1.8V, VOUT2=2.9V) EN1=EN2=GND

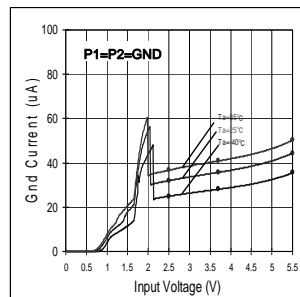

Fig.11. Circuit Current (VOUT1=1.8V, VOUT2=2.9V) EN1=VIN, EN2=GND

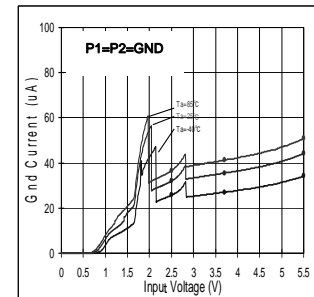

Fig.12. Circuit Current (VOUT1=1.8V, VOUT2=2.9V) EN1=GND, EN2=VIN

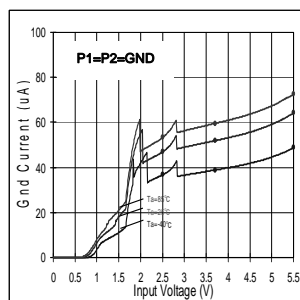

Fig.13. Circuit Current (VOUT1=1.8V, VOUT2=2.9V) EN1=EN2=VIN

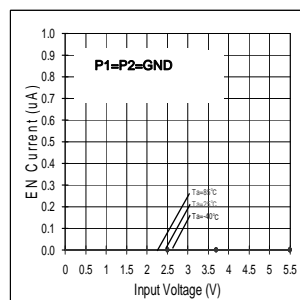

Fig.14. EN1 Input Current

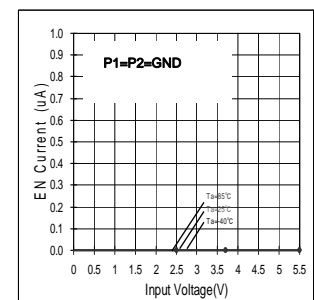

Fig.15. EN2 Input Current

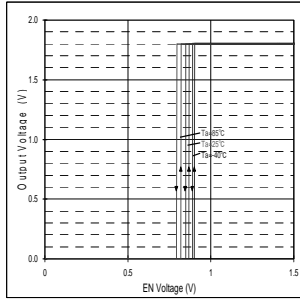

Fig.16. EN1 Threshold
(VOUT1=1.8V)

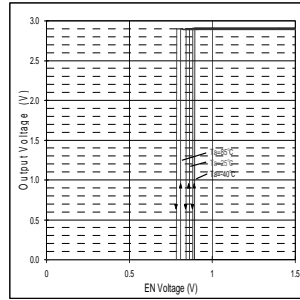

Fig.17. EN2 Threshold
(VOUT2=2.9V)

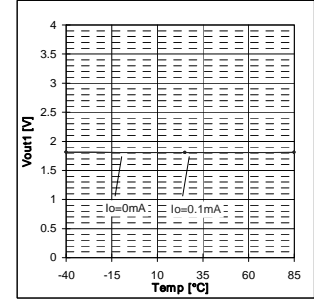

Fig.18. VOUT - Temp
(VOUT1=1.8V)

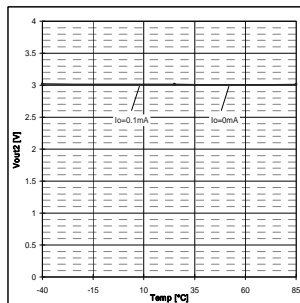

Fig.19. VOUT - Temp
(VOUT2=3.0V)

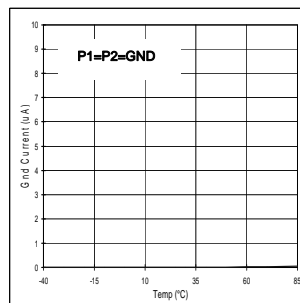

Fig.20. Icc - Temp
(VOUT1=1.8V, VOUT2=2.9V)
EN1=EN2=GND

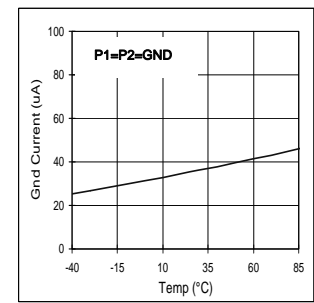

Fig.21. Icc - Temp
(VOUT1=1.8V, VOUT2=2.9V)
EN1=VIN, EN2=GND

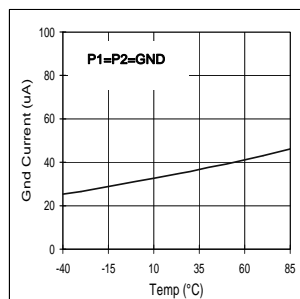

Fig.22. Icc - Temp
(VOUT1=1.8V, VOUT2=2.9V)
EN1=GND, EN2=VIN

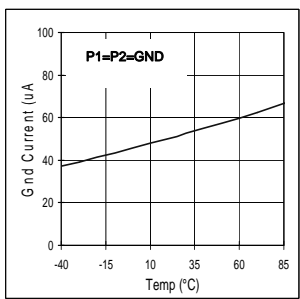

Fig.23. Icc - Temp
(VOUT1=1.8V, VOUT2=2.9V)
EN1=EN2=VIN

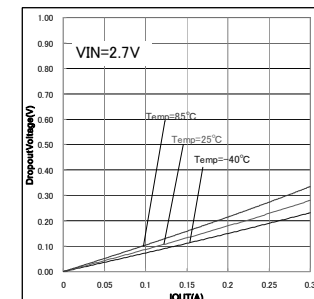

Fig.24. Drop Out Voltage
(VOUT1=2.8V)

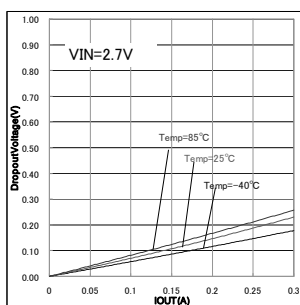

Fig.25. Drop Out Voltage
(VOUT2=2.8V)

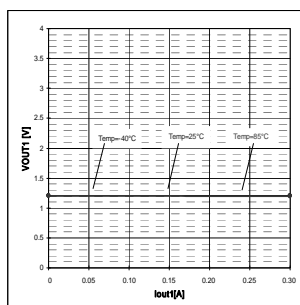

Fig.26. Load Regulation
(VOUT1=1.2V)

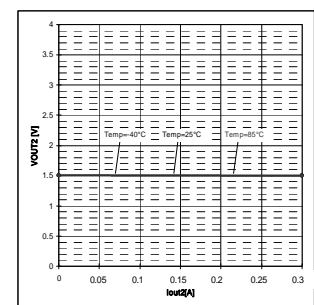

Fig.27. Load Regulation
(VOUT2=1.5V)

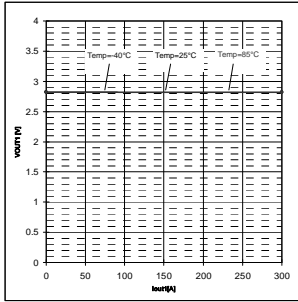

Fig.28. Load Regulation (VOUT1=2.8V)

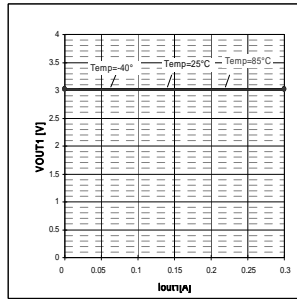

Fig.29. Load Regulation (VOUT2=3.0V)

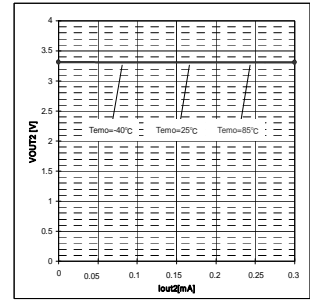

Fig.30. Load Regulation (VOUT2=3.3V)

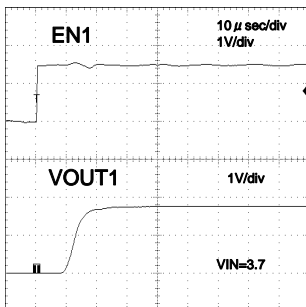

Fig.31. Start Up Time (VOUT1=1.8V) IOUT=0mA

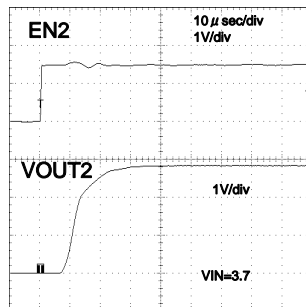

Fig.32. Start Up Time (VOUT2=2.9V) IOUT=0mA

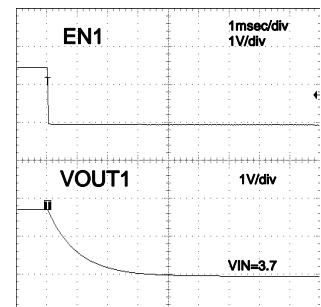

Fig.33. Discharge Time (VOUT1=1.8V) IOUT=0mA

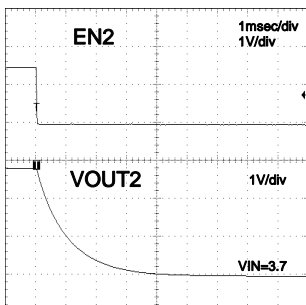

Fig.34. Discharge Time (VOUT2=2.9V) IOUT=0mA

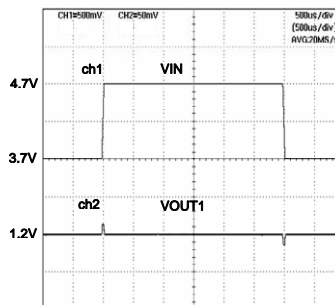

Fig.35. VIN Response (VOUT1=1.2V) IOUT=50mA

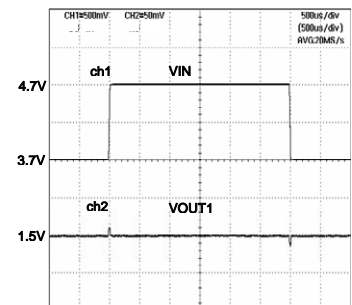

Fig.36. VIN Response (VOUT1=1.5V) IOUT=50mA

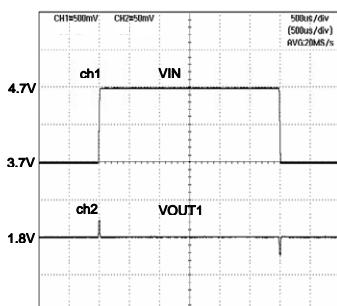

Fig.37. VIN Response (VOUT1=1.8V) IOUT=50mA

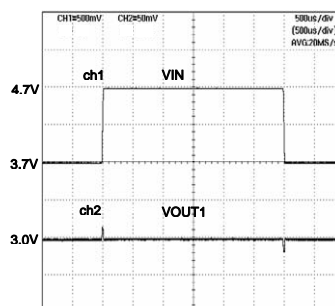

Fig.38. VIN Response (VOUT2=3.0V) IOUT=50mA

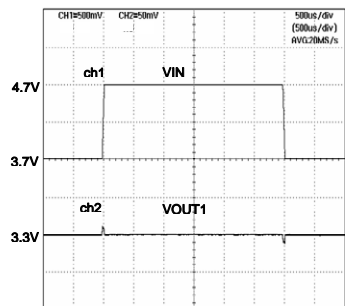

Fig.39. VIN Response (VOUT2=3.3V) IOUT=50mA

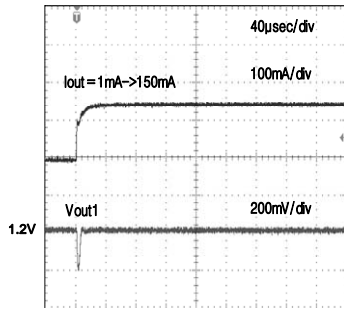

Fig.40. Load Response
(VOUT1=1.2V)
IOUT=1mA→150mA

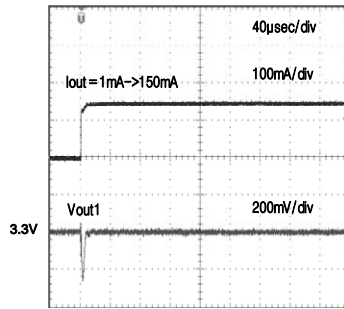

Fig.41. Load Response
(VOUT1=3.3V)
IOUT=1mA→150mA

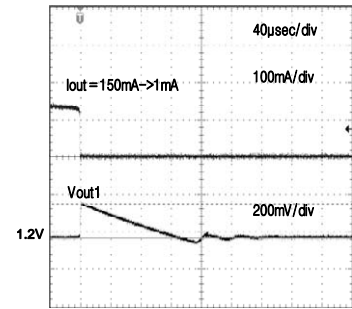

Fig.42. Load Response
(VOUT1=1.2V)
IOUT=150mA→1mA

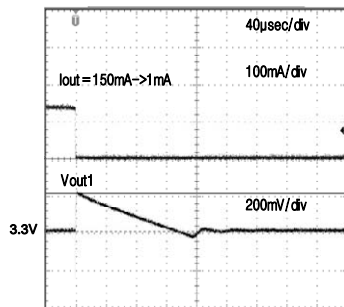

Fig.43. Load Response
(VOUT1=3.3V)
IOUT=150mA→1mA

● Example of EN1&EN2 used (P1=GND, P2=OPEN, VOUT1=1.8V, VOUT2=2.8V)

Output overshoot conditions

Whenever the LDO is turned ON, LDO1 output overshoot occurs in certain boot conditions.

In CASE2, the overshoot value is minimum, which boot order is EN1→EN2.

The maximum overshoot occurs in CASE3, which boot order is EN2→EN1.

The overshoot value differs between input voltages(VIN), output voltage setting and EN1, EN2 input timing interval.

CASE1: EN1 & EN2 Pins are shorted

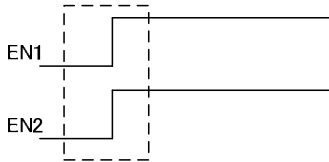

VIN=3.7V, EN2=EN1

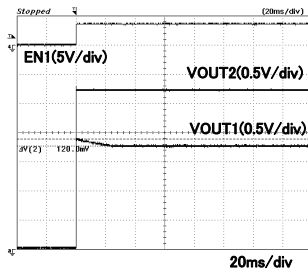

VIN=5.5V, EN2=EN1

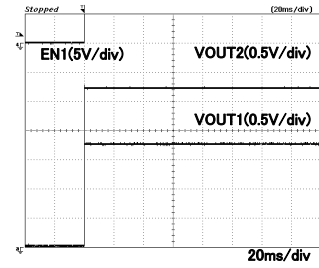

EN1 & EN2 Pins are independent

CASE2: EN1→EN2 operation(L→H)

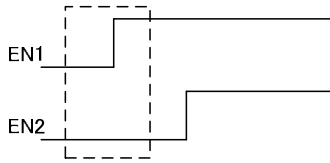

VIN=3.7V, EN2=L(OFF)

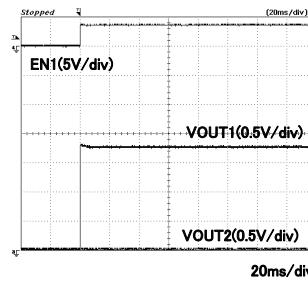

VIN=5.5V, EN2=L(OFF)

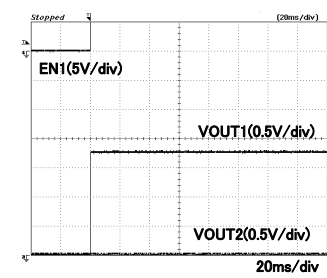

CASE3: EN2→EN1 operation(L→H)

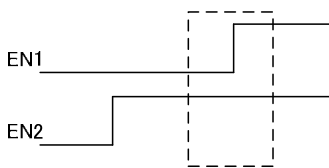

VIN=3.7V, EN2=H(ON)

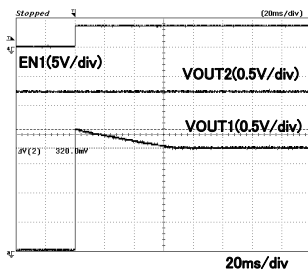

VIN=5.5V, EN2=H(ON)

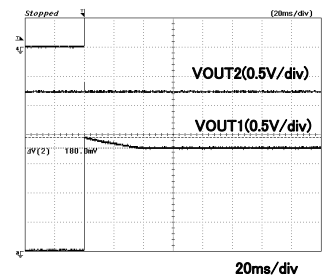

●Notes for use

- (1) Absolute maximum ratings
If applied voltage (VIN), operating temperature range (Topr), or other absolute maximum ratings are exceeded, there is a risk of damage. Since it is not possible to identify short, open, or other damage modes, if special modes in which absolute maximum ratings are exceeded are assumed, consider applying fuses or other physical safety measures.
- (2) Recommended operating range
This is the range within which it is possible to obtain roughly the expected characteristics. For electrical characteristics, it is those that are guaranteed under the conditions for each parameter. Even when these are within the recommended operating range, voltage and temperature characteristics are indicated.
- (3) Reverse connection of power supply connector
There is a risk of damaging the IC by reverse connection of the power supply connector. For protection from reverse connection, take measures such as externally placing a diode between the power supply and the power supply pin of the IC.
- (4) Power supply lines
In the design of the board pattern, make power supply and GND line wiring low impedance. When doing so, although the digital power supply and analog power supply are the same potential, separate the digital power supply pattern and analog power supply pattern to deter digital noise from entering the analog power supply due to the common impedance of the wiring patterns. Similarly take pattern design into account for GND lines as well. Furthermore, for all power supply pins of the IC, in conjunction with inserting capacitors between power supply and GND pins, when using electrolytic capacitors, determine constants upon adequately confirming that capacitance loss occurring at low temperatures is not a problem for various characteristics of the capacitors used.
- (5) GND voltage
Make the potential of a GND pin such that it will be the lowest potential even if operating below that. In addition, confirm that there are no pins for which the potential becomes less than a GND by actually including transition phenomena.
- (6) Shorts between pins and misinstallation
When installing in the set board, pay adequate attention to orientation and placement discrepancies of the IC. If it is installed erroneously, there is a risk of IC damage. There also is a risk of damage if it is shorted by a foreign substance getting between pins, between a pin and a power supply or GND.
- (7) Operation in strong magnetic fields
Be careful when using the IC in a strong magnetic field, since it may malfunction.
- (8) Inspection in set board
When inspecting the IC in the set board, since there is a risk of stress to the IC when capacitors are connected to low impedance IC pins, be sure to discharge for each process. Moreover, when getting it on and off of a jig in the inspection process, always connect it after turning off the power supply, perform the inspection, and remove it after turning off the power supply. Furthermore, as countermeasures against static electricity, use grounding in the assembly process and take appropriate care in transport and storage.
- (9) Input pins
Parasitic elements inevitably are formed on an IC structure due to potential relationships. Because parasitic elements operate, they give rise to interference with circuit operation and may be the cause of malfunctions as well as damage. Accordingly, take care not to apply a lower voltage than GND to an input pin or use the IC in other ways such that parasitic elements operate. Moreover, do not apply a voltage to an input pin when the power supply voltage is not being applied to the IC. Furthermore, when the power supply voltage is being applied, make each input pin a voltage less than the power supply voltage as well as within the guaranteed values of electrical characteristics.
- (10) Ground wiring pattern
When there is a small signal GND and a large current GND, it is recommended that you separate the large current GND pattern and small signal GND pattern and provide single point grounding at the reference point of the set so that voltage variation due to resistance components of the pattern wiring and large currents do not cause the small signal GND voltage to change. Take care that the GND wiring pattern of externally attached components also does not change.
- (11) Externally attached capacitors
When using ceramic capacitors for externally attached capacitors, determine constants upon taking into account a lowering of the rated capacitance due to DC bias and capacitance change due to factors such as temperature.
- (12) Thermal shutdown circuit (TSD)
When the junction temperature becomes 180°C (typ) or higher, the thermal shutdown circuit operates and turns the switch OFF. The thermal shutdown circuit, which is aimed at isolating the IC from thermal runaway as much as possible, is not aimed at the protection or guarantee of the IC. Therefore, do not continuously use the IC with this circuit operating or use the IC assuming its operation.
- (13) Thermal design
Perform thermal design in which there are adequate margins by taking into account the permissible dissipation (Pd) in actual states of use.

●Ordering part number

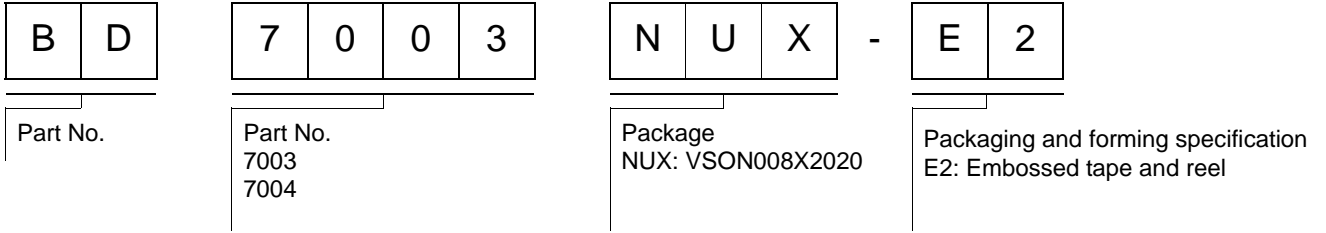

VSON008X2020

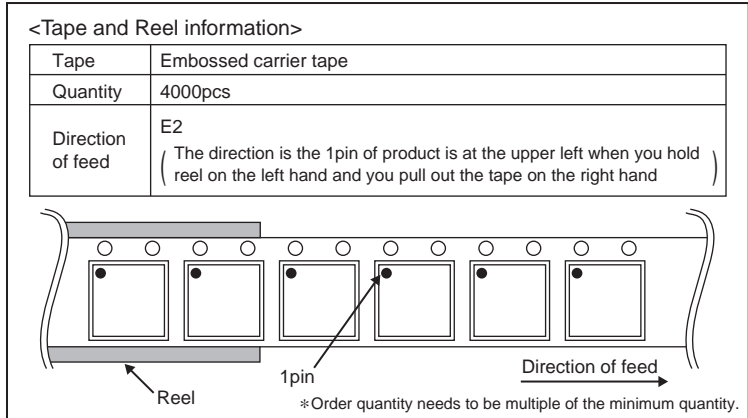
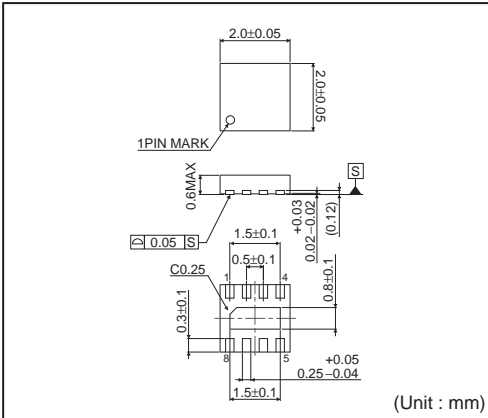

Notice

Precaution on using ROHM Products

- Our Products are designed and manufactured for application in ordinary electronic equipments (such as AV equipment, OA equipment, telecommunication equipment, home electronic appliances, amusement equipment, etc.). If you intend to use our Products in devices requiring extremely high reliability (such as medical equipment ^(Note 1), transport equipment, traffic equipment, aircraft/spacecraft, nuclear power controllers, fuel controllers, car equipment including car accessories, safety devices, etc.) and whose malfunction or failure may cause loss of human life, bodily injury or serious damage to property ("Specific Applications"), please consult with the ROHM sales representative in advance. Unless otherwise agreed in writing by ROHM in advance, ROHM shall not be in any way responsible or liable for any damages, expenses or losses incurred by you or third parties arising from the use of any ROHM's Products for Specific Applications.

(Note1) Medical Equipment Classification of the Specific Applications

JAPAN	USA	EU	CHINA
CLASS III	CLASS III	CLASS II b	CLASS III
CLASS IV		CLASS III	

- ROHM designs and manufactures its Products subject to strict quality control system. However, semiconductor products can fail or malfunction at a certain rate. Please be sure to implement, at your own responsibilities, adequate safety measures including but not limited to fail-safe design against the physical injury, damage to any property, which a failure or malfunction of our Products may cause. The following are examples of safety measures:
 - Installation of protection circuits or other protective devices to improve system safety
 - Installation of redundant circuits to reduce the impact of single or multiple circuit failure
- Our Products are designed and manufactured for use under standard conditions and not under any special or extraordinary environments or conditions, as exemplified below. Accordingly, ROHM shall not be in any way responsible or liable for any damages, expenses or losses arising from the use of any ROHM's Products under any special or extraordinary environments or conditions. If you intend to use our Products under any special or extraordinary environments or conditions (as exemplified below), your independent verification and confirmation of product performance, reliability, etc. prior to use, must be necessary:
 - Use of our Products in any types of liquid, including water, oils, chemicals, and organic solvents
 - Use of our Products outdoors or in places where the Products are exposed to direct sunlight or dust
 - Use of our Products in places where the Products are exposed to sea wind or corrosive gases, including Cl₂, H₂S, NH₃, SO₂, and NO₂
 - Use of our Products in places where the Products are exposed to static electricity or electromagnetic waves
 - Use of our Products in proximity to heat-producing components, plastic cords, or other flammable items
 - Sealing or coating our Products with resin or other coating materials
 - Use of our Products without cleaning residue of flux (even if you use no-clean type fluxes, cleaning residue of flux is recommended); or Washing our Products by using water or water-soluble cleaning agents for cleaning residue after soldering
 - Use of the Products in places subject to dew condensation
- The Products are not subject to radiation-proof design.
- Please verify and confirm characteristics of the final or mounted products in using the Products.
- In particular, if a transient load (a large amount of load applied in a short period of time, such as pulse. is applied, confirmation of performance characteristics after on-board mounting is strongly recommended. Avoid applying power exceeding normal rated power; exceeding the power rating under steady-state loading condition may negatively affect product performance and reliability.
- De-rate Power Dissipation (Pd) depending on Ambient temperature (Ta). When used in sealed area, confirm the actual ambient temperature.
- Confirm that operation temperature is within the specified range described in the product specification.
- ROHM shall not be in any way responsible or liable for failure induced under deviant condition from what is defined in this document.

Precaution for Mounting / Circuit board design

- When a highly active halogenous (chlorine, bromine, etc.) flux is used, the residue of flux may negatively affect product performance and reliability.
- In principle, the reflow soldering method must be used; if flow soldering method is preferred, please consult with the ROHM representative in advance.

For details, please refer to ROHM Mounting specification

Precautions Regarding Application Examples and External Circuits

1. If change is made to the constant of an external circuit, please allow a sufficient margin considering variations of the characteristics of the Products and external components, including transient characteristics, as well as static characteristics.
2. You agree that application notes, reference designs, and associated data and information contained in this document are presented only as guidance for Products use. Therefore, in case you use such information, you are solely responsible for it and you must exercise your own independent verification and judgment in the use of such information contained in this document. ROHM shall not be in any way responsible or liable for any damages, expenses or losses incurred by you or third parties arising from the use of such information.

Precaution for Electrostatic

This Product is electrostatic sensitive product, which may be damaged due to electrostatic discharge. Please take proper caution in your manufacturing process and storage so that voltage exceeding the Products maximum rating will not be applied to Products. Please take special care under dry condition (e.g. Grounding of human body / equipment / solder iron, isolation from charged objects, setting of ionizer, friction prevention and temperature / humidity control).

Precaution for Storage / Transportation

1. Product performance and soldered connections may deteriorate if the Products are stored in the places where:
 - [a] the Products are exposed to sea winds or corrosive gases, including Cl₂, H₂S, NH₃, SO₂, and NO₂
 - [b] the temperature or humidity exceeds those recommended by ROHM
 - [c] the Products are exposed to direct sunshine or condensation
 - [d] the Products are exposed to high Electrostatic
2. Even under ROHM recommended storage condition, solderability of products out of recommended storage time period may be degraded. It is strongly recommended to confirm solderability before using Products of which storage time is exceeding the recommended storage time period.
3. Store / transport cartons in the correct direction, which is indicated on a carton with a symbol. Otherwise bent leads may occur due to excessive stress applied when dropping of a carton.
4. Use Products within the specified time after opening a humidity barrier bag. Baking is required before using Products of which storage time is exceeding the recommended storage time period.

Precaution for Product Label

QR code printed on ROHM Products label is for ROHM's internal use only.

Precaution for Disposition

When disposing Products please dispose them properly using an authorized industry waste company.

Precaution for Foreign Exchange and Foreign Trade act

Since our Products might fall under controlled goods prescribed by the applicable foreign exchange and foreign trade act, please consult with ROHM representative in case of export.

Precaution Regarding Intellectual Property Rights

1. All information and data including but not limited to application example contained in this document is for reference only. ROHM does not warrant that foregoing information or data will not infringe any intellectual property rights or any other rights of any third party regarding such information or data. ROHM shall not be in any way responsible or liable for infringement of any intellectual property rights or other damages arising from use of such information or data.:
2. No license, expressly or implied, is granted hereby under any intellectual property rights or other rights of ROHM or any third parties with respect to the information contained in this document.

Other Precaution

1. This document may not be reprinted or reproduced, in whole or in part, without prior written consent of ROHM.
2. The Products may not be disassembled, converted, modified, reproduced or otherwise changed without prior written consent of ROHM.
3. In no event shall you use in any way whatsoever the Products and the related technical information contained in the Products or this document for any military purposes, including but not limited to, the development of mass-destruction weapons.
4. The proper names of companies or products described in this document are trademarks or registered trademarks of ROHM, its affiliated companies or third parties.

General Precaution

1. Before you use our Products, you are requested to carefully read this document and fully understand its contents. ROHM shall not be in any way responsible or liable for failure, malfunction or accident arising from the use of any ROHM's Products against warning, caution or note contained in this document.
2. All information contained in this document is current as of the issuing date and subject to change without any prior notice. Before purchasing or using ROHM's Products, please confirm the latest information with a ROHM sales representative.
3. The information contained in this document is provided on an "as is" basis and ROHM does not warrant that all information contained in this document is accurate and/or error-free. ROHM shall not be in any way responsible or liable for any damages, expenses or losses incurred by you or third parties resulting from inaccuracy or errors of or concerning such information.